



HAL
open science

Mobilities in high-quality CVD diamond crystals evaluated by time-offlight measurements: experimental and simulation results

Audrey Valentin, V Mille, A Tallaire, J Achard, A Gicquel

► **To cite this version:**

Audrey Valentin, V Mille, A Tallaire, J Achard, A Gicquel. Mobilities in high-quality CVD diamond crystals evaluated by time-offlight measurements: experimental and simulation results. Surface and Bulk Defects in Diamond (SBDD) XVIII, Mar 2013, Hasselt, Belgium. hal-03578219

HAL Id: hal-03578219

<https://cnrs.hal.science/hal-03578219>

Submitted on 17 Feb 2022

HAL is a multi-disciplinary open access archive for the deposit and dissemination of scientific research documents, whether they are published or not. The documents may come from teaching and research institutions in France or abroad, or from public or private research centers.

L'archive ouverte pluridisciplinaire **HAL**, est destinée au dépôt et à la diffusion de documents scientifiques de niveau recherche, publiés ou non, émanant des établissements d'enseignement et de recherche français ou étrangers, des laboratoires publics ou privés.

Abstract

Diamond is a promising candidate for power electronics as well as for radiation detection¹. In both cases, device optimization requires an accurate knowledge of electron and hole mobilities.

In this study, time-of-flight (TOF) experiments were performed on intrinsic CVD diamond crystals to determine carrier mobilities. Electron-hole pairs were generated in a biased diamond layer by α rays. The resulting current peak was amplified and measured.

The distribution of electron-hole pairs in the sample has also been studied by means of simulation with SRIM and Geant4. This distribution has then been used to simulate the charge transport in the diamond. A drift-diffusion model, coupled with Poisson's equation, was implemented in COMSOL. These simulation tools have been used to optimize the sample and experimental setup geometry.

Radiation effect modelling

Particle ranges have been calculated with SRIM. The full energy deposition profile have been calculated with Geant4 (with the Livermore energy model) which takes into account secondary electrons.

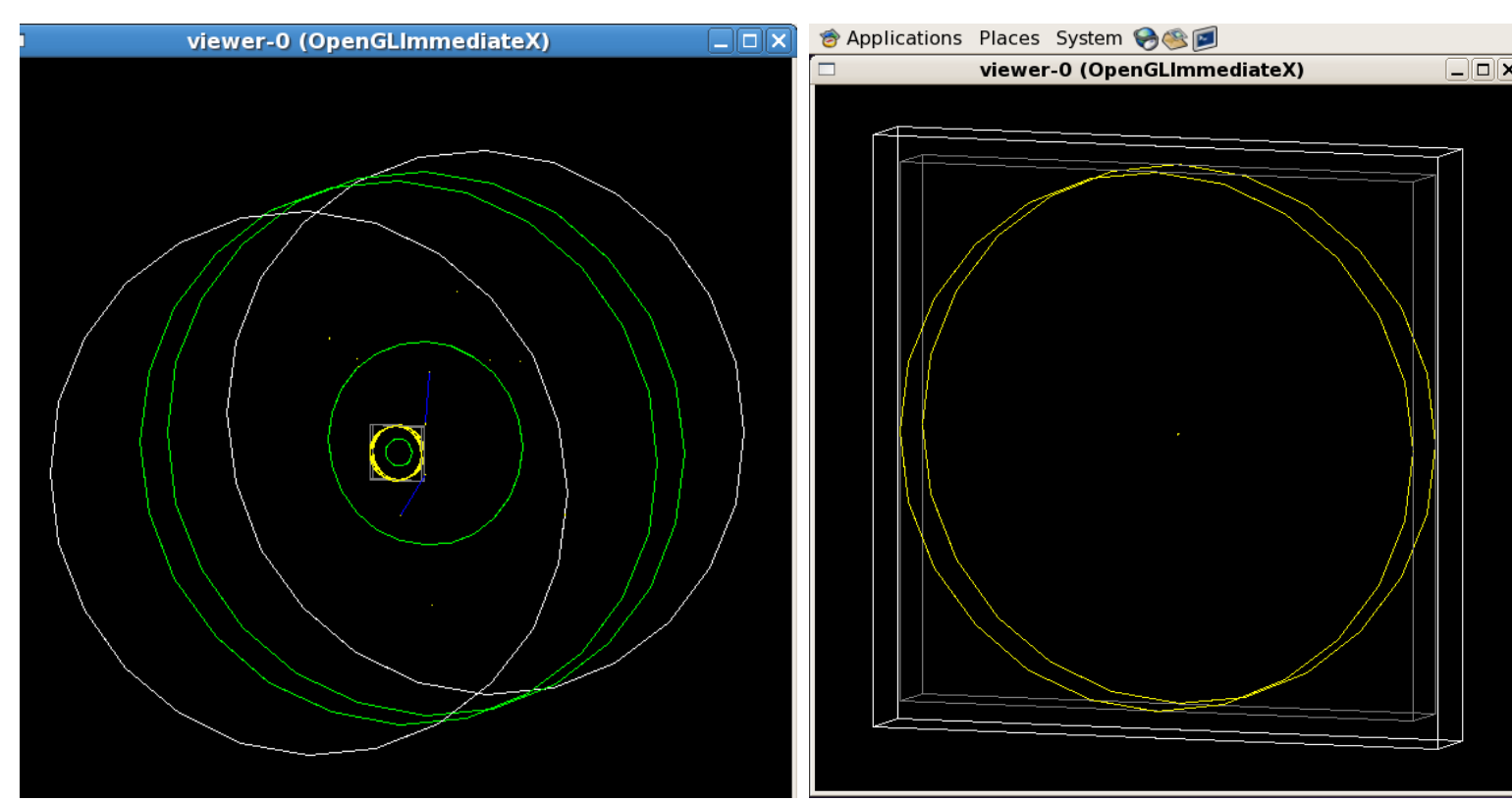

Full geometry of the sample holder (green), with the sample (diamond in gray, Al in yellow) modeled in Geant4.

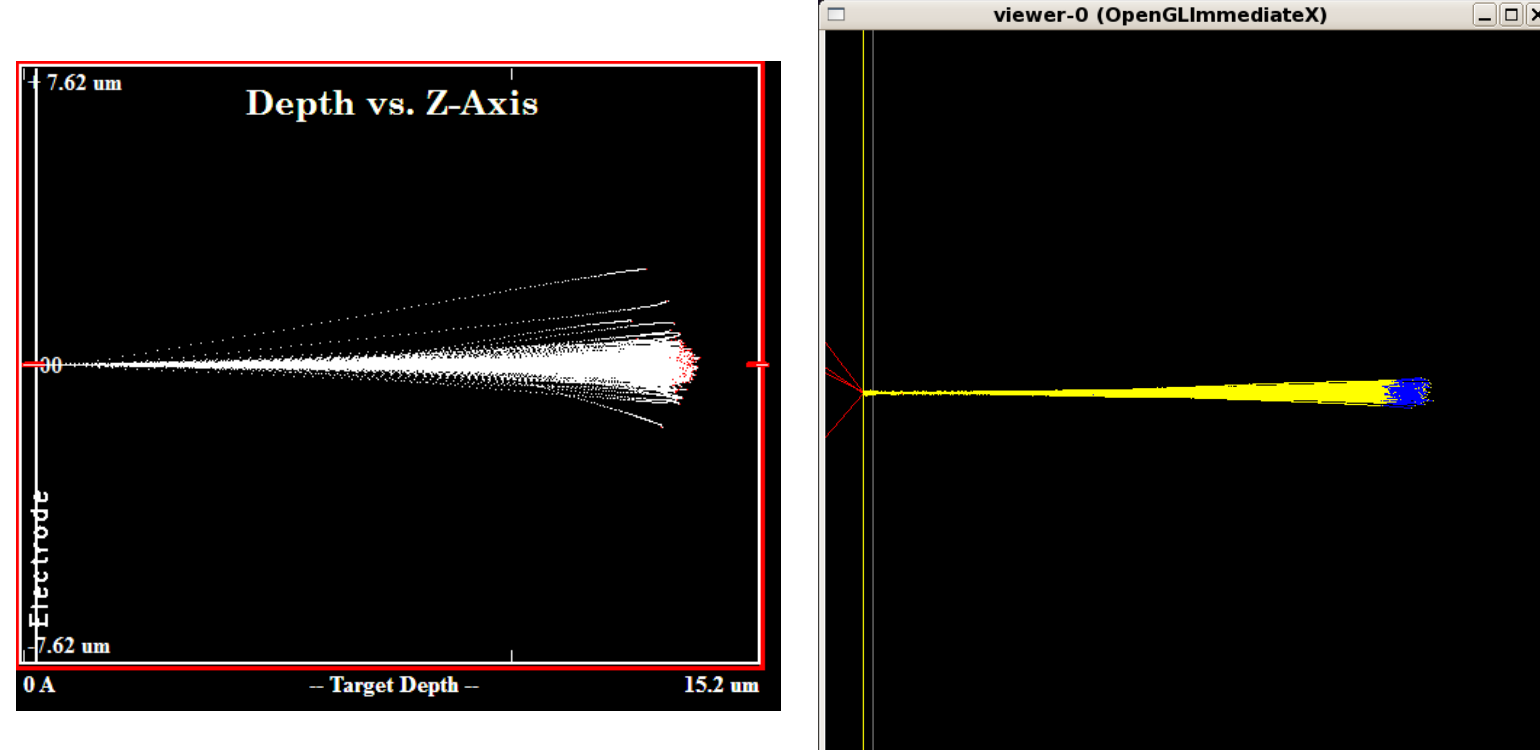

Tracks of 100 α -rays calculated with SRIM (left) and Geant4 (right), with α particles in yellow and secondary electrons in blue.

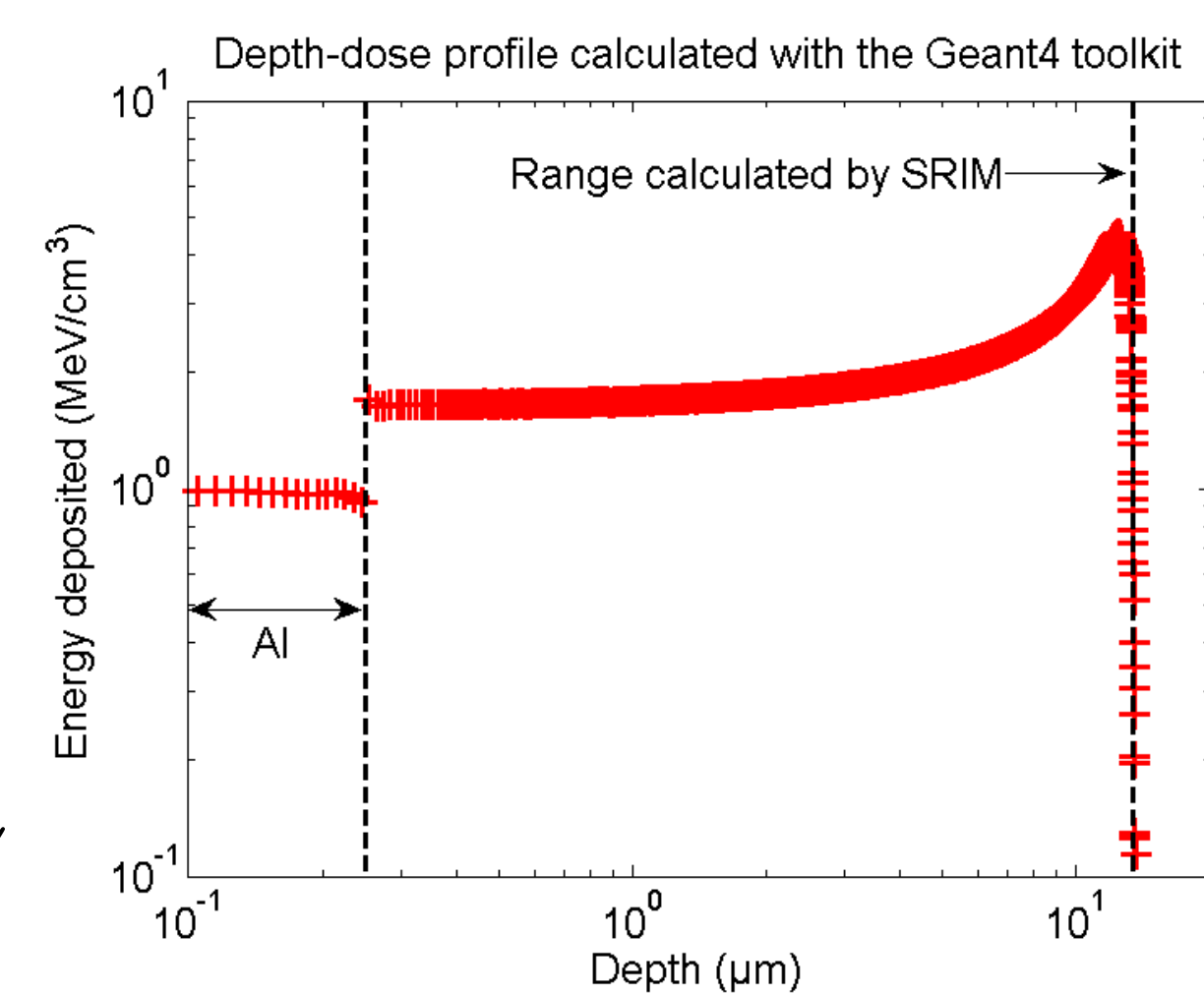
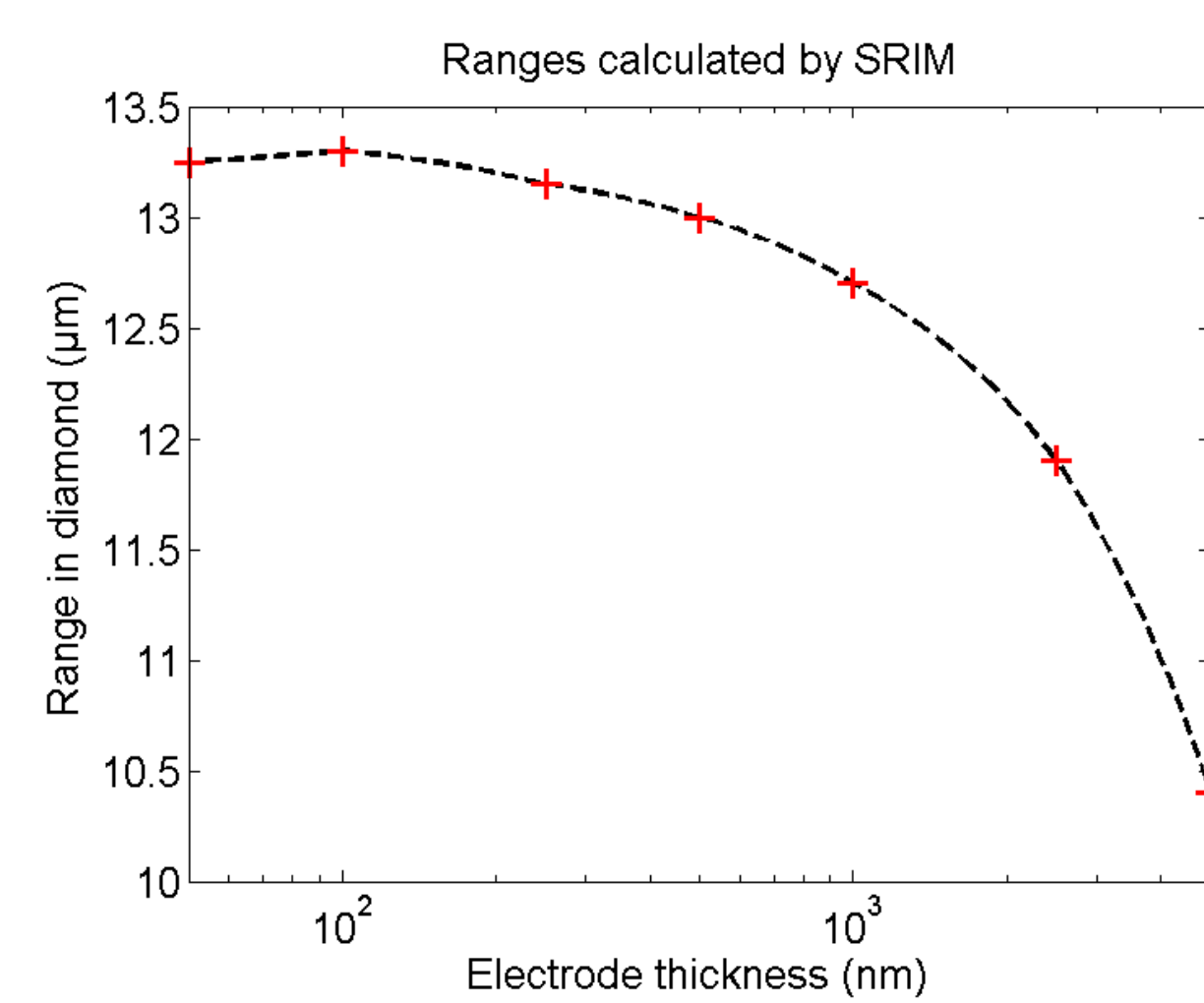

Results obtained with a 250 nm-thick Al electrode:

- Range = 13.4 μm
- 99.3 % of the energy is deposited in the diamond layer
- 0.4 % of α particles hit the diamond

Charge transport modelling

A drift-diffusion model has been used to study the charge transport in diamond. The drift-diffusion equations coupled to Poisson's equation are solved with COMSOL.

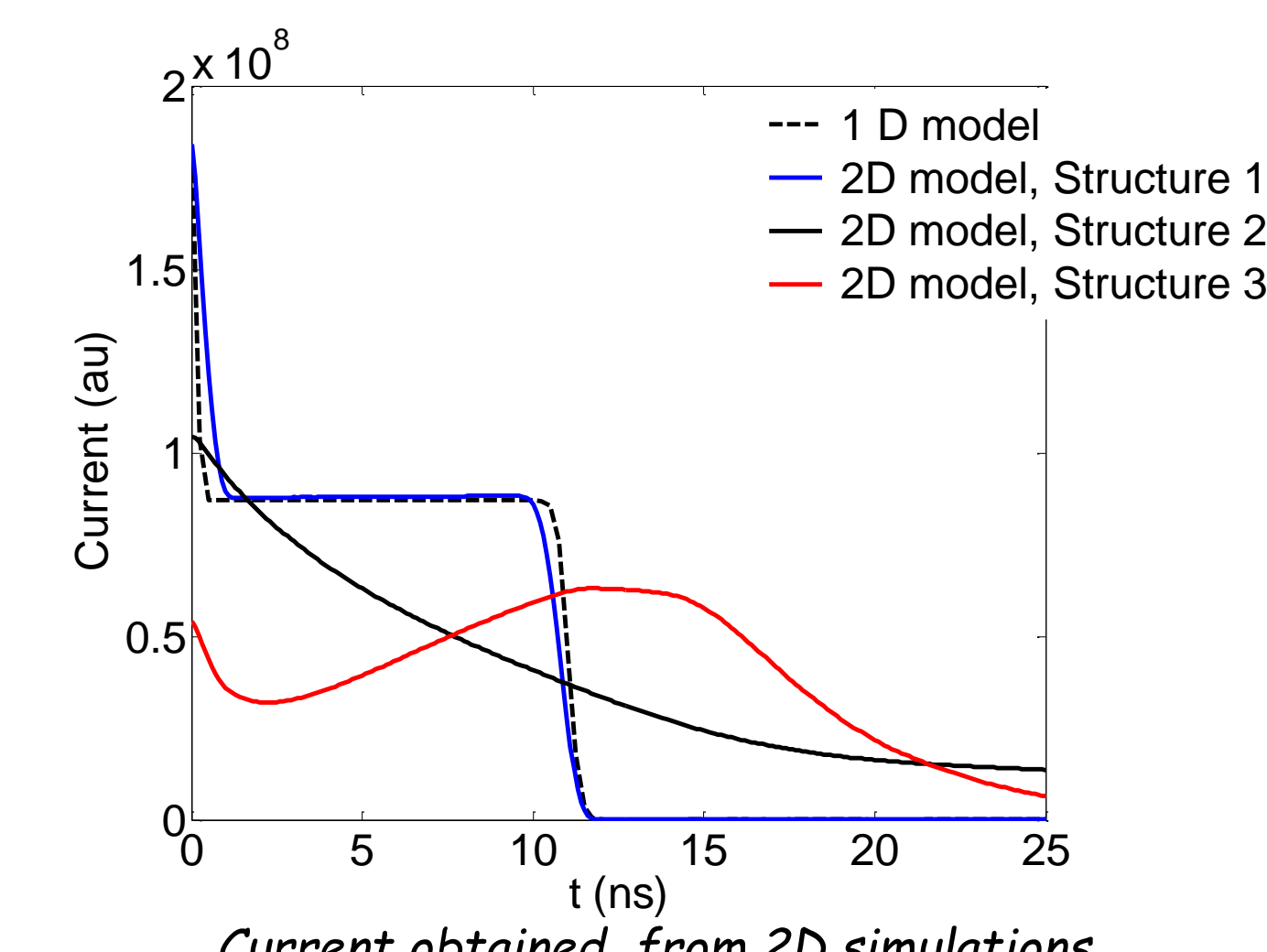
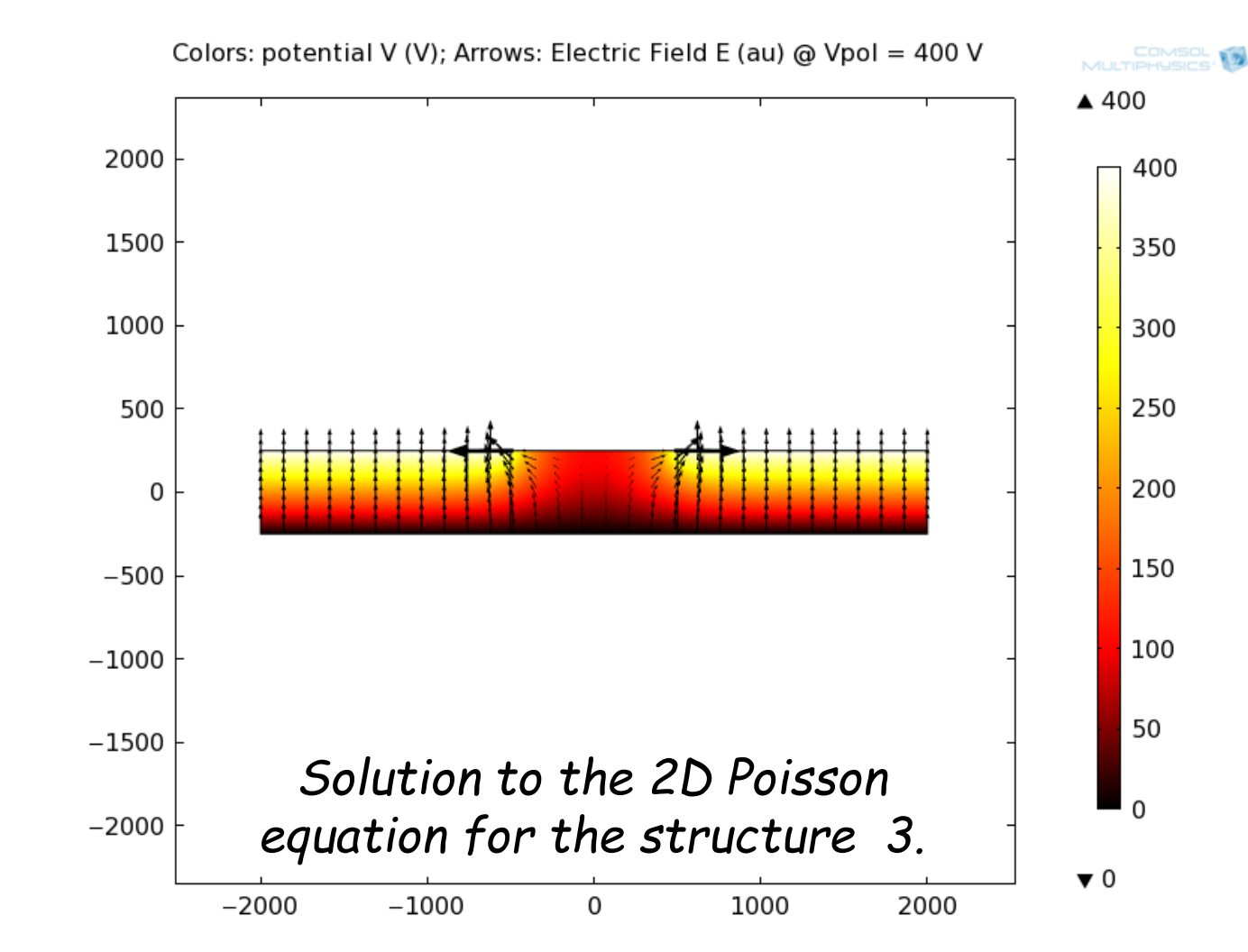
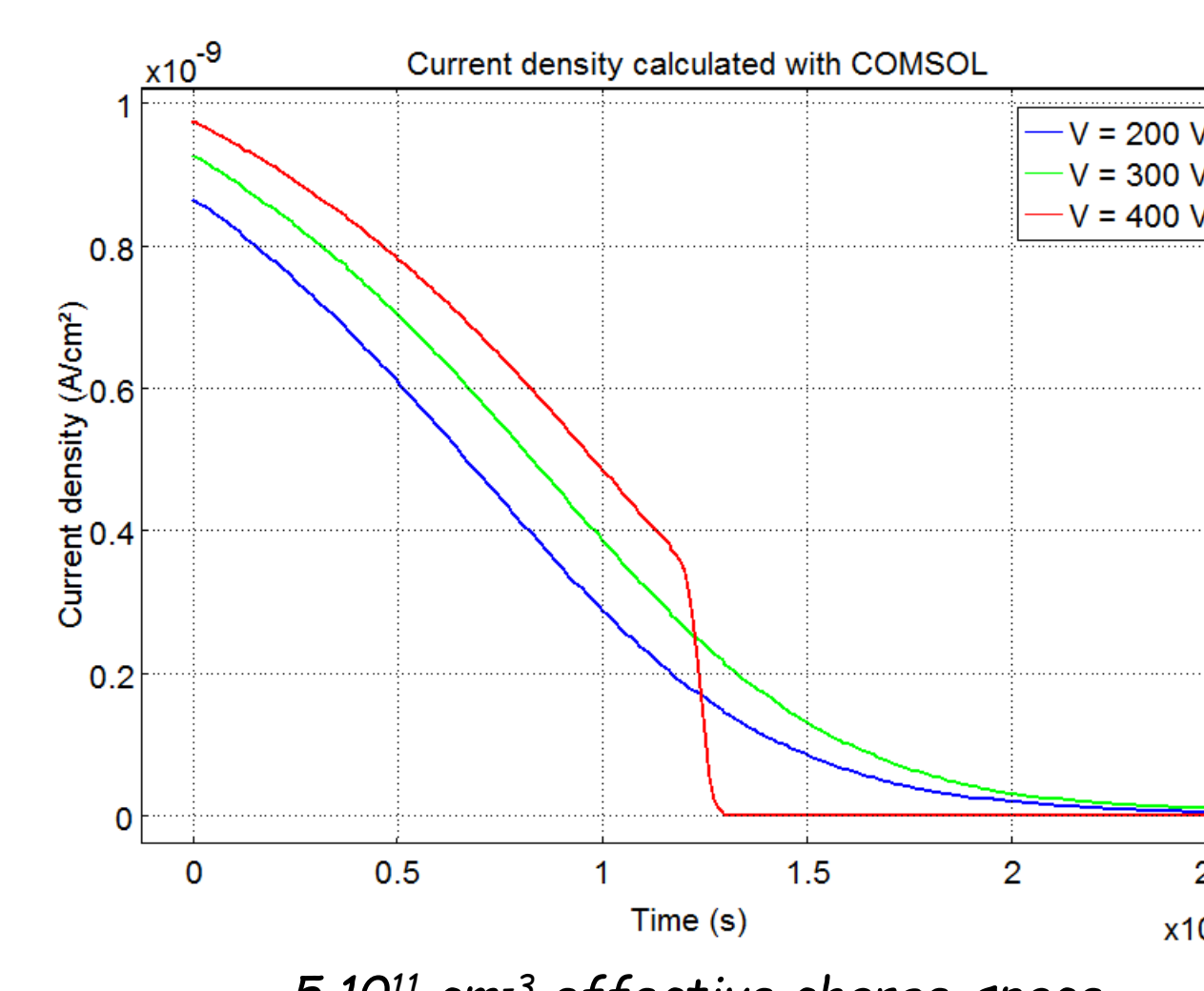
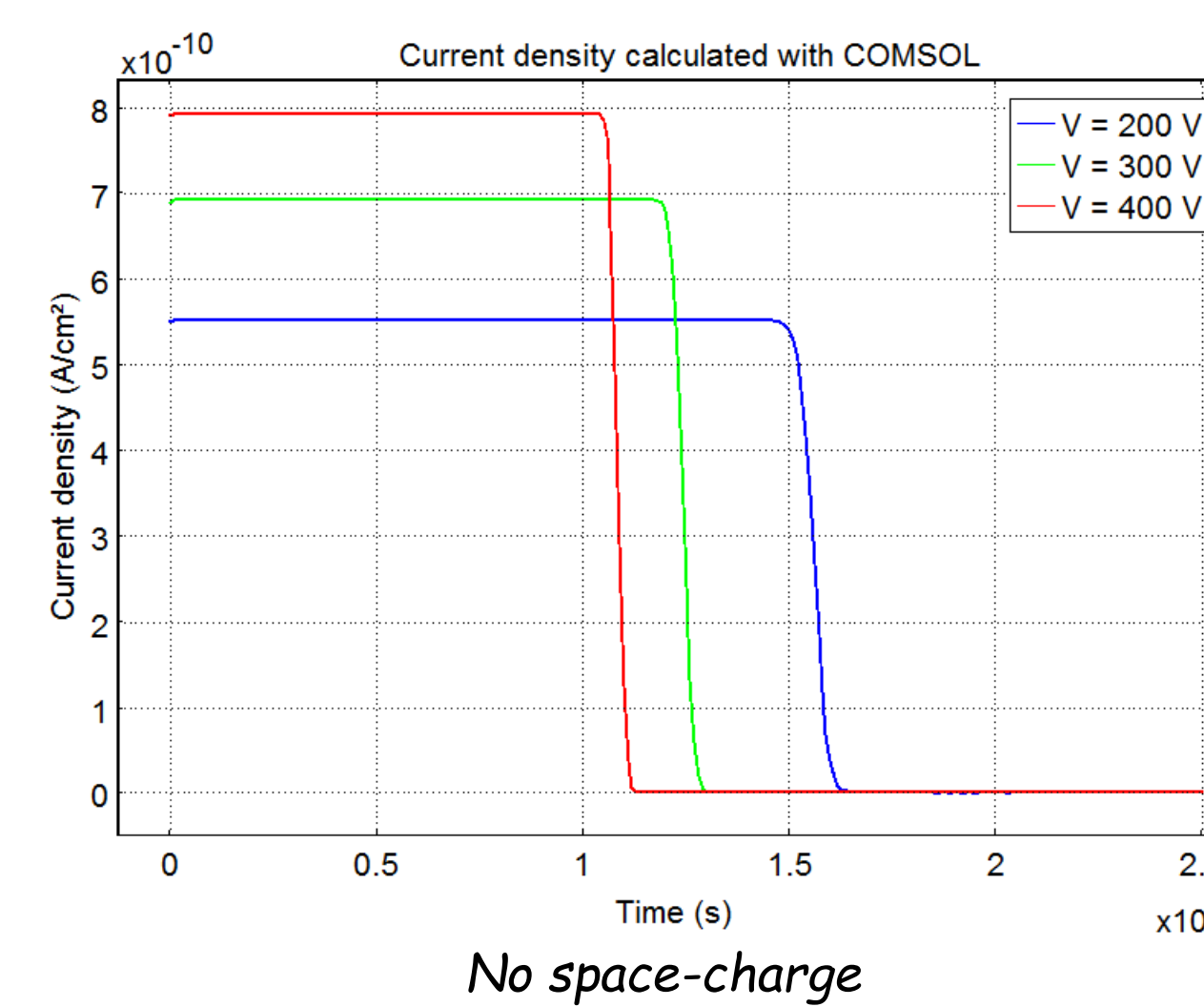

Results:

- the presence of a space-charge bends the current peak
- a hole in the electrode degrades the electric potential repartition..

Time-of-Flight measurements

Electron-hole pairs are generated on one side of the sample with alpha rays from an ²⁴¹Am source.

The sample is biased with a Keithley 6487 used as a DC voltage generator to collect electrons and holes and the obtained current is amplified by a DBA-IV/R device. The amplified current is finally measured with a Tektronix TDS300 oscilloscope.

The sample is a 620 μm -thick intrinsic freestanding CVD diamond film onto which 250 nm-thick Al contacts were evaporated.

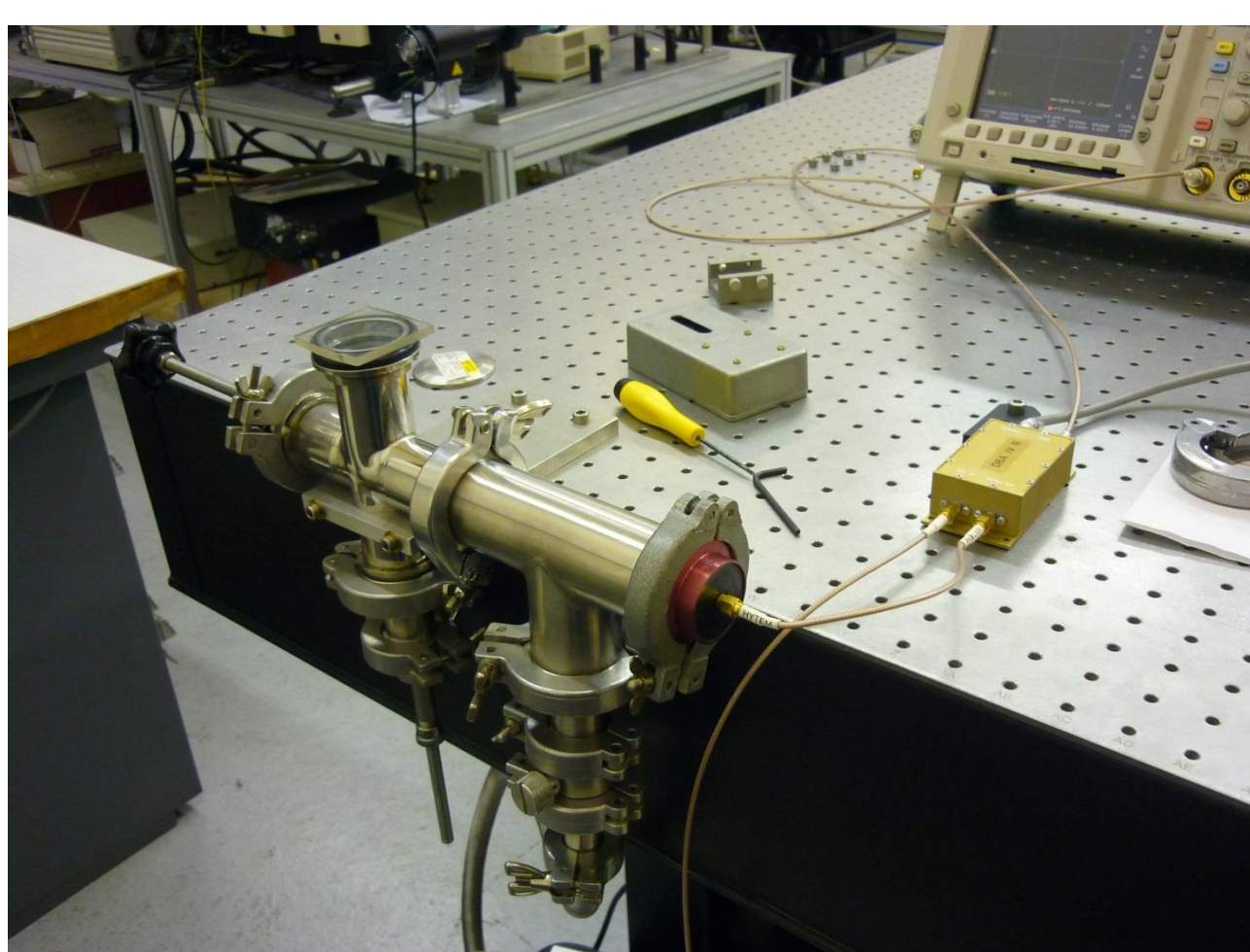

The experimental setup

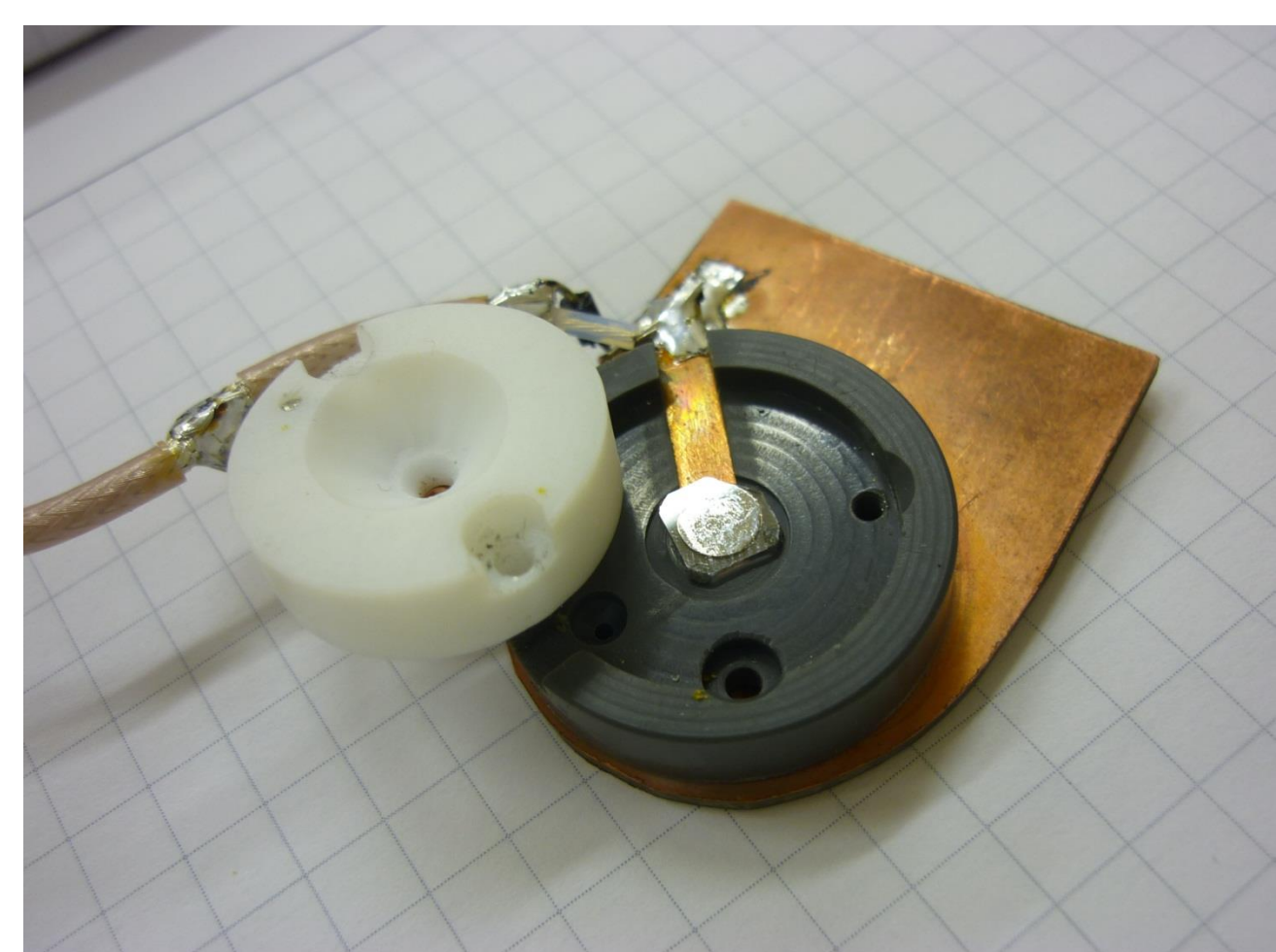

The sample in the sample holder

The measured signal is a peak which full width at half maximum is the time-of-flight. The hole mobility μ_h and electron mobility μ_e are extracted from the measured time of flight t_h and t_e with
$$\mu_{e/h} = \frac{d}{E \cdot t_{e/h}}$$
 where E is the applied electric field and d the diamond thickness.

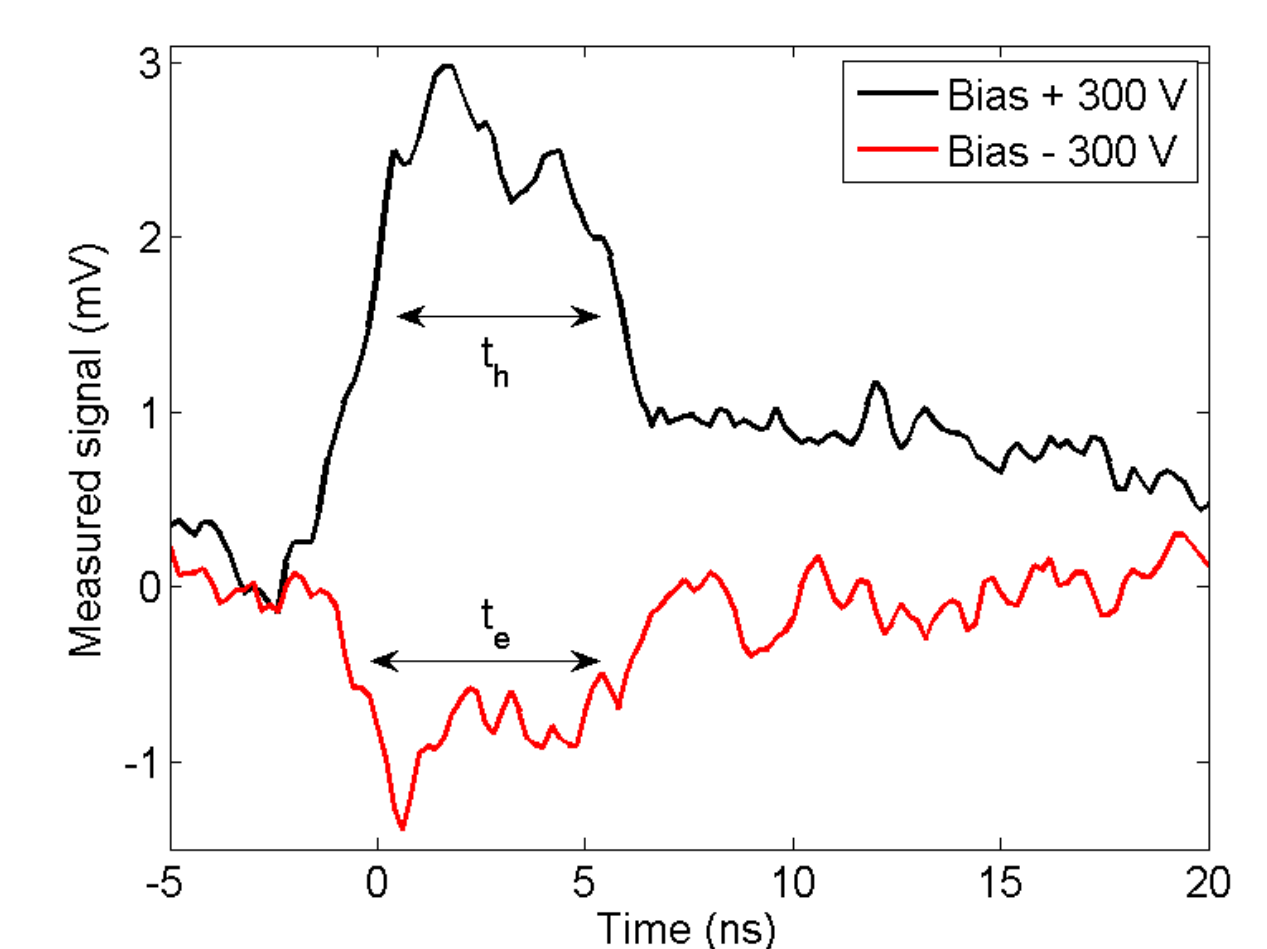
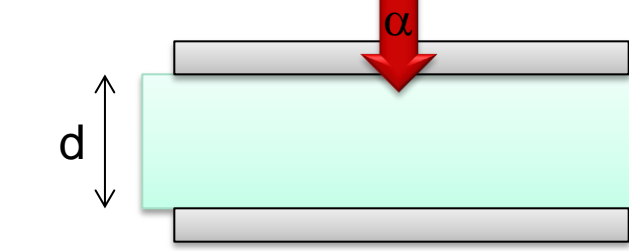
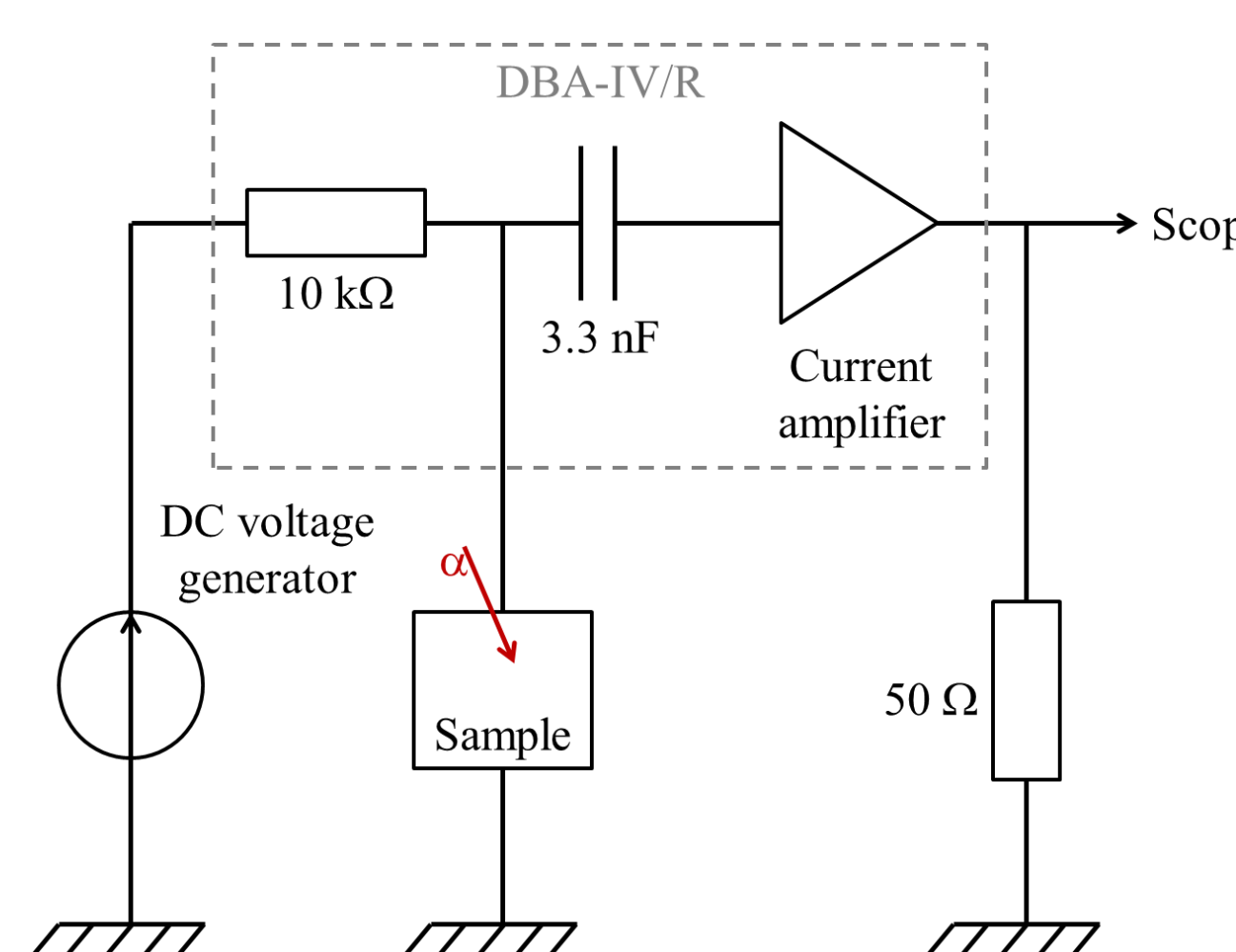

Measured signal and time-of-flight extraction

Results @ 300 V:

- Hole mobility of 2200 m^2/Vs
- Electron mobility of 2200 m^2/Vs

Conclusion

Time-of-Flight experiments have been performed. The experimental setup was studied by means of simulations.

The sample holder and the sample geometry have been studied. The effect of a particles in diamond and the charge transport have been modeled. Simulations show that the sample holder stops most of the particles while the electrode thickness is too low to have an influence on the energy deposition. The electrode geometry effect on the current measured have also been studied. This shows that a thin full plate electrode covering the sample is needed.

First measurements have shown a good electron and hole mobility in diamond. The experimental setup will be improved thanks to our simulation results to obtain more results.