



HAL
open science

Dossier: Was the Early Arabian ʿūd “fretted”?

Amine Beyhom

► To cite this version:

| Amine Beyhom. Dossier: Was the Early Arabian ʿūd “fretted”?. NEMO-Online, 2020. hal-03680896

HAL Id: hal-03680896

<https://cnrs.hal.science/hal-03680896>

Submitted on 29 May 2022

HAL is a multi-disciplinary open access archive for the deposit and dissemination of scientific research documents, whether they are published or not. The documents may come from teaching and research institutions in France or abroad, or from public or private research centers.

L'archive ouverte pluridisciplinaire **HAL**, est destinée au dépôt et à la diffusion de documents scientifiques de niveau recherche, publiés ou non, émanant des établissements d'enseignement et de recherche français ou étrangers, des laboratoires publics ou privés.

Dossier: Was the Early Arabian ‘ūd “fretted”?

Amine Beyhom*

“I have long felt that the practical music of many Asiatic peoples, ancient and modern, must have been and must be a totally different thing from the metaphysical or mathematical music of their philosophers, which as pure speculation must always have held itself apart from practice. We have erred in reasoning from the writings of theorists among these peoples to the nature of their art itself. [...] therefore, we should not say: the music of the Chinese, of the Indians [Hindus], of the Arabs, of the Persians etc., but: the musical system (or enigma) of the Chinese, the Indian, Arab, Persian philosophers, of Master Chrysanthos, etc. – Maybe it was no different for Ancient Greek music...”

[Raphael Georg Kiesewetter, *Über die Musik der neueren Griechen*]¹

“In the best cases, the theory [of music] inspires or enlivenes the [musical] practice, [...]. On the contrary, in the worst cases, theory comes to the aid of ideology to impose one [particular] system and erase subtle nuances”

[Jean During, “Introduction au Volume 71 1/2 de la Revue de Musicologie”]²

* Amine Beyhom is currently the editor in chief of NEMO-Online and director of the CERMAA (Centre de Recherches sur les Musiques Arabes et Apparentées), a research centre affiliated to the FOREDOFICO foundation in Lebanon.

¹ [Kiesewetter, 1858, p. 32]: partly translated and quoted in [Gilman, 1892, p. 57].

² [During, 1985, p. 7]. My heartfelt thanks to Jean During and Richard Dumbrell who reviewed this dossier and proposed numerous improvements.

³ [Adamson, 2011].

⁴ [Beyhom, 2016], more specifically the section on “Musicological Orientalism” p. 158-163.

“Al-Kindi oversaw one of the two main groups of translators in the ninth century (the other group was led by Hunayn ibn Ishaq). The ‘Kindi circle’ [...] translated numerous works of philosophy and science from Greek into Arabic. [...] Al-Kindi seems to have been a mediator between the patrons of these translators and the scholars who actually did the translating, many of whom were Syrian Christians or of Syrian extraction. His own writings might be thought of as a sustained public relations campaign intended to display and advertise the value of Greek thought for a contemporary ninth-century Muslim audience”

[Peter Adamson, “Al-Kindi”]³

INTRODUCTION

This dossier is a complement to the dossier on Hellenistic Orientalism published in 2016 in NEMO-Online⁴, in which I explained the main process of Orientalism in musicology and how it was based on Music theories beginning with Greek Neo-Pythagorean theories and ending with the so-called “Resonance” theory.

I also explained the need for most Orientalists to confine Early Arabian theories of the scale to the Pythagorean tonal model based on the division of the (Just) fourth in two whole-tones and one *leimma*. This division – that I name “ditonic” to differentiate it from other “diatonic” divisions of the tetrachord⁵ (see Fig. 3:118)⁶ – translates in the equal-tempered 2 whole-tones and one half-tone commonly used today. Apart from the use of biased, unfit for the analysis of Arabian music, theories and notation(s) as explained earlier⁷, and besides the fact that the Pythagorean theory – and other theories – of the scale fail at explaining the formation of the heptatonic

⁵ I use the terms “ditonic” and “ditonism” to differentiate the western exclusive concept of “diatonism” (or “tense diatonic” which corresponds to the Pythagorean two whole-tones + *leimma* division of the tetrachord – or to the equal-tempered two tones + one half-tone division) from generalized diatonism (or “zalzalism”), examples of which are provided in Fig. 3:118. (See also [Beyhom, 2016, Chapter 1] for a discussion of these concepts.)

⁶ The second number for the figure is the page number.

⁷ See aforementioned [Beyhom, 2016], and [Beyhom, 2018].

scale,⁸ Orientalist musicologists – beginning with Henry George Farmer and (not) ending with Eckhard Neubauer – promoted with great diligence the hypothesis of the fretting of the Early Arabian *‘ūd*, to the point that most musicological publications dealing today with Early Arabian music consider this “fretting” as an established fact.

Thus, in the *Encyclopedia of Islam*:

“Unlike the mediaeval lute, the modern lute is not fretted”,⁹

or further widened such as in Poché’s assertion in the *New Grove*:

“The neck [of the *‘ūd*] rarely has frets (*dasāīn*), but some are found on the Tunisian *‘ūd* of Khumayyis Tamān”,¹⁰

which is all that Christian Poché had to say on the matter,¹¹ while we can read in the same dictionary:

“The *‘ūd* still **survives** over all the Arab world, where it is used as a solo instrument and for accompanying song,¹² though it no longer has frets”.¹³

While this myth has already been invalidated elsewhere¹⁴ and is further invalidated here, very few contemporary researchers have put in doubt this common-place belief. To understand fully the reasons of the persistence of this fabrication against all indications of its invalidity, there needs only to remember that the music of the Early Arabs, in the eyes of Occidental musicologists, may explain the European music of the Middle Ages and its (later)

crystallization in the ditonic paradigm. Thus the Arabs would have – according to Orientalist musicologists – merely copied their theory from their predecessors, and their music would have further “regressed” being influenced by Persian (or other) music(s)¹⁵, *i.e.* musics supposedly outside the realm of restricted Hellenism. In the meantime, European (musical) culture retrieved its legitimate Greek legacy in its “purest” (ditonic) form, from which we can conclude that Europe and the Occident became effectively the only “legitimate heir” of Greek culture and civilization.

In parallel to this demonstration – or “fairy tale” – and as I show further, all indications in the Early Arabian treatises on praxis¹⁶ at that time are deemed insignificant or simply avoided – as with Neubauer for the latter process –, the role of ditonism is amplified and Zalzalian¹⁷ praxis minimized while archeological evidence is ignored for the sake of “continuity” and, when the evidence becomes too insistent, Arabian music becomes promoted as formulaic music with the scale playing a secondary role in its structure.

As with the “ditonism of the origins” of Byzantine chant – which ended up being a major fabrication of Western Byzantinologists¹⁸ – but for opposite purposes¹⁹, the alleged fretting of the *‘ūd* served as the main vector of the historical forgery of music history, mostly in the 19th and – mainly the first half

⁸ [Beyhom, 2016] and [Beyhom, 2003; 2004; 2010a; Beyhom, 2017].

⁹ [Chabrier et al., 2000], entry “*‘ūd*” (to which Farmer contributed originally).

¹⁰ [Poché, 2001, p. 27], entry “*‘ūd*”: as explained in [Beyhom, 2016], all Tunisian colleagues and musicians that I could consult on the matter confirm that they never saw – or heard of – “frets” on the *‘ūd* of Khumayyis Tamān.

¹¹ I suspect that Poché deliberately avoided a subject he knew was very controversial, precisely because of Farmer’s (posthumous, enduring) influence on the musicology of Arabian music.

¹² This is a very strange statement which restricts greatly the use of the *‘ūd* today as it is included in both large orchestras and small formations (sometimes few lutes playing together) in the Arab world – as well as in Europe – and frequently today in jazz ensembles (for fusion music).

¹³ [Wachsmann et al., 2007]: entry “Lute”. (Bold type mine.)

¹⁴ See [Beyhom, 2010b, v. 1, p. 324–363; Beyhom and Makhoulouf, 2009].

¹⁵ See for instance [Parisot, 1898, p. 10].

¹⁶ With regard to the scale and intervals used by performers.

¹⁷ “Zalzalian”: non-tempered music, not based on semi-tonal scales, and mainly relating to *maqām* music. The terms *Zalzalian* and *zalzalism* are used after Maṣūūr Zalzal a-ḡ-Ḍārib, an 8th-9th-centuries *‘ūd* player who was (supposedly) the first to introduce the fingerings of the *mujannab*(s) – that is the so-called “neutral” seconds and thirds – on the fingerboard of the *‘ūd*. It refers more generally to intervals (or musical systems which use them) using subdivisions other than the semi- (or “half-”) tone, noticeably all the varieties of *mujannab* seconds spreading from the (exact or Pythagorean) half-tone to the disjunctive (Pythagorean, or whole) tone. The same applies to intermediate intervals between the (exact or Pythagorean) tone and the one-and-half-tone interval (either equal-tempered or Pythagorean “augmented” second), etc.

¹⁸ See the “Appendix On the Origins and alleged ‘Diatonism’ of Byzantine Chant” in [Beyhom, 2015, p. 429–478], and Chapter 4 in [Beyhom, 2016].

¹⁹ Excluding *maqām* music from the evolutionary scheme, and including Byzantine chant in the European identity.

of the – 20th centuries, the sole purpose of which was the establishment of an evolutionary process of music²⁰ culminating with the Western Classical music of the common-practice period²¹.

“Why?”, could – still not convinced – benevolent musicologists ask, “what has the West to gain in defending the Pythagorean or ‘ditonic’ thesis”, “why do they wish to retain their simplistic scale whenever this affects their music – and its perception – rather negatively?”, would they sustain?²²

As explained above, the answer is simple: as the Ancient Greek legacy came to Europe mainly – at least in the first centuries of the Islamic civilization – from Arabian sources, Arabian music of the Early Islamic times (7th-9th centuries) was considered by European musicologists in the 18th and the (first half of the) 19th centuries to be the missing link between Ancient Greek music and the European music in the (European) Middle Ages²³. As European music was allegedly a relic of the Early European music, it could only be ditonic in its essence, as with European music in the common-practice period.

Furthermore, prominent researchers on Arabian music such as Henry George Farmer promoted the existence of an embryonic form of polyphony – on a ditonic basis, evidently – in Early Arabian music which confirmed – in their opinion – the role of the latter music as the missing link with Ancient Greek music.²⁴

Let us remember that the early theory of Western music was heavily influenced by Boethius’ (see Fig. 1) *De institutione musica* – which was rediscovered in

the Carolingian Era (9th century – See Fig. 2.) and abundantly copied since²⁵ – purely on Pythagorean ground.

While trying to prove that European music is the heir of (the music of) Ancient Greece, musicologists were compelled to consider the missing link, which is Arabian writings on music (theory). Therefore, Early Arabian music must have been ditonic (as Ancient Greek music was mainly supposed to be), and transmitted to the West on this ground.



Fig. 1 Boethius’ tomb in San Pietro in Ciel d’Oro, Pavia.²⁶

As I already wrote in “The ‘fretting’ of the Arabian *‘ūd* – or Sequencing Musicological Orientalism”²⁷, as long as the main threat comes from the theories of the scale, and while early Arabian writings about music theory²⁸ base the scale theory on the *‘ūd*, this instrument *had* to be fretted because if it were not, this would leave open perspectives for all non-tempered musics to be performed on it, which would directly contradict the evolutionary thesis based on the ditonic dogma.

²⁰ This procedure is explained in detail in [Beyhom, 2016], more particularly in the “Preliminary Synthesis” [Beyhom, 2016, p. 175–176], the reading of which is recommended for a better understanding of how the Orientalist scheme led to the necessity of the “fretting” of the *‘ūd*.

²¹ The terminology is borrowed from Ruth Solie’s “Melody and the Historiography of Music” [1982, p. 297].

²² These points were effectively questioned by Jean During in a private and virtual discussion about this dossier on September 19th 2020.

²³ This time-period corresponded to the Golden Era of Islamic civilization.

²⁴ Byzantine Chant could have been a parallel link to Ancient Greece, but its “Oriental” nature deeply disturbed European specialists who followed a similar scheme, however not to exclude but to integrate Early Byzantine Chant in (Western) Europe.

²⁵ See [Boethius, 2004, p. 1]. See also [Wikipedia Contributors, 2020] and the preface of the more academic [Bower, 1989, p. xiii] (written by Palisca), notably: “Beginning around the ninth century, *De institutione musica* became established as the foundation of Western music theory, and throughout the Middle Ages Boethius remained the authority most revered for music-theoretic matters.”

²⁶ Retrieved from [Dall’Orto, 2009]: Boethius was a “martyr” of the Catholic cause.

²⁷ [Beyhom, 2016, p. 159–162].

²⁸ And until at least the 14th-15th centuries.



Fig. 2 The Carolingian Empire at its peak.²⁹

The procedure followed by Orientalist musicologists was therefore to change the Zalzalian aspect of theories using this instrument, namely:

- Firstly, and from one, single (theoretical) description by the first major Arabian theoretician, Ya‘qūb Ibn Ishāq al-Kindī (“The Philosopher of the Arabs”), and by neglecting all indications about praxis given by the author, the “Early Arabian ‘ūd” (of the “Middle Ages”) is proclaimed “fretted” ditonically, thus:
 - Early Arabian music was ditonic and tempered.
- Secondly, from this first example, it is taken that *all* Arabian ‘ūd(s) were “fretted”, not only in theory but also in praxis, not only at the time of Kindī, but from the very beginnings of this music until the post-Ṣafīyy-a-d-Dīn period (post-13th-Century), “forgetting” that:
 - Kindī was the first Pythagorean philosopher influenced by Plato who took over Ancient Greek theories for the purpose of theorizing the yet un-theorized Arabian music of his time, and that it was tempting to materialize the Pythagorean division of the octave directly on the neck of the ‘ūd – the primary instrument of Arabian music at that time and up to the present.
 - Kindī’s epistle *Risāla fī-l-Luḥūn wa-n-Nagham* – in which the description of the “frets” is given – was dedicated the son of Caliph al-Mu‘taṣim (833-842), Aḥmad ibn al-Mu‘taṣim – an amateur musician – and was meant as an informative

²⁹ Source: https://3.bp.blogspot.com/-tn4kVZWdXos/Ulfqyedi_wI/AAAAAAAAInY/W29gY0Powto/w1200-h630-p-k-no-nu/Carolingian-Dynasty.gif.

³⁰ As explained in [Beyhom, 2010b, v. 1, p. 183-276 (Chapter II)].

³¹ I use the term “tie-fret” for frets made of gut or other material which are wound around the neck of the ‘ūd and knotted on the back side. “Ligature” is a more reliable translation of the term

treatise as well as a teaching method for the instrument.

- In the only instance where Kindī describes the ‘ūd playing techniques and strings stopping, his explanations are at some point inconsistent and incompatible with an effective fretting of the instrument.
- Kindī further described notes “used by singers” from which it can be deduced that the effective division of the scale was the seventeen (unequal, Zalzalian) intervals division explicitly given by his famous successors Fārābī (the “Second Master” – by reference to the “First Master”, Aristotelēs) and Sīnā.³⁰
- All subsequent authors who mention “ligatures” on the neck of the ‘ūd explain that the string must be stopped at exactly the position of the “tie-fret”³¹, (which is incoherent with the “ties” having the function of effective frets – as shown in Appendix B), and that most of them mention the possibility of stopping the strings *between* the ligatures, or to use hand shifts (towards the bridge) for higher notes, to positions where there are *no ligatures* (or marks).
- The second proven description of an effective “fretting” of the ‘ūd³² is found in Muḥammad ibn al-Ḥasan ibn a-ṭ-Ṭaḥḥān’s treatise. He was a Fatimid musician, singer and teacher who explained that a particular type of fretting was used for beginners.
- All subsequent authors mentioning ligatures (*dasātīn*) on the neck of the ‘ūd either do not mention any material for those, or say that they are marks³³ on the surface of the neck indicating stopping positions of the strings.

All these facts are ignored – or brushed aside when mentioned – by Orientalists and hence, despite very few contradicting views, the myth of the fretting of the early ‘ūd promoted by a series of more

dastān (pl. *dasātīn*) used in the Arabic literature about music theory which avoids the recourse to the term “fret” – which is misleading. The *dasātīn* (from the Persian “*dast*”, “hand”) were generally, as I show further, marks on the neck of the instrument.

³² Probably inspired by Kindī’s description.

³³ Or possibly threads as explained further.

or less renowned authors including Lachmann, Farmer, Manik, and finally Neubauer, is still taught in *maqām* musicology³⁴ against all factual data³⁵.

The main aim of this dossier is to assemble all possible data about this alleged fretting of the instrument, in order to draw worthwhile conclusions, set on a firm ground.

PREFATORY REMARKS

This dossier is composed of three main parts and accompanied by two videos:

- Part I features explanations about (al-) Kindī’s³⁶ division(s) of the fingerboard of the *‘ūd*. It then explains the partitioning of the tetrachord in seven divisions (and of the tone in three divisions) which ends with the partitioning of the octave in 17 unequal intervals (in this case with Zalzalian intervals, or generalized diatonism³⁷). This division is present in Arabian specialized literature from the very beginnings,³⁸ and is rooted in music practice since the Forerunners³⁹. It was the main representation of the scale in the Golden Age of the Arabian Civilization from (al-) Fārābī (9th Century) to (al-) Urmawī (13th Century).
- Part II is a reflection about the theoretical use of the Arabian *‘ūd*, and how this instrument was

erroneously fretted by (some) Western musicologists – including Eckhard Neubauer’s attempts at reviving the thesis of the fretting of the (early) Arabian *‘ūd* in his article “*Der Bau der Laute und ihre Besaitung nach arabischen, persischen und türkischen Quellen des 9. bis 15. Jahrhunderts*”⁴⁰ – then by autochthonous re-orientalists. It exemplifies the – willful or unconscious – blindness of some (modern and contemporary) Orientalists when it comes to the ditonic (or “tense diatonic”) dogma of Western musicology.

- The third part consists in a series of four appendices:
 - Appendix A (“The *‘ūd*, its components and its proportions”) is a reminder about the proportions of the *‘ūd* and its components in the early period – and nowadays for its proportions.
 - Appendix B (“Organological clarifications”) lists the organological problems raised by the fretting of the *‘ūd*.
 - Appendix C reviews the contents of *The Risāla fī l-Mūsīqā* by (al-) Munajjim (856-912) and shows that the Pythagorean division attributed to this author cannot be sustained.

³⁴ I recently had to warn a colleague from publishing in an article that the Early *‘ūd* was fretted, despite his protests that this “fretting” was “an established fact”.

³⁵ In fact, a converging array of evidence contradicting the thesis of the “fretted” *‘ūd*.

³⁶ The “Philosopher of the Arabs” and the first author whose works on Arabian music theory are (partly) extant.

³⁷ The term “generalized diatonism” is used to oppose the general concept of diatonism in Ancient Greek theories to the particular tense (Western) diatonism. (See Fig. 3:118.)

³⁸ Although not explicitly in the case of Kindī.

³⁹ The term comes from my proposed (in [Beyhom, 2010b]) division of the history of *maqām* music (theory): 1. *The Forerunners*: mostly (al-) Kindī (9th century) and (al-) Munajjim (9th and beginning of the 10th centuries); 2. *The Golden Age*: from (al-) Fārābī (Latinized “Alfarabius” – 10th century) to ibn Zayla (d. 1048), not forgetting the mentor of the latter, ibn Sīnā – or Avicenna – (980-1037); 3. *The Systematists*: beginning with (al-) Urmawī (13th century), with followers such as (al-) Lādhiqī or (al-) Marāghī; 4. *The Intermediate Period*: with writings such as the Anonymous *A-sh-Shajara dhāt al-Akmām* [published as [Anonyme, 1983]], or from [Ṣaydāwī (a-ṣ-), XV^e siècle] (translated to French in [Ṣaydāwī (a-ṣ-) and Antar, 2001]) or the pseudo Ṣafadī published as [Ṣafadī (a-

ṣ-), 1991]; 5. *The Moderns*: beginning with Mashāqa (19th century) and his mentor Farīd-a-d-Dīn al-‘Attār and ending with the 1960s (not forgetting [Khulāī (al-), 1904]); 6. *The Contemporary Period*: roughly since the 1970s and the predominance of the Conservatoires in the teaching of Arabian music. (Note that periods 3 and 4 may overlap.) As for Arabian music *per se*, [Jargy and Chottin, 2001, p. 527] identifies (for example – Guettat has another division still, as seen in Chapter V of [Beyhom, 2016]) five time periods (which correspond only partly to the aforementioned six, and disregard the post-*Congrès du Caire* period), namely: “1) *Bedouin period*, from the *Jāhiliyya* [“the time of ignorance”] till Early Islam (death of ‘Alī, 661); 2) *Assimilation period*, from the Umayyad dynasty till the First Abbasid cycle (circa 830); 3) *Period of Fulfilment and Dispersion*, with the second Abbasid cycle and the establishment of the Umayyad in Spain; 4) *Period of Decline*, from the taking of Granada [note here that Jargy does not term this as ‘the Fall’ of Granada] (1492) till the end of the 18th century; 5) *Renaissance*: from the *Nahḍa* [hence the term “Renaissance”] in the 19th century, beginning with the expedition of Bonaparte in Egypt end of the 18th century, until the [C]ongrès du Caire (1932)”.

⁴⁰ [Neubauer, 1993], which is, as a matter of fact, a dossier of nearly 80 pages.

Tetrachordal divisions (Ancient Greek theories) - A -									
Theoretician	Archytas			Eratosthenos			Didymus		
Type	enharmonic	chromatic	diatonic	enharmonic	chromatic	diatonic	enharmonic	chromatic	diatonic
1 st ratio	4/5	27/32	8/9	15/19	5/6	8/9	4/5	5/6	8/9
in cents	386	294	204	409	316	204	386	316	204
2 nd ratio	35/36	224/243	7/8	38/39	18/19	8/9	30/31	24/25	9/10
in cents	49	141	231	45	94	204	57	71	182
3 rd ratio	27/28	27/28	27/28	39/40	19/20	243/256	31/32	15/16	15/16
in cents	63	63	63	44	89	90	55	112	112
sum	498	498	498	498	498	498	498	498	498
Equivalences	Fārābi (4/5, 27/28, 35/36), Sīnā (35/36, 4/5, 27/28)	missing	Fārābi, Sīnā (7/8, 8/9, 27/28)	missing	Fārābi (last 2 inverted), Sīnā (inverted)	Fārābi and Sīnā	Fārābi and Sīnā (4/5, 31/32, 30/31)	Fārābi (last 2 inverted), Sīnā	Fārābi, Sīnā (9/10, 8/9, 15/16)

Tetrachordal divisions (Ancient Greek theories) - B -									
Theoretician	Ptolemaeus								
Type	enharmonic	soft chromatic	tense chromatic	soft diatonic	middle or tonic diatonic	ditonic diatonic	tense or syntonic diatonic	equal diatonic	enharmonic 2 nd form
1 st ratio	4/5	5/6	6/7	7/8	8/9	8/9	9/10	9/10	4/5
in cents	386	316	267	231	204	204	182	182	386
2 nd ratio	23/24	14/15	11/12	9/10	7/8	8/9	8/9	10/11	21/22
in cents	74	119	151	182	231	204	204	165	81
3 rd ratio	45/46	27/28	21/22	20/21	27/28	243/256	15/16	11/12	55/56
in cents	38	63	81	84	63	90	112	151	31
sum	498	498	498	498	498	498	498	498	498
Equivalences	Fārābi	Fārābi and Sīnā	Fārābi and Sīnā	Fārābi and Sīnā	Fārābi (7/8, 8/9, 27/28), Sīnā	Fārābi and Sīnā	Fārābi (first 2 inverted), Sīnā	Fārābi	(Erlanger)

Fig. 3 Ancient Greek tetrachords with equivalents in the writings of (al-) Fārābi (9th-10th centuries – see [Wright, 2001a]) and (ibn) Sīnā (10th-11th centuries – see [Wright, 2001b]), the two major Arabian music theoreticians of the Golden Age. Arabian tetrachords are taken from [Fārābi (al-), 1930; Fārābi (al-) et al., 1935; Yūsuf, 1956; 1998, أبو نصر محمد بن محمد بن ترخان الفارابي, 1967 الفارابي]; Greek tetrachords from [Mathiesen, 1999]; the enharmonic tetrachord in its 2nd form in the lower table (Ptolemaeos – last column to the right) is taken from the Appendix of [Erlanger, 1930]. First published (in French) in [Beyhom, 2010b].

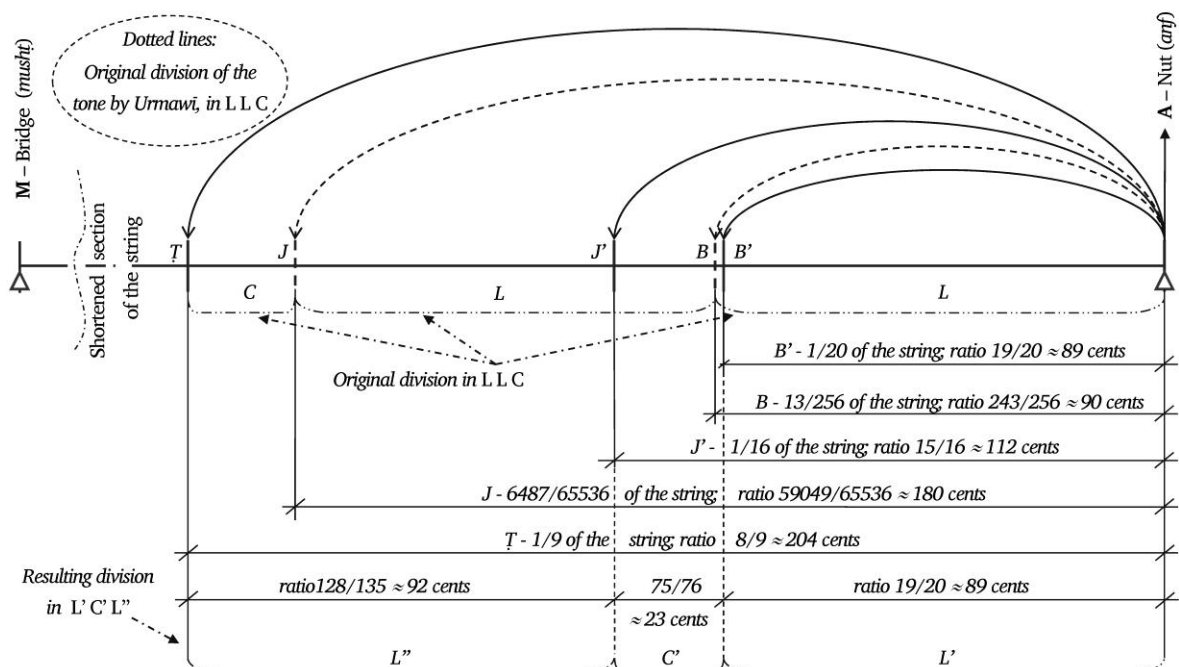

Fig. 4 Urmawī's two divisions of the tone (L L C and alternative L' C' L'') – from right to left, top to bottom, in the figure) in the *Kitāb al-Adwār* [Urmawī (d. 1294), 2001] and corresponding ratios and intervals in cents.

- Appendix D (“Original texts”) is a collection of the original texts the translation of which is proposed in the main text.⁴¹
- The two complementary videos were published with the article on the ‘ūd – in French – by the author with Hamdi Makhoulouf⁴², with subtitles by Beyhom:
 - The first video is entitled *Fretting of the ‘ūd according to (al-) Kindī*,⁴³ and shows the stringing and positioning of the frets as explained by (al-) Kindī, for both a “Harmonic” and a Pythagorean tunings.
 - The second video is entitled *Fretting of the ‘ūd according to Ibn a-ṭ-Ṭahḥān*⁴⁴ and shows the same procedure but with one set of strings described by (ibn a-ṭ-) Ṭahḥān.

While most of the material proposed to the reader is based on my first book (in French) about Arabian music theory and praxis to the 13th century and on the article published with Hamdi Makhoulouf⁴⁵, new data is provided in this dossier which complements my earlier writings on the subject.⁴⁶

* * *

⁴¹ This is for clarity of the main text, while philological differences impose the reproduction of the original texts for verification purposes.

⁴² [Beyhom and Makhoulouf, 2009].

⁴³ Available at https://youtu.be/d7TTlnH_pKM.

⁴⁴ Available at <https://youtu.be/demT-hpcX1s>.

⁴⁵ [Beyhom, 2010b] and aforementioned [Beyhom and Makhoulouf, 2009]. Most of the translated text from [Beyhom, 2010b] is an adapted, emended and shortened version the purpose of which is to expound the results of the research undergone, while more detailed explanations (and translations) are proposed for the alleged fretting of the ‘ūd. Likewise, other (Pythagorean) divisions (such as by Ikhwān a-ṣ-Ṣafā’ and al-Khawārizmī) are not incorporated in the dossier, as Kindī’s and Munajjim’s propositions (expounded further) are a significant enough sample of the theoretical speculations of the “Forerunners”.

⁴⁶ Note that some of the material included in [Beyhom, 2016], mostly from the last section of Chapter I entitled “Greek theories in

A CONCLUSION AS FOREWORD⁴⁷

Between the 7th and the 9th centuries, the expansion of Islam⁴⁸ resulted in an Arabic-speaking empire extending from Persia to Spain, including North Africa and parts of Central Asia. The major confrontation of this Arabian-based empire was, at that time, not with the West but with the Byzantine Empire which predominated on its North-Western front. The music of the kingdoms of the Arabian Peninsula could compete with difficulty with the music of some of the conquered peoples, as with the music of Bilād a-sh-Shām⁴⁹ being part of the former Roman Empire,⁵⁰ and with the music of Persia. Claiming a purity of the Arabian (“Bedouin”) musical art would be, with such facts at hand, an aberration.

The process of acculturation of the Bedouin Arabs, which became the rulers of an empire extending far beyond their original habitat, is unfortunately not documented for their music.⁵¹ All the writings on music of the period, anterior to (al-) Kindī’s, have been lost. Later chroniclers such as Mas‘ūdī and (ibn) Salma⁵² have tried to retrace the evolution of the Arabian society towards a Pan-Islamic society, starting with the small kingdoms of the Arabian Peninsula and ending with the Abbasid caliphate, and recreated thus the illusion of a continuity of the original “purity”, an ongoing and exclusive filiation of the Arabian Empire.

It is, however, self-evident that Arabian music in the 9th century could only be the hybrid result of the Islamic melting pot, with influences as diverse as Persian, Byzantine, Mediterranean music and music from Central Asia (Fig. 5).⁵³

Arabian writings”, may be of use for the reader and is cited where deemed necessary.

⁴⁷ This section was originally the “Synthesis” of the first chapter of [Beyhom, 2010b] regarding the theories of the Forerunners, which seemed to me best suited as a foreword to this dossier.

⁴⁸ Both religion and civilization.

⁴⁹ Syria and Lebanon and, by extension, Jordan and Palestine.

⁵⁰ Then of the Byzantine Empire (or the Eastern Roman Empire).

⁵¹ The process of acculturation was not one-sided: Arabian culture (poetry, language, rhythms, music) influenced also the conquered peoples, whatever influence the culture of the latter had on the Arabian rulers.

⁵² See [Mas‘ūdī, 1987 ; Salma (a-n-Naḥawī al-Lughawī), 1984], and [Khalidi and Mas‘ūdī, 1974] for the importance of Mas‘ūdī as a historian.

⁵³ Two short (and available) references on, respectively, the conquest of Egypt and the conquest of Central Asia are [Butler, 1902] and [Gibb, 1970].

More than two centuries after the beginning of the expansion of Islam⁵⁴, Arabian scholars and philosophers had to get on with the heavy task of characterizing this music and to establish a unified presentation of it intended, above all, for the Abbasid Caliphs and for other, lesser, contemporary potentates.

This procedure took place concurrently with the assimilation of the vast scientific and cultural corpus of Ancient Greece from which these scholars quickly tried to establish an “Arabian”⁵⁵ music theory with pretense to universality. (Examples of the appropriation of Ancient Greek music theories by Arabian theoreticians are proposed in Fig. 3:118 and Fig. 4:118.)

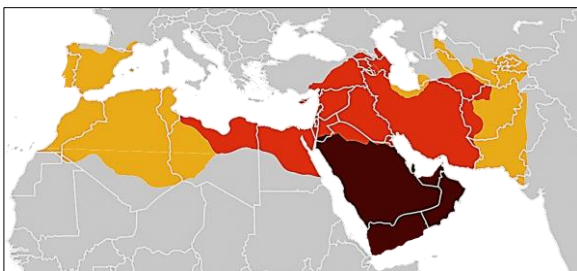

Fig. 5 Expansion of the Caliphate until 750: ■ → Expansion under the Prophet Muḥammad, 622-632; ■ → Expansion during the Patriarchal Caliphate (Rāshidūn), 632-661; ■ → Expansion during the Umayyad Caliphate, 661-750. (From [DieBuche, 2010] based on [Anon. “Age_of_Caliphs.png (Image PNG, 684 × 347 pixels)”]: conquered territories included all or part of the Levant, Mesopotamia, Persia, North Africa, Iberia, Gaul, Transoxania, Sindh and Caucasus – see also [Wikipedia Contributors, 2017b].)

It is important to remember that the first “theoreticians” of the Arabian Empire⁵⁶ were neither simple musicians trying to codify and transmit their art, nor “musicologists” in the contemporary sense of the word – meaning by that Music historians or analysts. Music “science” was therefore originally confined, through the influence of Pythagoreanism and neo-Pythagoreanism, to the mathematical and cosmogonic domains, as the near totality of Early (and extant) works shows. Adding to this fact that the Arabian concept of plagiarism was

(and still is today) very different from the modern Western concept,⁵⁷ and that this procedure was concurrently transposed to translations from Greek Masters, it becomes less surprising that many of the most early writings on Arabian music are much alike, and use mainly Pythagorean ditonism as the basis of their theoretical explanations.

This theoretical handling, although already breached in Kindī’s epistle (“*Risāla*”) *fi-l-Luḥūn wa-n-Naḡham*, changes radically with (al-) Fārābī⁵⁸ in his *Great Book of Music* in which we find, finally(!), the expression of a powerful (and critical) mind exploring music and music theory of his time. This theoretician’s approach is respectful of “The Masters of the Art” – *Ahl a-ṣ-Ṣinā’a* to which he refers when practical details are needed – and of practical music, which ended up in him being the first to explicitly include Zalzalism in his theoretical descriptions of the Arabian scale.

* * *

It is worthwhile, even at this early stage in this dossier, wondering about the social and intellectual contexts which resulted in the exclusion – for many decades – of an already existing, even characteristic phenomenon as Zalzalism (or non-temperalism), from the theorization of Arabian (*maqām*) music; this context is explicitly scrutinized in the following pages.

Let us note that the already signaled (al-) Kindī⁵⁹ – surnamed the “Philosopher of the Arabs” – seems to have well earned his surname in music theory⁶⁰ as he was the first to include the ditonic division of the (Neo) Pythagoreans in his theoretical reasoning.

We should however also note from the outset that the principal aim of this philosopher was to incorporate Greek “science” in Arabian nascent philosophy – to “advertise” it as Adamson writes in the epigraph. In such a context, the concordance between Greek theories and Arabian (or even “Greek”) musical praxis becomes of

for manuscripts in the libraries of Egypt, Morocco, Russia, Tunisia and others seem to be also available (as noted in “Seminararbeit von Silja Geisler-Baum, Sommersemester 2004, Betreuung: Prof. Dr. Ursula Georgy”).

⁶⁰ Unlike Aristoxenos – who, as reminded in [Beyhom, 2016] and even though he was also a philosopher, approached nevertheless music from a practical point of view – Pythagoreans and Neo-Pythagoreans had a strictly philosophical, if not dogmatic approach to music.

⁵⁴ The civilization, here differentiated from the religion.

⁵⁵ I use “Arabian” for Arabian-Persian-Turkic – and later Ottoman – music.

⁵⁶ The fact that the Caliphate was an empire exonerates me from specifying whether the authors were Arabs, Persian or Turkic (or Armenian, Jew and other nationalities – or religions).

⁵⁷ See [Grunebaum, 1944].

⁵⁸ The “Second Master” (to Aristotle).

⁵⁹ For a comprehensive reviews of Arabian sources, see [Farmer, 1965; Shiloah, 1979] – a second volume of RISM by Shiloah, 2003,

secondary importance.⁶¹ Let us also note that Kindi was more of a translator than a “transmitter” of Ancient Greek tradition.⁶² He was however the first to describe the Arabian musical system through the division of the fingerboard of the ‘ūd, even if we do not know for certain if his use of the ditonic division of the fourth corresponds at all to praxis⁶³ at that time. The ditonic division, which is probably justified by Kindi’s pretense in his epistle *fi-l-Luḥūn wa-n-Nagham*⁶⁴ to a “simplicity” of music – as a “science” and inherited from Platonic interpretations – contradicts somewhat the description of the *genē* in his epistle *fi Khubr Šinā‘at a-t-Ta’lif* which includes, notably, an enharmonic *genos* with two quarter-tones.⁶⁵

Whenever the question of the adequacy of the simplistic ditonic division with the music of that time is clearly raised by Kindi’s description of praxis (singing – *ghinā’* – as opposed to “musical science”) in the *Risāla fi-l-Luḥūn wa-n-Nagham*, his interest in the “science” of music is undeniable, as testify the numerous epistles he devoted to the subject.

In a very Arabian-like approach about the transmission of knowledge,⁶⁶ several of Kindi’s successors – such

as Ikhwān a-ṣ-Ṣafā’ and (al-) Khawārizmī – adopted the Pythagorean premises of this philosopher, forgetting however about his mentions of praxis which stand far from intervallic mensuration and from arithmetical handlings. The latter – practical – approach, which would have probably been welcomed by the musicians of his time, was unfortunately an exception.

Mentions of practice are rare – if not inexistent – in the literature until the advent of Fārābī, and while the latter tried to reform music theory he had, however reluctantly, to contend with earlier writings whatever lacunae he may have found in them. Whenever Kindi avoided⁶⁷ introducing new ratios to describe the Zalzalīan intervals used in praxis, (al-) Fārābī and later (ibn) Sīnā and (al-) Urmawī⁶⁸, while keeping the ditonic norm imposed by their predecessor(s),⁶⁹ integrated new and old divisions based on string-length equal-divisions, or recalling non-ditonic ratios used by these predecessors.⁷⁰

More generally, the question that is raised concerns the adequacy of the theoretical systems which were described by Arabian theoreticians, with praxis.⁷¹

⁶¹ Plausibly, the same phenomenon took place in Western theory of music beginning with the so-called “Middle-Ages”.

⁶² Notably for ethos theory and numerical correspondences with the four elements, nature, etc. To “transmit” is here used in the sense of a living tradition which is handed down – modified and augmented but still traditional – to others (see [During, 1994]).

⁶³ Or to the extent of this practice.

⁶⁴ Reviewed further.

⁶⁵ Knowing that the translation of Ancient Greek sources was an ongoing process in the time of Kindi, it is very possible that his successive epistles on music – for which we do not have a precise chronology – were based on different translations from different, and more or less complete, Ancient Greek sources.

⁶⁶ See footnote no. 57:120 above.

⁶⁷ Maybe because of the lack of intellectual audacity, or capacity to conceive them: Arabian music “science” was still to be founded at his time and, while Kindi was a pioneer at introducing Ancient Greek theories to the Arabs, he would reluctantly “alter” them (or the part of it he had access to). In his *Risāla fi-l-Luḥūn wa-n-Nagham*, intended as a manual for the son of the Caliph (see further), Kindi had to resolve the obvious discrepancies between (Greek) theory and (Arabian) praxis, which he did by signaling approximate positions for Zalzalīan (Arabian) notes between the notes of the Canonical (ditonic, Pythagorean) division – as is explained further.

⁶⁸ Although Ṣafīyy-a-d-Dīn al-Urmawī used a refined Pythagorean adaptation of zalzalism in his *Early Book of Cycles* [Urmawī (d. 1294), 1984; 2001] (see explanations and comments in [Wright, 1969], [Beyhom, 2010a; Beyhom, 2018], and Fig. 4:118), he was

compelled to modify it by introducing explicit zalzalism in his second major (and comprehensive) work, the *Risāla a-sh-Sharafiyya* [Urmawī (d. 1294) and [Jurjāni (al-), 1938].

⁶⁹ This includes Ancient Greek theoreticians that Fārābī would reluctantly criticize, while preferring (see [Beyhom, 2016], p. 79, fn. 197) to ascribe their imperfections to the translators of their works (notably Kindi and his group of translators?).

⁷⁰ See for example Appendix 3 in [Beyhom, 2016] and Fig. 3:118 as well as Fig. 4:118.

⁷¹ This topic is seldom addressed for example by Sawa in his article [Sawa, 1981] or in his book [Sawa, 1989], although the author insists on the practical aspect of the music he researches, as in [Sawa, 1981, p. 85–86]: “Obviously, even for ethnomusicologists interested in modern musical practices and musical life, historical ethnomusicology can be a lively and extremely useful subject of research in at least two ways. First, it can clarify the reasons behind many modern concepts and practices. Second, ethnomusicologists with an intimate knowledge of modern practices can clarify ambiguities in the historical sources. Finally, for present-day native Middle Eastern musicians, the study of the past offers the necessary methods and terminology for the study of their own music. This is a much more suitable and fruitful procedure than borrowing irrelevant, if not damaging, concepts from 18th- and 19th-century European art music”. While I agree with the conclusion of Sawa, I could not help but note that the author’s descriptions of the Early Arabian theoretical systems are but a little too... theoretical, as he does not even address Kindi’s writings and neglects comparisons with praxis with (al-) Fārābī and others, a steady attitude with re-orientalizing musicologists of the *maqām* (as explained in Chapter V of [Beyhom, 2016]).

Other questions remain unanswered, concerning notably the relation of Arabian music praxis at the time – ascribed to the court of the Caliph and to the high society and characterized by the use of seven subdivisions within the tetrachord (just fourth) –⁷² with the music of the peoples of this vast empire.

Is it possible that Court music followed the same rules and system as with shepherds, artisans, farmers, city ruffians and prostitutes of both sexes scattered in such disparate regions as the Arabian Rab‘ al-Khālī, Post-Byzantine Syria, Egypt, Iraq, Central Asia and Persia, not to mention North-Africa and Spain?

Maybe not, and maybe yes, as popular musics today, in the Arab world, follow the same principles as with Art music,⁷³ while the main question can still not be answered definitely as sources on the subject are unavailable, or maybe never existed.⁷⁴

The second question which is (inevitably) raised concerns the adequacy of the Pythagorean ditonic model with Court music *per se*: does the Pythagorean substrate, which is contradicted by Zalzalian inclusions, coincide even loosely with the praxis of Art music at the time?

Here again the lack of sources compels us to delay the answer to this question.⁷⁵ What is today clear is that the 7-intervals per just fourth division, extended to the

17-intervals division of the octave (both in unequal intervals) is a constant feature of these theories, beginning with Kindī and extending to the late Systematists.

*
* *
*

PART I. FIRST THEORETICAL AND PRACTICAL DESCRIPTIONS

The theoretical treatment of the scale in the period of the Forerunners is characterized by the recourse to Pythagorean ditonism. It must be remembered that, during Kindī’s time, the large-scale translation of Ancient Greek texts was still in its infancy.⁷⁶ Arabian philosophers hurried to use these texts and adapt them to Arabian music, whatever differences with praxis.

The first theoretical procedure of which we are aware with Arabian theoreticians about the modeling of the melodic vertical space is the division of the strings on the neck of the ‘ūd,⁷⁷ mostly limited for each string to its first acoustical characteristic interval, the fourth.⁷⁸ While music was assimilated by these philosophers to a theoretical science,⁷⁹ and whenever the ‘ūd was the main (and very versatile) instrument for performance, it

⁷² This has been determined for Arabian music in [Beyhom, 2010b], beginning with the first Arabian Philosopher (and theoretician), (al-) Kindī, and is expounded in Part I of this dossier.

⁷³ Till the Modern period and excluding school syllabuses.

⁷⁴ Extant sources deal only with caliphal – or Art – music, with few exceptions (such as Fārābī’s and Kātīb’s descriptions of the *tunbūr Baḡhdādī* – see [Beyhom, 2010b, v. 1, p. 311, 320]) – which are not conclusive.

⁷⁵ Sources are scarce or unavailable for the period before Kindī, and the research on Arabian scale theory must begin with works dating two centuries after the advent of Islam (the religion) – in the Abbasid period – with Arabian theoreticians finally addressing Ancient Greek theories and some of them trying to adapt these theories to the musics practiced in the vast countries dominated by the Caliphs. The craze for these theories (which reminds of the Philhellenic trend in Europe in the 18th-19th centuries) has perhaps determined a *de facto* inclusion of Pythagorean ditonism in music practice at the court of the Caliphate in Baghdad and, by extension and impregnation, in other population segments and other regions of the Arabian empire. {Richard Dumbrell reminds here – personal communication – that ditonism seems to have been known since the middle of the first millennium BCE, as is shown in the tablet CBS 1766 dating from the Neo-Babylonian Period historically known as the Chaldean Empire (626 -539 BCE).}

⁷⁶ *Bayt al-Ḥikma* (“The House of Wisdom”), in which this large-scale operation started, was founded by Caliph al-Ma’mūn in 830, when

Kindī died in 866. The latter wrote numerous epistles on music that we are unable to date precisely. Note also that, contrarily to previous assimilation of Arabian music theory in this period, which begins with (al-) Munajjim’s extant epistle on the subject, I begin in my book (and in this dossier) this review with Kindī. This is justified by the simple reason that Munajjim was born in 856 (and died in 912 according to Farmer). (Note that Munajjim’s epistle includes a few references to Aṣḡahānī – a music chronicler who gives no indications about the composition of the Arabian scale – and to Iṣḥāq al-Mawṣilī – a well-known singer of the Abbasid period from which we have no extant works although some of his scattered quotes can be found in later works –, cf. [Farmer, 1966a, p. 1146], [Farmer, 1966b, p. 99], [Maalouf, 2002 (Chapter 2); Manik, 1969, p. 22; Shiloah, 1981, p. 29; Wright, Poché, and Shiloah, 2001, p. 800 (iv) Early theory – written by Wright].)

⁷⁷ A review of the main divisions of the fingerboard of the ‘ūd is proposed in [Beyhom, 2016, p. 79–80], in the section entitled “The ‘ūd as the ‘Monochord’ of the Arabs”.

⁷⁸ Some descriptions – as expounded later – include hand-shifts beyond the (just) fourth, sometimes for theoretical purposes (such as complementing the second octave of the scale). (See also footnote no. 418:184.)

⁷⁹ And “singing” (*ghinā’*) being ascribed to music practice – see for example [Farmer, 2011].

was only natural that this instrument became the preferred tool for theoretical explanations.

It is worth noting that even Kindī – the philosopher who was probably the most influenced by Plato⁸⁰ – could not contend himself with the precise, but nevertheless arbitrary explanations of the Pythagoreans and neo-Pythagoreans, and was compelled to include additional positions on the fingerboard of the instrument to reflect effective (Zalzalian) praxis.

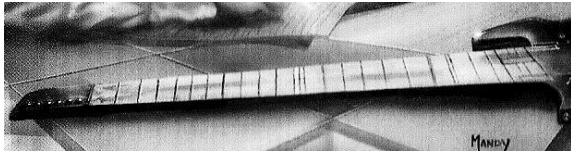

Fig. 6 An artist's view of a futuristic guitar.⁸¹

* * *

A. First description of the ‘ūd and of the division of the fingerboard by (al-) Kindī (c. 802-c. 866)⁸²

Yūsuf Abū Yūsuf Ya‘qūb ibn Ishāq ibn a-ṣ-Ṣabbāh ibn Ismā‘īl ibn al-Ash‘ath ibn Qays al-Kindī, whose father Ishāq was the Governor of Kūfā⁸³ under the reign of Abbasid Caliphs al-Mahdī (775-785) and a-r-Rashīd

⁸⁰ And probably Ptolemaeos – See footnote 89:124.

⁸¹ From the cover of [Sterling and Bear, 1996].

⁸² The dates of birth and death of Kindī are taken from [Guettat, 2004, p. 116]; these dates are controversial, as Farmer gives for example other dates (see fn. 84 below), [Ehwany (El-), 1966, p. 421] approximates them as (c. 185/801-c. 260/873) and Yūsuf, in [Kindī (al-), 1962a, p. 6], advocates for the approximate (801-866) as with the *Encyclopaedia of Islam* (see https://referenceworks.brillonline.com/entries/encyclopaedia-of-islam-2/al-kindī-SIM_4380?s.num=0&s.f.s2_parent=s.f.book.encyclopaedia-of-islam-2&s.q=al+kindī). [Adamson, 2011] (in the *Stanford Encyclopedia of Philosophy*) states: “We know that al-Kindī died after 866 CE, and his death date is usually placed in the early 870s. His birth date is harder to pin down, but he is said to have served as a scholar under caliph al-Ma‘mūn, whose reign ended in 833, and he was certainly associated with the court of the next caliph, al-Mu‘taṣim (reigned 833–842). He is thus usually reckoned to have been born around 800 CE”. {See also [Qiftī (Ibn al-), Müller, and Lippert, 1903, p. 366–378].} The *Fihrist* of (ibn a-n-) Nadīm [s.d., p. 315] confirms the surname and mentions 7 writings on music by this philosopher. {About the importance of (ibn a-n-) Nadīm and his *Fihrist* see [Neubauer, 2001a; Stewart, 2007].}

⁸³ Which is the probable birthplace of Kindī.

⁸⁴ [Ehwany (El-), 1966, p. 421] and [Wright, 2001c]. For [Farmer, 1929, p. 127], Kindī would be born in “al-Bāṣra” (Basra – Iraq) c. 790 and died in 874. Yūsuf, in [Kindī (al-), 1962b, p. 7], mentions

(786-809), stemmed from the South-Arabian tribe of Kindā (hence the origin of his second surname).⁸⁴

On the Philosophical and religious front Kindī was an adept of mu[‘]tazilism,⁸⁵ a theological school (and political party) which contributed notably in introducing Greek elements into Islamic thought. He was the *protégé* in Baghdād of al-Ma‘mūn⁸⁶ and of al-Mu‘taṣim⁸⁷, then fell in disgrace in 848⁸⁸. His library was then confiscated but was given back to him sometime before his death. Ehwany underlines one aspect of Kindī’s works which reconciles Hellenistic legacy with Islam:

“It was due to al-Kindī [Kindī] that philosophy came to be acknowledged as a part of Islamic culture. The early Arab historians called him ‘the Philosopher of the Arabs’ for this reason. It is true that he borrowed his ideas from Neo-Platonic Aristotelianism, but it is also true that he put those ideas in a new context. By conciliating Hellenistic heritage with Islam he laid the foundations of a new philosophy. Indeed, this conciliation remained for a long time the chief feature of this philosophy. Furthermore, al-Kindī, specializing in all the sciences known at his time – of which his writings give sufficient evidence – made philosophy a comprehensive study embracing all sciences [...]. Ibn Nabata, quoting [...] al-Kindī, mentions [...] the theoretical divisions. The philosophical sciences are of three kinds: the first in teaching (*ta‘lim*) is mathematics which is intermediate in nature; the second is physics, which is the last in nature; the third is theology which is the highest in nature. The priority of mathematics goes back to Aristotle but the final sequence of the three sciences beginning with physics came from the later

the birth in Basra as one possibility, concurrently with Kūfā. Kindī was also an algebraist in line with Muḥammad ibn Mūsā al-Khawārizmī (محمد بن موسى الخوارزمي c. 780 – c. 850). The latter, whose name was Latinized as *Algoritmi* – from which comes “Algorithm” –, was a mathematician, an astronomer, and a geographer during the Abbasid Caliphate, also a scholar in the House of Wisdom in Baghdad. {See also [Wikipedia Contributors, 2017a] and, more generally on Arabian mathematics and astronomy, [Siddiqi, 1966] – a domain which, however and according to [Colebrooke, 1817, p. lxxix–lxxx] and [Rosen, 1831, p. ix–x], owes more to Indian than to Greek science. One of the questions which is also (and still) raised today concerns the relation between Indian and Arabian musics at that time (and after), and cross-influence.}

⁸⁵ See also the re-evaluation of Kindī’s connection with the Mutazilites (adepts of a school of Islamic theology) in [Ivry, 1976], but also [Walzer, 1957, p. 15 sq.].

⁸⁶ Abbasid Caliph (813-833).

⁸⁷ Abbasid Caliph (833-842).

⁸⁸ Under the reign of al-Mutawakkil (847-861) because of a conspiracy due to the jealousy of two of the Banū Mūsā, the brothers Aḥmad and Muḥammad – according to [Ehwany (El-), 1966, p. 422] citing (ibn abī) Uṣaybi‘a (*Ṭabaqāt al-Aṭibbā’*; Cairo, Vol. 1, p. 207 – in fact *Uyūn al-Anbā’ fī Ṭabaqāt al-Aṭibbā’*, with numerous editions of which [Uṣaybi‘a (ibn abī), 1882]). (For Muḥammad ibn Mūsā, see [Hassaan, 2004].)

Peripatetics. Most probably al-Kindi was following Ptolemy, who gave a division of sciences in the beginning of *Almagest* [...]. Mathematics was known to the Arabs from that time as the ‘first study’.⁸⁹

It is to be noted, most interestingly, that Kindi was also a translator and a propagator of Ancient Greek writings from Syriac (and perhaps from Ancient Greek) language(s).⁹⁰ Furthermore, he was a theoretician of music and possibly a(n amateur) musician.⁹¹

Most importantly for us, he wrote a few epistles on music – of which four are extant –⁹² which greatly influenced his successors.

For different reasons – maybe because of his practical discourse on music – his epistles are almost systematically seen as a kind of auxiliary, a later additional documentation to the epistle of (al-) Munajjim (856-912 – See Appendix C for the epistle of this author).

However, mere chronology shows that the last assertion is false. Let us note that Kindi is the first who:

- wrote a *series* of epistles and treatises on music,
- integrated some theoretical procedures from Ancient Greeks (while also integrating other aspects

such as cosmology, numerology, *Ethos* theory and a description of the rhythmic system),⁹³

- clearly and explicitly described the tuning of the strings of the ‘ūd in successive fourths,⁹⁴
- mentioned some points regarding music practice,⁹⁵
- explained what where the ties used on the neck of the ‘ūd,⁹⁶
- gave a (nearly) complete organological description of the latter instrument, including a detailed description of the material and precise proportions for the strings,⁹⁷
- introduced the fifth (theoretical) string of the ‘ūd,⁹⁸
- considered a sixth hypothetical string while explaining the acoustical and organological reasons conflicting with this addition,⁹⁹
- and, finally, described a practical system for the mounting of the ties when applying them onto the neck of the ‘ūd, with an alternative system to ditonic Pythagoreanism coupled with indirect mentions of Zalzalian inclusions (*cf. infra*) to reflect musical practice.¹⁰⁰

⁸⁹ [Ehwany (El-), 1966, p. 424].

⁹⁰ [Ehwany (El-), 1966, p. 421].

⁹¹ [Ehwany (El-), 1966, p. 421] mentions an anecdote in (al-) Qifī’s “*Tārīkh [sic] al-Ḥukamā*”, Cairo edition, p. 241”, (the corresponding – and correct – citation would be *Tārīkh al-Ḥukamā* [Qifī (Ibn al-), Müller, and Lippert, 1903, p. 376–377]) relating the healing, by Kindi and through music, of a paralyzed boy. A-t-Tifāshī – a 12th-13th-Centuries author who wrote on music – describes, in the *Faṣl al-khiṭāb fi madārīk al-ḥawāss al-khams li-uli al-albāb* (Manuscript 118-06 Ennajma Ezzahra – Chapter 6; a printed edition [Tifāshī, 2019] is also – recently – available) the hypothetical use by Kindi of music to cure otherwise terminal diseases with patients, while Fārābī would have used a musical instrument to make people laugh, cry or sleep at will. Such anecdotes can be traced back to the Ancient Greek sources as found notably in [Grame, 1972, p. 26]: “Plato [...] was described as a brilliant performer who was able, by playing appropriate music, to affect his auditors so strongly that he could first calm them, then put them to sleep, and finally to awaken them. They tell us further that Aristotle, who attempted to emulate Plato in this respect, was able to send his listeners to sleep, but unable to awaken them! For this reason, according to the tale, he became the disciple of Plato.” See also in Shiloah’s translation [Kātib (al-), 1972, p. 45–46] (here translated from this French language annotated version): “It is also well known that Terpander [Terpandros] and Arion the musicians delivered the people of Lesbos and Antissa[?] from a plague that fell upon them, with melodies that they devised which relieved [the sick] from this pestilence.” {Note that there is generally much confusion in Greek names in the Early Arabic writings (at least those which I have consulted in my research) with – for example and in the Arabic language version published by Ḥifnī and Khashaba in Egypt [Kātib (al-), 1975, p. 23] – Terpander and Arion becoming “Therpidoros” (?) and “Odeon”, while Lesbos and

Antissa (which Shiloah corrected from “Anusa” or “Anisa” – pleading for Terpander to be born in the previous) become “Laris” (to understand as “Larissa”?) and “Anusa” (possibly “Anisa” – today on the site of Kültepe in Turkey). (I couldn’t get a hold on the original manuscript – copy? – of Kātib’s *Kamāl Adab al-Ghinā* which is supposed to be in Dār al-Kutub in Cairo.) Finally, note in [Kātib, 1973, p. 112] – which is Zakariyyā Yūsuf’s edition – Therpidros” (?) and “Arton” in “Laris” and “Anusta” (with question marks by the editor).}

⁹² From a total of about 270 writings which are ascribed to him [Ehwany (El-), 1966, p. 422]. There exist differing opinions about the number of his extant works on music (possibly 13), a discussion which exceeds the needs of the current exposé, but which is detailed in fn. 403 in [Beyhom, 2010b, v. 1, p. 122].

⁹³ Which are of lesser importance for our purpose.

⁹⁴ Notably in the *Risāla fi-l-Luḥūn wa-n-Naḡham* [Kindi (al-), 1965] examined *infra*.

⁹⁵ Which interest us in particular as for their incidence on the scale.

⁹⁶ See [Beyhom, 2010b].

⁹⁷ See Appendix A, notably FHT 2:158.

⁹⁸ The *ḥād* (a denomination which was adopted by his successors), which he also named “second *zīr*” or “lower *zīr*”.

⁹⁹ *cf. infra* the *Risāla fi-l-Luḥūn wa-n-Naḡham*.

¹⁰⁰ This last point alone explains why early commentators such as Farmer ignored this author, since his division could jeopardize the admirable structure elaborated around the “linear” evolution of the Arabian scale, originally devoid of Zalzalism – which allegedly came later to Arabian music. A second reason could be that Kindi’s

To conclude on Munajjim’s “precedence” in Arabian music theory: while Munajjim is presented as “revealing” the theory of Ishāq al-Mawṣilī (767-850)¹⁰¹ and considered to be the First Arabian theoretician of music, this persistent “mistreating” of Kindī the Philosopher¹⁰² (which Munajjim was not)¹⁰³ is totally unjustified and chronological *exposés* on Arabian music theory should clearly give precedence to Kindī.

The four epistles which were undoubtedly written by this author are, chronologically¹⁰⁴ and followed by the name of their dedicatees:

1. *Kitāb al-Muṣawwītāt al-Watariyya min dhāt al-Watar al-Wāḥid ilā dhāt al-‘Ashr[at] Awtār*: to Caliph al-Mu‘taṣim (833-842).¹⁰⁵
2. *Risāla fī-l-Luḥūn wa-n-Nagham*: to Aḥmad ibn al-Mu‘taṣim (son of al-Mu‘taṣim).¹⁰⁶
3. *Risāla fī Ajzā’ Khubariyya fī-l-Mūsīqā*: as above.¹⁰⁷
4. *Risāla fī Khubr [knowledge] Šinā‘at a-t-Ta’līf*: dedicated to one of Kindī’s late students.¹⁰⁸

Out of these, two, the *Kitāb al-Muṣawwītāt* ... and the *Risāla fī Ajzā’ Khubariyya fī-l-Mūsīqā* do not relate directly to the scale of Arabian music. The two other epistles, the *Risāla fī Khubr Šinā‘at a-t-Ta’līf* and the *Risāla fī-l-Luḥūn wa-n-Nagham*, are analyzed below.

master epistle, the *Risāla fī-l-Luḥūn wa-n-Nagham*, was known in Europe from an incomplete copy only, until the discovery by Zakariyyā Yūsuf of a complete copy in India.

¹⁰¹ Ishāq al-Mawṣilī was the most famous singer of the Abbasid era. His conflicting relation with his nemesis Ibrāhīm al-Mahdī is expounded in [Neubauer, 2001b; Meynard, 1869], with Neubauer explaining that Ishāq was “a court musician and companion (*naḍīm*) under every caliph from Hārūn al-Rashīd (786–809) to al-Mutawakkil (847–61). As an upholder of the classical Arab music style, he stood in opposition to the innovator Ibrāhīm ibn al-Mahdī and his followers”. See also the *New Grove* [Wright, Poché, and Shiloah, 2001, p. 800] in which Wright comments the relation between “Traditionalists” and “Modernists” at that time, notably: “[T]he extent to which variation might be either cultivated or avoided was also coloured by attitudes to tradition, and in parallel with the literary debate on the respective merits of the ancients and moderns, we find advocates of faithful musical transmission opposed to innovators. Chief among the latter was Ishāq al-Mawṣilī’s great rival, the princely amateur Ibrāhīm ibn al-Mahdī (779–839). Renowned for the quality and reputed four-octave range of his voice, he was portrayed as a champion of greater freedom of expression. The innovations espoused appear to have involved a further injection of Persian elements, but exactly what these might have been is by no means clear, for again we encounter curt indications of stylistic contrast rather than analysis. When used in relation to Umayyad musicians, the distinction between ‘heavy’ (*thaqīl*) and ‘light’ (*khafīf*) appears to have implied a contrast between a more complex and serious style and a simpler, gayer one, the former commanding more prestige, the latter greater popularity. In its Abbasid manifestation, however, it appears that the lighter, more Persian style involved an association of freedom of interpretation with greater melodic elaboration, in contrast to the sobriety of the traditionalists”. (Note here that while the relations between the Persian and Arabian musics have been argued by many commentators, but with no conclusive indications about which one consisted in what exactly, Jean During adds to this discussion – in a private conversation on the 9th of September 2020 – the following details which only confirm the “Oriental melting pot” at that time: “Ishāq al-Mawṣilī’s (Persian) style would have been sober, in contrast to his nemesis Ibrāhīm al-Mahdī the (Arabian) style of which would have been exuberant. According to Mashhun (as retrieved in the *Tārīkh-e musīqi-e iran*, vol. I. 1994, p. 119-121), Ibrāhīm al-Mawṣilī [the father of Ishāq], son of Mahān son of Bahman son of Pashank originated from the Fars [Persia] and emigrated to Kūfā

[in today’s Iraq]. He worked out music in Mosul [Iraq] for one year – hence his surname – then went to Ray [in Iran] to work with Javānīyeh, a zoroastrian originating from Abū ‘Alī [a harbour situated in the Western part of the Persian Gulf – today in Saudi Arabia]. Ibrāhīm marries Shāhak, an Iranian, and moves to Baghdad where he becomes the recognized entertainer known to us through literature on music of that time. Ishāq was born in Ray, learned the music trade from his father then afterwards with Zalzal (who – according to Mashhun was also of Persian origin).” In conclusion: knowing that the “Persian *wustā*” (Persian third) of the Early Arabian theoreticians was Pythagorean, and that Zalzal was supposedly the first to have introduced the “Zalzalian” (i.e. “Arabian”, i.e. non-Pythagorean) positions on the fingerboard, it seems impossible – at least today and especially as long as the trend in Oriental musicology is to incorporate all known characters of music in the nationalistic struggle between Arabs and Persians – to disentangle the knot of the relations between Arabian and Persian music(s) at that time.)

¹⁰² See footnote no. 76:122. Note however that Owen Wright, although he begins his explanations, in the second edition of the *New Grove* and for the aforementioned entry [Wright, Poché, and Shiloah, 2001, p. 800] (article “Arab Music”), with the Tonal system of Munajjim, specifies a little further: “Of particular importance are several short treatises of the philosopher al-Kindī (c801–c866), the first major theorist whose works are extant”.

¹⁰³ And neither was he a musician.

¹⁰⁴ According to Shawqī in [Kindī (al-) and Shawqī, 1996, p. 231].

¹⁰⁵ This is the second epistle in the compendium [Kindī (al-), 1962a] published by Zakariyyā Yūsuf.

¹⁰⁶ This is the fifth epistle out of five (of which one – the fourth, probably a translated excerpt from Euclid’s writings – is incorrectly attributed to him) in the compendium [Kindī (al-), 1962a] published by Zakariyyā Yūsuf, also published as a standalone booklet [Kindī (al-), 1965]. Another version was published by Yūsuf Shawqī in 1996. (See footnote no. 104.)

¹⁰⁷ This is the third epistle in the compendium [Kindī (al-), 1962a] published by Zakariyyā Yūsuf.

¹⁰⁸ This is the first epistle in the compendium [Kindī (al-), 1962a] published by Zakariyyā Yūsuf. It should be entitled, following the MS. British Library Or. 2361, f° 168 (see [Wright, 2006, p. 1, fn. 3]), *Risāla fī Khubr Ta’līf al-Alḥān*.

THE *RISĀLA FĪ KHUBR ŠINĀ‘AT A-T-TA’LĪF*¹⁰⁹

This epistle is the “typical” of Kindī, not because of its informative value, but because a copy existed relatively early in Europe at the British Museum under the reference Or. 2361 (Fig. 7). Its subject is doubtless about scale theory and melodic composition [*ta’lif*], a theoretical writing *par excellence*.

The manuscript, a copy dated 1622, is incomplete and fraught with errors.¹¹⁰ The description of the positioning of the fingers on the fingerboard of the *ūd* is also incomplete. However, it allows for the reproduction of the possible division(s) as shown in Fig. 8:127.¹¹¹

Evidently, different commentators propose different choices among the partitions shown on Fig. 8, where each may be disputable,¹¹² but possible. In the *Risāla fī-l-Luḥūn wa-n-Nagham*, Kindī brings a division resulting from equal-divisions of the string in opposition, immediately followed, however, by a theoretical Pythagorean partition as detailed in the next section.

B. Praxis – or Zalzal versus Pythagoras

The first descriptions of the theoretical system(s?) of Arabian music seem strangely familiar to researchers in the field of Greek music (or of “some” Greek music – especially with Pythagorean arithmetical speculations).



Fig. 7 First page of the *Risāla fī Khubr Šinā‘at a-t-Ta’lif* by Kindī (as shown in the compendium [Kindī (al-), 1962a, p. 46]. The image is treated for clarity.

While Kindī’s and Munajjim’s divisions of the fingerboard of the *ūd* mostly lack precision, connoisseurs of Arabian music may legitimately wonder about the absence of Zalzalism in these descriptions.

In opposition to these rare descriptions,¹¹³ numerous (later) accounts of praxis exist, notably with chroniclers such as Mas‘ūdī and Aṣfahānī, whose narrations remain, however, mostly anecdotal, or are limited to descriptions of the progress of the performance, or of its socio-logical dimension.¹¹⁴

¹⁰⁹ I base myself for the following on [Kindī (al-), 1962a] and [Kindī (al-) and Shawqī, 1996] to which must be added [Wright, 2006] with a critical evaluation of some of the aspects of the epistle.

¹¹⁰ According to the copyist (as reported in [Kindī (al-), 1962a, p. 66]), who notes that he copied from a version which is “defective and unauthenticated” [*saqīma wa ghayr mu‘tamada*].

¹¹¹ I do not give here details of the multiple, sometimes contradicting interpretations of this division which are explained in [Beyhom, 2010b].

¹¹² Because the choice of some positions and not others will remain arbitrary as long as another, complete copy, is not discovered (if ever).

¹¹³ Very few other theoretical descriptions are extant, for example from Khawārizmī, the Ikhwān a-ṣ-Ṣafā’, Naṣīr a-d-Dīn a-t-Ṭūsī, but these are mainly copies of Kindī’s or Munajjim’s divisions. None of these later writers – as far as we know – was a musician.

¹¹⁴ Note that Aṣfahānī mentions rhythms, and “modes” (*aṣwāt* – sing. *ṣawt*) which correspond to “courses” (as with Munajjim – See

Knowing that later authors such as Fārābī and Sīnā,¹¹⁵ who wrote voluminous books (or book chapters) on this subject and who had a more respectful attitude towards the “people of the Art” (*Ahl a-ṣ-Ṣinā’a* in Arabic), included explicit Zalzalism in their theoretical description, one cannot help but wonder at the fact that, as Wright wrote:

“Al-Munajjim’s¹¹⁶ neat 2 x 4 scheme probably also tidies up a more complex reality. One evident anomaly is that it takes no

account of the neutral 3rd fret said to have been introduced by Zalzal (d after 842), the ‘ūd teacher of Is[h]āq al-Maw[š]ili¹¹⁷ himself, and named after him (*wuṣṭā zalzal*)”.¹¹⁸

While these descriptions are accepted by most researchers, the reader may imagine my astonishment when I found mentions of practice in the very heart of Early Arabian Pythagoreanism, in the *Risāla fī-l-Luḥūn wa-n-Nagham* by Kindī which I examine below.

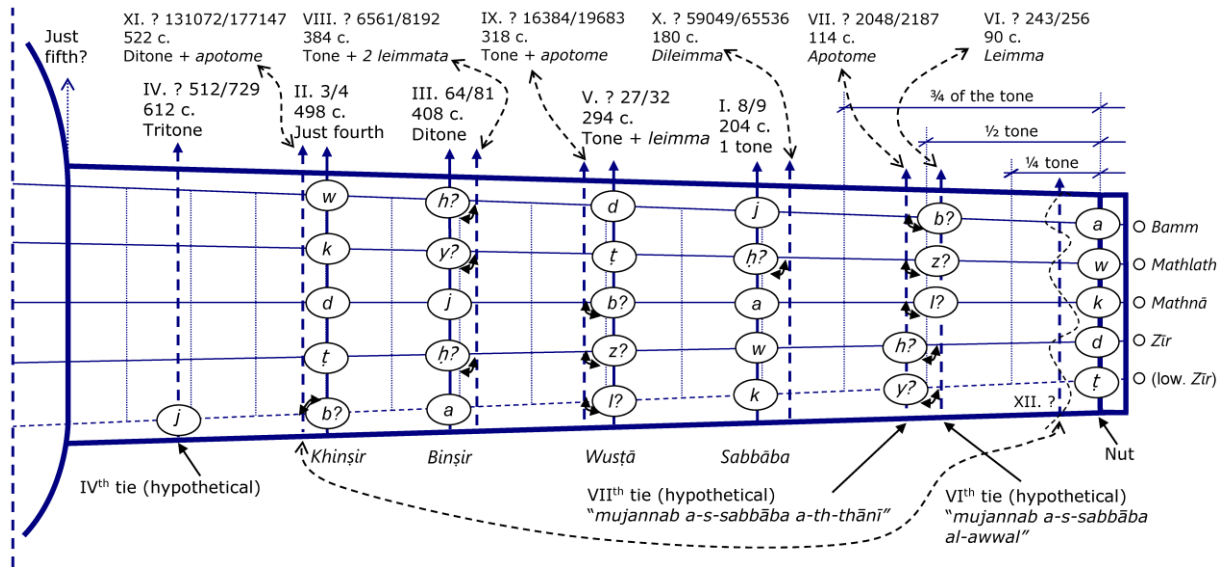

Fig. 8 Division of the (stylized) fingerboard of the ‘ūd in the *Risāla fī Khubr Ṣinā’at a-t-Ta’lif* by Kindī. The “ligatures” (positions of the *dasātīn* – “ties” in the figure) are mostly hypothetical due to the missing information in the epistle, but they are all possible. Positions are identified within the octave by the first 12 *abjad* (Syriac alphabet) letters *a b j d h w z ḥ ṭ y k l*. Kindī mentions a series of correspondences between octaves, fifths and (whole) tones, which explains the presence of numerous alternatives between *leimma* and *apotome* in the division. As a reminder: in the ‘ūd with 4 (ranks of) strings, the string which is lowest acoustically (and placed above on the figure for the instrument performed by a right-hand musician) is called the *bamm*, then consecutively (and respectively higher acoustically, while placed lower on the figure) the *mathlath*, the *mathnā* and the *zīr*. The fifth string (*ḥād* or “low. *zīr*” in the figure) is theoretical. “Ligatures” (vertical markers, “ties” in the figure) are generally attributed positions corresponding to the four fingers (excluding the thumb), beginning with the nut (*a*), then evidently the *sabbāba* (*b* – index), the *wuṣṭā* (*j* – middle finger), the *biṣīr* (*d* – annular) and the *khīṣīr* (*h* – auricular). Notes are thus identified by the string name and by the finger name. This is only practical when the division is limited to four ligatures (vertical markers): in more complex cases (such as with Fārābī – see « Impracticality of the performance with dense division » in Appendix B – Also see Fārābī’s division in FHT 17 in [Beyhom, 2016, p. 188] and, at the end of Part II, FHT 28:181 sq. – For “Figure Hors Texte” or “Plate” 28, p. 181), terms such as “the [first, second] neighbor” (which he named *mujannab* – pl. *mujannabāt*) of the *sabbāba* [or of the *wuṣṭā*]” are used to indicate the position of the vertical marker, although the *wuṣṭā*(s) can be differentiated as “Persian *wuṣṭā*”, “Arabian *wuṣṭā*”, etc.

Appendix C). He also frequently mentions the *wuṣṭā Zalzal*, the so-called “3rd fret” in the quote from Wright below in the text.

¹¹⁵ Which belong to the second period, the “Golden Age”.

¹¹⁶ See Appendix C – This division could be similar to the one by Kindī reproduced in Fig. 8:127, but more simple.

¹¹⁷ And also his uncle: see [Farmer, 1929, p. 124].

¹¹⁸ Wright in [Wright, Poché, and Shiloah, 2001, p. 802].

The reader may also wonder, as I wondered for some years after this discovery, how and why these indications by the leading theoretician at that time had been dismissed by successive generations of Orientalist musicologists,¹¹⁹ and this for more than two centuries.

As for local musicians (or musicologists), the reason for not questioning Orientalist writings is evident: the grand names of the “science” of musicology (Western and local) having spoken,¹²⁰ it becomes difficult to bring their “findings” to the test...

THE RISĀLA FĪ-L-LUḤŪN WA-N-NAGHAM BY KINDĪ

The contents of the epistle (*Risāla*) *fī-l-Luḥūn wa-n-Nagham* are described in details in Appendix A.3 of my (first) book on Arabian music.¹²¹ The description of the proportions of the *ūd*, the first one known to us, is reproduced in Appendix A in the current dossier, while the description of the “tie-frets” on the neck is included in Part II.

The epistle, which is written as a teaching manual for the *ūd*, has many useful indications on the practical aspects of the fabrication of the *ūd* and performance. When compared to the *Risāla fī Khubr Šināʿat a-t-Taʿlīf* reviewed above, it has a decisive advantage as it is complete, well written and is vocalized which helps understanding words or phrases that would be otherwise unclear. Its importance is crucial for our research as it contains the first description¹²² of actual “tie-frets” on the neck of the *ūd*, with precise and detailed explanations about their mounting and proportions.

Note that Kindi mentions three different tunings for the strings, the first (and most used) being successive just fourths,¹²³ while the two other tunings are variations with different resulting notes for the (unstopped) lower (acoustically) string (the *bamm*)¹²⁴ in order to underline particular tonic notes¹²⁵.

“Harmonic” and Pythagorean divisions

As mentioned in Appendix A, in this epistle Kindi provides the dimensions of the *ūd* in “full fingers”¹²⁶ (“ff” from this point on), a unit roughly corresponding to 2 cm (today). The vibrating string is 30 ff long with 10 ff (which is the third of the total vibrating length – see Fig. 9:131) over the fingerboard until the junction of the neck with the soundboard and the body. Tie-frets must not be mounted further as the fourth of the total speaking length (from the nut)¹²⁷ and are placed at the successive distances of 3 ff, 2 ff, 1 ff and 1½ ff, forming (with the strings) a “harmonic” division of the fingerboard (cf. Fig. 9). The reason for this positioning, which is a little far from the simple Pythagorean ditonic positioning, is given as practical, the author justifying his point by the necessity to use superparticular ratios (in the form $[n + 1]/n$) beginning with the “tenth of the string” and ending with its “half”.¹²⁸

The actual, physical ties must be “firmly tied at the back of the neck to avoid the possibility, due to their tension, of lateral displacement”¹²⁹. While this is an indication of Kindi’s practical concerns, tying the “frets” firmly is, however, premature, as further equivalences

¹¹⁹ And by their Arab (Persian, Turkic, etc.) students: these and their masters are so many that I do not bother mentioning them, although their writings are expounded in [Beyhom, 2010b].

¹²⁰ The problem with local musicologists is clearly a re-Orientalist matter: if they have recourse to Western musicological “science”, they are compelled to learn under the supervision of Western musicologists and as a result of these studies use the same biased tools Orientalist musicologists use for their descriptions of Arabian music; mostly, however, they are so overwhelmed by this “science” that they take the statements of their mentors for granted.

¹²¹ [Beyhom, 2010b]: other organological aspects, such as the thickness and material of the strings, are detailed in this reference, with the corresponding texts reproduced (in Arabic) in Appendix D.

¹²² And the only one, if not for a-ṭ-Ṭaḥḥān’s description explained below.

¹²³ [Kindi (al-), 1965, p. 16–17]: this is also the tuning used for theoretical descriptions (scale system).

¹²⁴ [Kindi (al-), 1965, p. 17–18]. In today’s practice, and depending on which mode is used, the *bamm* can also be tuned differently to suit the needs of the performer. (See next footnote.)

¹²⁵ There is a contemporary example with *maqām Sīkā* where the acoustically lowest string is frequently retuned to the note *SĪKĀ* (*e*⁻).

¹²⁶ This is a conventional reduction of the literal translation of (“أصابع ممتلئة حسنة اللحم”): “full fingers with good flesh”.

¹²⁷ [Kindi (al-), 1965, p. 11].

¹²⁸ The half of 1 ff, which the author seems to consider as a lower limit in this measuring method, prevents him from using some ratios such as the 1/9 of the string ($[30 \text{ ff}]/9 = 3,3333... \text{ ff}$), the eighth ($[30 \text{ ff}]/8 = 3,75 \text{ ff}$) and the seventh ($[30 \text{ ff}]/7 = 4,2857... \text{ ff}$), while the sixth (5 ff – position of the *wuṣṭā*), the fifth (6 ff – position *biṣīr*), the fourth (7½ ff – position of the *khīṣīr*), the third (when extrapolating, to get the fifth – 10 ff, which equates to the vibrating length over the fingerboard), including the half (octave at 15 ff) of the string are all compatible with this method (this line of reasoning is deduced from [Kindi (al-), 1965, p. 13]).

¹²⁹ [Kindi (al-), 1965, p. 12].

between octaves and fifths mentioned by the author compel to reconsider this initial division.¹³⁰

Equivalences of octaves mentioned by the author result in a modified placement of the tie-frets, shown on Fig. 10:131. The modifications make the first measurement procedure obsolete, as the new positions do not comply with a superparticular division of the string.

The result of further equivalences between notes a fifth apart (Fig. 11:132) is similar and implies a Pythagorean division of the fingerboard (practically)¹³¹ equivalent to the division expounded in the *Risāla fī Khubr Šinā‘at a-t-Ta‘līf* reviewed above (Fig. 8:127).

This result is not compatible with the initial (“Harmonic”) description, although it could be hypothesized that the differences of one *comma* between different positions of the ligatures would be considered as insignificant by Kindī.¹³²

However, the mere fact that Kindī explores octave and fifth correspondences compels us to consider both divisions, “Harmonic” and Pythagorean, as possible. Consequently, the placement of the “additional notes for singers” explained below is undertaken for both divisions.

Additional notes used by singers

At some point in his epistle after the description of the division of the fingerboard of the ‘ūd, Kindī adds

¹³⁰ If we follow the author’s indications, “frets” will have to be tied and untied repeatedly, which is unpractical.

¹³¹ The division in the *Risāla fī Khubr Šinā‘at a-t-Ta‘līf* can be interpreted in multiple ways as explained in Part A.

¹³² This would be plausible knowing the general propensity of the author to mimic Plato by despising “mixtures” of notes. Thus, in [Kindī (al-), 1965, p. 19] the philosopher “cites” (pseudo-)Plato who would have complained about the “aimless and endless *tarākīb* [combinations] of mixed notes”. Compare to: “Then, I said, if these [Dorian and Phrygian harmonies] and these only are to be used in our songs and melodies, we shall not want multiplicity of notes or a panharmonic scale? / I suppose not. / Then we shall not maintain the artificers of lyres with three corners and complex scales, or the makers of any other many-stringed curiously harmonised instruments? / Certainly not” – in [Plato, 1908, p. 399 C-D (Book III)]. While Kindī chooses here austerity (some would write “simplicity”) in music and endorses Plato’s complaints about praxis, the realities of music both in Ancient Greece and in the countries of the Arabian Empire at his time seem to be far different from the (too) simple Pythagorean scheme he adopts in theory.

¹³³ Besides being the first known literal (using intersections of strings and tie-frets – or tablature) notation of Arabian music, this musical exercise features two simultaneous and differentiated melodic lines.

some explanations about praxis, with regard notably the accompaniment of singers, and provides in the last part an exercise in form of tablature.¹³³ While explanations about singing practice are given, seemingly, with reluctance, the information about the “additional notes [used by singers] outside the tie-frets [*dasātīn*]” stands:

“It may be that singers use also a note [*naghma*] which lies outside of all the ligatures, that they name *maḥṣūra* [“compressed, limited”]. It lies outside of the ligature [*dastān*] of the *khinšir* by extending the auricular [*khinšir*], and behind this one also – at the same distance as the ligature of the *khinšir* – except that they move the *sabbāba* [index] to the ligature of the *wustā* [middle finger] or of the *binšir* [annular]”.¹³⁴

A thorough review of this quote shows that the author gives in fact indications for *three new ligatures*, or series of notes a fourth apart, the placement of which can be deduced in two steps.

1st additional ligature (series of notes): “It may be that singers use also a note [*naghma*] which lies outside of all the ligatures, that they name *maḥṣūra* [“compressed, limited”]. It lies outside of the ligature [*dastān*] of the *khinšir* by extending the auricular [*khinšir*]”.¹³⁵

Kindī mentions no string for the *maḥṣūra*: he considers hence, by default, that it applies to the four strings of the ‘ūd: this is indeed an additional ligature.¹³⁶ As for its positioning on the fingerboard, and knowing that the author does not mention a hand-shift for it – neither

¹³⁴ [Kindī (al-), 1965, p. 19]. These indications are remarkable as they underline a crucial difference between the practical modal system (by singers) and the theoretical system inspired by Ancient Greek theories. It suffices to remind the reader that Kindī considered music, as the Pythagoreans did, as a science: “The soul has an affinity with music – That is [the science of] the composition of melodies”, which is a quote from Plato in [Kindī (al-), 1965, p. 19]: “النفس تنكفي مع الموسيقى – أي تأليف الألحان”. This is possibly the first differentiation between *ghinā‘* [“singing”] and *mūsīqā* [“music”], the criteria differentiating praxis (“singing”) and theory (“composition on the instrument”) being in this epistle clearly stated.

¹³⁵ Excerpt from the previous quote from Kindī.

¹³⁶ Virtual, evidently and for many reasons which will become clear in Part II (where the process of the mounting of the ties in the *Risāla fī-l-Luḥūn wa-n-Naghām* is reviewed). Let us note for the time being that these additional “ties” would create, if they were to be materialized as “frets”, incommensurable problems within this process, which is already very debatable. Further, and while Kindī wishes in no way to step out of the framework of Pythagoreanism in his theoretical expounding of the “Arabian” system, this is another reason for him not to mention an exact position for the *maḥṣūra*, a position that he cannot quantify by giving a Pythagorean ratio for its interval, or that he simply did not bother to examine more thoroughly (as this is praxis, not theory). Only with Fārābī and (ibn) Sinā would

does he give its precise position – it should reasonably be situated somewhere between the just fourth (*khinšir*) and the just fifth, which could complement octave equivalences missing in his division (see Fig. 12:132).¹³⁷

However, the use of the term *maḥšūra* (“compressed, limited”) by the author compels us to consider other options that will become clear when we place the remaining “additional notes”.

As for the other two positions, we shall note that moving the *sabbāba* (the finger) towards the position of the *wuṣṭā* or of the *binšir* (the ligatures) corresponds to a hand-shift, or lateral displacement of the (left, for right-handed performers) hand towards the bridge in order to reach locations for the fingers which cannot be reached using the traditional hand position (Fig. 13:134).¹³⁸

The reason for this positioning *outside* the range of the ligatures (of the fourth) is that while the description of their mounting shows that they are material ties made of gut, positioning the finger between two (consecutive) tie-frets is unfunctional¹³⁹. In order to maintain the consistency of his demonstration, Kindī had to position these additional notes *outside of the fretted zone, after the khinšir* (and towards the bridge).

As for the remaining (two) series of notes:

2nd and 3rd additional ligatures (series of notes): “and behind this one also – at the same distance as the tie-fret of the *khinšir* – except that they move the *sabbāba* [index] to the tie-fret of the *wuṣṭā* [middle finger] or of the *binšir* [annular]”.

these “additional” positions be given “rational” quantification. (For the latter authors, please refer to Chapter II in [Beyhom, 2010b] for a complete review.) As we shall see in Part II, this mounting procedure is adapted only for the final aim of this epistle, teaching the rudiments of the technique on the *ūd*.

¹³⁷ The position of the *maḥšūra* cannot exceed the fifth as Kindī explains that one of the other additional notes is positioned *behind* the *maḥšūra* (further towards the bridge), and *before* the fifth.

¹³⁸ Note that hand shifting is – relatively – seldom mentioned in early Arabian writings, whenever today this has become a standard procedure in *ūd* technique as it has been for centuries for the European lute. Note also in [Sinā (Ibn) or Avicenna (980?-1037), 1956, p. 47–48]: “When it came to the insertion of melodic intervals [...] only three were inserted within the fourth [...]. The reason is the absolute necessity to appreciate the location of the fingers for the stopping of the strings on the ligatures [with Sinā these are vertical markers as shown in Part II]. There was a difficulty for moving the hand at the same time as moving the fingers. It was then agreed to keep the hand in a fixed position and to move the fingers only. The optimal position allowing for this movement was reached within the fourth of the string, on which was mounted the *khinšir*. With the thumb holding the instrument, the four [other] fingers could move within this fourth [of the string]”. See for example [Spencer, 1975,

If we sequence Kindī’s proposals, we can determine that these two series of notes can be found:

1. After the *maḥšūra*,
2. at a distance which is equivalent to the distance between the *sabbāba* and the *khinšir*,
3. with this distance being measured
 - from the *wuṣṭā*,
 - or from the *binšir*.

The first term of the sequence above is clear, showing that two additional series of notes are to be placed between the *maḥšūra* and the bridge (Fig. 12:132).

The second term must be understood as a distance, because if it must be the interval between the *sabbāba* and the *khinšir*, a Pythagorean “augmented second”, such “new” notes could be found on the lower string either on the estimated position of the *maḥšūra* (if the initial starting point is the *wuṣṭā*), or on the *sabbāba* (if the initial starting point is the *binšir* – Fig. 12:132). Assuming Kindī had in mind octave correspondences, the second series of notes would be superfluous, because it would already be delimited by an existing tie-fret. We are dealing with distances with this second term.

p. 352], where images 2 and 4 show the left hand position described by (ibn) Sinā, while images 1 and 3 show the left hand in shift position. Ligatures *a* and *b* are reached by moving the *sabbāba* (the – index – finger) towards the position of the *wuṣṭā* or of the *binšir* (the ties), which corresponds to a hand-shift, or lateral displacement of the (left, for right-handed performers) hand towards the bridge in order to reach locations for the fingers which cannot be reached using the traditional hand position. (Reminder and complement:) Hand shifting means moving the thumb towards the *wuṣṭā* or further, in which way further positions for stopping the strings (and further towards the bridge) can be reached by the other fingers, mostly the auricular for the further positions towards the bridge – see also <http://www.lutesociety.org/pages/beginners-lesson-3>, notably:

“The easiest and most efficient way to achieve [hand-shifts] is to simply pull the whole hand and forearm towards you to shift up (towards the bridge), and to push the hand and forearm away from you to shift down (towards the nut). Be careful not to twist the hand during shifts; common faults include moving the fingers but leaving the thumb behind, leaving the wrist sticking out awkwardly after the shift, and making excessive movements of the upper arm which leave the elbow sticking out”. (See also Fig. 13:134.)

¹³⁹ This is further explained in Part II.C.

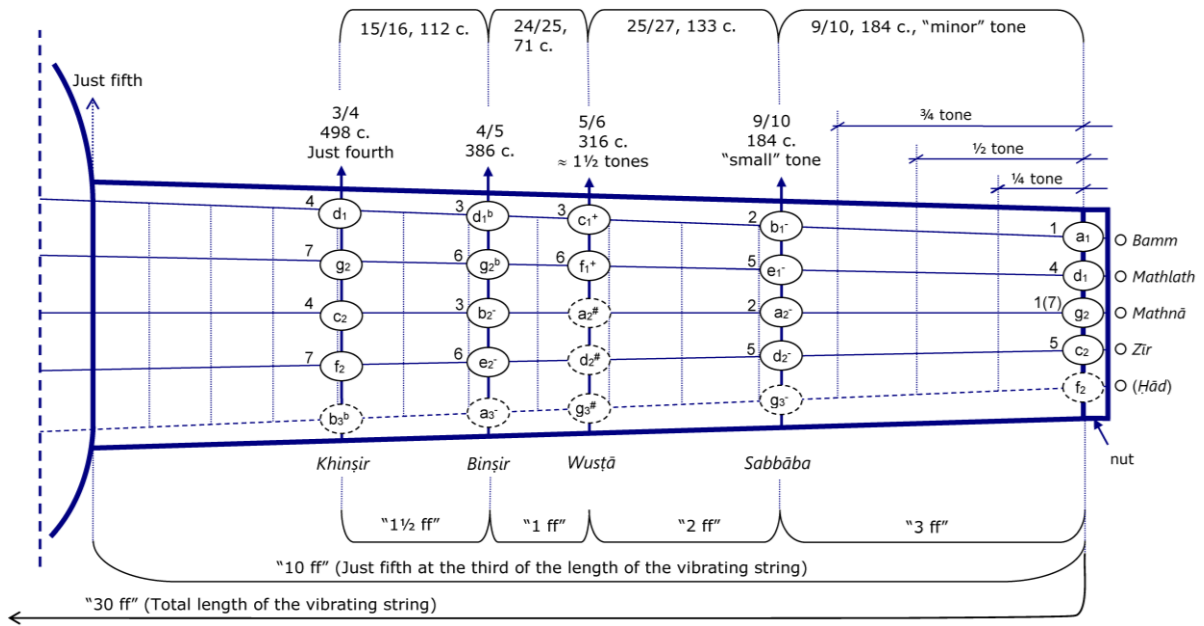

Fig. 9 Division of the fingerboard of the ‘ūd in Kindī’s epistle (*Risāla fi-l-Luḥūn wa-n-Naḡham*, in “full fingers” (= “ff” in the figure); the note corresponding to the non-stopped *mathnā* (g_2 in the figure) is called the *yatīma*¹⁴⁰. In the literal notation in the figure the g_2 is taken as the central note; the diesis “#” raises the note by one approximate *apotome* while the “b” lowers the note by the same amount; “+” and “-” signs are “corrections” with approximate value equal to one *comma* (or $1/8^{\text{th}}$ to $1/9^{\text{th}}$ of the tone) respectively higher or lower. Note that the *ḥād* string is hypothetical: Kindī further considers (see [Kindī (al-), 1965, p. 21]) adding one string still below the *ḥād* for the sake of demonstration of octave equivalences. (“Vibrating string” in the figure = speaking length of the string.)

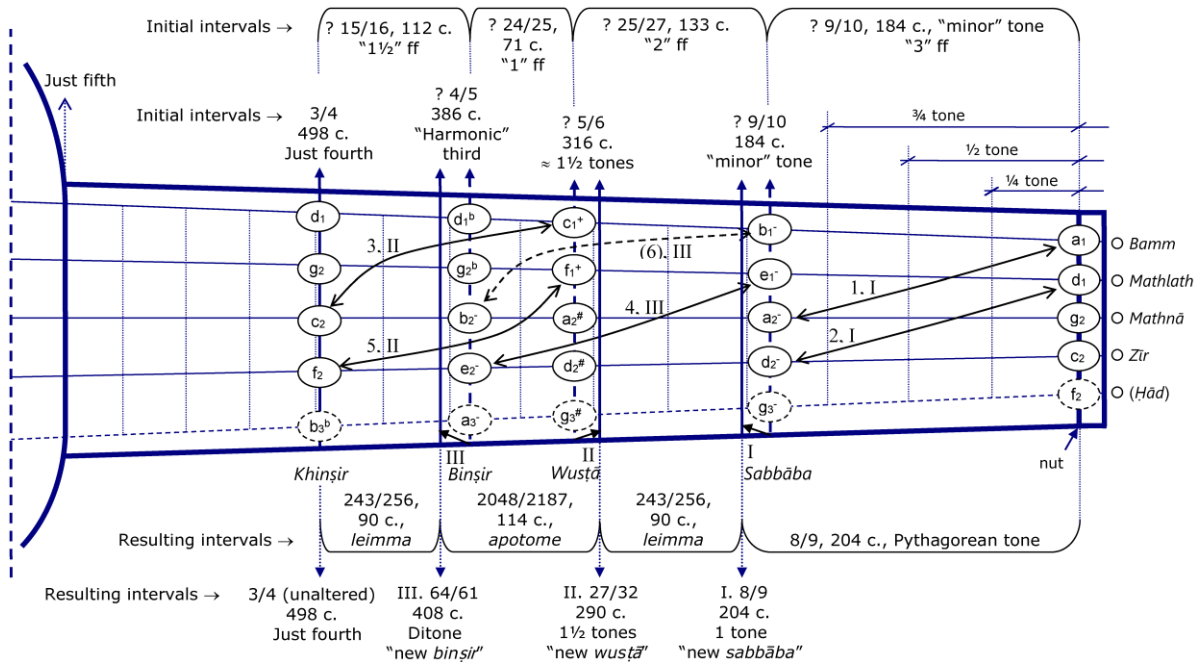

Fig. 10 Octave equivalences (in double-headed curves) as expounded in Kindī’s *Risāla fi-l-Luḥūn wa-n-Naḡham*, with sequential numbering (Arabic numbers) and consequent modifications (Roman numbers) of the positions of the tie-frets. The resulting system is Pythagorean ascending (two whole-tones and one half-tone from the nut to the just fourth) then descending one tone (from the *Khinšir* to the *Wustā*).

¹⁴⁰ The (she) “orphan”: so called because it does not have in practice a corresponding (higher or lower) octave, except for the approximate g_3^- on the hypothetical *ḥād* string (Fig. 9 and Fig. 10).

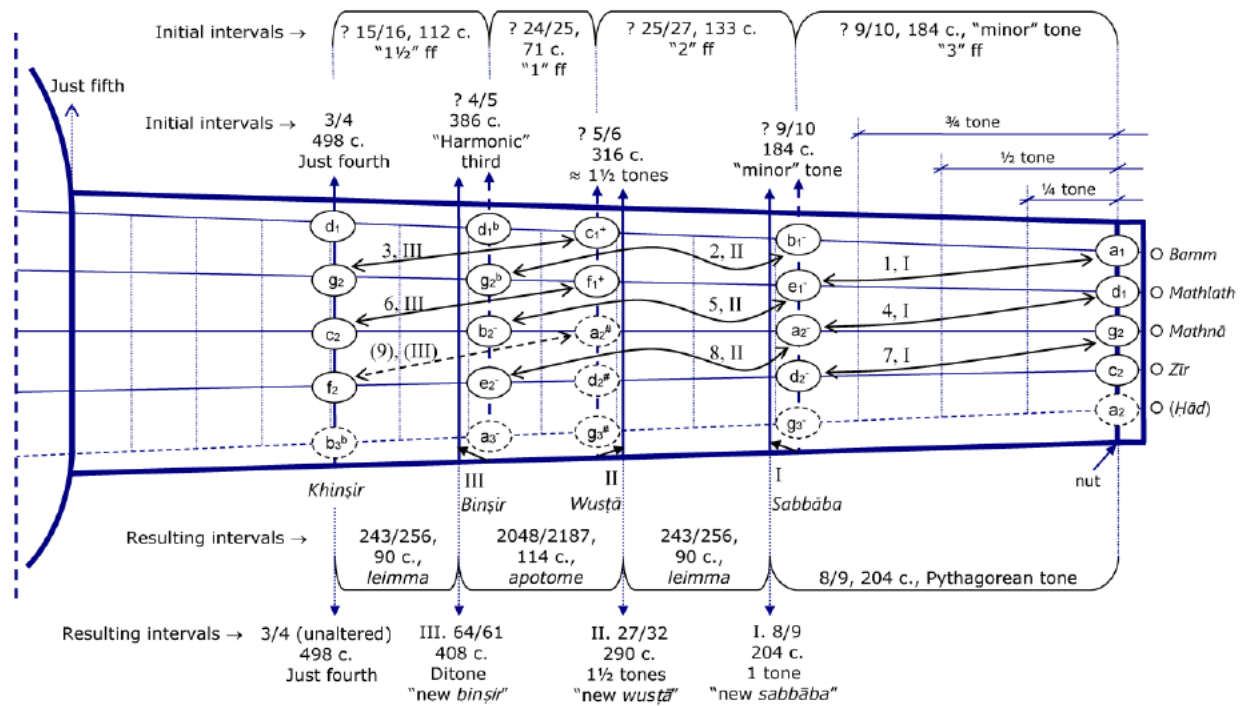

Fig. 11 Correspondences of fifths in the *Risāla fi-l-Luḥūn wa-n-Naḡham* by Kindī – as above.

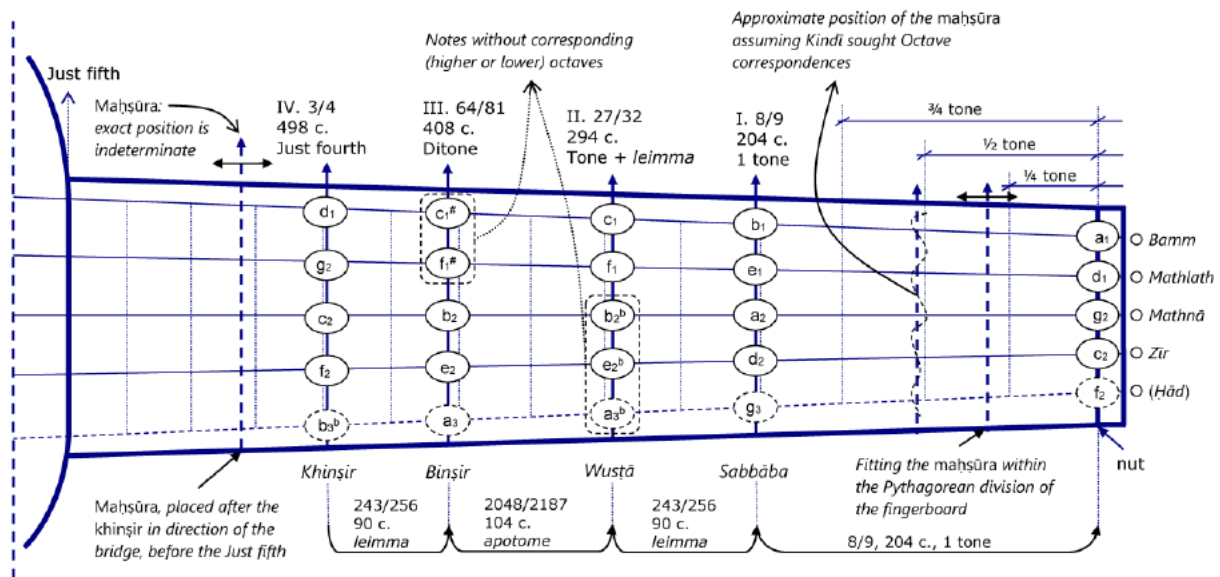

Fig. 12 Estimated inclusion of the *maḡšūra* on the fingerboard, and its placement within the Pythagorean division of the fingerboard of the *‘ūd* in Kindī’s *Risāla fi-l-Luḥūn wa-n-Naḡham*.¹⁴¹

Let’s call the distance between *sabbāba* and *khinšir* L_{s-kh} . It is equal to the fourth of the (total) speaking length of the string (from the nut to the *khinšir* – see Fig. 14:134) minus one ninth of the (total) speaking length of the string (which is the distance between the nut and the *sabbāba*) with:

$$L_{s-kh} = L_o(1/4 - 1/9) = L_o(9-4)/36 = 5L_o/36$$

(with L_{s-kh} = distance, or string part, between *sabbāba* and *khinšir*, and L_o = distance between nut and bridge, meaning the total speaking length of the string).

¹⁴¹ The *maḡšūra* is reached by extending the auricular finger towards the bridge.

This distance L_{s-kh} is to be measured towards the bridge from the *wuṣṭā* and the *binṣir* (Fig. 14:134). If we measure it from the *wuṣṭā*, the distance L_{s-kh} should be subtracted from the length of the string between the *wuṣṭā* and the bridge to calculate the resulting distance (let us name it L_{c-a}) from the bridge to the new tie (from this point on ligature “a”). While the distance between *wuṣṭā* and bridge is equal to the corresponding interval ratio multiplied by the string length ($27L_0/32$ – See figure), we can calculate

$$\begin{aligned} L_{c-a} &= L_0(27/32-5/36) \\ &= L_0[(27 \times 36) - (5 \times 32)] / (32 \times 36) \\ &= L_0[(972-160)/1152] \\ &= L_0(812/1152) \end{aligned}$$

or, by reduction,

$$L_{c-a} = 203L_0/288 \approx 0,7049L_0.$$

This first ratio corresponds to an interval with the value of 605,51 cents from the nut, rounded to 606 cents. When positioning the series of notes from the *binṣir* (Fig. 15:135), the same distance d must be subtracted from the string length between the *binṣir* and the bridge in order to find the resulting distance, (which we name $L_{c,b}$) between the bridge and the (second) new tie (“b”), the result of which, with calculations similar to the ones performed for ligature b ,¹⁴² is an interval with a value ≈ 743 cents,¹⁴³ with the (virtual) tie-fret b on the soundboard, near the junction with the fingerboard.

The *maḥṣūra*, the precise position of which remains however undefined, is “surrounded” by the *khinṣir* and ligature a (Fig. 14:134), which confirms its name.

Fitting these three new (and virtual) tie-frets within the Pythagorean division on the fingerboard (Fig. 15:135), we can see that the effective, resulting configuration that Kindī describes is in fact more

complex than the “neat [Pythagorean] 2 x 4 scheme”¹⁴⁴ and allows for Zalzalian intervals as well as for ditonic ones.

We shall also note that this is the first occurrence, in the Early period, of the division which would become the common denominator between all subsequent descriptions by major theoreticians of the Golden Age and the Systematists’ periods, the 3-intervals per one whole-tone division, 7-intervals per fourth and, adding one fourth and one whole-tone to complete the octave, the 17-intervals division of the octaves of *maqām* music.

The resulting “Harmonic” division of Kindī (see Fig. 16:135) has the same numbers of intervals in the whole-tone, the fourth and the octave, with however different values for the composing intervals than in the Pythagorean division. In this case the *maḥṣūra* justifies also its name as, while its precise position is still undefined, it is delimited by the *khinṣir* and ligature a , or – after fitting it within the Harmonic division – by the nut and ligature a' .¹⁴⁵

Remains the most important question: was the Early ‘ūd effectively fretted?

If we rely on Kindī’s description in this epistle, we may conclude as most our forbearers that “yes”, the Early ‘ūd was fretted. However, knowing that this is the only mention of material frets by Kindī, and that one single other description imitates him in the whole extant literature, we shall withhold our conclusion as many aspects of Kindī’s epistle must still be explained, as well as other descriptions which fully contradict the “fretting” thesis.

*
* *

¹⁴² The distance between the *binṣir* and the bridge being equal to $64L_0/81$ (see Fig. 14), we can calculate $L_{c,b} = L_0(64/81 - 5/36) = L_0[(64 \times 36) - (5 \times 81)] / (81 \times 36) = L_0[(2304 - 405)/2916] = L_0(1899/2916)$ or $L_{c,b} = 211L_0/324 \approx 0,6512L_0$. This corresponds to an interval value of 742,501 cents from the nut, rounded up to 743 cents.

¹⁴³ Similar reasoning applied to the first (“Harmonic”) division would give, for the ligature a , an interval with value 659 cents and,

for the ligature b , an interval with value 746 cents. Essentially, the two possibilities lead to the same conclusions expounded further in the text.

¹⁴⁴ As quoted from Wright at the beginning of Section B.

¹⁴⁵ The *maḥṣūra* could also correspond to the missing octave equivalences on *wuṣṭā* and the *binṣir*, which would complement the division of the fingerboard.

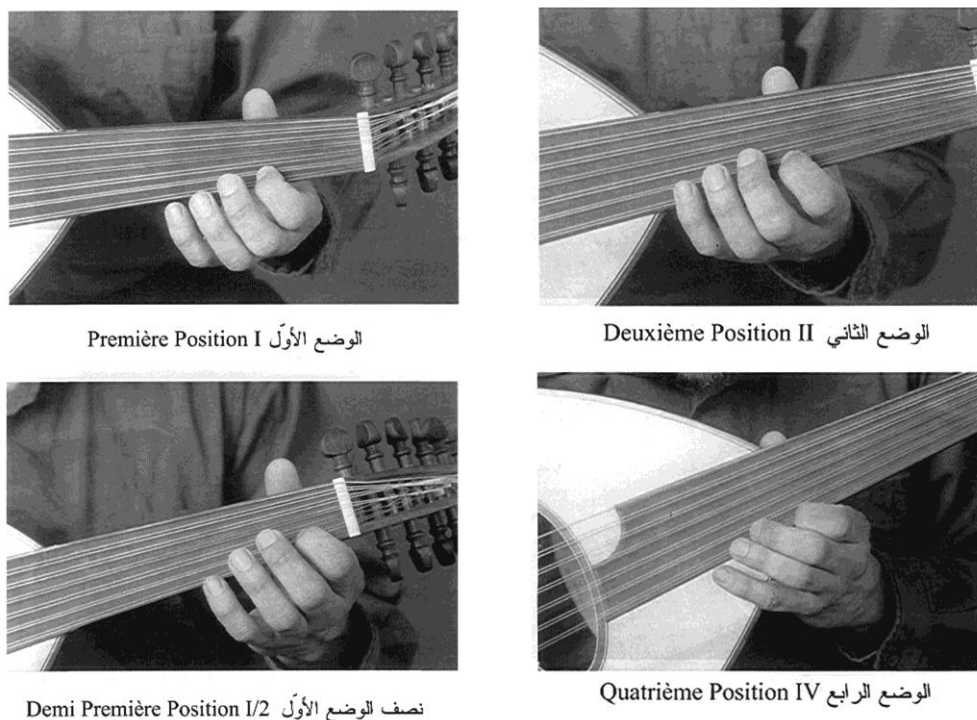

Fig. 13 Positioning of the left hand on contemporary ‘ūd(s) as shown in the opening pages of [Rūhānā and روحنا, 2001]. From top left to right then bottom left to bottom right: 1st position, 2nd position, 1st “half” position and 4th position. The two positions to the left are for traditional performance. The two positions to the right correspond to hand-shifts.

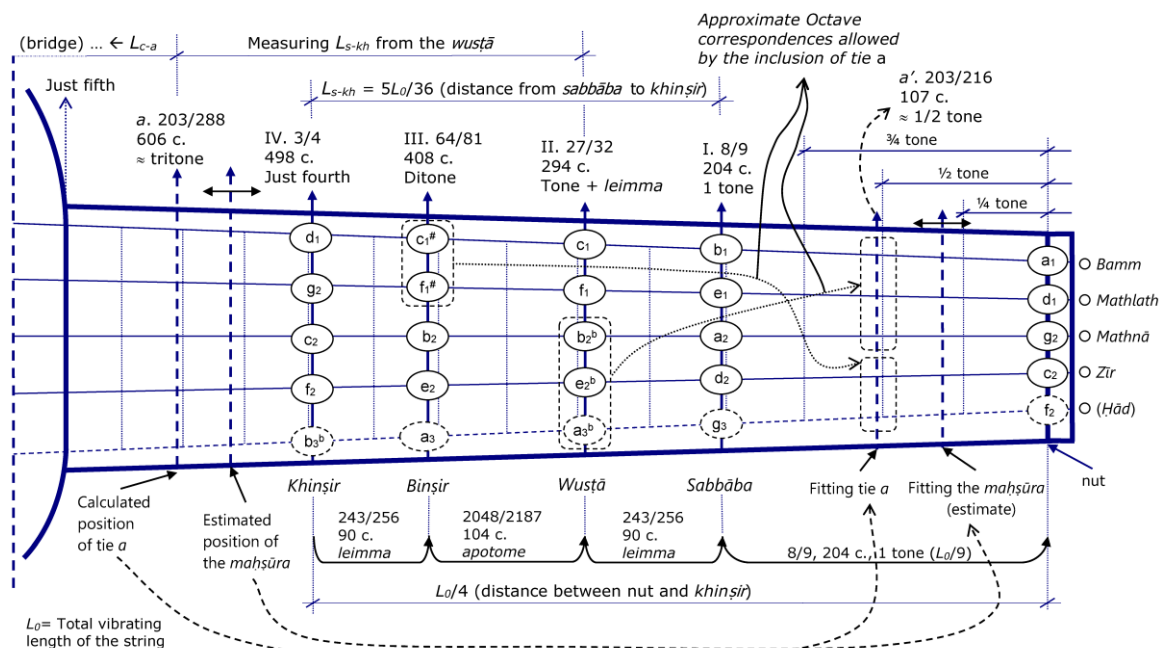

Fig. 14 Calculating the position of ligature *a* and including (then fitting) it in Kindī’s Pythagorean division in the *Risāla fi-l-Luḥūn wa-n-Naḡham*.¹⁴⁶ (“Tie” in the figure = “ligature”).

¹⁴⁶ The calculation of the distance between *a* and the nut was made by calculating the length of the string part which results from the addition of the equivalent of a fourth to section $L_{c-a} = 203L_0/288$ (by subtracting a fourth from the interval delineated by ligature *a*): it suffices then to multiply $203L_0/288$ by $4/3$ (being $812L_0/864$), and to simplify the result by dividing both numerator and denominator by 4, which gives $203L_0/216$.

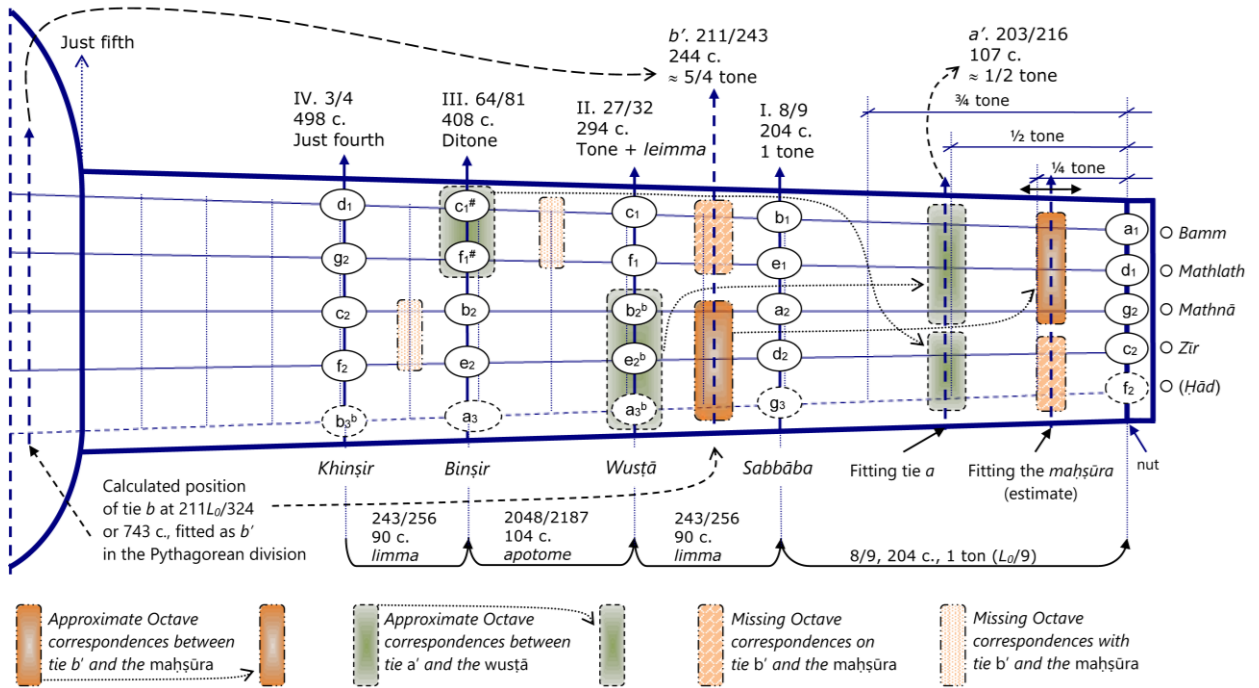

Fig. 15 Positioning ligature *b* with inclusion of the three new “tie-frets” (*a'*, *b'* and *maḥşūra*) within the Pythagorean division of Kindī in the *Risāla fī-l-Luḥūn wa-n-Naḡham*. (“Tie” in the figure = “ligature”).

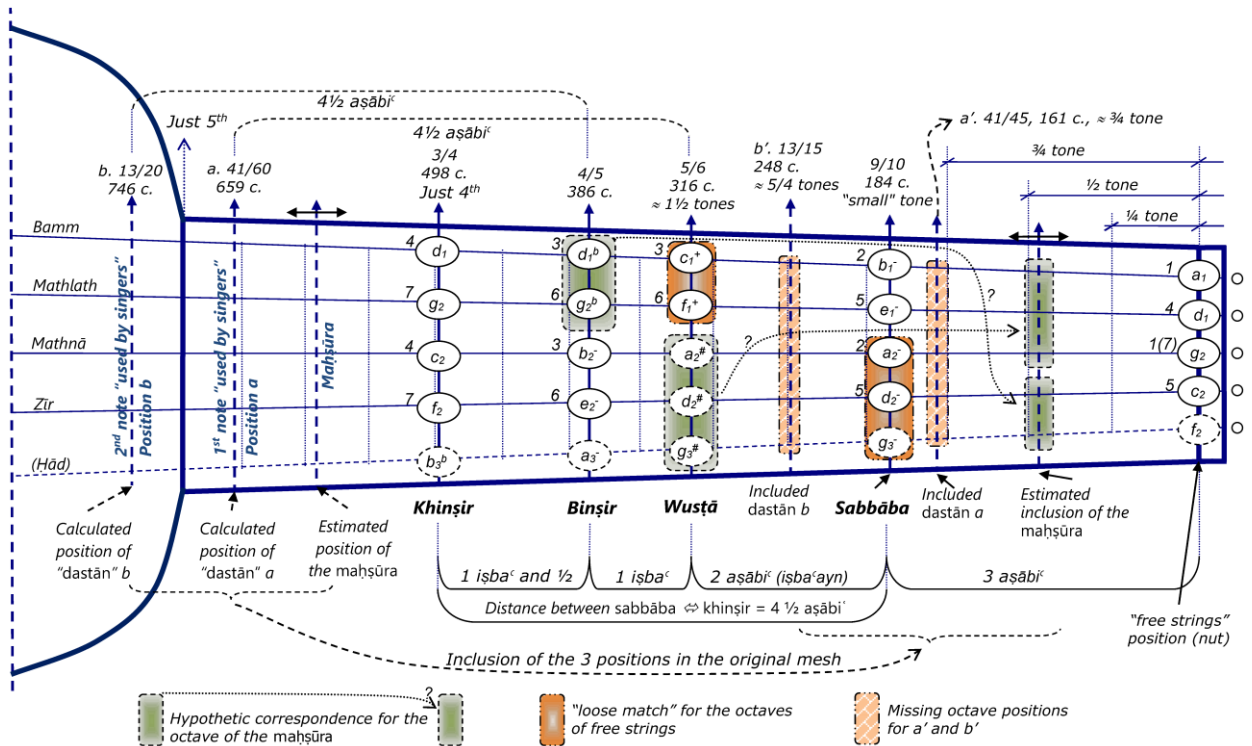

Fig. 16 “Harmonic” division of the fingerboard of the ‘ūd with Kindī’s indications on the “supplementary notes”, an alternative (based on praxis) division described by Kindī and totally overlooked by Orientalist (and re-Orientalist) musicologists – *isba'* (pl. *asābi'*, dual *isba'ayn*) means “finger(s)”, here the “full fingers” (“ff”) of Kindī.

PART II. ON “FRETS” AND “TIES” ON THE NECK OF THE ‘ūd

In this second part we shall examine one of the most debated questions in the history of (Arabian) music, the alleged fretting of the Early ‘ūd.¹⁴⁷ Opinions have been historically far apart on this subject, and changing. We have also seen in the first part that theoretical divisions of the fingerboard, although described as “purely” Pythagorean in the literature are, when it comes to facts (to praxis), approximate and Zalzalian. The problem that arises is that, given material “frets” as those advocated by Farmer and others, Zalzalian (*maqām*) music as described in the *Kitāb al-Aghāmī*¹⁴⁸ and many other sources would be impossible: how can then this contradiction be resolved?

I provide here a foretaste of the final answer proposed in this dossier: there is no solution to this problem, unless early ‘ūd(s) were never fretted – except for teaching or theoretical purposes.

* * *

Part II is divided in two main sections:

- A. A review of different opinions about the “fretting” thesis
- B. A historical clarification, and conclusions

¹⁴⁷ For the influence of the ‘ūd on Arabian music theory and praxis, see the entry for the instrument [Chabrier, 1982] in the *Larousse de la musique*, notably: “With the Abbasid Caliphs in Iraq, [the ‘ūd] becomes the conceptor of *genē* and modes of Meso-Islamic musics and the creator of melodies, a role maintained till today in both Arabian Popular and Art Musics”.

¹⁴⁸ See footnotes nos. 424 and 425:184.

¹⁴⁹ More precisely not before the publishing of my book [Beyhom, 2010b] (preceded by [Beyhom and Makhlouf, 2009]) in which this question was comprehensively examined and in which I concluded that (tie-)frets were not used unless for teaching or for theoretical purposes. To this day, I have not read, or heard of, a refutation of my demonstration.

¹⁵⁰ Manik uses the term *Lautenbinde* (“Lute-frets”) in German – see also the original text in Appendix D.

¹⁵¹ Once again: whose “Middle Ages”, and is such a time period pertinent even for Western History?

¹⁵² Manik cites here [Berner, 1937, p. 19].

¹⁵³ Manik cites here likewise K. Geiringer’s “Vorgeschichte und Geschichte der europäischen Laute bis zum Beginn der Neuzeit”, *ZMw*, x (1927–28), p. 570 (which I could not find).

A. Different opinions about the “fretting” of the ‘ūd

Although many Western “specialists” in Arabian music state(d) that the Early Arabian ‘ūd was fretted, this question was never really settled.¹⁴⁹ In 1969, Liberty Manik reviewed the arguments brought forward *against* this thesis:

“With regard the tie-frets¹⁵⁰ of the ‘ūd, which theoreticians of the Middle Ages¹⁵¹ have described in fine details to explain their [musical] system, Berner actually argues that these tie-frets never existed as this is, as he literally says, ‘pure fiction’.¹⁵² Berner refers for this to Geiringer who, after having determined that a lute with ties was not to be found in the iconographical context at that time, came to the conclusion that tie-frets were only used with the aim of measurement and research, and that these tie-frets could have no significance at all in [musical] practice.¹⁵³ Before that, Curt Sachs came to a similar conclusion”.¹⁵⁴

Manik takes sides against these opinions by arguing that a lack of proof (corroborating the mounting of tie-frets on the neck of the ‘ūd) is not a proof of the absence of tie-frets because (1) an image (or a sketch) is not a photography and (2) lack of proof *per se* is not enough.¹⁵⁵

To defend his thesis, Manik cites in a footnote Farmer’s article “Was the Arabian Lute fretted?”¹⁵⁶ together with Lachmann’s¹⁵⁷ and settles for the authority of these authors to conclude that “frets” were indeed mounted on ‘ūd(s) during the Golden Age¹⁵⁸ (the Western Middle Ages according to Manik).

¹⁵⁴ [Manik, 1969, p. 12]. Note that Manik’s reference for the last assertion corresponds to [Sachs, 1940, p. 254]: “Lutes seem to have no frets, either in older times or today, in spite of the constant use by the theorists of the word *dāsātīn* [*sic* – ‘*dasātīn*’], plural of Persian *dast* or ‘hand’, which is used to indicate frets. And it would have been difficult to string them securely around the sloping end of a pear-shaped lute [see Appendix B: Organological Clarification]. Very probably, the frets existed only theoretically to symbolize the positions of the stopping fingers”.

¹⁵⁵ Such arguments are totally acceptable *per se*, but the proof of the contrary was not provided either, as I explain further.

¹⁵⁶ [Farmer, 1937, p. 458].

¹⁵⁷ Reference to Lachmann, Robert, 1934, “Die Vinā und das indische Tonsystem bei Bharata”, *Zeitschrift für vergleichende Musikwissenschaft*, II, s. 64 (which I could not find).

¹⁵⁸ Manik’s argumentation is reduced to showing the inexistence of proofs for the presence of tie-frets on the ‘ūd, stating that the lack of evidence in the iconography does not confirm their absence, which he uses as an argument in favour of the “fretting” thesis. This is an arbitrary procedure as it is in every science. Furthermore, he

The thesis of the “fretting” of the ‘ūd is, consequently, based on already “old” (at the time of Manik) arguments from Farmer, Lachmann having simply followed Farmer in his argumentation as explained next. However, and due to the fact that Farmer’s writings remain an easily accessible reference for researchers,¹⁵⁹ this interpretation resurfaces regularly in the musicological literature¹⁶⁰ as explained in the introduction to this dossier for the *New Grove* and the *Encyclopedia of Islam*, to which should be added this statement by Farmer in his *History of Arabian Music...*:

“The ‘ūd *qadīm* or classical lute of four strings still continued to be favored,¹⁶¹ in spite of the introduction of the ‘ūd *kāmīl* or perfect lute of five strings, which was fretted according to the ‘systematist’ scale”.¹⁶²

In his book, as in the *Encyclopedia of Islam* to which he contributed, Farmer considered the fretting of early – and less early – ‘ūd(s) as fact. However, there are many indications which contradict Farmer and other proponents of the “fretting” thesis and confirm Sachs’, Berner’s and Geiringer’s opinion, especially for the “Systematist” scale as Farmer wrote.

*
* *

refers to Farmer and Lachmann without quoting them, and concludes in favour of the “fretting” thesis which is, to say the least, a flawed argumentation. The reader may compare this argumentation to Raasted’s conclusion on the ditonicity of the Byzantine chant “of the origins” in the section entitled *The “unambiguous supporting testimony” for the ditonicity of “Medieval” Byzantine chant* in [Beyhom, 2016, p. 235–236].

¹⁵⁹ Farmer contributed to many articles, for example, in the *Encyclopedia of Islam*.

¹⁶⁰ For example Bouterse’s article, entitled “Reconstructing the Medieval Arabic Lute: A Reconsideration of Farmer’s ‘Structure of the Arabic and Persian Lute’” [Bouterse, 1979], and his critique of Farmer’s description of Early ‘ūd(s). In spite of his critical attitude towards Farmer, Bouterse adopts the latter’s opinion: “As Sachs has pointed out, {citing [Sachs, 1940, p. 254]} frets would have been difficult to tie on the sloping neck, but [...] Farmer has conclusively proved that the Arabs did use frets on their lutes in the Middle Ages {citing ‘Was the Arabian and Persian Lute Fretted?’ examined further}” – [Bouterse, 1979, p. 2–3]. More recently, the advocates of the “fretting” had the strong support of Eckhard Neubauer in his

B. Historical clarification

FARMER’S “WAS THE ARABIAN LUTE FRETTED?” REVISITED

We saw that Liberty Manik, the 1969 author of a concise treatise on the theories of the scale of Early Arabs, supports the thesis of the “fretting” of the ‘ūd at that time, referring in so doing to Farmer. Returning to Farmer’s article,¹⁶³ we find from the outset Manik’s problematic stated in the introduction, in which Farmer cites an encounter with Lachman who (according to Farmer), was influenced by Geiringer’s¹⁶⁴ opinion about the absence of frets on the early ‘ūd(s), and asked Farmer if proofs of such fretting(s) existed.¹⁶⁵ A few lines further down Farmer cites Curt Sachs and his standpoint *against* the fretting thesis, while revealing concurrently Arabian musicologists’ dependence on Western musicological science:

“In 1932, whilst I was at Cairo at the Congress of Arabian Music, the question arose officially. At the plenary session of the Commission of Musical Instruments the well-known Egyptian musicologist Ahmad Amin al-Dik Efendi [...] suggested that frets should be adopted on the modern Egyptian lute (‘ūd) as in days of old. Dr. Curt Sachs, [...], who was President of the Commission, replied that the Arabian lute in days of old was *not fretted*. Several Egyptian savants and musicians questioned me privately at the time about Dr. Sachs’s statement. [...] I promised that I would deal with the question at length not only for its own sake, but in defence of my own thesis that Europe was influenced by the introduction of musical instruments with frets during the early Arabian culture contact”.¹⁶⁶

Having stressed, at the end of his introduction, his own intention to prove the existence of frets,¹⁶⁷ and having explained the issue and his own agenda, Farmer

article “*Der Bau der Laute und Ihre Besaitung...*” [Neubauer, 1993] which is examined further.

¹⁶¹ Farmer states here in a footnote: “It was still in use in the 15th century. *Bodleian MS.*, Marsh, 282, fol. 77”.

¹⁶² [Farmer, 1929, p. 208–209].

¹⁶³ [Farmer, 1937].

¹⁶⁴ Cited by Farmer in the same page mentioned by Manik.

¹⁶⁵ [Farmer, 1937, p. 453]: later, Lachman changed his mind (according to Farmer) and distanced himself from Geiringer on this matter.

¹⁶⁶ [Farmer, 1937, p. 453–454].

¹⁶⁷ To defend his thesis about the introduction of fretted lutes in Europe at the time of the first interactions with the Arabs as quoted above. The purpose of this demonstration was the justification of a wider thesis by Farmer on the influence of Arabian music on European music, advocated in [Farmer, 1930] with, notably in pages 104, 108, 112 and 363–364, the claim that Arabian music introduced harmony in Europe. The “fretting” thesis allows for steady

starts¹⁶⁸ by analyzing the term *dastān* used in the treatises for the “tie-frets”. He first quotes (al-) Khawārizmī¹⁶⁹ in his *Mafātiḥ al-ʿUlūm*.¹⁷⁰

Quote 1: “*dasātīn*”¹⁷¹ are the tied places (*ribāṭāt*) upon which the fingers are placed”.¹⁷²

Farmer immediately concludes:

“This definition is in itself quite sufficient to settle the question at issue. These ‘tied places’ were made by means of gut or string tied around the neck of the instrument”.

Many questions arise here. Firstly, why would these “tied places”¹⁷³, if these are tie-frets, need to be made “by means of” gut or string? Why are these tie-frets not simply “made of” any material, be it gut or anything else? Would Farmer have only given a reference for this material from which the tie-frets were (allegedly) made, then we would not have to ask the question. By returning to the original source,¹⁷⁴ we find that there is no single reference by Khawārizmī to the material from which the *dasātīn* (“ligatures”?) were made, and that the page cited¹⁷⁵ by Farmer contains only the description of the tuning of the *ʿūd* and the positions of the *dasātīn*.

intervals on the *ʿūd* which is in favour of polyphony (in Western mainstream thought); the ditonic thesis allows further for harmony in the Arabian Empire as early as Kindī (his “exercise for the *ʿūd*” in the *Risāla fi-l-Luḥūn wa-n-Naḡham* is explained by Farmer in p. 104 of the aforementioned reference).

¹⁶⁸ [Farmer, 1937, p. 454].

¹⁶⁹ Khawārizmī’s encyclopedia [Khawārizmī (al-), 1895] *Mafātiḥ al-ʿUlūm* [*The keys to sciences*] – edited by Van Vloten and which is most probably Farmer’s reference, contains 12 pages [235-246] expounding music, in Chapter VII of Book II. Guettat [Guettat, 2004, p. 115] cites an 1978 edition – I rely here on an edition from Beirut [Khawārizmī (al-), 1991], and on Van Vloten’s for confirmation.

¹⁷⁰ Further quotes of Arabian sources by Farmer and other authors are numbered from this point on.

¹⁷¹ (Reminder:.) Plural of *dastān*.

¹⁷² [Farmer, 1937, p. 454]. [Khawārizmī (al-), 1991, p. 210] has:

“واحدها دستان والدساتين هي الرباطات التي توضع الأصابع عليها.”

¹⁷³ This is effectively the first question as the terms “tied places” are a circumvolution for the word “ligature” (in French also “*ligature*”, in German “*Bund*”) which is the correct translation of the Arabic *ribāṭ* (sing. of *ribāṭāt*).

¹⁷⁴ [Khawārizmī (al-), 1991, p. 207–214].

¹⁷⁵ [p. 210] in [Khawārizmī (al-), 1991].

¹⁷⁶ Unless these “frets” are so thin (for example made of one or few silk strands the sole purpose of which being to materialize the positioning of the fingers, which means their purpose is indicative (showing the stopping points) and not effective (stopping the strings). While this problematic is explained further, it is worth mentioning that these tied threads would hardly hold on to the neck of the *ʿūd* (even less than ties made of gut, as explained in Appendix B).

The second main question which comes is Khawārizmī’s mention of the stopping of the string on the “tied places” which, as I show further, is incompatible with physical frets.¹⁷⁶

In the second part of his article,¹⁷⁷ Farmer informed the reader that “Frets (*dasātīn*) are frequently mentioned in the *Kitāb al-Aḡhānī*” by Aṣḡhānī,¹⁷⁸ and further refers to “the Arabic theorists”:

“their treatises **prove conclusively** that the lute (*ʿūd*) as well as the pandore (*tunbūr*) had these frets or *dasātīn* tied around the neck of the instrument”.¹⁷⁹

He also adds that Kindī, speaking of the *dasātīn* of the *ʿūd* in one of his epistles on music,¹⁸⁰ “shows [...] that they must have been frets”.¹⁸¹

We must note here, firstly, that the *tunbūr* and the *ʿūd* are different instruments,¹⁸² this difference lying mainly in the (relative) length¹⁸³ of the neck¹⁸⁴ but also in the playing techniques which, frequently, stem from the fretting, or from the non-fretting of these instruments.¹⁸⁵ Secondly, I have shown elsewhere¹⁸⁶ – and explain further in the following pages – that the *tunbūr*

¹⁷⁷ The remaining section of the first part of the article (§1) consists in a digression by Farmer on the terms *ʿataba* and *dastān* which is not relevant to our discussion (more information on this digression in [Beyhom, 2010b]).

¹⁷⁸ Which, in itself, does not inform us on the material from which these *dasātīn* (Farmer calls them “frets”) were made.

¹⁷⁹ [Farmer, 1937, p. 456]. (Bold type in quotes is mine, unless otherwise stated.)

¹⁸⁰ “British Museum MS. Or. 2361, f^o 165v^o”, see [Kindī (al-), 1962a, p. 51–53].

¹⁸¹ [Farmer, 1937, p. 456].

¹⁸² By equating *ʿūd* and *tunbūr*, and knowing that long-necked lutes are frequently fretted (see next footnotes), Farmer tries to reinforce his thesis for which he has, in fact, no solid arguments as shown further.

¹⁸³ The length is relative to the soundboard: short-necked lutes have (roughly) a neck which is shorter than half of the speaking length of the string, while long-necked lutes have a neck which is longer than half of the speaking length of the string.

¹⁸⁴ The *ʿūd* is short-necked while the *tunbūr* is long-necked.

¹⁸⁵ Long-necked lutes are mostly fretted (with exceptions, notably for some African long-necked lutes – see for example [Charry, 1996, p. 5–6]) while short-necked lutes are not fretted – with one notable exception, the European lute. In the latter case, however, it may be argued that frets (in fact “tie-frets”) were mounted to make the performance easier, notably for polyphonic purposes or to make it easier for non-professionals – for example nobles or high-classes representatives who wished to play easily on the instruments.

¹⁸⁶ See Appendix A.2 in [Beyhom, 2010b] for the descriptions of the *tunbūr* by Fārābī and Kātib.

(here “of Baghdād”) might as well be considered as having no frets at all.

Further: when returning to Kindī’s manuscript at the page cited by Farmer (f° 165v^o), we find absolutely no indication that the *dasātīn* may have been “frets” (or tie-frets). Kindī discusses in fact, in this folio (*recto-verso*), the *positioning* and the *locations*¹⁸⁷ of the *anḡhām* (notes) on the fingerboard of the ‘ūd, and mentions three times a *dastān* which coincides with one or another of these locations, while failing to inform us if these *dasātīn*, that he had not previously defined,¹⁸⁸ do exist physically.¹⁸⁹

Farmer continues his argumentation citing Munajjim¹⁹⁰ who explains:

Quote 2: “the place of every note (*naghma*) upon every fret (*dastān*)”,¹⁹¹

then Fārābī who, while describing the ‘ūd, would have written¹⁹²:

Quote 3: “that the *dasātīn* (frets) were tied (*shadda*) on the neck (*mul[s]tadaqq*) of the instrument, and that they were fixed parallel with the bridge-tailpiece”,¹⁹³

which corresponds to the original.¹⁹⁴

It seems here that, for the first time, Farmer’s assertions may come true. Still, we do not know what was the material used for the making of these “frets”... except for Farmer’s unsubstantiated statement at the beginning of his article.

Farmer further quotes (incompletely) Mas‘ūdī:

Quote 4: “the *dastān* next to the nut (*anf*) was to be placed (*mawḡūḡ*) on the fingerboard at one-ninth of the vibrating string-length”.¹⁹⁵

Mas‘ūdī, however, wrote in the Arabic version:

Quote 5: “*wa-d-dastabān*¹⁹⁶ *al-ladhī yalī al-anf mawḡūḡ* ‘*alā khaḡḡ a-t-tusūḡ min jumlat al-watar*”,¹⁹⁷

which can be translated as:

Quote 6: “the *dastān* which [immediately] follows the nut is positioned **on the line** of the ninth of the whole string”.

While still no material for the “frets” is mentioned by any of the authors quoted or mentioned by Farmer, he asserts further, without providing references to the reader, that the Ikhwān a-ṣ-Ṣafā’, (ibn) Sinā, (ibn) Zayla¹⁹⁸ and Ṣafīyy-a-d-Dīn al-Urmawī and others,

Quote 7: “**all confirm** the view that *dasātīn* were gut or string frets tied on the neck of the lute”,¹⁹⁹

which is absolutely unsubstantiated, as we shall see, and while still no precise references are provided describing the material (except for Farmer’s own assertions) and no indications about this material can be found in his article until this point.

As there is no other way to be sure of the material existence of “frets” on the neck of the ‘ūd, we must therefore try to find them in the works of the four authors mentioned by Farmer, but not referenced by him. The “Brethren of Purity” (Ikhwān a-ṣ-Ṣafā’) do mention,²⁰⁰ in their fifth epistle entitled *On Music (Fī-l-Mūsīqā)*, *dasātīn* which would be tied (*tushadd* تُشَدُّ) on the neck of the ‘ūd although they do not mention the

¹⁸⁷ 8 mentions at least of the words *mawḡaḡ* (“location”) or *mawāḡīḡ* (plural of *mawḡaḡ*).

¹⁸⁸ It is noteworthy that the first sheets of this manuscript were (and still are) missing in the copy cited by Farmer. These will be addressed further.

¹⁸⁹ While Farmer’s argumentation seems already, at this point, heavily flawed, intellectual integrity compels us to go along with his reasoning.

¹⁹⁰ “British Museum MS. Or. 2361, f° 236v^o”, see [Munajjim (al-), 1976, p. 189–209].

¹⁹¹ [Farmer, 1937, p. 456]: note that these are still indications about the *locations* of the notes on the *dastān*; note also that Farmer insists heavily on the word “fret” in his quotes. In the original [Munajjim (al-), 1976, p. 189] we find “*mawḡaḡ* kull *naghma* min kull *dastān*”:

“[...] موضع كلّ نغمة من كل دستان [...]”

¹⁹² So far in this discussion (and in his article), all of Farmer’s assertions turned out to be imprecise or, worse, flawed. Therefore, I am compelled to use the conditional mood.

¹⁹³ [Farmer, 1937, p. 457].

¹⁹⁴ [Fārābī (al-), 1967, p. 498–499]:

“وُشَدَّ عَلَى الْمَكَانِ الْمَسْتَدَقِّ مِنْهَا دَسَاتِينَ تَحْتَ الْأُوتَارِ تَحَدَّدَ أَقْسَامَهَا الَّتِي تُسْمَعُ مِنْهَا النِّغْمَ فَتَقُومُ لَهَا تِلْكَ مَقَامِ حَوَامِلِ الْأُوتَارِ، وَتَجْعَلُ مَوَازِيَةً لِقَاعِدَةِ الْأَلَّةِ، الَّتِي تَسْمَى “الْمُنْشَطُ”.”

¹⁹⁵ In a footnote (no. 2) on this page, Farmer gives as a reference for this description *Les prairies d’or*, viii, 99, which is flawed because Mas‘ūdī is otherwise not referenced in his article... I could nevertheless find the corresponding Arabic quote which is reproduced below.

¹⁹⁶ Mas‘ūdī uses the word *dastabān* in place of *dastān*. The editor of the Arabic version mentions (cf. fn. 1 in the reference of the next footnote) another version still of this term in one of the manuscripts he consulted for his edition, which is *rasān*.

¹⁹⁷ [Mas‘ūdī, 1987, p. 225]:

“والدستبان الذي يلي الأنف موضوع على خط التسع من جملة الوتر.”

¹⁹⁸ (Ibn) Zayla studied under the supervision of (ibn) Sinā – see more in [Beyhom, 2010b] and [Wright, 2001d].

¹⁹⁹ Still [p. 457].

²⁰⁰ [Ikhwān a-ṣ-Ṣafā’, 1983, v. 1, p. 203–204].

material from which these are made. (Ibn) Sinā does mention,²⁰¹ in the second part²⁰² of his last *discourse*²⁰³ that the *dasātīn* must be tied (*shadda*), but nowhere in his whole book-chapter on music is there a mention of the material of those *dasātīn* to be found. As for his student (ibn) Zayla, he also says that the *dasātīn* must be tied (*shadda*)²⁰⁴ on the fingerboard, but, although he, as did (ibn) Sinā,²⁰⁵ explains that in order to complete the second octave musicians must perform a hand-shift,²⁰⁶ he still does not mention the material from which the *dasātīn* were made.

As for Ṣafiyy-a-d-Dīn al-Urmawī, and while not knowing²⁰⁷ which of his two treatises was read by Farmer, I read both the *Kitāb al-Adwār* and the *Sharafīyya* looking for the *dasātīn*. At the very beginning of the 2nd chapter of the *Kitāb al-Adwār*, Urmawī explains:

Quote 8: “The *dasātīn* are marks which are put on the neck of stringed instruments following precise proportions to serve as locators for the emission of notes from parts of the string”.²⁰⁸

As for the *Sharafīyya*, in the fourth discourse (in which the division of the fingerboard of the *ūd* is explained), Urmawī likewise writes:

²⁰¹ In *a-ṣ-Ṣifā*, an encyclopedic work the 13th chapter of which is dedicated to music and was translated in French by Rodolphe d’Erlanger, cf. [Fārābī (al-) and Sinā (Ibn) or Avicenna (980?-1037), 2001, v. 2, p. 234–235] and Chapter II in [Beyhom, 2010b].

²⁰² Dedicated to musical instruments.

²⁰³ [Sinā (Ibn) or Avicenna (980?-1037), 1956, p. 144–145].

²⁰⁴ [Zayla (ibn), 1964, p. 74–75]; note also [p. 73] – “among [the instruments]: those with strings and *dasātīn* which are tied (*mashdūda*) at the locations of the notes, such as the *ūd* and the *tumbūr*”:

“منها: ذوات أوتار ودساتين مشدودة على مواضع النغم، لتنتقل الأصابع عليها في اتخاذ النغم، كالعود والطنبور.”

²⁰⁵ [Sinā (Ibn) or Avicenna (980?-1037), 1956, p. 144].

²⁰⁶ In the description of the two authors, the musician must perform a hand shift on the *zīr* (see for example Fig. 15:135) to reach the two notes g_3 and a_3 – these have correspondences on the theoretical string *hād*, but Sinā and Zayla are describing here the praxis – which means that, at least for the a_3 , the location of the “tie-fret” must be on the soundboard, which is incompatible with the “tying” of the *dasātīn*. In other words, the *dasātīn* either does not exist physically (its location can be simply marked on the soundboard) or the ligature is effectively a fret which is inserted on the soundboard. No such fret is however described by either of the two authors. Another possibility is that the *ūd* have a slender body at the junction with the neck, which is unlikely because Kindī’s and Ṭaḥḥān’s descriptions of the *ūd* (see Appendix A and [Beyhom, 2010b]) do not confirm such a shape.

Quote 9: “[...] and the *dasātīn* are marks put on the necks of stringed instruments to localize the positions dedicated to determined notes, and they are used for the appropriate composition [of music]”.²⁰⁹

Note also here two (later) indications by Shirwānī:²¹⁰

Quote 10: “and [the *dasātīn*] are marks put on the necks of stringed instruments to localize the positions dedicated to the sounding of specific string-parts”,²¹¹

and Lādhiqī:²¹²

Quote 11: “[there are] *dasātīn* in some instruments and these are marks which are put on the neck of stringed instruments to localize the positions dedicated to the sounding of specific notes in the course of melodies”,²¹³

which confirm, with practically the same words, Urmawī’s descriptions.

As a consequence of the last references it can be concluded, at this point, that the *dasātīn* do not compel the musician to play the notes at their exact position (they do not constitute a compelling temperament), but that their main function is indicative: they simply show *the locations* of the “ideal” (theoretical) notes which “compose the melodies”.

While these references show that Farmer’s argumentation, in this article, is at least unconventional, if not

²⁰⁷ Which also applies to Ikhwān a-ṣ-Ṣafā, (ibn) Sinā and (ibn) Zayla but, for these authors, I could find corresponding editions in Arabic; as for Urmawī, here is the reference provided by Farmer: “British Museum MS. Or. 136, f^o 235v^o”.

²⁰⁸ [Urmawī (d. 1294), 1986, p. 93]:

“الدساتين هي علامات توضع على سواعد الآلات ذوات الأوتار على نسب مخصوصة ليُستدل بها على مخارج النغم من أجزاء الوتر.”

²⁰⁹ [Urmawī (d. 1294), 1984, p. 141]:

“والدساتين هي علامات توضع على سواعد الآلات ذوات الأوتار ليستدل بها على مخارج نغم معلومة في أماكن مخصوصة ليستعان بها على التأليف الملائم.”

²¹⁰ See [Wright, 2001e] for more details on this author.

²¹¹ [Shirwānī (al-), 1986, p. 70] (French version available in [Shirwānī (al-) and Lādhiqī (al-), 1939, v. 4, p. 70]):

“فهذه سائر أمكنة الدساتين وهي علامات توضع على سواعد الآلات ذوات الأوتار ليستدل بها على مخارج النغم من أجزاء الوتر.”

²¹² See [Wright, 2001f] for more details on this author.

²¹³ [Lādhiqī (al-), 1986a, p. 59] (French version available in [Shirwānī (al-) and Lādhiqī (al-), 2001, v. 4, p. 292]):

“دساتين في بعض الآلات وهي علامات توضع على سواعد آلات ذوات الأوتار ليستدل بها على مخارج نغم مدار الالحان.”

flawed, his next argument²¹⁴ seems to be more consistent:

Quote 12: “If further proof were necessary one might quote from the *Ḥ[ā]wī al-funūn wa salwat al-mahzūn* of Abū-l-Ḥ[usay]n Muḥammad ibn al-Ḥasan, better known as Ibn al-Ṭaḥ[ḥ]ān²¹⁵ (fourteenth century?)²¹⁶, the only copy of which is in the Dār al-kutub at Cairo.²¹⁷ Ibn al-Ṭaḥ[ḥ]ān,²¹⁸ himself a musician, recommends the use of a pair of compasses²¹⁹ when fixing the places of the *dasātīn* on the neck of the lute. He tells us, however, that *he* did not need *dasātīn* on his lute because he knew the place of every note on the fingerboard without *dasātīn*. He says, further, that four rolls of gut string were required to ‘fret’ a lute, and he recommends that several thicknesses ought to be used”.²²⁰

Finally we have here a substantial indication by Farmer of the material existence of frets “made of gut strings”. Let us note, for future reference, that the provided pieces of information in the last quote are numerous and can be sequenced thus:

1. Locations of ligatures are marked, then these are mounted (it remains unclear however how) on the neck of the ‘ūd.
2. These ligatures are not of common usage, as (ibn a-ṭ-) Ṭaḥḥān does not use them.

²¹⁴ [Farmer, 1937, p. 457]; this description reminds of Kindī’s description in the *Risāla fi-l-Luḥūn wa-n-Naḡham*, reviewed further for the mounting of the *dasātīn*.

²¹⁵ “Ṭaḥḥān” means “miller” (see [Beg, 2000]); see also [Wright, 2001g] about Abū-l-Ḥusayn Muḥammad ibn al-Ḥasan ibn a-ṭ-Ṭaḥḥān al-Mūsīqī, and more about his and Kātib’s books (mentioned in the following quote) in [Wright, 1999, p. 545], notably: “Together with the *kamāl adab al-ghinā’* {by (al-) Kātib, available in French as [Kātib (al-), 1972] and in Arabic as [Kātib (al-), 1973; 1975] – also examined in [Beyhom, 2010b]} Ibn al-Ṭaḥḥān’s work provides an invaluable insight into the conceptual and analytical categories familiar to practising musicians in the major cultural centres in both Egypt and the Fertile Crescent during the first half of the period between the great theoretical syntheses of al-Fārābī in the tenth century and Ṣaḥī al-Dīn al-Urmawī in the thirteenth. Less systematic and more eclectic, with a greater interest in human behaviour and wit than mathematical abstraction, they embody a major strand in sophisticated urban culture, happily combining the presentation of specialist knowledge with a participation in the more general world of ideas by drawing upon and prolonging an already well-established literary tradition concerned with musical origins and the achievements of outstanding performers”.

²¹⁶ This is one additional example of Farmer’s hasty assertions as, in the article entitled “The structure of the Arabian and Persian Lute in the Middle Ages”, he confirms [Farmer, 1939b, p. 46–47] this information about (ibn) a-ṭ-Ṭaḥḥān living in the 14th century, while it is here tempered by a question mark. All of a-r-Rajab (cited in Yūsuf’s edition of Ṭaḥḥān’s *Ḥāwī al-Funūn wa Salwat al-Mahzūn* [Ṭaḥḥān (ibn a-ṭ-~ al-Mūsīqī), 1976, p. 2, fn. 5]), Neubauer (in

3. Ligatures are not necessary when the locations of notes are known to the performer.
4. If physical tie-frets are needed, gut strings can be used for this purpose.

From which it is easy to deduce that:

1. Mounting physical tie-frets is superfluous for confirmed musicians.
2. As a consequence of the previous point, ligatures were used only for beginners.

While remembering earlier quotes from Urmawī and other early authors, we may add two supplementary inferences:

1. Ligatures, whether physical (material) or not (for example markers on the upper side of the neck – which are still in use nowadays), serve primarily as locators of notes.
2. Ligatures are mainly used, in theoretical writings, to mark these positions.

Before going any further in our reasoning, it is time to examine more thoroughly the particular case of the ligatures on the *tunbūr* and the iconography of the ‘ūd (First and Second Interlude thereafter).

both his edition of the same [Ṭaḥḥān (ibn a-ṭ-~ al-Mūsīqī), 1990, p. iii] and in his article [Neubauer, 1993, p. 285] and [Wright, 2001g] place Ṭaḥḥān’s active period in the 11th century. As a further indication about the persistent influence of Farmer’s erroneous assertions on contemporary musicology of the *maqām*, Poché, in the entry ‘ūd of the *New Grove* [Poché, 2001, p. 27], mentions Ṭaḥḥān as active in the 14th century and refers for that to another of Farmer’s articles in *Studies in Oriental Musical Instruments* [Farmer, 1939a, p. 30], while concurrently citing Neubauer’s article of 1993 in which the latter corrected Farmer(!). (See also next footnote.)

²¹⁷ There currently exists (October 2017) three different copies of Ṭaḥḥān’s *Ḥāwī al-Funūn wa Salwat al-Mahzūn* in Dār al-Kutub at Cairo: (1) Funūn Jamīla 32, and (2) Ṭal’at 84 while the Funūn Jamīla 539 published by Neubauer is seemingly lost. According to Rosy Beyhom (personal communication) another version, (3) the M 1362, is certainly a photographed copy of the Funūn Jamīla 539.

²¹⁸ Farmer’s repeated errors with Arabic (and Persian) names and words may be an indication of his insufficient knowledge of the Arabic language. Bouterse’s article [Bouterse, 1979] explains some of the deficiencies in his translations (see also [Beyhom, 2011]).

²¹⁹ With the help of which marks can be made (lines, or segments of circles).

²²⁰ See [Ṭaḥḥān (ibn a-ṭ-~ al-Mūsīqī), 1990, p. 175-176 (89–90)]: Arabic original in Appendix D; additional explanations provided in [Beyhom, 2010b], notably in p. 520-521.

FIRST INTERLUDE: LIGATURES ON THE *ṬUNBŪR* IN EARLY ARABIAN DESCRIPTIONS

Farmer pretends that all the treatises of (some mentioned by him) early Arabian theoreticians “*prove conclusively* that the lute (*‘ūd*) as well as the pandore (*ṭunbūr*) had these frets or *dasātīn* tied around the neck of the instrument”²²¹.

The only extant early (till the 12th century) descriptions of the *ṭunbūr*, to my knowledge, are by Fārābī (9th century) and by Kātib (probably end of the 10th/beginning of the 11th centuries). None of the authors mentions any material for the ligatures or mentions that ligatures have a physical existence,²²² either for the *ṭunbūr* or for the *‘ūd*, while Fārābī specifies:

“It is possible that an uneven placement of the *dasātīn* on the *ṭunbūr* of Baghdad alters the consonance of notes, in which case it is necessary, in the course of performance, to use evenly disposed places between the existing ligatures, as described above for the *‘ūd*”^{223, 224}

Using intermediate positions, which change the pitch of the produced sound, is equivalent to say that the ligatures have no physical existence or that they are so thin that they do not have the function of tie-frets, but are markers for the positions of the fingers. A little further in his treatise, Fārābī explains (see Fig. 17:143)²²⁵:

“In our days, most Arabian users of the [*ṭunbūr* of Baghdad] neglect the *dasātīn* of the ‘Pagan times’²²⁶. They use the part of the fingerboard below *dastān* S-^cA and make of it the [new] *sabbāba* [index]. They put the *binšīr* [annular] below it in the direction of J, and follow up with the *khinšīr* [auricular]. They place their *khanāšīr* [pl. of *khinšīr* = auricular] farthest just

above the fourth of the length of the total string. As for the *wasatīyyāt* [pl. of *wustā* = middle finger], they make them between S-^cA and the locations of their *banāšīr* [pl. of *binšīr* = annular]. Most of them make the distances between their fingers equal, or close to the distances between the *dasātīn* except for the *sabbāba*, for which they use the last *dastān* of the *Jāhiliyya* which is *dastān* S-^cA”²²⁷.

Therefore, and according to the greatest theoretician of the Arabian Golden Age, the *‘ūd* and the *ṭunbūr* had *dasātīn* (“ligatures”). However, these *dasātīn* did not prevent performers to play between the ligatures, above them or below them, in which case the sounded pitches are modified.

Which makes me wonder if Farmer really read the authors he cites, or if he even wished to understand what they wrote.²²⁸

SECOND INTERLUDE: ICONOGRAPHICAL ARGUMENTS

One of the major arguments against the thesis of the “fretting” of the *‘ūd* was the lack of iconographical evidence. Farmer himself acknowledges this fact²²⁹ and mentions “hundreds of illustrations of the lute which reveal no trace of frets”, while reproducing²³⁰, as a contribution to his thesis, an illustration credited to Riḏ[ḏ]ā ‘Abbāsī and dated from the 1630s.

(d. 1294) and [Jurjānī (al-)], 1938, v. 3, p. 110] “two-stringed instruments” and refers to his *Kitāb al-Adwār* ([Urmawī (d. 1294), 1984, p. 44–45] or [Urmawī (d. 1294), 1986, p. 229–230]) in which Chapter 7 (in fact a long paragraph) is dedicated to stringed instruments, and where “ligatures” (*dasātīn*) are mentioned but not described. Likewise the “Brethren of Purity” mention [Ikhwān a-Ṣafā’, 1983, v. 1, p. 202] the *ṭunbūr* among a dozen other instruments but restrict themselves, in the following pages, to a description of the *‘ūd* and of its tuning.

²²⁹ [Farmer, 1937, p. 457–458]: “Although it is quite clear from literary sources that the lute of the Arabs and Persians was fretted in the early Middle Ages, it has to be admitted that our iconographical sources do not support this”, adding [p. 459]: “Clearly, iconography is an uncertain guide”.

²³⁰ Insert (Plate I) between [Farmer, 1937, p. 452–453], with the following acknowledgment: “(Reproduced by the courtesy of Messrs. Bernard Quaritch, Ltd.)”.

²²¹ Italics in the quote are mine.

²²² See the description of the *dasātīn* in [Kātib (al-), 1972, p. 89–91] and [Kātib (al-), 1975, p. 54].

²²³ See Quote 13:148.

²²⁴ [Fārābī (al-), 1967, p. 655]. The French version [Fārābī (al-), 1930, v. 1, p. 224] is different from my translation, but does not contradict it.

²²⁵ See also [Hassan, 1982, p. 10 sq.] for contemporary Iraqi *ṭunbūr*(s) with different divisions of the fingerboards.

²²⁶ Reminder (see footnote no. 45:119): *Jāhiliyya* (“Age of ignorance”) in Arabic.

²²⁷ [Fārābī (al-), 1967, p. 663–664]. The French version [Fārābī (al-), 1930, v. 1, p. 227] is (also) different from my translation, but does not contradict it.

²²⁸ Note that Urmawī does not even mention the *ṭunbūr* in his *Risāla a-sh-Sharafīyya* but mentions, in a very concise paragraph [Urmawī

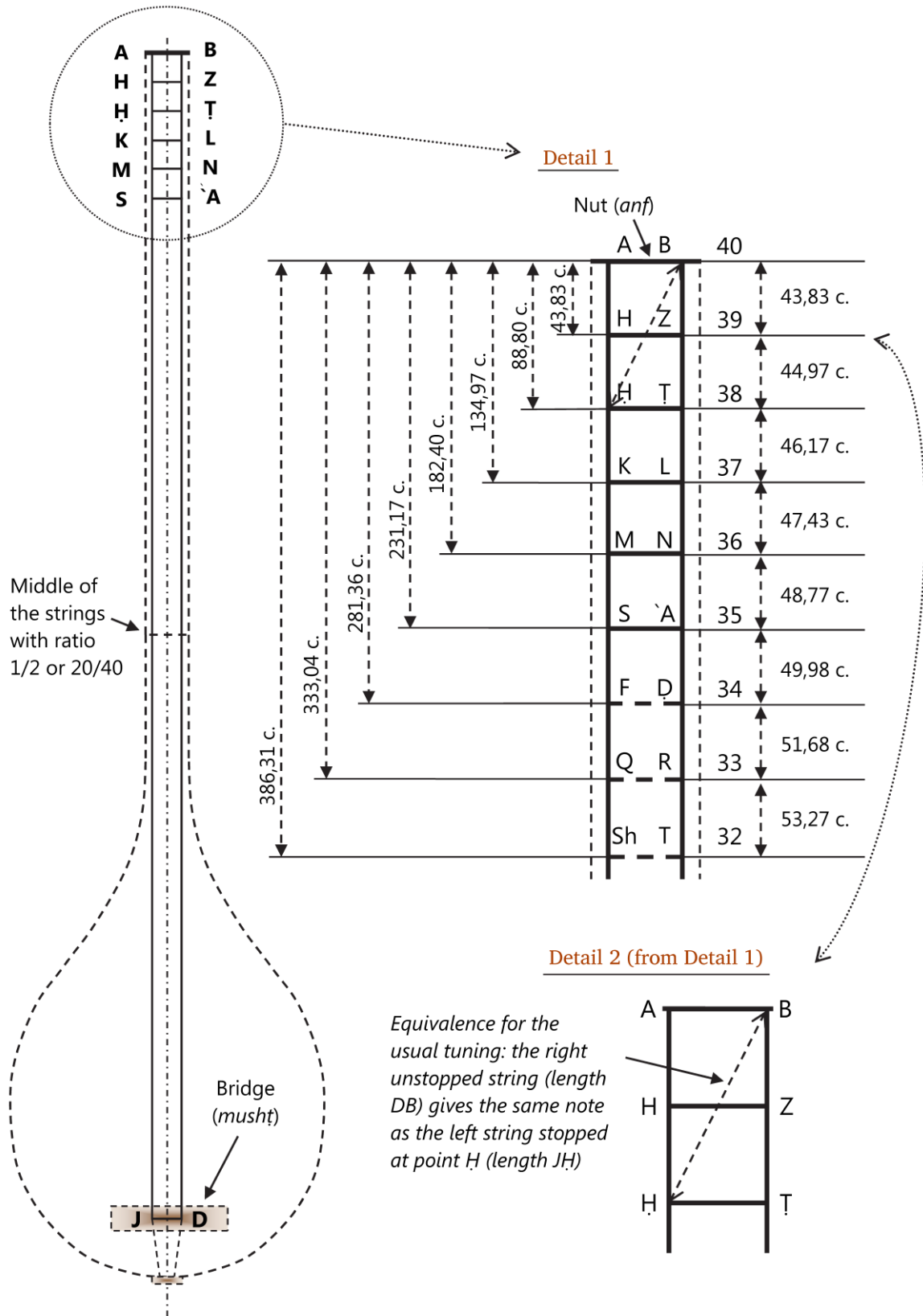

Fig. 17 The system of the *tunbūr of Baghdad* as explained by Fārābī.

It shows a lute-type instrument the fingerboard of which clearly bears marks perpendicular to the strings (Fig. 18:144). The drawing allows, however, no identification of the type of “tie-frets” (or to know if they have any physical consistency).²³¹



Fig. 18 “A Lute Player at the Court of Shāh Ṣafī (1629-1642), by Rizā ‘Abbāsī (?)”.²³²

Farmer was, there is no doubt about this, one of the best-placed Orientalists to dissert on the iconography of the *ūd*, and he was notably the editor, in 1966, of a compendium of illustrations on “Islamic music”.²³³ The mere fact that these illustrations were not used as potential “proofs” for Farmer’s thesis is somewhat disturbing.

On the other hand Liberty Manik, who cites no less than 9 of Farmer’s works along with at least 15 other references in French (including *La musique arabe* by Erlanger²³⁴), did not bother to consult Farmer’s aforementioned book²³⁵ published in Germany three years before

his thesis, as well as he did not bother consulting Erlanger’s book to verify if his thesis could be confirmed or infirmed.

This is even more disturbing when we know that Manik’s understanding of Arabian sources could have helped him substantiate his thesis, as the *Risāla fī-l-Luḥūn wa-n-Nagham* of Kindī, reviewed above for the description of the tie-frets, was published seven, then four years before the publication of his book.²³⁶

However, before reviewing this description, Fig. 19 is a remarkable example of “chimerical forms”²³⁷ for music instruments in the literature on Arabian music.

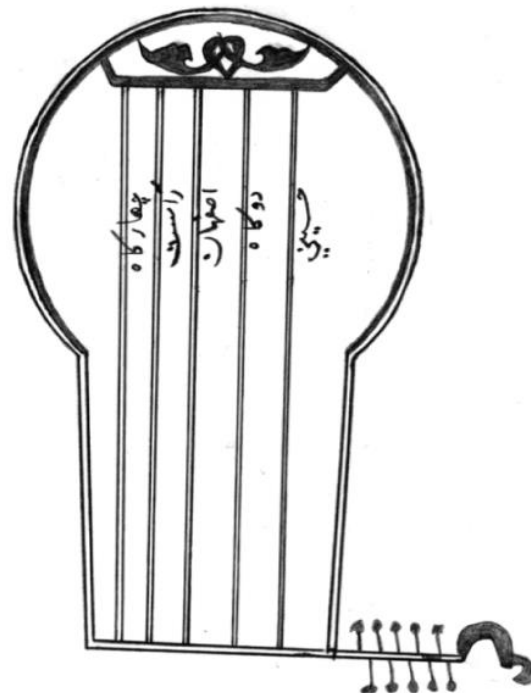

Fig. 19 Sketch of a *ūd* (duplicate from the original) from a Turkish manuscript from the Bibliothèque Nationale de France (BNF).²³⁸

Few other representations of the instrument are proposed in Fig. 20 to Fig. 24.

²³¹ And, this is no early *ūd*.

²³² [Farmer, 1937, Plate facing p. 453].

²³³ Farmer has published no less than 821 books, articles and Encyclopedia entries, of which 334 are dedicated to Arabian music and musicians; 121 additional works were still unpublished in 1999 (according to [Cowl and Craik, 1999]).

²³⁴ [Erlanger, 1930]. (The six volumes were published between 1930 and 1959).

²³⁵ [Farmer et al., 1966]. (Either Manik knew about this book and did not want to cite it, or he simply did not do a thorough research for the relevant literature.)

²³⁶ [Kindī (al-), 1962a ; 1965].

²³⁷ As Farmer himself describes them in [Farmer, 1937, p. 460].

²³⁸ From [Shiloah, 2002, p. 207]: this sketch is made by Rosy Azar Beyhom.

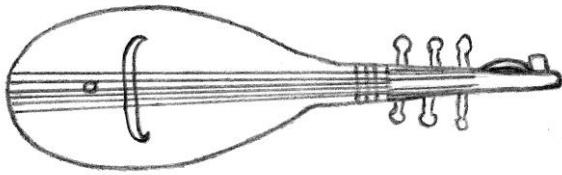

Fig. 20 Lute-type *vīṇā* found in representations from Amaravati, Nāgārjunakoṇḍa and Pawaya (India – Gupta period²³⁹).²⁴⁰

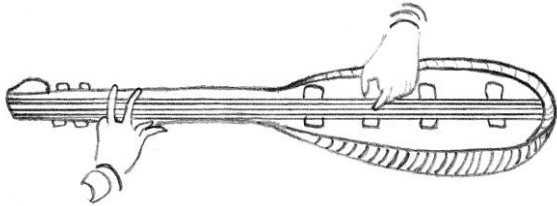

Fig. 21 Lute-type *vīṇā* – Pattaḍakkal (India, c 700 CE).²⁴¹



Fig. 22 Lute player and 6-stringed non-fretted *vīḍ*-type lute, Nāgārjunakoṇḍa. (India, 2nd-3rd centuries, bas-relief.)²⁴²

“In short”, I agree with Farmer that:

“whilst iconography has an undoubted value in recording the existence of classes of musical instruments of which no literary evidence has come down to us, we must always be critical before accepting the forms and details of such instruments”.²⁴³

* *

²³⁹ Between 320 and 480 CE.

²⁴⁰ Carbon copy by Rosy Azar Beyhom, from [Subramanian, 1985, p. 12, Fig. 8]. (This figure was previously published in [Beyhom, 2010b].)

²⁴¹ As above, from [Subramanian, 1985, p. 12, Fig. 9].

²⁴² This is to this day the oldest representation of a *vīḍ*-type lute that I could identify, taken from the booklet of [Zakir Hussain and Brij

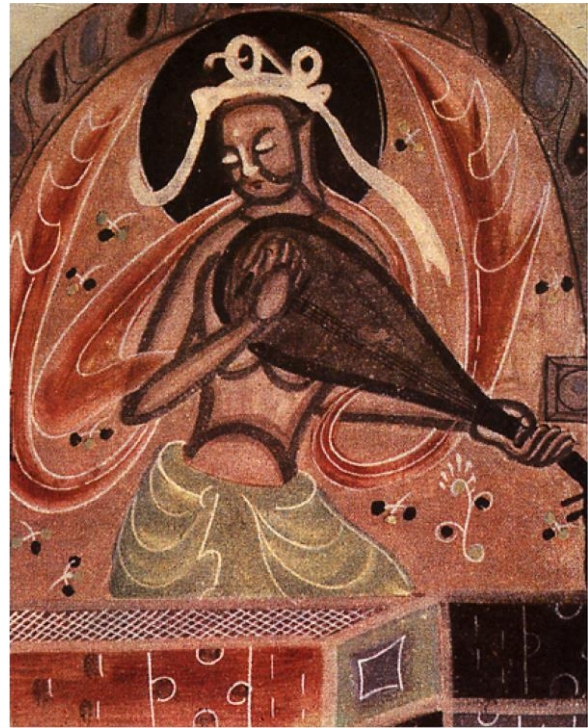

Fig. 23 Pipa-type 4-strings lute, mural painting no. 288 in the Mogao grottos (today in the Cansu province – China), North-Wei epoch (北魏), 4th century.²⁴⁴

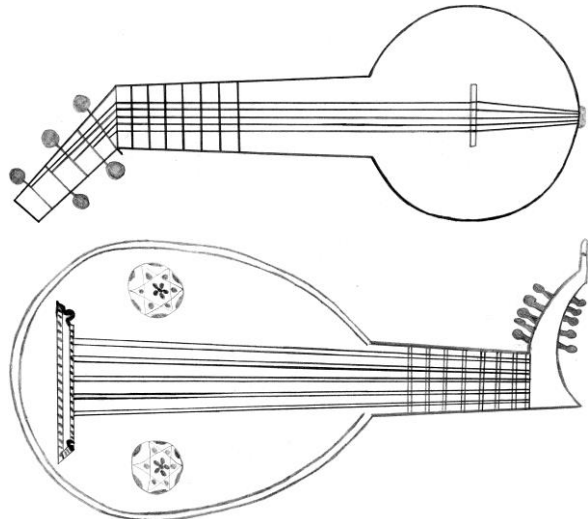

Fig. 24 Two sketches (duplicates from the originals) of so-called “fretted” *vīḍ*(s), allegedly with gut (or silk) strings tied around the neck.²⁴⁵

Narayan, 1990], and kindly provided by François Picard. (This figure was previously published in [Beyhom, 2010b].)

²⁴³ [Farmer, 1937, p. 460].

²⁴⁴ From [Liu et al., 1988, ill. II-86], kindly provided by François Picard. (This figure was previously published in [Beyhom, 2010b].)

²⁴⁵ (These sketches were drawn by Rosy Azar Beyhom, and were previously published in [Beyhom, 2010b] and [Beyhom, 2016].)

THE TIE-FRETS (*DASĀTĪN*) IN KINDĪ'S *RISĀLA FĪ-L-LUḤŪN WA-N-NAGHAM*

In the *Risāla fī-l-Luḥūn wa-n-Nagham*, unlike in other references cited by Farmer,²⁴⁶ the author (Kindī) thoroughly describes the material(s) used for the tie-frets, as well as their thickness proportions. Furthermore, it seems that Farmer had access to a copy of this epistle²⁴⁷ which, as he writes in a later article,²⁴⁸ he had consulted in 1926, and mentioned that the first folios were missing.²⁴⁹

The missing folios happen to be those where Kindī describes the tie-frets.²⁵⁰ The total speaking length of the strings is 30 “full fingers” (“ff”), which roughly equates to 60 cm. The first tie-fret, the *sabbāba* (index), is positioned (see Fig. 9:131) at a distance of 3 ff from the nut, and is made of a *bamm* string (the thickest and, acoustically, the lowest string) wound twice around the neck (Fig. 25). It is firmly tied²⁵¹ to avoid lateral displacements.²⁵²

The *bamm* string is made of four strands of homogeneous gut of constant cross section thoroughly twisted together (Fig. 26 and Fig. 27).²⁵³

The second tie-fret, the *wuṣṭā* (middle finger), is made of *mathlath* string, and mounted 2 ff away from the *sabbāba*. The *mathlath* string is made of three strands of twisted gut. The third tie-fret is wound 1 ff apart from the *wuṣṭā*, with a *mathnā* string made of twisted silk strands (Fig. 27) the section of which is equal to the section of two gut strands.²⁵⁴

The fourth tie-fret is mounted with a *zīr* string 1½ ff after the third tie-fret. The *zīr* string is made of twisted silk strands the section of which corresponds to the section of one gut strand.

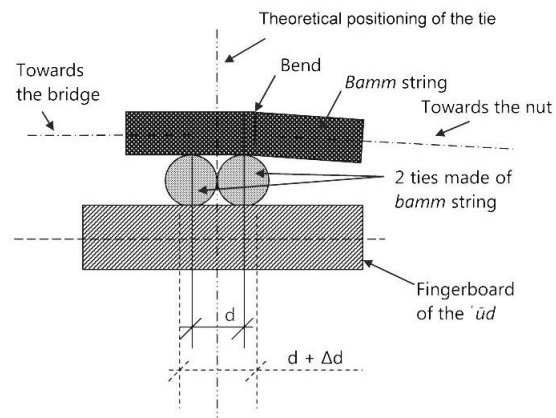

Fig. 25 The first (*sabbāba*) tie-fret (“tie” in the figure) described by Kindī and tangency point (“Bend”) with the *bamm* string. This is a side view (length section) in which d is the diameter of the *bamm* string, Δd is (twice) the undetermined error estimation – due to the elasticity of the composing gut-material – between the theoretical position of the tie-fret and the effective contact point of the mounted (and stopped) *bamm* string. The tie-fret, which is also made of a *bamm* string, is wound twice around the neck.

All these explanations by Kindī are clear and consistent, and show that, at least for this author, tie-frets made of strings were effectively mounted on the neck of the ‘ūd, contradicting thus Urmawī’s indications (Quote 8:140 and Quote 9:140) while confirming (*a priori*) the description of Ṭaḥḥān (Quote 12:141).

One undeniable contradiction is however raised by Kindī himself as he mentions in the same epistle notes performed outside the tie-frets, between the

Such sketches (above Fig. 84 in [Farmer et al., 1966] – taken from *Kanz a-t-Tuḥaf*, unknown author, Iran, mid-14th-century, British Museum MS. Or. 2361, f^o 260v^o; below Fig. 81 in [Farmer et al., 1966] – from the *Kitāb al-Adwār* by Ṣafīyy-a-d-Dīn al-Urmawī, Bodleian Library Oxford, MS. Marsh 521, f^o 157v^o, 1333-1334) served as “proof” that ‘ūd(s) from the Early Islamic Era were, like Occidental lutes in the Baroque and Renaissance periods, “fretted”.

²⁴⁶ Except for (ibn a-ṭ-) Ṭaḥḥān.

²⁴⁷ Which probably corresponds to the Berlin MS. Ahlwardt, 5530, f^o 25r^o – 31r^o, published as the fifth epistle in [Kindī (al-), 1962a].

²⁴⁸ [Farmer, 1939b].

²⁴⁹ [Farmer, 1939b, p. 43, fn. 2].

²⁵⁰ The missing folios correspond to pages 9–14 in [Kindī (al-), 1965], and the incomplete manuscript consulted by Farmer begins at the end of the first line of page 14.

²⁵¹ This contradicts Kindī’s further indications for octaves and fifths correspondences as the knots would have to be undone and done repeatedly.

²⁵² [Kindī (al-), 1965, p. 12]: the other tie-frets are described on this page and the following.

²⁵³ [Kindī (al-), 1965] [p. 15]: descriptions for the material of other strings are given on this page.

²⁵⁴ The reasons invoked by Kindī [p. 16] for this change of material are firstly that the sound of silk strings is “purer” for higher notes such as on the *zīr*, and secondly that the *mathnā* and the *zīr* need to be tensioned to such an extent as to possibly rupture were they made of (one or two) gut strands, whenever silk strings would not. The complete original quote for [Kindī (al-), 1965, p. 12–16] is available in Appendix D.

tie-fret of the *khinšir* (auricular) and the bridge, maybe even on the soundboard of the instrument.²⁵⁵

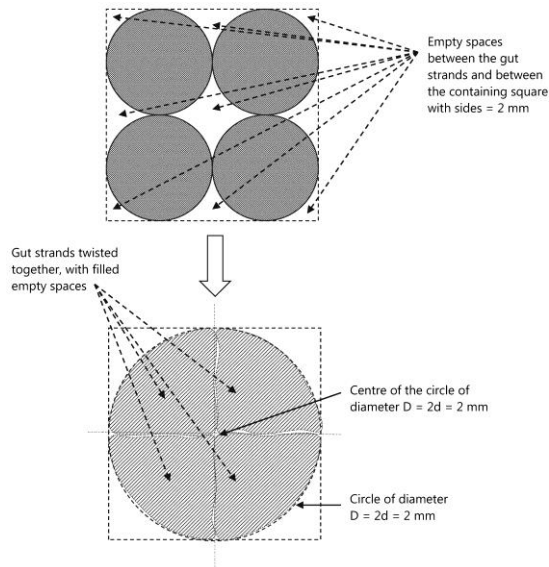

Fig. 26 Result of the (thorough) twisting of the 4 gut strands to make the *bamm* string on the ‘ūd (the figure shows cross sections of the gut strands). If the gut is 1 mm wide (diameter = 1 mm), the resulting string will have a diameter D of approx. 2 mm.²⁵⁶

We need therefore additional information in order to be able to conclude on this subject, which we

²⁵⁵ As seen in Part I.B of this dossier.

²⁵⁶ Given d_1 as the diameter of one gut strand (assuming it was already treated as to have a homogeneous density), the cross-section of one strand is $\pi \times (d_1)^2$. A good twisting – depending also if the gut is wet or dry – discards the empty spaces between strands in such a way as to form one gut string of circular cross-section the diameter of which we name d_2 . The cross-section of the *resulting string* is equal to the cross-section of the 4 strands of gut twisted together to form the string, i.e. $\pi \times (d_2)^2 = 4 \times \pi \times (d_1)^2$ which, after simplification and reduction, gives $d_2 = 2 \times d_1$. Four considerations are important for this reasoning: firstly, in the case of not sufficient twisting, there will remain tiny empty spaces between the strands, which results in a slightly greater diameter of the string. Secondly, while a gut strand is initially hollow (tubular), and while Kindī does not mention a prior twisting of the gut strands, we can assume that d_2 will be smaller than $2 \times d_1$. The same applies for the third consideration, which is that the process of twisting will elongate the gut (but reduce the total length of the resulting string), reducing in so doing the diameters d_1 of the strands, in which case, it is better to assume that the final cross-section will be less than $2 \times d_1$. However, the material (the gut) plays a major role and makes the final result more complicated, as Richard Dumbrill explains (private communication): “You must consider the nature of the gut (collagen) and depending on many factors, such as (a) the animal from which the gut comes; (b) the age of the animal when it was ‘gutted’; (c) the time between the slaughtering of the animal and when the guts were used (never longer than 30 hours); (d) were the guts salted as soon as extracted from the animal and then thor-

shall seek evidently in Kindī’s works, but first in other author’s works.

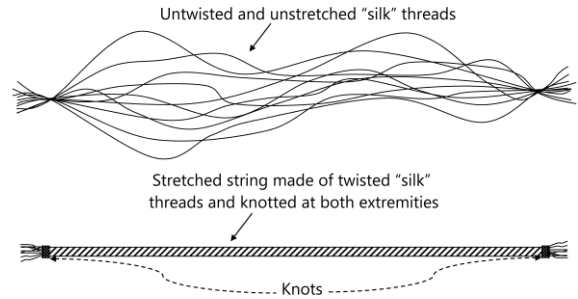

Fig. 27 Twisting and knotting of the silk threads which make the *zīr* in Kindī’s *Risāla ft-l-Luḥūn wa-n-Naḡham*. Above: bunch of untwisted and unstretched “silk” threads. Below: stretched string made of twisted silk threads and knotted at the two ends.²⁵⁷

REFERENCES TO LIGATURES (*DASĀTĪN*) IN FĀRĀBĪ’S *KITĀB AL-MŪSĪQĪ AL-KABĪR* AND (IBN) SĪNĀ’S *KITĀB A-SH-SHIFĀ’*

The *Kitāb al-Mūsīqī al-Kabīr* of Fārābī is considered to be the most complete work on Arabian music of the Golden Age of Islam.²⁵⁸ It is therefore somewhat disturbing that this author was not more quoted by Farmer with regard to “frets” on the neck of the ‘ūd; note that the *Kitāb al-Mūsīqī al-Kabīr* as well as (ibn) Sīnā’s book-chapter on music were already translated at the time Farmer wrote his article.²⁵⁹ The excerpt which was indirectly quoted by Farmer (Quote 3: 139) contains (in the

oughly washed before twisting; e) was garlic/alum used as an anti-septic prior to twisting, as this would change the structure of the collagen; f) how many twists per cm; g) what was the tension of guts during the twisting process; h) were the guts split prior to twisting. Many other factors such as hygrometry at the time of the twisting must also be taken in consideration: in practice, I would expect that the consideration of the few parameters I gave you would lead to a + or - 25% either way. The only way to set a proper formulation would be empirically to emulate ancient methods, and with proper microscopic examination”. Other considerations must be taken into account (such as the angle of the twisting, the polishing of the string) – see [Abbott and Segerman, 1976; Bonta, 1999] for more details.

²⁵⁷ Note that silk strings are not made as with gut strings. To make a silk string the silk threads must be twisted over double the length required and then folded in two (and knotted again at both ends) to make one string where the strands will not unwind. Further: “an old cloth of linen is [soaked in glue], and silk strings should be rubbed with it until they are infiltrated thoroughly with the ingredient” – in [Tsuge, 2013, p. 178]. (See also the complete description of the “making of” gut and silk strings in Appendix A.)

²⁵⁸ See for example Carra de Vaux’s appreciation of Fārābī’s work in the foreword to Erlanger’s translation of [Fārābī (al-), 1930, v. 1, p. vii].

²⁵⁹ Respectively in 1930 and 1935 – see previous footnote and [Fārābī (al-) and Sīnā (Ibn) or Avicenna (980?-1037), 1935].

original version) the phrase “these *dasātīn* play the role of bridges” that Farmer omitted, although it could have helped him defend his thesis.

Whenever this indication remains inconclusive for our purpose,²⁶⁰ other indications in Fārābī’s book may help us better understand the role of the ties for the performer:

Quote 13: “The *leimma* is close to a quarter-tone, which is the reason why its consonance may be found close to the consonance of the quarter-tone. The reason is that the finger does not always reach the exact **location** of the intended note and may [stop the string] a little further or closer. If the quarter-tone was intended and the finger went a small amount further, it becomes a *leimma* which is not originally consonant. If the interval of *leimma* was intended and [the finger] went a small amount closer, then the *leimma* becomes closer to a quarter-tone. [...] This is why it is difficult to conclude on the consonance of the *leimma* performed on the ‘ūd’.²⁶¹

While this completely contradicts Kindī’s “solid” ties (and Farmer’s assertions), the following excerpt from Fārābī’s book is even more explicit on the subject:

Quote 14: “It is however useless to multiply the *dasātīn*. Many musicians [“persons”] use other notes than these [the ones located by ligatures] which have no predetermined locations, depending on the needs of the composition of their melodies. Some of these notes are sounded from between the ligatures (*dasātīn*) and others below the ligature of the *khūnsir* [auricular]²⁶² while others [still] are found over the ligature of the *sabbāba* (index).²⁶³ These notes are used to enrich the melody. If somebody wishes to determine these notes, he must search for the corresponding **location** on the *dasātīn* or between them”.²⁶⁴

As for (ibn) Sīnā, the following explanations can be found in the book-chapter dedicated to music in his *Kitāb a-sh-Shifā’*, in the section concerning the tuning of the ‘ūd and the division of the fingerboard:

Quote 15: “Concerning the *tawṣīlāt*²⁶⁵ [pl. of *tawṣīla* – “link, connection”] – these are of the same type as the ‘mixtures’, or

²⁶⁰ Because “ligatures” can still play the role of “intermediate” bridges if they are simply marks on the fingerboards as quoted for Urmawī (Quote 9: 140).

²⁶¹ [Fārābī (al-), 1967, p. 580–583]. French translation in [Fārābī (al-), 1930, v. 1, p. 201].

²⁶² Between the ligature of the auricular and the bridge.

²⁶³ Between the ligature of the index and the nut.

²⁶⁴ [Fārābī (al-), 1967, p. 516], and [Fārābī (al-), 1930, v. 1, p. 174] for the French translation.

²⁶⁵ Otherwise called “portamentos”.

²⁶⁶ [Sīnā (Ibn) or Avicenna (980?-1037), 1956, p. 140], and [Fārābī (al-) and Sīnā (Ibn) or Avicenna (980?-1037), 1935, v. 2, p. 231] for the French translation.

close to them. They consist in plucking the string stopped at the location of one ligature and moving then the finger to another ligature located above or below it, with no disruption [on the string]. The aim is to modify the sound continuously from low to high or from high to low”.²⁶⁶

While for the two major authors of the Golden Age of Arabian music the “tie-frets” on the neck (fingerboard) of the ‘ūd are just visual markers for the notes, their explanations seem to contradict fully the indications of Kindī and Ṭaḥḥān.

As all indications in the literature and the iconography about the organology of the instrument seem to converge towards the use of fretless ‘ūd(s) in the Golden Age of the Arabian Empire, it may be concluded that either (1) Kindī did not know much about the matter (and Ṭaḥḥān copied him without experimenting with tie-frets on the neck of the instrument)²⁶⁷ or that, effectively, (2) tie-frets had existed historically over a short time period (around the 9th century) but were limited in number on the fingerboard and were used for teaching or theoretical purposes exclusively.

However, Kindī’s descriptions of the proportions of the ‘ūd and of the tie-frets being very precise in comparison to other authors, it is possible that further explorations of his and other writings may reveal other, complementary details. Eckhard Neubauer’s 1993 article on the ‘ūd is such an attempt which is typical in its Orientalist handling of the sources.

*
* *

NEUBAUER’S “BAU DER LAUTE...”

In “*Der Bau der Laute und ihre Besaitung nach arabischen, persischen und türkischen Quellen des 9. bis 15. Jahrhunderts*”,²⁶⁸ Neubauer examines the problematic of the “*Bünde*” (“frets”) on the fingerboard of the ‘ūd

²⁶⁷ Let us remind ourselves about the well-known anecdote (based on Nicomachus and) mentioned in [Chailley, 1985, p. 7–14], in the chapter entitled “The Harmonious Blacksmith”, which explains how an error stemming from a “fanciful experience [...] that five minutes and a piece of string would have been enough to rectify”, lasted 22 centuries in the musicological literature. To the like of the story of the Silesian child of Rousseau, or to the tale of the fish of King James (see the quote and corresponding footnote at the beginning of Chapter III in [Beyhom, 2016]), the desire to enhance one’s writings is often enough to lose one’s critical sense.

²⁶⁸ [Neubauer, 1993] – “The construction of the lute and its stringing according to Arabian, Persian and Turkish sources from the 9th to the 15th centuries”.

within four pages²⁶⁹ supported by various quotes in the second part of his article. He states from the outset²⁷⁰ that Farmer’s 1937 article²⁷¹ – published fifty-six years before his own article – is “clear” on this question despite of the increasing skepticism which, according to him, reached the “secondary literature”, and endeavors to “correct” the “erroneous opinion”²⁷² of authors who do not believe that Early Arabian ‘ūd(s) were fretted.

In order to support his thesis, he relies on a series of quotes, either already known to the reader – from Farmer’s 1937 aforementioned article – or “new”, from sources that he read.

Neubauer’s references to Lādhiqī, Fārābī and other authors

Neubauer’s first quote “in favour” of the fretting thesis is from Lādhiqī (the first phrase in bold type, in the original and which Neubauer leaves out, is added to explain the context)²⁷³:

Quote 16: “Some modern performers mount a sixth string on this instrument and call it the ‘ūd *akmal* [(even) “more complete” (than the “complete” ‘ūd with 5 strings)²⁷⁴], and markings are put on the neck of these instruments to show the [places] for the emission of the notes of the melodies [*madār al-alḥān*] from the neck, and these markings are called *dasātīn*, be they from tied strings, marked lines or others [still]”.²⁷⁵

This excerpt comes late in Lādhiqī’s work and complements Quote 11:140²⁷⁶, while restricted to either “modern performers” or to the ‘ūd *al-akmal*. Knowing that in the previous two pages Lādhiqī’s discourse relates to the differences between the ‘ūd *qadīm* (“the Old

‘ūd”) – with four strings – and the two others, later ‘ūd(s), and knowing that in his first indication (Quote 11) he mentions only marks on the fingerboard to be used as *dasātīn*, it is difficult, in this case, to be sure about which instrument or epoch this (new) indication (Quote 16) is.

We cannot decide either if the multiplication of the strings created specific constraints (for example for octave and fifth correspondences) which compelled some “modern performers” to add marks or ligatures (*dasātīn*) to show the new positionings for some notes, and neither can we conclude if Lādhiqī, in this excerpt (Quote 16:149) simply retells the history of the *dasātīn* by implicitly quoting Kindī – a sort of a tribute to his predecessor – on the matter. Let us simply note that, according to this quote, the *dasātīn* can either be tie-frets (made of gut or of another material) or marks (lines) drawn on the neck.

Next, Neubauer mentions *Kanz a-t-Tuḥaf*²⁷⁷:

Quote 17: “The *dasātīn* consist in a series of marks (*nešānī-ye čand*)²⁷⁸ affixed (*waḍ‘ karde*) on the necks (*sawā‘ed*)²⁷⁹ of stringed instruments (*ālāt-e dawāt-e outār*) for a firm and precise positioning (*tašaddod*) of the fingers on the string and for the production of the notes (*esteḥrāg-e naḡamāt*) on it”.²⁸⁰

In itself, this quote confirms that the *dasātīn* were marks²⁸¹ “affixed”²⁸² on the fingerboard of the ‘ūd or other stringed (and probably lute-like) instruments.

After quoting Khawārizmī at the beginning of the next page of his article,²⁸³ Neubauer, while asserting that the “usual material for the frets [was], according to Ancient sources, pieces of string”²⁸⁴ quotes then (directly) Fārābī (corresponding to Quote 3:139)²⁸⁵ and

²⁶⁹ [Neubauer, 1993, p. 328–331].

²⁷⁰ [Neubauer, 1993, p. 328].

²⁷¹ The aforementioned [Farmer, 1937], which Neubauer erroneously dates from “1939”.

²⁷² “Fehlmeinung”.

²⁷³ This is one further indication, if needed, that Neubauer picks out in the literature what comforts his thesis specifically, and discards whatever information or facts that can put it in doubt.

²⁷⁴ Expounded in [Lādhiqī (al-), 1986b, p. 178].

²⁷⁵ Translated from the Arabic version [Lādhiqī (al-), 1986b, p. 179].

²⁷⁶ “[There are] *dasātīn* in some instruments to localize the positions dedicated to the sounding of specific notes in the course of melodies” – [Lādhiqī (al-), 1986b, p. 59].

²⁷⁷ Which I could not find (and I have no knowledge of Persian).

²⁷⁸ All transliterated Persian terms in this quote are in Bold type.

²⁷⁹ “*Sawā‘ūd*” in Arabic transliteration.

²⁸⁰ Translated from [Neubauer, 1993, p. 328]: the German original quote, as for all quotes from Neubauer, is reproduced in Appendix D.

²⁸¹ “*Zeichen*” in the original German.

²⁸² “*die man auf den Hälsen [...] anzubringen pflegt*” in the original German. “*Anbringen*” can be translated as either “affixed” or “mounted” (or other possibilities), which does not help in determining the material from which these “marks” are made.

²⁸³ Translated from [Neubauer, 1993, p. 329] – Neubauer’s quote corresponds to Quote 1:138: “*dasātīn* are the tied places (*ribāṭāt*) upon which the fingers are placed”.

²⁸⁴ Which, as we have seen, is false as the majority of references provided in this dossier concern markers on the fingerboard. Note that in Neubauer’s article the only mention of “pieces of string” till this point is in Lādhiqī’s reference, which is far from being *all* the “Ancient sources”, and even further from being the “usual material” for the ties.

²⁸⁵ Translated from [Fārābī (al-), 1967, p. 498–499], in which I re-instate here [between brackets] the phrase at the beginning: “[And this instrument is one in which the notes are emitted according to

then indirectly (and with no reference to a page number):

“Elsewhere he [Fārābī] says that notes which are positioned above the ties can be played without additional ties only by Masters of the corporation [of musicians]”.²⁸⁶

Searching for this unreferenced (and indirect) quote in Fārābī’s *Great Book of Music*, the only corresponding quote to be found is the aforementioned Quote 14:148²⁸⁷ in which, however, Fārābī does not mention “Virtuoso performers” (or “Masters of the corporation”) but “many persons” who, furthermore, can play *between the ligatures, over them or below them*, a fact that Neubauer (very) lightly overlooks(!).²⁸⁸

Immediately after, Neubauer quotes Fārābī (both indirectly and directly) a second time:

“In one equivalence of fifth, the fifths can be for example only produced ‘if a fret stands there, otherwise not. Unless [the performer] succeeds in positioning the finger [correctly]’”.²⁸⁹

Here is the complete translation of the excerpt:²⁹⁰

Quote 18: “in this tuning [to the fifth between the *bamm* and the following string], the notes produced by the three strings below the first string [the *bamm*] are displaced when compared to the same notes in the usual tuning [in integral successive fourths] one whole tone above [towards the lower tones]. If a *dastān* happens to be there, they will be produced, if not they will not, or it may happen that the finger stops [the string] on the corresponding [location of the] *dastān*”.

Fārābī clearly says in the Arabic original²⁹¹ that the notes, if they are not found on one of the *dasātīn* (pl. of *dastān*) of the previous tuning, could still be performed

the division of the strings with which it is strung]. And ligatures are wound on the neck of the instrument under the strings and delineate on each of them the string-parts from which the notes are sounded, and as a result they play the role of a string-holder and are placed parallel to the bridge”.

²⁸⁶ Translated from [Neubauer, 1993, p. 329].

²⁸⁷ [Fārābī (al-), 1967, p. 516], reproduced here for convenience: “It is however useless to multiply the *dasātīn*. Many musicians [“persons”] use other notes than these [the ones already located by ligatures] depending on the needs of the composition of their melodies, which have no predetermined locations. Some of these notes are sounded from *between* the ligatures (*dasātīn*) and others below the ligature of the *khinšir* (auricular) while others [still] are found over the ligature of the *sabbāba* (index). These notes are used to enrich the melody. If somebody wishes to determine these notes, he must search for the corresponding location on the *dasātīn* or between them”.

²⁸⁸ This indirect quote by Neubauer is clearly biased in order to influence the reader in favour of his thesis as the direct quote clearly mentions performance *between* the ties, which is the most probable reason why Neubauer avoided quoting Fārābī directly.

if the finger stops the string on the corresponding position, although it may not be marked by a *dastān*.²⁹² In other terms, notes on the *ūd* that he describes can be produced whether there *are* ligatures or marks (*dasātīn*) affixed to the neck, *or not*.

Neubauer’s does not stop, however, at these truncated or tampered quotes, but quotes as well Kindī in the *Risāla fi-l-Luḥūn wa-n-Naḡham* and (ibn a-t) Ṭaḥḥān in his *Hāwī-l-Funūn wa Salwat al-Maḥzūn*.

Neubauer’s interpretation of Kindī’s *Risāla fi-l-Luḥūn wa-n-Naḡham*

Further quotes from Kindī’s *Risāla fi-l-Luḥūn wa-n-Naḡham* are provided in Neubauer’s article, explaining the tuning, and the mounting and tying of the tie-frets²⁹³, while concluding (see FHT 9:166)²⁹⁴:

“According to the indications [of Kindī] the proportions of the strings from the *zīr* to the *bamm* strings are 1:2:3:4. In an analogous way, the sizes of the frets, from the fret of the index to the tie of the auricular, should diminish in the proportion 4:3:2:1. **Both are unrealistic**”.²⁹⁵

Let us firstly note that these proportions are not necessarily unrealistic as similar increasing thicknesses of ties – but not necessarily similar dimensions – were used in European lutes²⁹⁶ and, secondly, that this quote suggests that Kindī may have given, in Neubauer’s opinion, false indications for these proportions which would in turn make him *unreliable* as regards the organology of the *ūd*.²⁹⁷

²⁸⁹ Translated from [Neubauer, 1993, p. 329].

²⁹⁰ In both Erlanger’s translation in [Fārābī (al-), 1930, v. 1, p. 208] and in the Arabic original [Fārābī (al-), 1967, p. 600]. French and Arabic texts are reproduced in Appendix D.

²⁹¹ And in the French translation.

²⁹² In any lute-type instrument a change in tuning compels the performer to adapt his technique to the new positionings of the fingers on the strings – this is common-knowledge among performers.

²⁹³ These descriptions are provided in full in “Annexe II.3” of [Beyhom, 2010b].

²⁹⁴ For “Figure Hors Texte 9, p. 166”.

²⁹⁵ Translated from [Neubauer, 1993, p. 330]: bold type mine.

²⁹⁶ [Abbott and Segerman, 1976, p. 431]: “the grading of frets for fine adjustment of the action made them remarkably thick at low positions (near the nut)”.

²⁹⁷ This supposed unreliability of Kindī is an important element in the following discussion.

However, in the second part²⁹⁸ of his article Neubauer dedicates eight full pages²⁹⁹ to Kindī’s epistle while explaining in Section 20 of his article entitled “*Die Stellung der Finger auf den Bündeln beim Greifen der Saiten*”³⁰⁰ Kindī’s description of the position of the fingers on the neck.³⁰¹

The description (see FHT 17:172) is compatible with gut tie-frets as he already described them, and the position of the finger *must not change, in either direction (nut or bridge) otherwise the sound will be muffled (Taubheit) (if the position changes towards of the bridge) or will be accompanied with “chirping[?]” (Zirpen)*³⁰² when the finger stops the strings between two ties (see FHT 18:172). Neubauer then concludes:

“[T]he description of the correct position of the fingers of the left hand still applies today and is a remarkable testimony for Kindī’s precise observation and formulation. Thus the last doubt on the practical use of frets must be here dismissed”.³⁰³

Neubauer has no more doubts here, whatsoever, about Kindī’s *reliability* for organological matters, in an assertion which totally contradicts his opinion in the previous quote about the “unrealistic” description of the proportions of Kindī’s tie-frets.

Let us note, for the record, that the whole “Section 20” is dedicated to this description, and that *all the other authors mentioning the precise stopping of the strings on the ties or that the dasātīn are marks affixed to the fingerboard of the ‘ūd are disregarded*. Let us also note that Kindī advises *against stopping the strings between the ties, and against reaching farther than (just before) the needed tie-fret in direction of the bridge*, to preserve sound quality (see FHT 16 and FHT 17:172).

²⁹⁸ Dedicated to translations of Early authors.

²⁹⁹ [Neubauer, 1993, p. 334–342].

³⁰⁰ “The position of the finger on the frets when stopping the strings”.

³⁰¹ The complete text of Section 20 [Neubauer, 1993, p. 331–332], is reproduced in Appendix D. The finger stops the string near the tie-fret, immediately behind it as shown in FHT 16:172 (2nd position – in dotted lines).

³⁰² صريرا in Arabic, which is different from “chirpen” (or the German “Zirpen”) and should be translated as “squeak”.

³⁰³ Translated from [Neubauer, 1993, p. 331–332].

³⁰⁴ I use the following three levels for quotes and sub-quotes (namely stars inside simple quotes inside double quotes): “a ‘b *c* b’ a”.

Neubauer’s interpretation of (ibn a-ṭ) Ṭaḥḥān’s *Hāwī-l-Funūn wa Salwat al-Mahzūn*

Further, in the 19th section of Neubauer’s article, in which the “frets” are explained, the author mentions the description of the tie-frets by (ibn a-ṭ-) Ṭaḥḥān (FHT 11:167) which follow similar proportions to Kindī’s (degressive from the nut).

The author concludes this section by a further quote of Ṭaḥḥān and commentary:

“... ‘There is still a fret which lies between the *ring finger*³⁰⁴ and the *auricular* frets, [but]³⁰⁵ it is also [normally] not used. This [?] are frets, which fall out of the original number [6]. They were used by the Persians for their modes. I use them **also** and reach their [correct] places [on the fingerboard], because I know them, also without [additional] frets. For students this is however difficult. **To leave them [(Sie fortzulassen)] is [therefore] better** and more appropriate (*richtiger*)’.³⁰⁶ From this follows that an Egyptian Court musician of the 5th/11th century performed also Persian music and that he played it on his local lute with or without additional frets. The fact that he avoided the additional frets and with that, the Persian repertoire for beginners is understandable.”.³⁰⁷

Neubauer’s translation above would have been accurate were it not for the terms in bold type (by me) in the quote. The “also” is added by the author in the translation, while the second expression “To leave them (the ligatures or tie-frets) is better” (in Arabic “فتركه أولى وأحق” or “to leave it”) should have been “to leave it to [or for] them is better”³⁰⁸ (in Arabic “فتركه ليم أولى وأحق”). Fig. 28:152 shows an excerpt from Ṭaḥḥān’s manuscript edited and published by Neubauer in 1990 with a frame (line below) encompassing the phrase in Arabic “فتركه ليم أولى وأحق”.

³⁰⁵ The words between brackets were added by Neubauer.

³⁰⁶ The original Arabic version from the manuscript of Ṭaḥḥān published by Neubauer [Ṭaḥḥān (ibn a-ṭ-~ al-Mūsīqī), 1990, p. 175] is reproduced in Appendix D.

³⁰⁷ Translated from [Neubauer, 1993, p. 331].

³⁰⁸ My translation converges towards Farmer’s narration of Ṭaḥḥān’s manuscript in [Farmer, 1937, p. 457], notably: “Ibn al-Ṭaḥḥān [...] tells us, however, that *he* did not need *dasātīn* on his lute because he knew the place of every note on the fingerboard without *dasātīn*. He says, further, that four rolls of gut string were required to ‘fret’ a lute, and he recommends that several thicknesses ought to be used”.

The excerpt clearly proves that Neubauer ignored the word “لهم” which means “to them”, or “for them”, excluding thus the possibility for beginners to make a choice between keeping the *dasātīn*, or performing Persian music without them.³⁰⁹ The elision of one single word by a competent philologist allows for the reversal of the meaning of the phrase, imposing thus no other choice as special tie-frets “for beginners” to perform “Foreign” music.



Fig. 28 Excerpt from f° 89 r° of the manuscript [Ṭaḥḥān (ibn al-ṭ-~ al-Mūsīqī), 1990, p. 175] reproducing lines nine and ten. The 10th line (below in the excerpt) contains the (framed) expression “فقطه لمرأى واحق” with the possessive term “لهم” meaning “to [or for] them”.

Neubauer concludes that Ṭaḥḥān “avoided the additional tie-frets and with that, the Persian repertoire for beginners”, which is contradicted by the fact that the latter simply states that he “uses” two supplementary ligatures (*dasātīn*) without “marking” or tying them on the neck, which is a clear indication that *dasātīn* did not prevent the performance *between the ligatures*.

Let us also note that, while according to Neubauer Ṭaḥḥān does not use supplementary ligatures for special notes, he would need them even less for usual, much better known to him places for the *dasātīn*.

These contradictions do not stop Neubauer from concluding:

“However, the argument that is today to hear, that it was generally not possible to play intermediate notes on a lute with frets, and that this was the reason why frets were, with time, removed is in this exclusiveness (*Ausschließlichkeit*) not accurate. Similarly, the persisting representation that frets be in the

Arabian-Islamic music history solely used for theoretical purpose[s] but not in praxis³¹⁰ must henceforth belong to the past”.³¹¹

Strangely enough, Neubauer’s argumentation is that this excerpt from Ṭaḥḥān shows that it *was* possible to play notes between the tie-frets, and he uses this possibility of playing between the “frets” as a further argument for his thesis – which is even more astonishing as, in accordance with Kindī’s explanations mentioned by Neubauer one page after, stopping the strings on a different position than the one shown in FHT 17:172 would cause the sound to become “muted” (“muffled”) and the string to sound “squeaks”.

Unless Neubauer, through his negative appreciation of Kindī’s string proportions above, considers that the “frets” were so thin that they would not hinder the performance between “frets”.

However, this would mean that these *dasātīn* did not have the role of frets, which would contradict once again his praise of Kindī’s “precise observation and formulation” of the position of the stopping finger immediately behind the (physical) tie-fret.

Whichever way we may try to understand Neubauer’s astounding statement, its inconsistency remains obvious.

Conclusions on Neubauer’s “new facts” on the fretting of the Early Arabian ‘ūd

In Neubauer’s argumentation on the “fretting” of the Arabian ‘ūd we can single-out one quote from Lādhiqī which gives alternative possibilities for the material of the ties on the neck of the ‘ūd – including simple markings – that may apply, with the latter author, restrictively to some musicians or to one particular type of ‘ūd, the “‘ūd *akmal*”. The ‘ūd *akmal* holds, according to Lādhiqī, 6 strings tuned in successive (just) fourths, a fact which complicates the identification of the stopping

³⁰⁹ Did he ignore it or forget it in his translation? In both cases, the meaning was changed *in favour* of the thesis of the fretting of the ‘ūd.

³¹⁰ The author inserts here a footnote (no. 119): “as still with Theodore Grame, *The Symbolism of the ‘ūd*, in: *Asian Music* (New York), Bd. 3,1 (1972), S. 25-34, *hier* S. 32”. Neubauer is probably reacting to the following passage [Grame, 1972, p. 32]: “As to whether the medieval ‘ūd was fretted, there has been much controversy. Most scholars, who have relied on iconographical evidence, have concluded that the lute was not fretted, for there is no known delineation of a fretted ‘ūd, though many illustrations are extant. Farmer, however, adamantly maintained that the instrument was fretted. [citation here of ‘H. Farmer, *Studies in Oriental Musical Instruments*

II, 59-68’.] He relied for this conclusion on the frequent use in the sources of the Persian word *dasātīn* [*dasātīn*] (hands; frets); further, it seems unreasonable to suppose that the lute when used for acoustical experiments would have been unfretted. Whatever may be the truth of his thesis—and it is possible to suppose that the ‘ūd, like the *viola da gamba*, was played both with and without frets—the evidence is quite incontrovertible that the present-day traditional ‘ūd is not fretted. Perhaps, as we have suggested, frets were used for investigations into the physics of sound, but were abandoned when virtuoso musicians performed”.

³¹¹ [Neubauer, 1993, p. 331].

points on the strings for the performer especially for note correspondences from one octave to another.

The persisting inconsistency in Neubauer’s arguments, who dismisses organological facts whenever they contradict his thesis, *then uses the same facts* to reinforce his thesis, is obvious in this review.

As a result, no consistent additional proof for solid tie-frets used in performance by trained musicians is provided by the author, on the contrary as we can infer from both Kindī’s and Ṭaḥḥān’s descriptions that tie-frets were used, if any, for beginners only.

Moreover, Neubauer provides solely (and mostly failed) arguments *in favour of* the “fretting” thesis and deliberately disregards the substantial, precise and even detailed arguments *against* this thesis.

Thus, Neubauer’s “New-Orientalist” approach becomes clear in its endeavor to impose forcibly the “fretting thesis” in *maqām* musicology. This, in turn, allows for the final conclusions on the “fretting” of the ‘ūd which follow.

Conclusion of Part II

TIE-FRETS, IF THEY EVER EXISTED, WERE SOLELY USED FOR BEGINNERS OR FOR THEORETICAL PURPOSES

Whenever all other authors state or explain that ligatures on the neck of the ‘ūd are equivalent to visual locators of notes used in the composition of songs and melodies,³¹² two authors, Kindī and Ṭaḥḥān describe explicitly the mounting of tie-frets on the neck of the instrument.

The principal explanation for this (monumental) discrepancy lies firstly in the nature of Kindī’s *Risāla fī-l-Luḥūn wa-n-Naḡham* which, opposed to the voluminous treatises written by Fārābī, (ibn) Sinā and Urmawī, is an epistle dedicated to the ‘ūd and to its apprenticeship.

In his introduction, Kindī explains to the reader that his aim is:

“to sketch [*rasm*] a summary of the instrument of the Wise Men fitted with four strings and called [the] ‘ūd, allowing for one to be aware of its structure and compose on it, and all that is needed to know about it”.³¹³

This epistle is then, above all, written as a method for the ‘ūd with a preliminary description of the structure of the instrument [p. 11-12], of the mounting of the tie-frets [p. 12-13], and a justification for the proportions used in this description [p. 14].

In the second part of his epistle Kindī thoroughly describes the material of which the strings are made and their specifications (homogeneity, constant cross-section, etc.), then explains the tuning of the instrument and lists the consecutive notes and their matches at the octave, with an exercise consisting in humming the successive notes while playing them on the ‘ūd.³¹⁴

He proceeds then, after a digression on the relation between the instrument and the celestial bodies, with a second exercise for which he describes note after note the fingering (tablature) to be used, with detailed indications (on three successive pages)³¹⁵ on the pace of performance and on the fingers of the right hand used to pluck each string. He concludes this part by advising the reader (the apprentice) to repeat the exercise while gradually accelerating the pace, which will help him master the instrument.

As a conclusion to his epistle Kindī explains finally that there existed at his time many schools for the performance of the ‘ūd including the Arabian, the Persian and the Byzantine [*rūmiyya*] schools, and apologizes to the reader not to be able to expound them all due to the volume of explanations this would require, and because these explanations would be understood in writing only by the “Wisest and the Most Open” of people, whilst these “arts of teaching” can be transmitted, better and faster than in a book, directly by the professional musicians (*Ahl a-ṣ-Ṣinā’a*).³¹⁶

While this epistle is clearly a method for beginners, tie-frets on the neck of the ‘ūd are also intended for them,³¹⁷ which resolves the contradiction between

³¹² Or mention the *dasātīn* without specifying the material of which they are assumed to be made of.

³¹³ [Kindī (al-), 1965, p. 9] – As a reminder, the complete text of the epistle is available in [Beyhom, 2010b, v. 1, p. 496–504].

³¹⁴ [Kindī (al-), 1965, p. 15–22].

³¹⁵ [Kindī (al-), 1965, p. 27–29].

³¹⁶ [Kindī (al-), 1965, p. 29–30].

³¹⁷ The most acute problem in the apprenticeship of fretless lutes such as the ‘ūd, the violin, etc. is the constant sounding of false notes in the first years of the apprenticeship. It is therefore totally acceptable to think about either fretting the fingerboard or marking the positions of the main notes for beginners. Knowing, however, that the technique of the ‘ūd relies on the possibility of constant modulation and interval modifications, no professional musician, were it

Kindī's (and Ṭaḥḥān's)³¹⁸ explanations and the explanations in Fārābī's *Kitāb al-Mūsīqī al-Kabīr* and (ibn) Sinā's *Kitāb a-sh-Shifā'* as well as in the later works of Urmawī, Shirwānī and Lādhiqī, as the latter described techniques and divisions which had a wider, theoretical and practical, scope.

Furthermore, with no indication in the extant literature for Kindī being a professional musician or a music teacher, he would have had the usual difficulties in identifying the correct notes to play on the fretless *ūd* (and to explain their locations to his patron), and may have experimented these tie-frets as an original way to teach how to play correctly the instrument.

Kindī's fretting and his location of pitches outside the fretting zone also become coherent as, knowing that the practical system of Arabian music was more complex than the simple Pythagorean division that he explained, he was compelled, out of intellectual honesty, to show practical ways for their sounding.

While this problematic is further examined in Appendix B about the organological particularities of the instrument, we can conclude that the use of the *dasātīn* by early theoreticians and performers amounted to materializing visual markings³¹⁹ on the fingerboard, to ensure a correct pitch for the most frequent notes on the *ūd*,³²⁰ improving the precision of the performance and of the composition. Physical tie-frets may have been used for beginners, or even with (beginner) theoreticians wishing to experiment on their own the adequacy of their descriptions – but lacking the ability to do so correctly without tie-frets.

Farmer's initial assertions about the fretting of the *ūd* are not only unjustified, but clearly wrong for most of them. To the very few sources stating the use of physical tie-frets (all in all Kindī and Ṭaḥḥān) we can oppose multiple assessments by the same, or other authors, clearly showing that the *dasātīn* in question are but –

today or in the Early days of Islam, would contend himself with one type of fretting.

³¹⁸ With both authors, tie-frets are intended for beginners, explicitly with Ṭaḥḥān and implicitly with Kindī. Note that Ṭaḥḥān has probably his source of inspiration from Kindī's – and other writers of which probably the Ikhwān a-ṣ-Ṣafā' and maybe a-ṣ-Sarākhīs – whose works are today lost but which Ṭaḥḥān copied at least indirectly from al-Ḥasan al-Kātib.

³¹⁹ Lines drawn on the fingerboard, thin threads of silk or other materials – which do not intervene in the performance as they do not help stopping the strings, but only show the positions for finger-stopping them, etc.

musically speaking – vertical markers on the fingerboard of the *ūd*.

Even the pretense to the existence of “tie-frets” for beginners is doubtful as Kindī was such an unconditional admirer of the Pythagorean “science” that he could well have invented these tie-frets for beginners (and Ṭaḥḥān would have espoused this statement), or used them for himself for learning how to play, while he and other theoreticians may have also used ligatures, made of solid material or not, to materialize the stopping points of the strings on the fingerboard of the instrument.

Adding to this that the organology of the *ūd* creates specific problems for these alleged frettings (as shown in Appendix B), no doubt remains possible about the fact that the *ūd* was never fretted for performance purposes – or that we have no indications ever mentioning such a use of tie-frets.

All in all, Sachs, Berner and Geringer were right in their opposition to the “fretting thesis”. However, biases – as with the “Byzantine Church organ”³²¹ – die hard³²² and myths will not be forgotten but are ever renewed because of the reputation of their authors, and because of the wide distribution of their works.

Researchers in musicology have generally had, notably in *maqām* musicology, a simple pattern which was the uncritical use of past research concurrently with the conscious or unconscious need to preserve these myths in order to ensure the supremacy of Western music over other musics.

It is evident that the silence of today's musicology of the *maqām* on this subject, and the perpetuation of the myth of the fretting of the *ūd* is in the interest of Western music. While this is perfectly understandable – but not acceptable – politically and socially, mere intellectual honesty compels to dismantle these myths in such a way as to avoid their further utilization.

³²⁰ As frequently observed on the marquetry of modern and contemporary *ūd*(s).

³²¹ Rosy Beyhom, in a private conversation, brings to my attention that (a-t-) Tifāshī mentions the “organ” in his 34th chapter of *Mut'at al-Asmā'*... [Tifāshī, 2019, p. 197-200] and mentions its use by the *Rūm* (Byzantines) for big ceremonies and during prayer; this should be further investigated hopefully in an upcoming publication.

³²² Since this problematic often resurfaces in discussions among (or with) musicologists, were they Western or local, influenced by Farmer's (or Manik's and, today, Neubauer's) thesis on the subject.

GENERAL CONCLUSIONS

Among all the instruments of the Arabian instrumentarium, the ‘ūd is the one which provoked the most controversy, because of its origins, its proportions, its tuning or its “fretting”, or concerning its part in Arabian music³²³ and, by extension, its influence on European music:

“Scholarship has tended to concentrate on the nature and extent of Arab musical influences on Europe, an area where paucity of evidence allows conflicting interpretations. But one thing is clear: European interest in the Arab intellectual heritage did not extend to music theory, and none of the major texts was translated. Turning to practice, however, a very different picture emerges. There is abundant lexical and iconographic evidence for the European acquisition of a wide range of instruments, the lute (‘ūd), rebec (*rabāb*) and nakers (*naqqāra*) being only the most obvious. [...] In short, although the music of the Arab courts must have provided a cultural model to be emulated, musical influences were probably not unidirectional”.³²⁴

Arabian music being the possible “missing link” between Ancient Greek music and European music, musicologists such as Farmer endeavored to prove that the Early ‘ūd was fretted, relying on a causal link between the fretting of the instrument and the establishment of its “Pythagorean temperament” which would have been then transmitted, through multiple contacts in Southern France and Spain,³²⁵ to Europe and justifying thus the use of ditonism – if not of harmony with Farmer – in their music.

As has been shown in this dossier, neither the fretting of the ‘ūd nor the Pythagorean division of Kindī and other Early philosophers apply for performance practice. Tie-frets *may* have been used for beginners (Kindī, Ṭaḥḥān), or for theoretical purposes. The Pythagorean division was inherited from the Greeks, and was the only template the Arabs had to test their Early theoretical representations in string-length ratios. Kindī, the first Arabian theoretician on music whose writings are extant, describes however “notes performed by singers” which testify that, already in the Early phases of the Arabian Civilization, praxis departed from this simplistic model.

³²³ All these topics are explored in the “Annexes” of [Beyhom, 2010b], namely and respectively in appendices II.5 and II.6, appendix II.4 and appendix II.2.B.

³²⁴ [Wright, Poché, and Shiloah, 2001, p. 805 (Arab music, §I, 3, IV)].

Further descriptions by Fārābī and (ibn) Sinā, the two greatest theoreticians of the Golden Age of this civilization, confirm the Zalzalian model which is still in use today, and for which the ‘ūd, with its melodic versatility and multiplicity of techniques, is (still) a perfect receptacle as well as an inspiring theoretical tool for this music.

Such writers as Farmer and his gigantic ‘ūd(s) which would have been described by Kindī and Ṭaḥḥān³²⁶ received no criticism for decades. This seems to be commonplace with the musicology of *maqām* music (including Byzantine chant), probably because for these musics what is said is less important than the moral authority of researchers in this domain, as Neubauer in the article reviewed in Part II of this dossier.

Evidently other, ideological and societal factors interfere with the needs of “science” which, in musicology, seems to be an overrated characteristic.

As stated by my illustrious predecessor Abū-n-Naṣr Muḥammad ibn Muḥammad ibn Tarkhān ibn Uzlagh al-Fārābī:

“To be an accomplished theoretician, whatever science is involved, there are three conditions:

- To know all the principles of the given science.
- To have the capacity to deduce the necessary consequences of these principles in the *beings* (the data) which belong to this science.
- To know how to answer erroneous theories and analyze what is true from what is false and correct the errors”.³²⁷

I would add: knowing that (one of) the burden(s) for the future generations of scientists will be to correct our errors today.

*
* *

³²⁵ Notwithstanding the Byzantine influence on the Eastern – while often changing – border, and its interaction with Arabian influence.

³²⁶ See [Beyhom, 2011 ; Bouterse, 1979].

³²⁷ Translated from [Fārābī (al-), 1930, v. 1, p. 2].

APPENDIX A: THE ‘*ūd*, ITS COMPONENTS AND ITS PROPORTIONS³²⁸

I have explained elsewhere³²⁹ that most, if not all,³³⁰ Early Islamic speculations on music theory used the ‘*ūd* as the main vector for their explanations. In turn, as inheritors of the Greek tradition through the translation enterprise set by Caliph al-Manṣūr in the 9th century, Arabian philosophers and theoreticians adapted Greek theories for this instrument (notably used as a “poly-chord” – as compared to a “monochord” – with strings tuned in successive fourths), which became thus the main vector for the *maqām genos* – and mode – theory.

First detailed descriptions of the ‘*ūd* by Kindī

The first known complete description of the ‘*ūd* and its construction is found in the epistle *Risāla fi-l-Luḥūn wa-n-Nagham* by 9th-century “Philosopher of the Arabs” Ya‘qūb ibn Ishāq al-Kindī.³³¹ Kindī’s description says (FHT 2:158):

“[and the] length [of the ‘*ūd*] will be: thirty-six joint fingers – with good thick [‘full’] fingers³³² – and the total will amount to three *ashbār*.³³³ And its width: fifteen fingers. And its depth seven and a half fingers. And the measurement of the width of the bridge with the remainder behind: six fingers. Remains the length of the strings: thirty fingers and on these strings take place the division and the partition, because it is the sounding [or ‘the speaking’] length. This is why the width must be [of] fifteen fingers as it is the half of this length. Similarly for the depth, seven fingers and a half and this is the half of the width and the quarter of the length [of the strings]. And the neck must be one third of the length [of the speaking strings] and it is: ten fingers. Remains the vibrating body: twenty fingers. And that the back (sound box) be well rounded and its ‘thinning’ (*khart*) [must be done] towards the neck, as if it had been a round body drawn with a compass which was cut in two in order to extract two ‘*ūd*(s)”.³³⁴

³²⁸ This appendix relies on [Beyhom, 2011].

³²⁹ In [Beyhom, 2016].

³³⁰ Very few theoretical descriptions were, in Early Islam (the civilization), undertaken using the neck of the *tunbūr*, mostly for music of particular areas and periods – see the appendix on the ‘*ūd* and the *tunbūr* in [Beyhom, 2010b] and the “First Interlude” in the main text of this dossier.

³³¹ “Abū Yūsuf Ya‘qūb ibn Ishāq Al-Kindī (ca. 800–870 CE) was the first self-identified philosopher in the Arabic tradition. He worked with a group of translators who rendered works of Aristotle, the Neoplatonists, and Greek mathematicians and scientists into Arabic. Al-Kindī’s own treatises, many of them epistles addressed to

Kindī adds complementary information further below in his text:

“Then they adopted (*sayyarū*) the ratio which is after the third [of the length of the strings] – and it is the half – for the width and it is the largest width it must be, and its position on the ‘*ūd* must be three fingers away from the end of the bridge in the direction of the [‘following the’ – *ilā mā yalī al-*] strings [width of the bridge = $3 - 7.5 + 6 = 1.5$ fingers], and the reason for this [is] that it is placed along [*bi-muḥādihāt* = at the proximity of] the place where the strings are plucked, and this because this emplacement [on the ‘*ūd*] is the widest and the most perfectly sounding. With regard the plucking of the strings, it is at three fingers from the [front of the] bridge [$6 + 3 = 9$ fingers from the bottom] because it is the position of one of the parts of the strings and it is its tenth”.³³⁵

To summarize, Kindī’s proportions for the ‘*ūd* in this epistle are (FHT 2) as follows (fractions are given in relation to the total length *L*, the unit is “ff” (or “full fingers”)):

- Total length: $36 \text{ ff} = L$
- Total width: $15 \text{ ff} = 10L/24 = 5L/12$
- Total depth: $7.5 \text{ ff} = 5L/24$
- Length: $10 \text{ ff} = 5L/18$
- Soundbox length: $26 \text{ ff} = 13L/18$
- Position of the bridge: 6 ff from the lower end = $4L/24 = L/6$
- Total speaking length: $30 \text{ ff} = 20L/24 = 5L/6$
- Speaking length above soundboard: $20 \text{ ff} = 5L/9$
- Optimal plucking point (from the lower end): $9 \text{ ff} = L/4$
- Soundbox: width/length = $15/26$, or around $3/5$; depth/width = $1/2$

Note, however, that the proportions of the total depth to the total width, then to the total speaking length is 1:2:3, or the two first tetradic ratios based on the first three elements of the *tetrad*.

members of the caliphal family, depended heavily on these translations” – in [Adamson, 2011]. More information on Kindī is provided in the main text.

³³² (Reminder:) Literally “full fingers with good flesh”.

³³³ The *shibr* (singular of *ashbār*, “span” in English) is a measurement unit which equals roughly 20 cm. It equates to the length between the tip of the thumb and the tip of the auricular finger when stretched flat and in opposite directions. The *shibr* otherwise measures 12 fingers (which equates to 36:3 in Kindī’s description): a “full” finger should be about 2 cm in width.

³³⁴ Translated from the original Arabic [Kindī (al-), 1965, p. 11].

³³⁵ Translated from the original Arabic [Kindī (al-), 1965, p. 15].

Description of the “Modern” ‘ūd by Ṭaḥḥān

Whenever Kindī’s ‘ūd appears to be a monoxyle lute-type instrument,³³⁶ the first extant detailed description of the “modern” ‘ūd³³⁷ is Abū-l-Ḥasan ibn a-ṭ-Ṭaḥḥān’s (11th century).³³⁸

“The dimensions of the lute should be as follows [see FHT 3:159]: its length should be 40 *aṣābi*;³³⁹ *maḍmūma*.³⁴⁰ Its width should be 16 *aṣābi*; *maḍmūma*. Its depth should be 12 *aṣābi*; *maḍmūma*. The bridge should be placed at about 2 *aṣābi*; [“*iṣba‘ayn*” – the flexion of *iṣba‘* for the dual case] odd from the bottom. The neck should be 1 *shibr* + 1 ‘*aqd*’³⁴¹ in length. The pegs should be eight unless there is a *zīr ḥād* string³⁴² when there will be ten strings,³⁴³ but this is not known in our times.”³⁴⁴

If we compare the proportions of Ṭaḥḥān’s ‘ūd to Kindī’s, we note that the ratio (Total) depth/width/speaking length of the string is no more 1:2:3 but (FHT 3:159) 12:16:38, which is equivalent to 3:4:8, slightly further from the “ideal” Pythagorean proportions.

This also applies to modern ‘ūd(s) with proportions shown on FHT 4:160 to FHT 8:164 namely:

- The ‘ūd described by Khulā‘ī (beginning of the 20th century – FHT 4:160 and FHT 5:161),
- the ‘ūd of the well-known Munir Bashīr (2nd half of the 20th century – FHT 6:162),

³³⁶ And most probably a forerunner of the *barbaṭ*.

³³⁷ In Ṭaḥḥān’s description of the ‘ūd, as in the modern instrument and unlike Kindī’s description, the back (or the shell) is assembled from thin strips (ribs) of hardwood, joined (with glue) edge to edge to form a deep rounded body, and is at a later stage of its construction joined to the monoxyle neck.

³³⁸ Ṭaḥḥān was a musician of high repute during the Egyptian Fatimid Period, who died sometime after 1057. He was mainly a singer and an instrumentalist, and is with Kindī one of the very few having described the ‘ūd and its facture. His work entitled *Ḥāwī al-Funūn wa Salwat al-Maḥzūn* is in two parts, the second of which being about praxis.

³³⁹ Plural of *iṣba‘*, Arabic for “finger”.

³⁴⁰ The verb *ḍammā* means “to join”, *maḍmūm*, or *munḍamm* meaning “joined” or “tightened”. Farmer’s notable error was the confusion between “joined” and “doubled”, which made him double the sizes of the ‘ūd(s) he described in his “The structure of the Arabian and Persian lute in the Middle Ages” [Farmer, 1939b]. (This is detailed in [Beyhom, 2011].)

³⁴¹ The ‘*aqd*’ is a particular Arabian value which in context equates to a “unit” (1) or to “ten” (10): in this context it is equivalent to “10 joined fingers”.

³⁴² The (theoretical) 5th string of the ‘ūd, the *zīr ḥād* (or simply *ḥād* – “sharp” – or “2nd *zīr*” for some authors) is already cited by Kindī in his *Kitāb al-Muṣawwītāt al-Watariyya min dhāt al-Watar al-Wāhid ilā dhāt al-‘Ashr[at] Awtār* [Kindī (al-), 1962b, p. 78]. As a reminder: the

- the two *Biṭār* ‘ūd(s) made by the Lebanese luthier for, respectively, Saad Saab (FHT 8:164) and Amine Beyhom (FHT 7:163) (the latter being an electro-acoustic instrument).

Such “modern” instruments may have even more “inharmonic” proportions as Ṭaḥḥān’s, with a resulting quality of sound³⁴⁵ which is probably different, but not necessarily less pleasant than with (Pythagorean influenced) ‘ūd(s) with “harmonic” proportions. I show elsewhere³⁴⁶ that this evolution from the purely theoretical application of Pythagorean mathematics to more practice-oriented methods and proportions applies also to Arabian music theory.³⁴⁷



FHT 1 “Padauk/Walnut Body with Cedar top [‘ūd with] Amazing wood in wood inlay (Maker: Farouk Shehata, 1993)”.³⁴⁸

first four strings were called (from the lowest to the highest – acoustically and conventionally) the *bamm*, the *mathlath*, the *mathnā* and the *zīr*. Whenever today’s ‘ūd(s) incorporate six (or seven) (double – except generally for the lowest, acoustically) courses of strings (FHT 5:161 and FHT 7:163), it seems that, in Fatimid Egypt at the time of Ṭaḥḥān, this fifth string was still not in use, or came to be in disuse, which may seem less likely but is possible; note that iconographic sources show five strings as early as the 10th-11th centuries – see [Beyhom, 2010b, v. 1, p. 92] and [Farmer, 1966b, p. 49], the latter showing six courses. The need for the *ḥād* string was mostly theoretical in the time period of the Forerunners (see footnote 45:119 for time periods for Arabian music theory), to complete the double-octave. We find a mention of five courses of strings in the practice of the instrument in Urmawī’s epistle *A-ṭ-Risāla a-sh-Sharafyya* [Urmawī (d. 1294) and [Jurjānī (al-), 1938, v. 3, p. 110] (reedited as [Urmawī (d. 1294) and [Jurjānī (al-), 2001]), in the 13th century.

³⁴³ In fact, five courses with two identical strings each.

³⁴⁴ [Ṭaḥḥān (ibn a-ṭ- al-Mūsīqī), 1990, p. 172].

³⁴⁵ The tone-color (or timbre) for example, although this characteristic of sound depends on other, organological and environmental factors as well.

³⁴⁶ Mainly in [Beyhom, 2010b], and partly in this dossier.

³⁴⁷ See also [Hilarian, 2005] for a comparative study of the Malay-Lutes (*Gambus*) with the Arabian lutes, which gives an insight into the variety of shapes of short-necked lutes together with [Hellwig, 1974] (for Western lutes).

³⁴⁸ Retrieved 20/10/15 from <http://www.mikeouds.com/oudpics.php>.

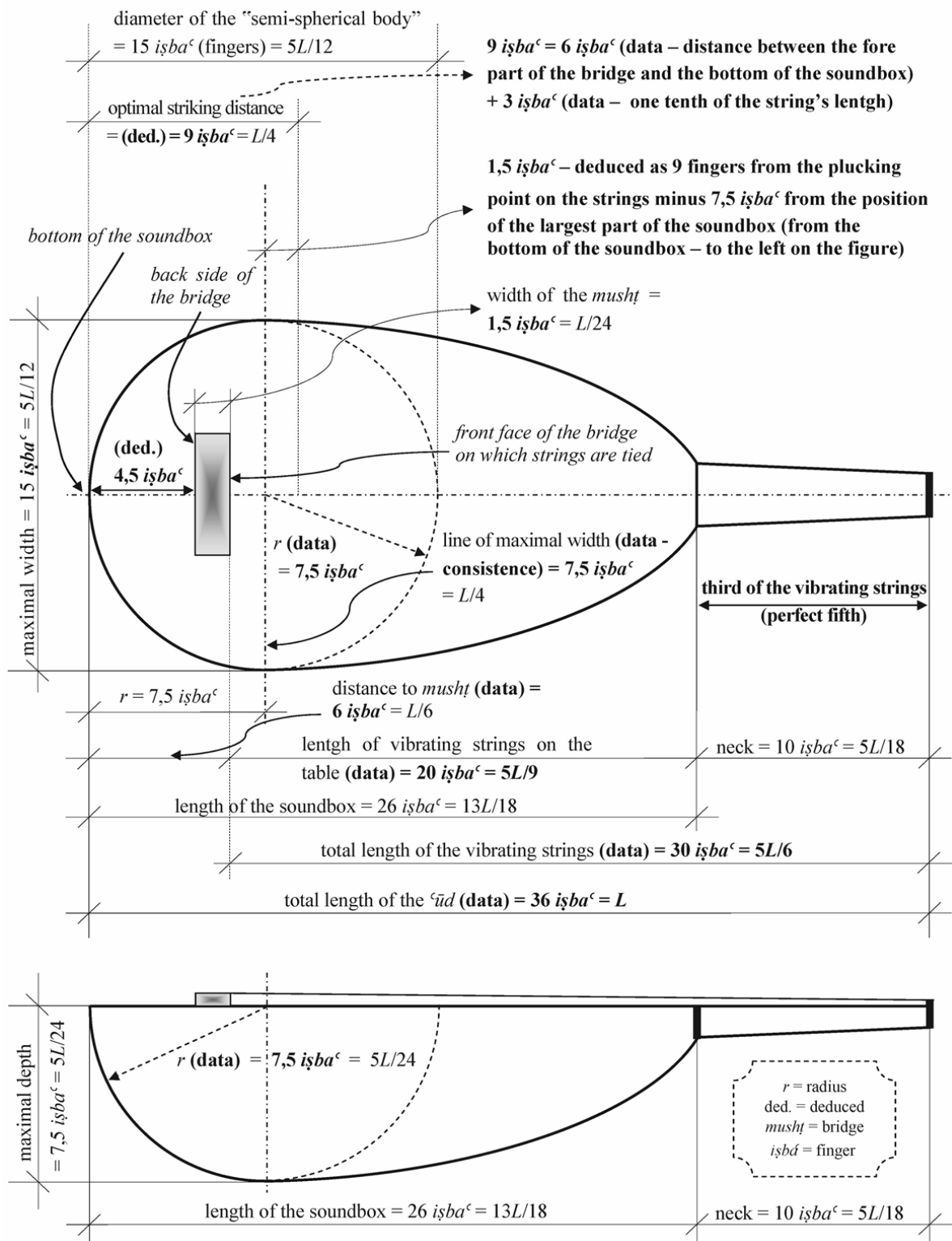

FHT 2 (Al-) Kindī's description of the *ʿūd*, in "full finger (*iṣbaʿ* – pl. *aṣābiʿ*) thickness" measurements, and deduced (calculated) proportions.³⁴⁹ The same procedure is used for the "Harmonic division" shown on Fig. 9:131. ("Vibrating string" = speaking length of the string.)

³⁴⁹ First published in [Beyhom, 2011].

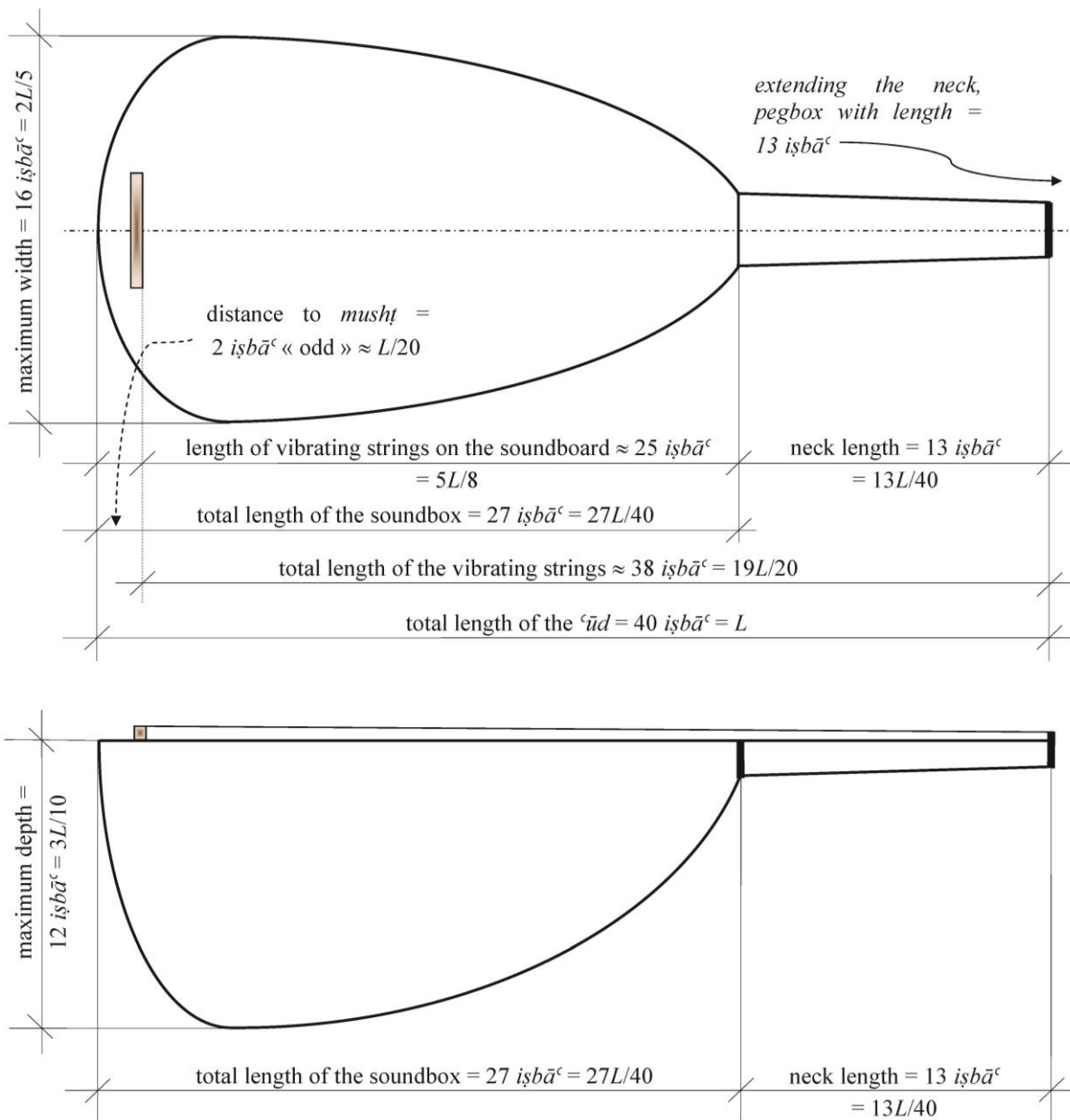

FHT 3 Drawing of the ‘ūd described by Ṭaḥḥān.³⁵⁰ (Reminder: “The dimensions [...] should be as follows: its length should be 40 *aṣābi*;³⁵¹ *maḍmūma*. Its width should be 16 *aṣābi*’ *maḍmūma*. Its depth should be 12 *aṣābi*’ *maḍmūma*. The bridge should be placed at about 2 *aṣābi*’ odd from the bottom. The neck should be 1 *shibr* + 1 *‘aqd* in length. The pegs should be eight unless there is a *zīr ḥād* [double] string and ten strings [in all], but this is not known in our times.” Note also that “vibrating string” = speaking length of the string.)

³⁵⁰ First published in [Beyhom, 2011].

³⁵¹ Arabic grammar is complicated: the plural for more than 10 *aṣābi*’ (or anything or anyone) is like the singular form, *iṣbā*’. Hence: 40 *iṣbā*’, 16 *iṣbā*’, 12 *iṣbā*’, etc., but also *imra’a* (a – or one – woman), *imra’atayn* (two women), three (to ten) *nisā*’ and 11 (and more) *imra’a!*

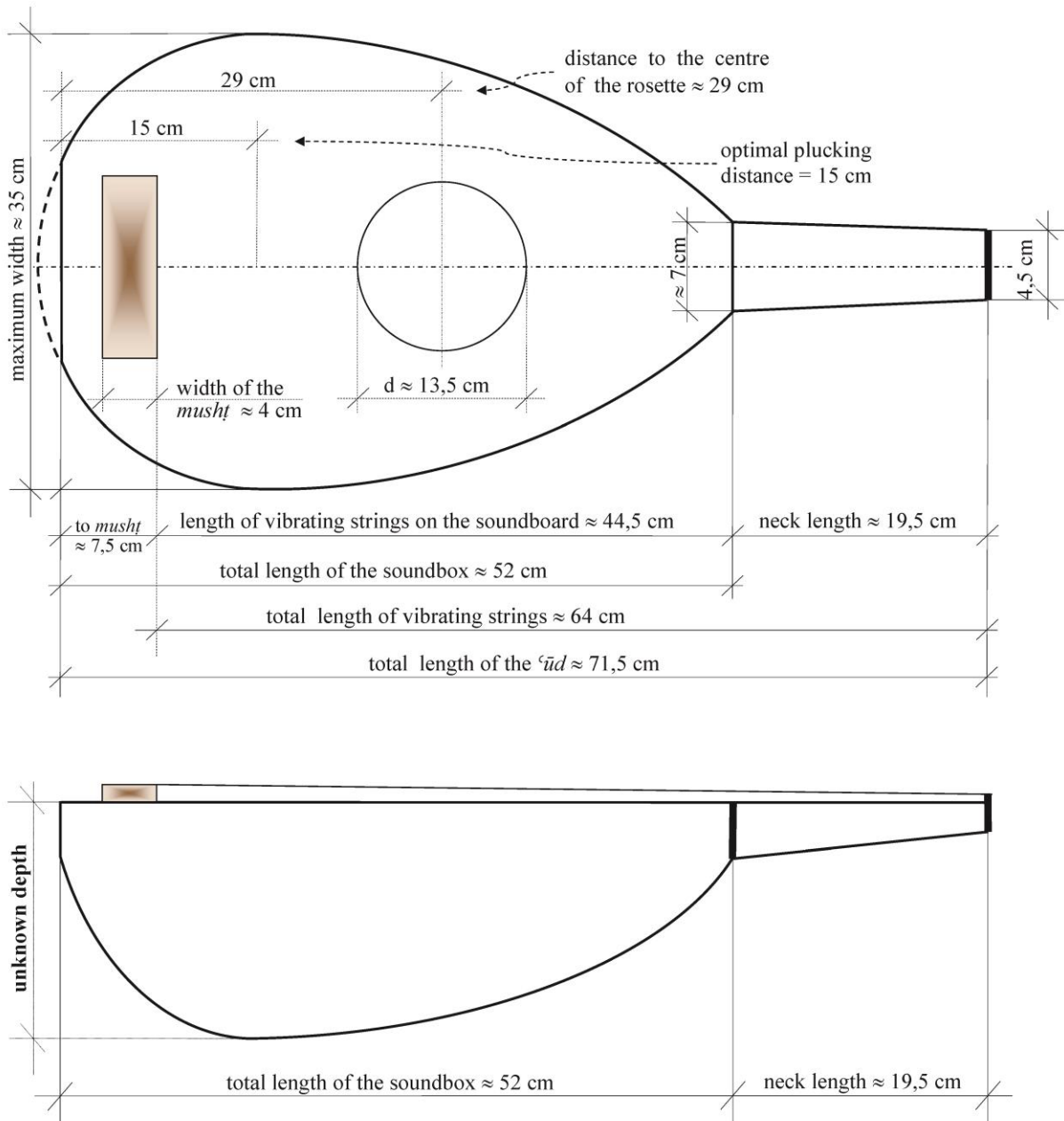

FHT 4 Revision of the 'ūd described by Khula'ī in his *Book of Oriental Music* [Khula'ī (al-), 1904]. The measurements are those taken from the original drawing (next figure).³⁵² ("Vibrating string" = speaking length of the string.)

³⁵² First published in [Beyhom, 2011].

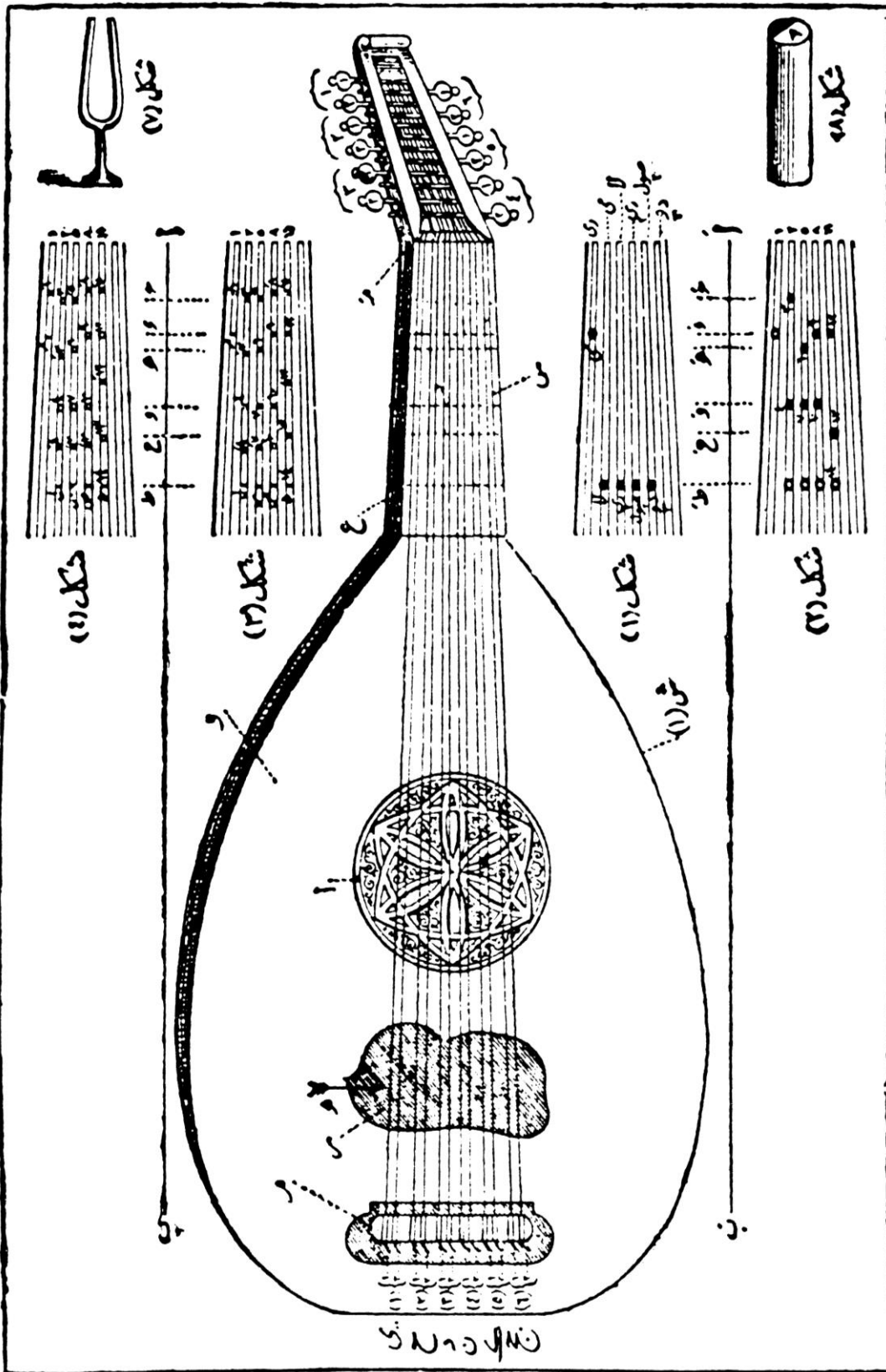

FHT 5 Depiction of a 'ūd in [Khula'ī (al-), 1904, p. 52].

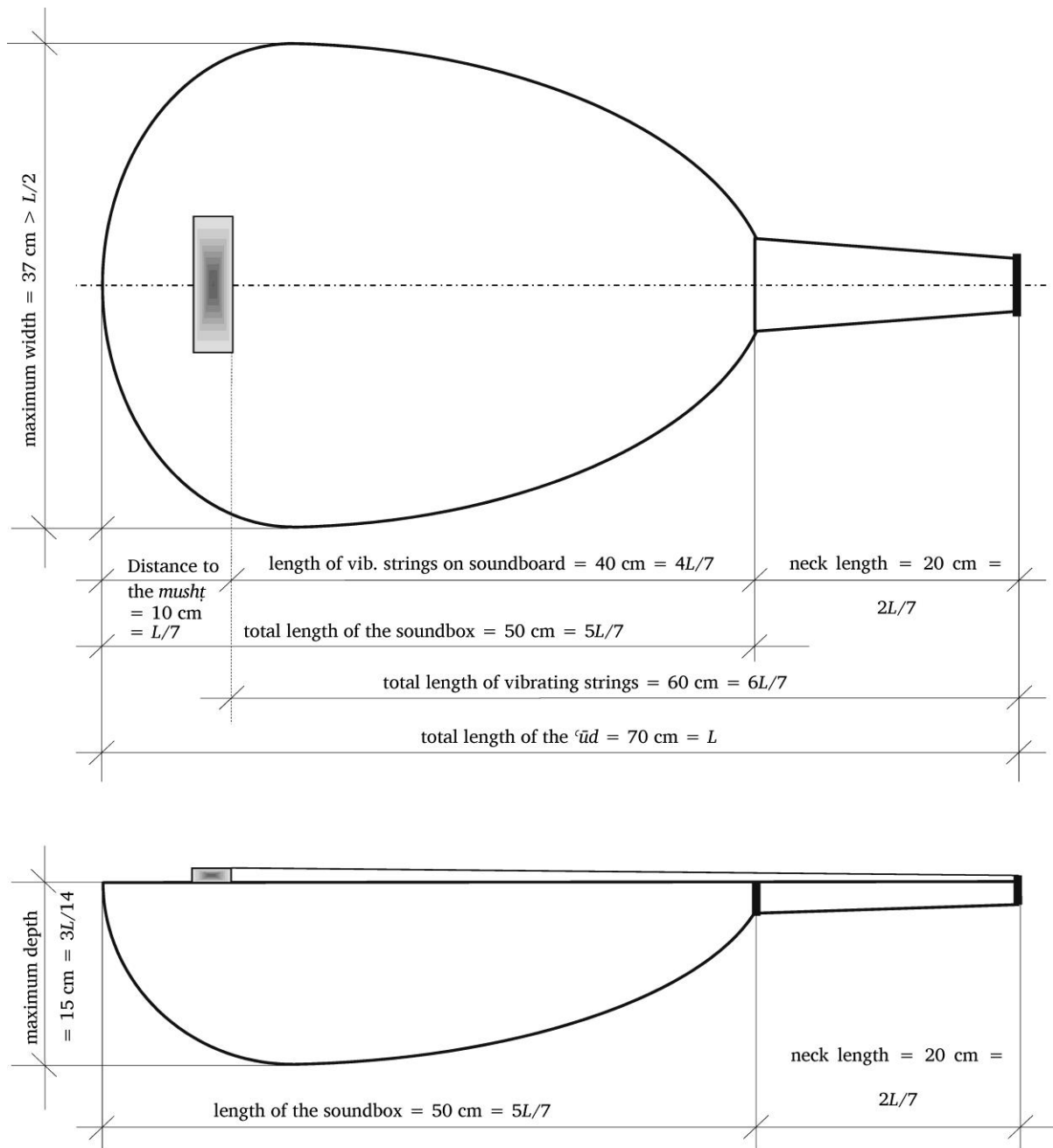

FHT 6 Drawing of the 'ūd of Munir Bashir (1957 – described in [Rashid, 1999]). (“Vibrating string” = speaking length of the string.)



FHT 7 Front and side views of the *Biṭār 2001* electro-acoustic ‘ūd with thin soundbox, engineered and re-designed by the author and crafted by Lebanese *luthier* [string instrument maker] Georges Biṭār in 2001. This instrument is a straightforward adaptation of the physical elements of which the *Biṭār-Saab* ‘ūd (FHT 8) is made. No Pythagorean proportions can be seen were it for this instrument or for Khulaṭī’s in FHT 4 and for Bashīr’s in FHT 6.

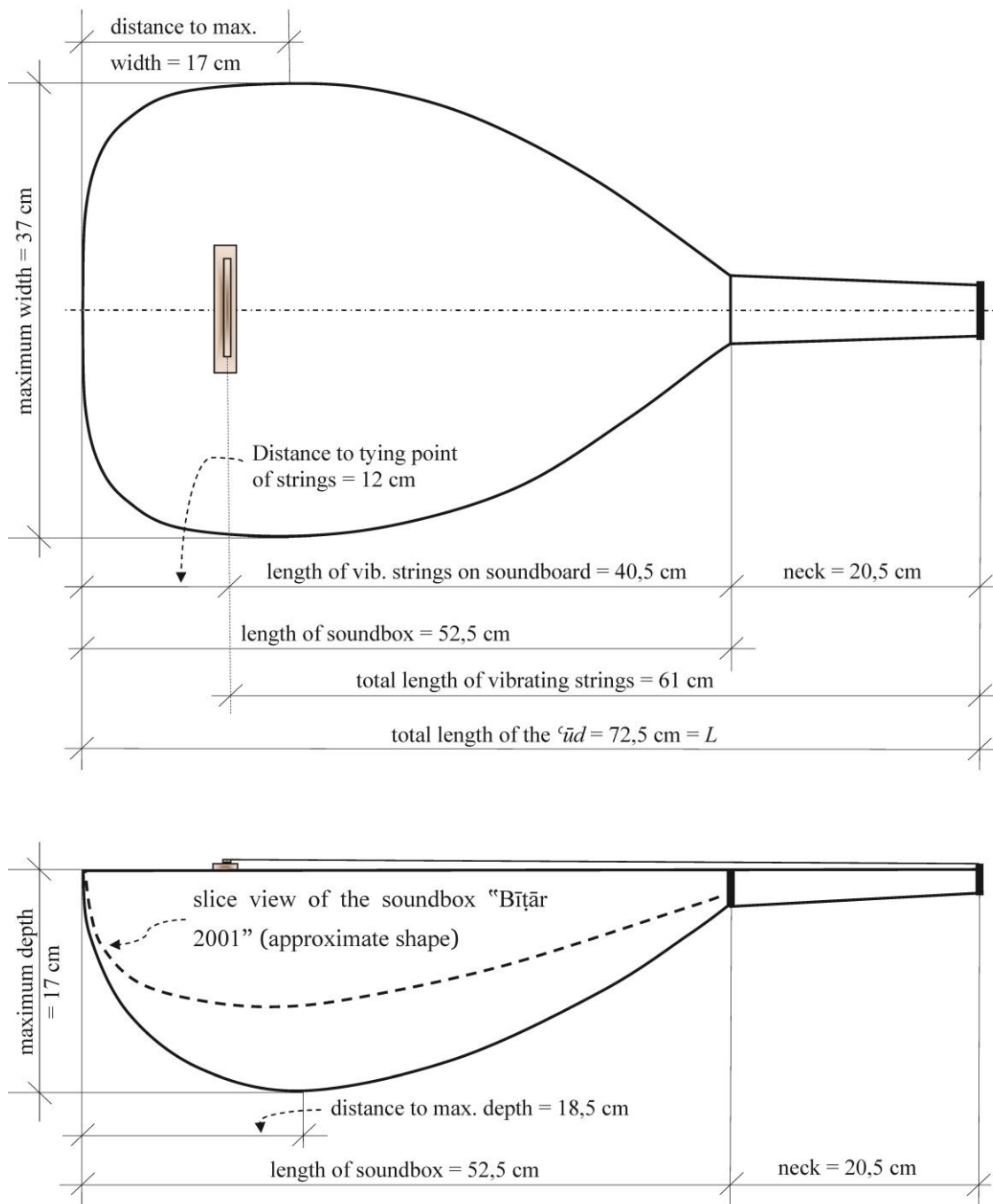

FHT 8 Drawing of the *Biṭār-Saab ʿūd*. The original instrument was made by the Lebanese *luthier* Georges Biṭār in 2001-2002 following the specifications of *ʿūd* teacher Saad Saab for teaching purposes at the Lebanese National Conservatory. The transverse-slice view is from the electro-acoustic *Biṭār 2001 ʿūd* shown in FHT 7.

About the strings of the ‘ūd and their proportions

The strings of musical instruments – including the ‘ūd – were usually made of gut or of threads of silk, according to extant writings, and with degressive proportions from the *bamm* – the lowest acoustically – to the *zīr* – the highest acoustically. One of the most complete descriptions of the “making of” gut or silk strings is written in the well-known *Kanz a-t-Tuḥaf*, the 14th-Century Persian treatise (“epistle”) on music, here translated by Tsuge:

“Chapter Five: concerning the twisting (*fatl*) of the silk strings (*abrišāmin*) – Distortion and straightforwardness in sound (*āvāz*) depends on goodness and poorness in quality of the strings. Strings of musical instruments may be twisted either from silk (*abrišan*) or gut (*amīā*) of sheep, which are indispensable. For the sake of silk strings, raw silk should be prepared. The cocoon for silk reeling must be white, smooth, and even in terms of size and quality, and round (*mostadīr*). [Raw silk] should be polished (*pardākte*), well spun (*kūb rešte*) from the cocoon, which must be boiled in water mixed with ash (*qalye*). After that, being taken out, it should be washed in pure water two or three times, and hung up to dry in the shade. When it is spun, however, it should be exposed to the sun. The following conditions should be fulfilled in the making of silk strings. When a *bam* string is spun it should be made from 64 threads of silk, a *maṭlaṭ* string should be from 48 threads, and a *maṭnā* string should be from 32 threads, a *zīr* string should be from 24 threads, and a *ḥād* string should be spun from 16 threads. And silk strings should be gently spun. After that, glue (*serīšom*) should be boiled and mixed with a small amount of saffron (*za’farān*). On the condition that its density and viscosity is moderate, an old cloth of linen is [soaked in it], and silk strings should be rubbed with it until they are infiltrated thoroughly with the ingredient. And then they are released and left until they are dried.

Chapter Six: concerning the twisting of the gut strings (*me’āī*) – The wise are agreed that bass strings should be spun from sheep gut. Because its components are rarefied (*takākolī*), the bass strings are called ‘mother of the strings’ (*omm-ol-owtār*), too. In terms of the kinds of gut, that of the ewe (*mīšīne*) is considered better than that of the ram (*bozīne*). Some people might say that gut of the white ewe (*mīšīne-ye sefid*) is better than [that of] the black ewe, but this notion (*ma’ānā*) is exaggerated. In order to make the bass strings, one should prepare guts that are even throughout in terms of thinness and thickness. The gut should be soaked in poppy juice (*šīrābe*) all night, and should be spun the following day. For the sake of proper

spinning, one must watch carefully. If the gut is thin, three-ply should be twisted together for the *bam*; however, if the gut is thick, two-ply will suffice. Some people may spin the *maṭlaṭ* string also from gut, on the condition that the *maṭlaṭ* string is thinner than the *bam* string by single-ply. After that, an old cloth of linen [soaked in] whitewash (*sefidāb*) with saffron dissolved, and [one] should rub the gut strings several times strongly [with it]. And then the strings are released and left until they are dried.”³⁵³

If we apply the gradation given by the epistle to the strings made of silk strands, *i.e.* (18)³⁵⁴, 24, 32, 48 and 64, we can easily calculate the corresponding sections and diameters of the strings in relation with the section or diameter of the smallest string, that we name respectively s_1 and d_1 . (Or, simply, s and d as shown in THT 1.³⁵⁵)

Number of threads	64	48	32	24
Division by 8	8	6	4	3
Section	8/3 s	6/3 s	4/3 s	3/3 s
Diameter = 2 x $\sqrt{s/(\pi)}$	11/6 s	8/5 s	4/3 s	9/8 s
Diameter (2)	1 5/6	1 3/5	1 1/3	1 1/8

THT 1 Theoretical sections and diameters of the silk strings in *Kanz a-t-Tuḥaf*. (Not including the thinnest string – the *ḥād*.)

Hence, the section of the threads being equal, theoretically and as shown in Fig. 26:147 for strings made of gut and explained in the corresponding footnote, to the sum of the sections of the silk threads (or guts) of which each string is made, the relation between the diameter d (or its half, the radius r) and the section s of a string is (FHT 12:167):

$$s = \pi r^2 = \pi \frac{d^2}{4}, \text{ with } d = 2 \times \sqrt{\frac{s}{\pi}}.$$

Proportions for the strings of the ‘ūd were also given by Kindī (FHT 9:166), the Ikhwān A-ṣ-Ṣafā’ (“The Brethren of Purity” – FHT 10:166), and (ibn a-t-) Ṭaḥḥān (FHT 11:167), with the latter proposing further proportions by “weight”.

Finally, let’s note that gut strings are very sensitive to hygrometry; in a dry climate, gut tends to become (or remain) well stretched while in Northern Europe, as an opposite example, gut strings (and tie-frets) tend to lose their tension.³⁵⁶ This fact alone pleads for caution when stringing and “fretting” the instrument.

³⁵³ [Tsuge, 2013, p. 178]: See also the interesting comparison established in [Leoni, 1996].

³⁵⁴ We shall not include the last – and thinnest – string (the *ḥād*) in this review, as the other reviewed authors give the proportions for the four strings from *bamm* to *zīr* exclusively.

³⁵⁵ “THT. 1” = “Tableau Hors Texte 1” or “table outside the main text”.

³⁵⁶ Jean During told me (private communication) that more often, the gut tie-frets of his long necked lutes which have been tightened in Iran lost their tension (due to the higher hygrometry) in France, and became so loose as to prevent from playing the instruments. In some cases, once the instrument was brought back to Iran, the tie-frets tightened again.

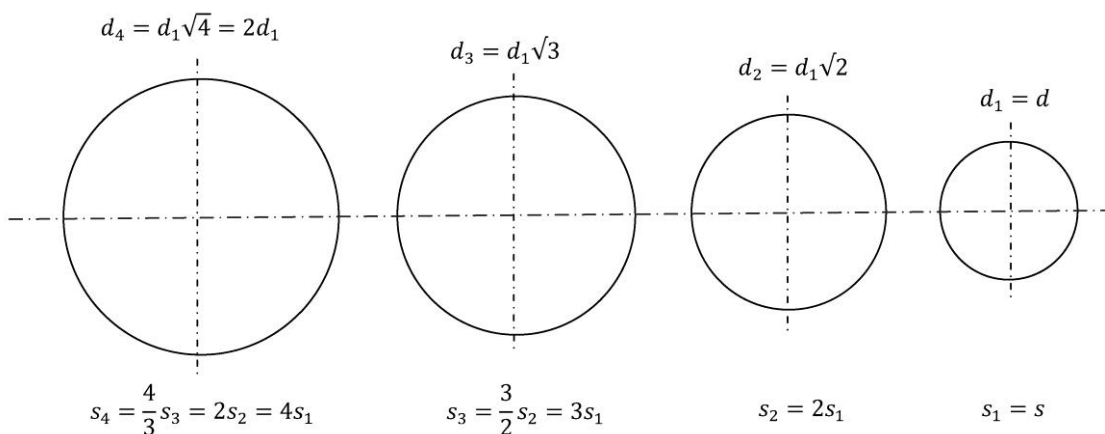

FHT 9 Proportions of the strings of the ‘ūd according to Kindī in the *Risāla fī-l-Luḥūn wa-n-Naḡham*³⁵⁷: s_1 to s_4 are the cross-sections, d_1 to d_4 are the diameters of the strings from *zīr* to *bamm*. The proportions of the sections from *zīr* (right) to *bamm* (left) stand as 1:2:3:4. The intermediate strings are called the *mathlath* (s_3) and the *mathnā* (s_2).³⁵⁸

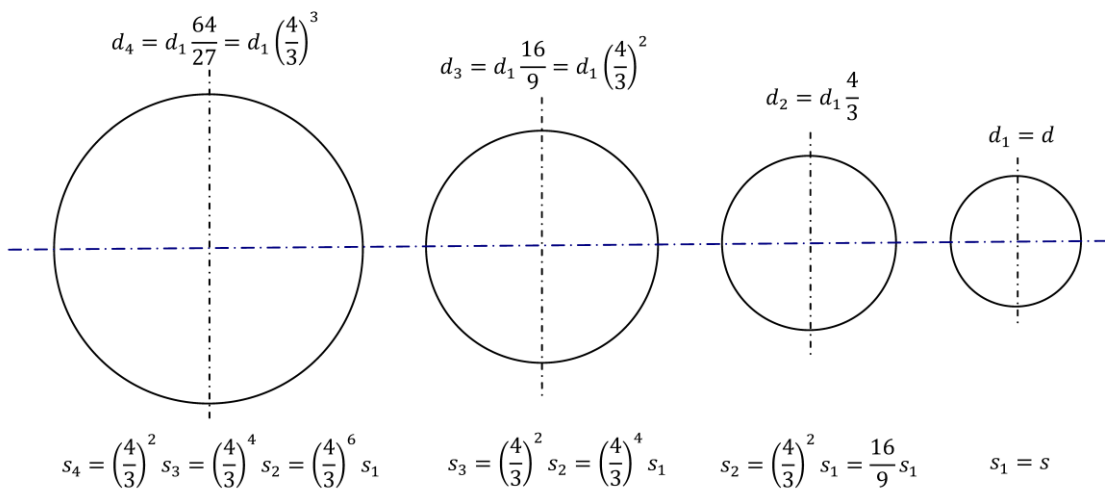

FHT 10 Proportions of the strings of the ‘ūd according to Ikhwān a-ṣ-Ṣafā’ in their Fifth epistle (“On Music”)³⁵⁹: s_1 to s_4 are the cross-sections, d_1 to d_4 are the diameters of the strings from *zīr* to *bamm*. (See figure above for the names of the strings.)³⁶⁰

³⁵⁷ Originally published in [Beyhom and Makhlouf, 2009].

³⁵⁸ Following the hypothesis that the diameters of the twisted strands of guts remain unchanged after the twisting – see Fig. 26:147 and corresponding footnote.

³⁵⁹ See [الصفاء, S.D.] or [Dieterici, إخوان الصفاء, and Iḥwān al-Ṣafā’, 1865, p. 117–118]; for the Ikhwān note [Wright, 2001h]: “A 10th-century group of Islamic encyclopedists of Ismaili tendencies centred on Baṣra, one of whose epistles (*Rasā’il*) deals with music. Unlike most other music theorists of the 10th and 11th centuries, the Ikhwān al-Ṣafā’ were chiefly concerned with the neo-Platonic and Hermetic aspects of the Greek heritage. Their work is of some interest for its scientific aspects (in particular the theory of the spherical propagation of sound) and for its treatment of musical practice: for example, following al-Kindī, the discussion of the lute gives, in addition to a (simple Pythagorean) fretting, details of proportions and construction. But the most characteristic features of their work, again following al-Kindī, are to be found in their study of cosmology, where the notion of cosmic harmony (based on the Pythagorean concept of the primacy of number and numerical relationships) is the unifying principle in the discussion of such topics as the music of the spheres, the moral and medical effects of music, and the sets of natural phenomena (including the elements, winds, humours, colours and perfumes) to which the rhythms and the four strings of the lute could be related.”

³⁶⁰ Following the hypothesis that the diameters of the twisted strands of guts (or silk) remain unchanged after the twisting – see Fig. 26:147 and corresponding footnote.

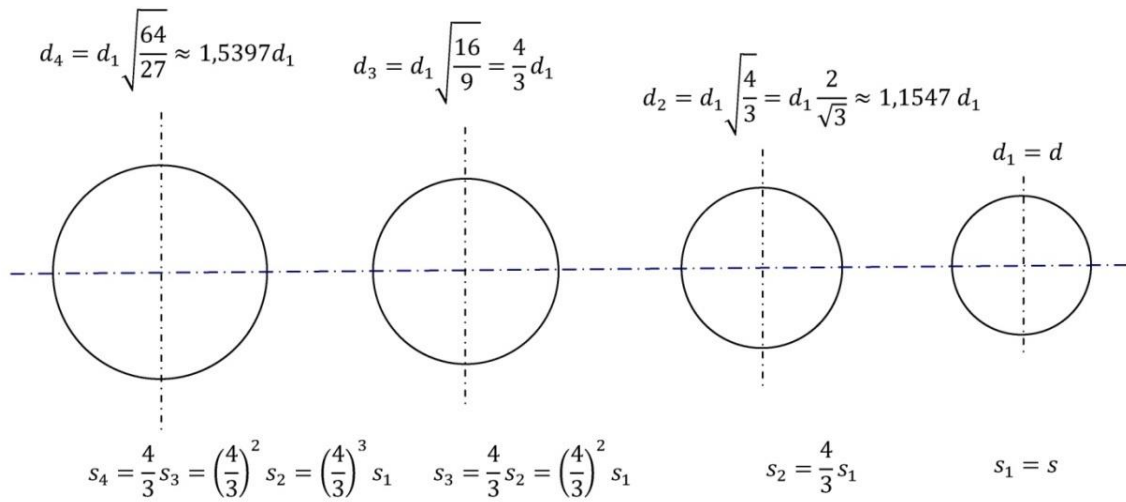

FHT 11 Proportions of the strings of the ‘ūd according to (ibn a-t-) Ṭaḥḥān’s *Hāwī-l-Funūn wa Salwat al-Maḥzūn*³⁶¹; s_1 to s_4 are the cross-sections, d_1 to d_4 are the diameters of the string from *zīr* to *bamm*. The proportions are originally given by weight of the string by this theoretician, which corresponds to proportions by the section (with the weight – if the material of the gut is homogeneous – being proportional to the section of the string and to its length as the product of the multiplication of the two values equals the volume of the string). Ṭaḥḥān also proposes the same proportion “by sight” – meaning by their thickness or diameter. The corresponding diameters and thicknesses are shown as “Ṭaḥḥān II” in THT 2:177 while the set shown in this figure – which is more realistic with regard to a possible fretting of the ‘ūd – corresponds to “Ṭaḥḥān I” in the same THT 2, and in THT 3:177.

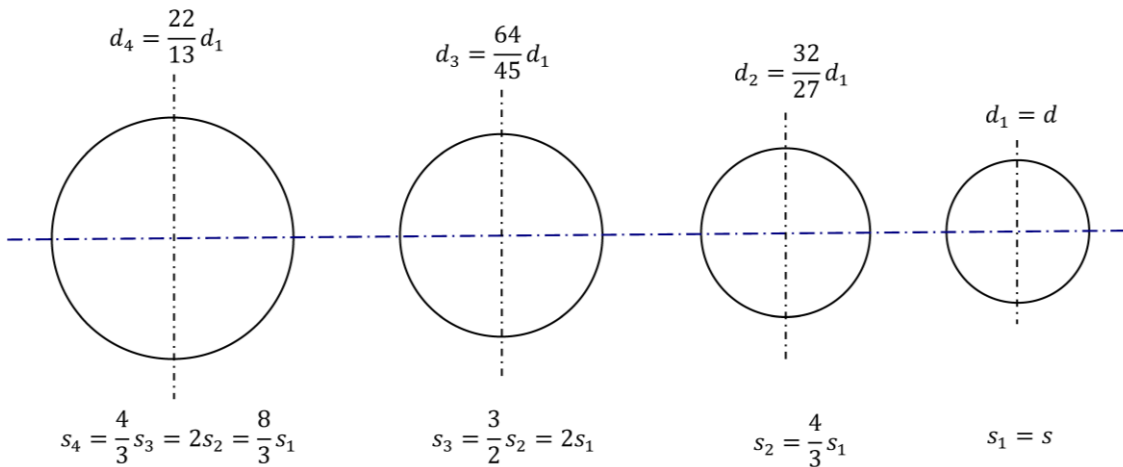

FHT 12 Proportions of the (silk) strings of the ‘ūd according to *Kanz a-t-Tuḥaf*; s_1 to s_4 are the cross-sections, d_1 to d_4 are the diameters of the string from *zīr* to *bamm*.³⁶² (Not including the thinnest string – the *ḥād*.)

³⁶¹ Originally published in [Beyhom and Makhlouf, 2009].

³⁶² Following the hypothesis that the diameters of the twisted threads of silk remain unchanged after the twisting – see Fig. 26:147 and the corresponding footnote.

A digression: When theory contradicts practice (and facts)

The lengthening of the strings as a result of concurrent stopping of the strings and of the presence of solid frets such as those described by Kindī is examined here.

Fārābī, as well as (ibn) Sinā and his student (ibn) Zayla³⁶³, all three state that there is a significant modification of the tension in the strings of the ‘ūd when these are stopped: I show that this modification is in fact insignificant when the instrument is not fretted.³⁶⁴

The arguments of the three authors are similar, of those below (ibn) Zayla’s (see FHT 14:169 and FHT 15:169):

“If the *mushṭ* [bridge] – or the *anf* [nut] – is so high that the strings would be far from the fingerboard,³⁶⁵ stopping the string will lengthen it because, instead of forming a straight line it would form 2 lines delineating the unstopped string. Thus, and the sum of the lengths of two sides of a triangle being greater than the length of the third side, the string can but lengthen, and lengthening modifies the register [*a-ṭ-ṭabaqa*] and produces a higher sound³⁶⁶.”³⁶⁷

FHT 15:169 shows a ‘ūd in cross-section (the missing parts are shown in dashed lines), with raised bridge and nut for clarity.

While the height of the bridge does not exceed 8 mm on modern ‘ūd(s), and the height of the nut does not exceed 1 mm (see an example of Modern ‘ūd in FHT 13:168 and compare with the neck of Hamdi Makhoulf’s ‘ūd with a raised nut in FHT 22:177), we

³⁶³ Among other authors.

³⁶⁴ For realistic proportions of ‘ūd(s): very high nuts or bridges can affect the results shown below in the text.

³⁶⁵ Although (ibn) Zayla’s statement seems coherent, it lacks of precision about the exact height(s) for bridge, nut and “ties”: for modern ‘ūd(s) and as shown below, the exact height of the bridge (or the nut) plays a major role for the perception of the difference between two pitches.

³⁶⁶ Note that a lengthened string, strictly speaking – and theoretically – and with all other variables (except the frequency) being equal, would sound “lower” acoustically as shown by Taylor’s formula expounded further; this would occur only if the tension of the string remains unchanged, in which case the frequency would drop in order to compensate the lengthening of the string (in the formula).

³⁶⁷ [Zayla (ibn), 1964, p. 76].

³⁶⁸ For this and other organological procedures about the fretting of the ‘ūd, the two videos originally made by Hamdi Makhoulf for the

shall simplify the problem by positing that the contact points between the string and the fingerboard as well as between the string and the nut or the bridge are ideal (points).³⁶⁸

Provided (see FHT 14:169) the total vibrating length of the string is L_0 , and that the string is stopped somewhere on the fingerboard at a contact point dividing it in 2 parts L_{SO} (Length of the – lengthened – string in direction of the nut) and L_{CO} (Length of the – lengthened – string in direction of the bridge), and the projections of these string-parts on the fingerboard of the ‘ūd be L_{SO} and L_{CO} (which are the corresponding lengths of L_{SO} and L_{CO} when these are not lengthened).³⁶⁹



FHT 13 The neck of a Modern ‘ūd³⁷⁰

CIM09 were still available (on the 21st of October 2020) at (respectively) <http://www.hamdi-makhoulf.com/cim09/video-1-kindi.mp4> and <http://www.hamdi-makhoulf.com/cim09/video-2-tahhan.mp4> – and referenced as [Makhoulf, 2009a ; 2009b]. Two other copies, subtitled in English by Amine Beyhom, have been made available on YouTube at https://youtu.be/d7TTInH_pKM and <https://youtu.be/demT-hpcX1s>. These videos are practical demonstrations of some organological problems raised by the fretting of the ‘ūd. For both Kindī and (ibn a-ṭ-) Ṭaḥḥān, two divisions of the fingerboard, “Harmonic” and Pythagorean with two different sets of strings, are experimented.

³⁶⁹ We will also contend that the effective length of the unstopped string is (nearly) equal to its projection L_0 in FHT 14.

³⁷⁰ Retrieved 20/10/15 from [Anon. “Mike Ouds - My Ouds Page”]: “This oud was made in 1925 by the oudmaker, Mohamad el-Hif-nawi. It was owned by Mohamad el-Qasabji [...]”

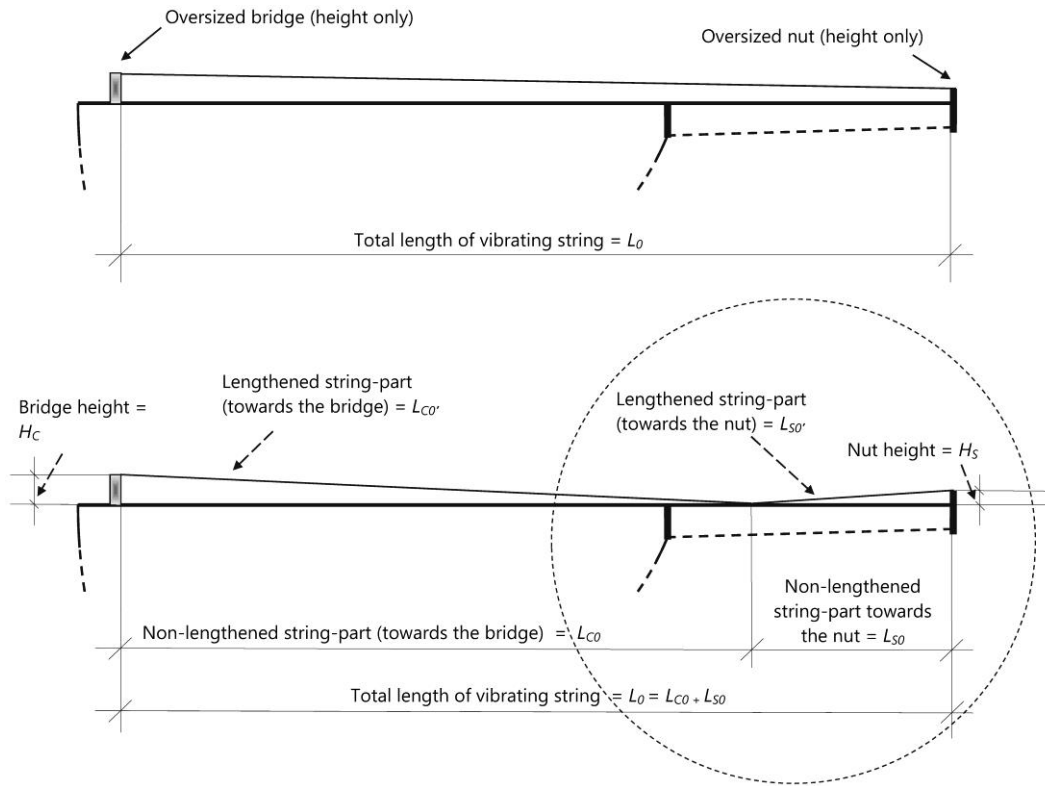

FHT 14 Lengthening of a ‘ūd string when stopped on the fingerboard. Above: length-section of the ‘ūd with unstopped string. Below: same as above, with a stopped string. The bridge and the nut are oversized in height. The circled part is magnified in the next figure. (“Vibrating string” = speaking length of the string.)

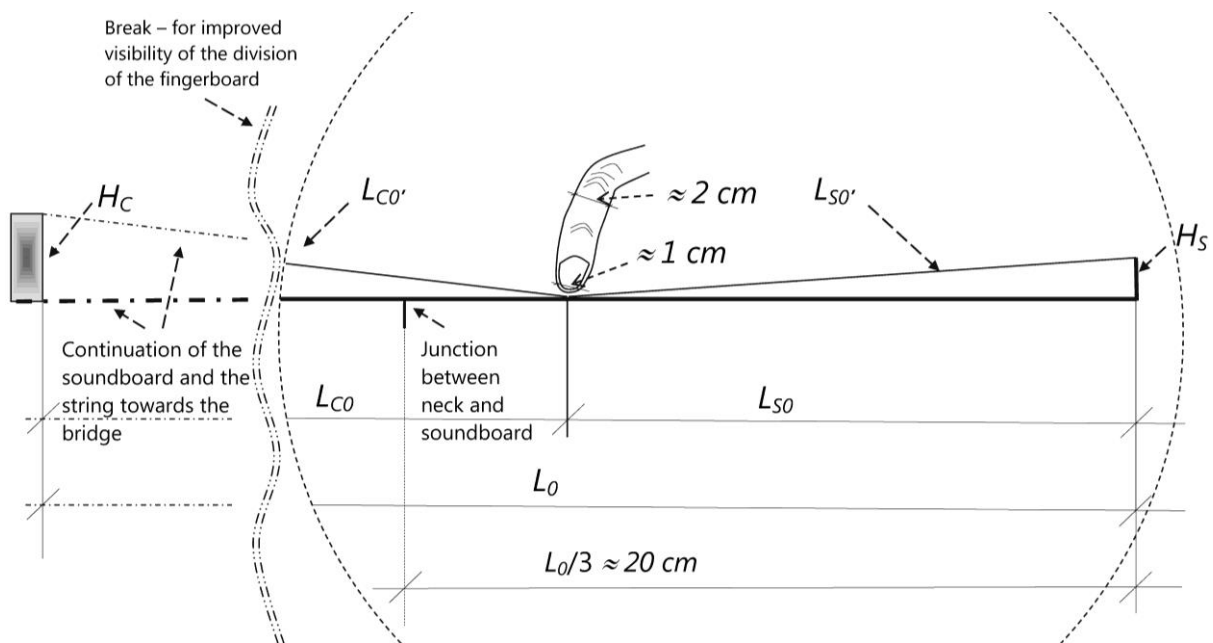

FHT 15 Lengthening of a ‘ūd string when stopped on the fingerboard – magnified length section of the fingerboard. The thickness of the stopping finger is approx. 2 cm, the tip of the finger is approx. 1 cm. Lengths of the total speaking length of the string ($L_0 = 60$ cm) and of the string-part over the soundboard ($L_{c0} = 2 L_0/3 = 40$ cm) and over the neck ($L_{s0} = L_0/3 = 20$ cm) are coherent with Kindi’s description, and with the proportions of modern ‘ūd(s)

L_{so} and L_{co} compose each a triangle with, respectively, the nut and L_{so} , and with the bridge and L_{co} , while forming right-angle corners with the nut or the bridge.

The total speaking length, and lengthened, string $L_{o'}$ is equal to the sum of the two lengthened string-parts, be it $L_{so'} + L_{co'}$. If we apply Pythagoras' formula for right-angle triangles, then:

$$L_{o'} = \sqrt{L_{so}^2 + H_s^2} + \sqrt{L_{co}^2 + H_c^2} \quad (1)$$

where H_c and H_s are, respectively, the heights of the bridge and of the nut, and where L_{so} and L_{co} are the lengths of the projections of $L_{so'}$ and $L_{co'}$ on the finger-board of the 'ūd (or the lengths of the unshortened string-parts L_{so} and L_{co}).

Replacing variables H_c , H_s , L_{so} and L_{co} with realistic values, and stopping the string at 1/3 of L_o ³⁷¹ (estimated at 60 cm, the third of which is 20 cm) from the nut and the heights of the nut and the bridge being given values respectively equal to 0,1³⁷² and 0,8 cm, and applying formula (1) we get:

$$\begin{aligned} L_{o'} &= \sqrt{20^2 + 0,1^2} + \sqrt{40^2 + 0,8^2} \\ &= \sqrt{400,01} + \sqrt{1600,64} \\ &= 20,00025 + 40,0008 \\ &= 60,0015 \text{ (cm)}. \end{aligned}$$

The proportional lengthening of the string will be $(60,0015-60)/60 = 0,000025\%$ which is negligible, be it for the tension (see Taylor's formula below) or for the length of the string.

³⁷¹ Which corresponds to a just fifth.

³⁷² The highest point in the fret must be as close as possible from the nut to facilitate performance while allowing for (1) a complete stopping of the string (it must be sufficiently thick for that purpose) and (2) higher (thicker) than the following tie-frets (towards the bridge), for these not to stop the string before the tie-fret which precedes them. This is why the bridge is always, in guitars for example but also in 'ūd(s), higher than the nut as the asymmetrical disposition of the string (higher to the side of the bridge) allows for more homogeneous thicknesses of the frets. The whole process consists in finding an acceptable compromise between organological constraints (and imperfections, such as slight unevenness of the neck and others) and ease of performance. In the case of the prototype-'ūd shown in FHT 16 sq., with a nut with 1 mm height and the bridge being 8 mm high, the tie-fret of the *sabbāba*, considered to be 1 mm thick, would be close to the string without touching it which is ideal for performance as less pressure is needed to stop the string. For our reconstruction of the "frettings" of Kindī and (ibn) Ṭaḥḥān with musicologist and 'ūd player Hamdi Makhoulouf from Tunisia (see [Beyhom and Makhoulouf, 2009] and FHT 26: 180 sq.), and due to the thickness of the tie-frets described by Kindī and Ṭaḥḥān,

The only difference in frequency occurs because of the shortening of the string when stopped.³⁷³

However, and if the height of the bridge be, for example, (H_c) 3 cm, the resulting length of the stopped string would be:

$$\begin{aligned} L_{o'} &= \sqrt{20^2 + 0,1^2} + \sqrt{40^2 + 3^2} = \sqrt{400,01} + \sqrt{1609} \\ &= 20,00025 + 40,11234 = 60,11259, \end{aligned}$$

which is approx. one mm lengthening for 60 cm of total length which, when applying the modified Taylor's formula³⁷⁴ $T = 4(mLF)^2$, where T is the tension of the string in Newtons, m is its mass in Kgs, F is the frequency and L is the length of the string in meters, gives a proportional difference in tension (provided that – to simplify – the mass and the frequency remain unchanged):³⁷⁵

$$\frac{T_2}{T_1} = \left(\frac{L_2}{L_1}\right)^2,$$

with the tension being proportionate to the length.

The proportional difference in tension would then be:

$$\left(\frac{60,11259}{60}\right)^2 = 1,003758,$$

which is about 75 times more as with $H_c=0,8$ cm for which the differential would be

$$\left(\frac{60,0015}{60}\right)^2 = 1,00005.$$

This being clearer, let us examine the stopping of a string on the ties mounted on the neck of the instrument.

The comments of the cited early authors are explicit for this point: strings must be stopped directly on the

we had to raise the nut by adding a layer under it (FHT 22: 177 – this solution was suggested by Richard Dumbrell who worked concurrently on the reconstruction of the Silver lyre of Ur), making thus the performance possible.

³⁷³ Note that for instruments such as the Indian *sitār*, which have thick frets (curved and placed far away from the hollow neck – see for example <https://bizimages.withfloats.com/actual/596c8fb1966b6d0b9005204d.jpg>, last visited 2019/12/20), the lateral pressure of the finger on the already stopped string induces a substantial lengthening, concurrently with increased tension and heightened pitches – see an example of performance in [The Biryani Boys, 2008].

³⁷⁴ See <http://www.physics.usyd.edu.au/~cross/StringTension.pdf> (last downloaded 08/01/20) and http://pianomaker.co.uk/technical/string_formulae/ (last visited 08/01/20).

³⁷⁵ Which is not the case, but I am avoiding here the complex formulation that would arise from an equation with three unknown variables.

ligatures to obtain the correct pitch. Yet this formulation is inconsistent with “physical” tie-frets the thickness of which is not negligible – such as Kindī’s and Ṭaḥḥān’s.

As all performers on fretted lutes (such as Western lutes, guitars and mandolins, etc.) know, quality emission of notes on these instruments means stopping the string *just before* the tie-fret or fret, as close as possible to it without compromising the quality of the sound.

FHT 16:172 illustrates these two specific cases as length sections of the fingerboard, on a ditonic division (Pythagorean) of the fingerboard materialized as ties of homogeneous thickness = 1 mm.

The main reason for the stopping of the string *before* the tie is acoustical and organological: fingertips³⁷⁶ have incompressible thicknesses. When stopping the string directly on the tie the borders of the fingertips will inevitably exceed this point by a few millimeters³⁷⁷ which creates an unpleasant buzzing sound. The best sound is obtained when the string is stopped a few millimeters before the ligature.³⁷⁸ Therefore, an indication for stopping the strings *on* the ligature is an indication that the “tie-frets” are line markers drawn on the neck, or would be very thin tie-frets.

As for playing *between* ligatures, FHT 17:172 shows that, even with “thin” tie-frets only 1 mm thick,³⁷⁹ the string will effectively be stopped on the tie *below* it.³⁸⁰ In the figure, this would be the *wustā* when pressing the string between the *sabbāba* (index) and the *wustā* (middle finger).³⁸¹

Note that there exists a possibility, in the case of a (very) high bridge, that the string stopped closer to the *sabbāba* (index) in FHT 18:172 would not even make junction with the *wustā* (middle finger). This would be an exceptional case {for ‘ūd(s)} and inconsistent for the organology of the instrument as the performer’s task

would be much more difficult (he would have to be much more precise in his performance and exert much more pressure on the string to be able to stop it correctly). Furthermore, modification in pitch *would* occur in such case due to the lengthening of the string.

(See also Appendix B for more details on “ties”, “ligatures” or “frets”.)

* *
* *



Fig. 29 Detail from “Two men having fun with music” (c. 1300) from Staatsbibliothek zu Berlin, Diez A, f.71, S11-2; (copyright Staatsbibliothek zu Berlin, Preussischer Kulturbesitz, Orientabteilung).³⁸²

³⁷⁶ Which can be estimated as 1 cm, for an estimated 2 cm for the finger.

³⁷⁷ Due to the thickness of the fingertips.

³⁷⁸ This observation (which is commonplace among performers on fretted lutes) comes from my experience as a guitarist, but also from the aforementioned reconstruction of the frettings of Kindī and Ṭaḥḥān with Hamdi Makhlof.

³⁷⁹ Compare this to ties 8 mm thick as the ones advocated by Maalouf for Kindī’s “fretting” in the section of Appendix B below entitled “Impracticality of the performance with dense divisions”.

³⁸⁰ To the left in the figure. On fretted instruments, to sound the desired note, the string must be stopped just before the “fret” (ligature) corresponding to it; this means that whatever the position between the *sabbāba* and the *wustā*, the note sounded would be the

pitch (note) of the upper tie-fret (the *wustā* in the figure). However, stopping the string near the *sabbāba* (and after it, in the space between *sabbāba* and the *wustā*) will (1) produce an unpleasant sound and (2) can in extreme cases (see below in the text) fail at stopping the string on the *wustā*.

³⁸¹ This is in fact the main reason for mounting frets on a lute, as the performance will be much easier, although limited melodically, because the performer needs no more be (so) precise in his stopping of the string. An approximate stopping precision is enough to emit an acceptable sound. Note also that, in the case of stopping nearer to the “higher” fret (to the right – the *sabbāba* in FHT 18), what changes is mostly the quality of the emitted sound (which becomes worse – with regard to traditional performance).

³⁸² From [Tsuge, 2013, p. 258].

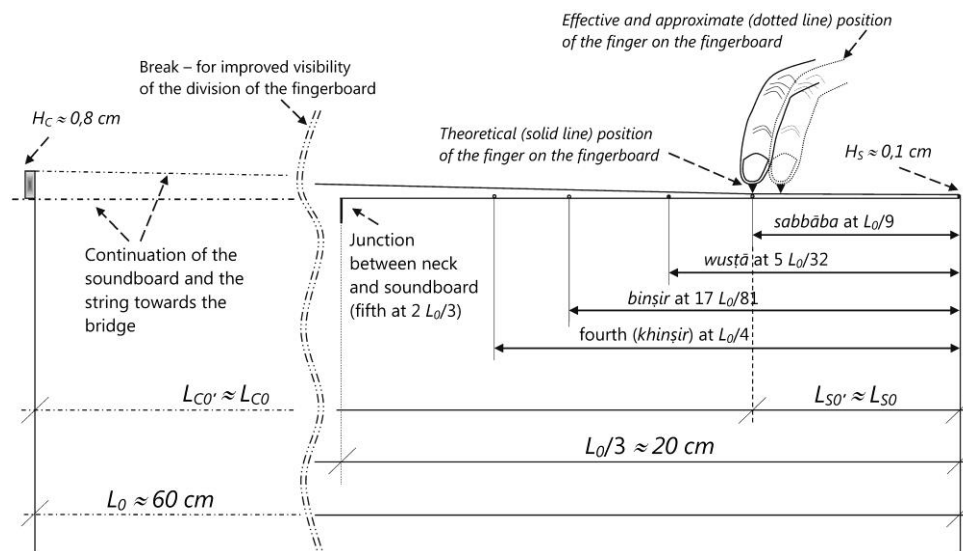

FHT 16 Two positions for the stopping finger on the tie of the *sabāba* (heights of bridge and nut are realistic = correspond loosely to the measurements of ‘ūd(s) nowadays). The 1st position (theoretical and to the left, mentioned by all early authors) is not advised if the ‘ūd is mounted with solid tie-frets (“deafness” of the sound occurs), but is coherent with the use of fretless instruments. The 2nd position (to the right in dotted lines) is the (approximate) correct position for a fretted instrument (such as a guitar). The thickness of the fret (tie-fret, ligature) is 1 mm.³⁸³

FHT 17 Advised position to make the string sound at the length of the *wustā* (at $27 L_0/32$), between the tie-frets of the *sabbāba* (index) and the *wustā* (middle finger). Organological configuration (proportions) is “normal”: the string is mounted the closest possible to the tie-frets (and to the fingerboard) for a better quality of the performance; the stopping occurs just before the *wustā*. (“Tie” in the figure = “tie-fret”).

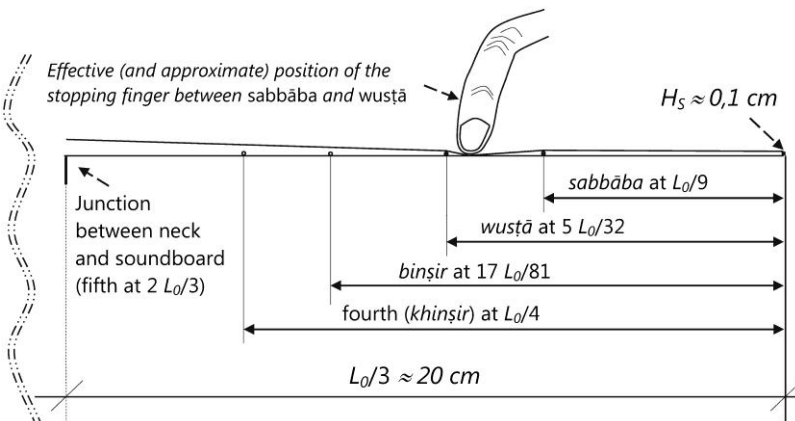

FHT 18 Not recommended stopping of the string at the length of the *wustā* ($27 L_0/32$), between the tie-frets (“ties” in the figure) of the *sabbāba* (index) and the *wustā* (middle finger). The stopped string will “sizzle” or “crackle” (will be accompanied by “squeaks” according to Kindī – see Part II). If the bridge is oversized in height, it is possible that the string will not even touch the tie of the *wustā*.

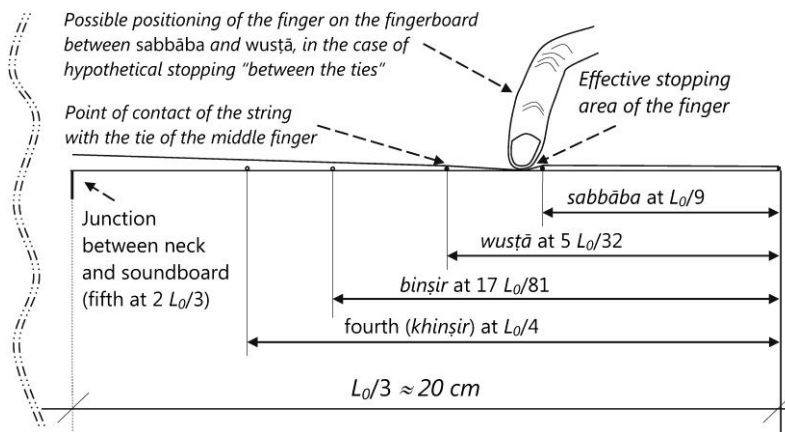

³⁸³ The tie-frets are not, in these figures, winded twice (as described by Kindī – see Fig. 25: 146, and as attested for example for the *sāz*) as to avoid additional complexity of the graphic representation.

APPENDIX B: ORGANOLOGICAL CLARIFICATIONS

The fretting of the ‘ūd is one of the most controversial issues in Arabian musicology. Many studies published in the 20th century have conflicting opinions on a subject the essence of which appearing to stretch beyond organological matters.

Among manuscripts of the Arabian Golden Age from the 8th to the 11th centuries, only two describe a “fret” system made from ligatures tied at specific places on the fingerboard of the ‘ūd. As seen in the main text, the first description is from one of (al-) Kindī’s epistles and dates to the 9th century. The second is the 11th-Century description from (ibn a-t-) Ṭaḥḥān.

Both authors give relatively complete descriptions of ‘ūd tie-frets contradicting significant assertions of philosophers and theoreticians such as (al-) Fārābī, in the 9th and 10th centuries – who was known as the ‘Second Master’, Aristotelēs being the first – and (ibn) Sīnā, known to the West as Avicenna, and nick-named ‘the Commentator’ (of Aristotelēs), and also with other later writers such as Urmawī, a musician and theoretician of the 13th century, and Shirwānī in the 15th century. Furthermore, only few contemporary authors have studied the possibility of the ‘ūd fretted according to ancient descriptions.

In Early Arabian writings about music, both theory and practice use the instrument as a common denominator. Recent research³⁸⁴ has also shown the antecedence of the ‘ūd and its influence on the contemporary musical repertoire.

Significant peculiarities of the modern instrument, such as the semi truncated conical shape of the neck, possibly a smaller gap between strings and fingerboard, but also practice of subtle variations of intonation, different from any temperament-based systems, all contradict the premise that frets, or actual physical (consistent, thick) ligatures were used. However, the fretting thesis, which was promoted

³⁸⁴ [Beyhom, 2005].

³⁸⁵ See footnote no. 154:136.

by eminent musicologists such as Farmer and Neubauer, led to the broadly accepted assertion that the early “mediaeval” – in the Western acceptance – ‘ūd was fretted.

Nonetheless, descriptions of early practice contradict this assertion. Consequently, the main question explored in this appendix is: How would the instrument respond should it be fretted as described by Kindī and Ṭaḥḥān?

To answer this question, practical organological questions – notably Sachs’ remark on the shape of the neck of the ‘ūd –³⁸⁵ are examined.

* *

The fretting of the instrument was undertaken in 2008-2009 by Hamdi Makhlof. Two videos³⁸⁶ were produced, showing the making of four different frettings, with two sets of strings (for Kindī and Ṭaḥḥān respectively) and two tunings – Pythagorean and “Harmonic” – described by Kindī in his *Risāla fi-l Luḥūn wa-n-Naḡham*.

The following two sections address general organological problems concerning the fretting process, which should clarify, in the third section, the next examination of yet another difficulty arising from the multiplication of tie-frets on the neck of the instrument.

These clarifications are most needed for the purpose of this dossier and are justified, notably, by the zeal of Re-Orientalist musicologists who, while concurrently adopting the myth of the fretting of the ‘ūd, demonstrate that the Arabian divisions of the fingerboard were “perfect”.

* *

³⁸⁶ See footnote no. 368:168 for the two videos made by Hamdi Makhlof for the CIM09. These videos are practical demonstrations of some organological problems raised by the fretting of the ‘ūd.

About organological difficulties arising from the use of frets on the ‘ūd

Ties (“tie-frets” or “ligatures”) are commonly used on lute-type instruments, be it on Western lutes or others. As a general observation: frets are used mainly on long-necked lutes with a neck the two upper and lower sides (the edges of the neck) of which are (almost) parallel. This feature is also necessary for the Western exception, the fretted lute. When the neck is in the form of a truncated semi-cone (FHT 20:175), typical difficulties arise for the fretting procedure. Furthermore, some fretted long-necked lutes (for example the Iranian *tār*, *setār* and the *dotār*, exception made for the Turkish *sāz*) have a groove at the back of the neck to make it easier to tie the notes of the tie-frets on the instrument, while this procedure is not described anywhere for ties on the neck of the early ‘ūd.³⁸⁷

Moreover: we have learned from Fārābī that some notes on the ‘ūd are sounded when the strings are stopped *between* the “usual” *dasātīn* (ligatures), while others are sounded when the strings are stopped *on* the ligatures³⁸⁸ – not to mention (ibn) Sinā’s explanations about *portamenti* with the strings of the ‘ūd³⁸⁹.

All in all, using tie-frets restricts the performance to predetermined series of notes which narrow the possibilities of melodic expression for the performer. To solve – partly – this technical limitation, more tie-frets can be added. However, this raises new organological problems not thought through by Orientalist (and here, mainly, by Re-Orientalist) *maqām* musicologists, more concerned by their theoretical demonstration than by practical “details”.

These questions are mainly about the size and the numbers of the “tie-frets”. To show these difficulties, I will try to apply indications about the tie-frets as provided by Kindī, in conjunction with the emplacement of the stopping finger(s).

³⁸⁷ The tying of the tie-fret is always a delicate operation: see for example the YouTube videos [Zapico, 2015; PaololiutaiopD, 2010; Shepherd, 2016; Carey, 2017; Espinoza, 2015].

³⁸⁸ See Quote 1:138, Quote 2:139, Quote 11:140, Quote 13:148 and Quote 14:148.

³⁸⁹ Quote 15:148.

³⁹⁰ Shorter than the neck of the Western lute. Note that while Western lutes have frets, we do not know if this was the case from the beginning (which would be surprising). Moreover, Western lutes have – unlike the ‘ūd – wide, almost (semi-)cylindrical necks, with nearly no sloping of the

ON THE GLOBAL ORGANOLOGICAL IMPRACTICALITY OF TIES ON THE SHORT, SEMI TRUNCATED CONICAL NECK OF THE ‘ŪD

Let’s begin with common sense reasoning: today, the ‘ūd is not fretted (or mounted with tie-frets) and the best Conservatoire technicians are precisely very proud that they can perform chords or arpeggios with an accurate (*i.e.* as when playing on a well-tuned guitar) pitch and a “clean” (with no crackling or sizzling) sound on a fretless instrument.

As already explained, the ‘ūd has a short neck³⁹⁰. This implies that:

- The span (ambitus) on a string is generally reduced, in traditional performance, to a just fourth (or fifth).³⁹¹
- This in turn implies that there is not much place for tie-frets – much less as with a *tunbūr* – if these have substantial dimensions.
- This also implies that a non-equal-temperament division with vertical markers (and with a regular tuning in successive just fourths) can not as easily provide octave and fifth correspondences and, more generally, equivalences between the notes of one octave and another octave.
- This in turn implies that, in order to obtain these equivalences a multiplication of the tie-frets is necessary as for example in Kindī’s division in the *Risāla fī Khubr Šinā‘at a-t-Ta’lif* shown in Fig. 8:127.
- Furthermore, the neck of the ‘ūd has a semi truncated conical form, slightly flattened and limited by the nut on one side and by the body on the other side (FHT 19:175 and Fig. 9:131). In the course of performance, it is most probable that (even) a firmly knotted tie-fret will not remain in its original position – because of the lateral friction on the tie-frets – (FHT 20:175), which will make it inoperative.³⁹² (This applies even more when the hygrometry is high.)

neck (see for example the two plates inserted in [Hellwig, 1970, p. 64–65]) which prevents the tie-fret from losing its adherence to the neck as in FHT 20:175.

³⁹¹ It is hence more interesting to explore the infinite possibilities of “micro-modulation” within the span of one string, *i.e.* one fifth or a little more.

³⁹² See for example the Video no. 2 (Ṭaḥḥān – see footnote no. 394) between 5:36 (mm:ss) and the end, especially the third fret from the right, and more precisely around 6:19. The “tie-fret” of the *būṣīr* (third from the right) moves constantly while Hamdi Makhlof tries to play a melody on his fretted instrument.

FHT 19 Neck of a ‘ūd (based on Khulaī’s ‘ūd shown in FHT 5:161) mounted with a single tie-fret (“tie” in the figure); A and A’ delineate a cross section shown in (free) perspective view in FHT 20.³⁹³

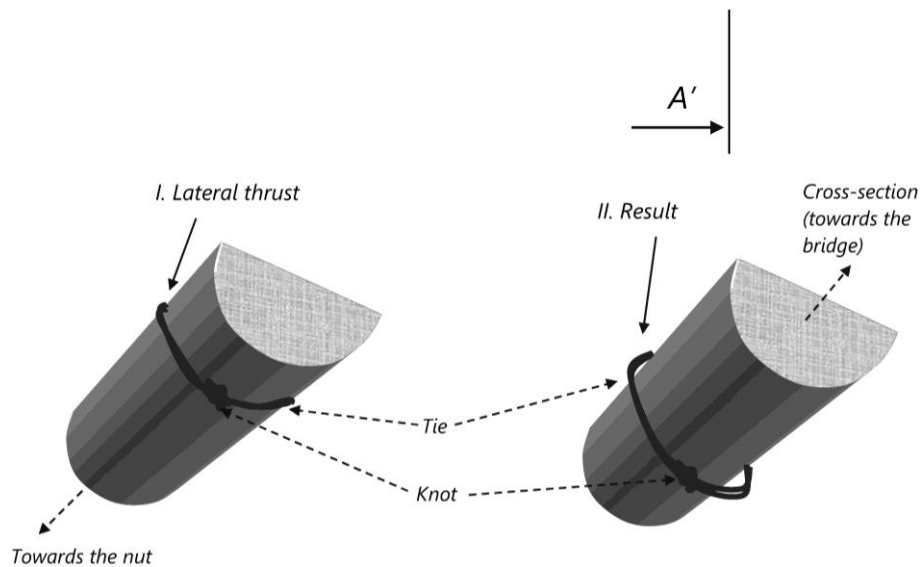
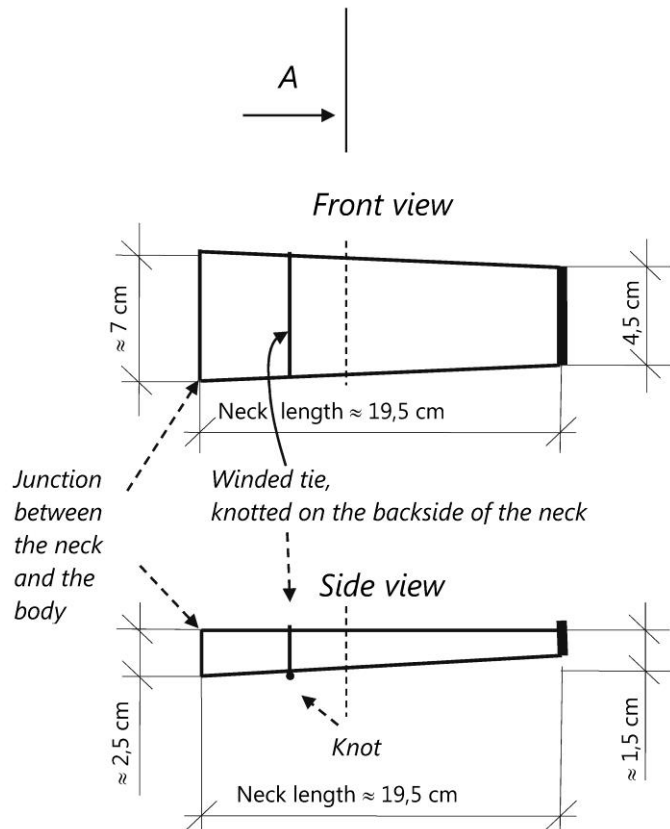

FHT 20 Free perspective view of section A-A’ in the previous figure. To the left: firmly knotted tie(-fret) on the neck. To the right: tie-fret displaced towards the nut because of wanted or unwanted (which may happen during the performance) lateral thrust: in this case, the tie-fret adheres no more to the surface and fingerboard of the neck, and becomes inoperative.

³⁹³ In the case of slightly conical necks, the fret can be tied on the thinner part, just before its intended position, then displaced towards (and on) the intended position, which will ensure a better fixation, but the problem of displacement remains (as, for example, with the Video no. 2 in the previous footnote); this could, furthermore, result in scratches on the neck which is highly *not* recommended.

PRACTICAL DIFFICULTIES FOR FRETTING THE *ʿūd* – AN EXPERIMENT³⁹⁴

Other problems arise when trying to reconstruct the frettings as proposed in the Arabian literature, such as with Kindī and Ṭaḥḥān – a task that no Orientalist (or Re-Orientalist) musicologist seems to have undertaken before our experiment with Hamdi Makhlof in 2009.³⁹⁵ This experiment aimed to recreate (or simply create) the frettings of the two early authors on a modern *ʿūd* – here the instrument of Makhlof shown in FHT 21.

Two sets of strings (and “tie-frets”) were used (FHT 26:180 & FHT 27:180) which were the closest in diameter, from the available gut strings from Savarez,³⁹⁶ to the proportions proposed by Kindī and Ṭaḥḥān (respectively FHT 9:166 and FHT 10:167) with, for the latter, the two proportions per weight (= per section) or per diameter (THT 2 & THT 3:177).

Two videos were produced about the fretting process and its results. The first video is named from here on “Video no. 1”. In this video, Makhlof uses the set of strings “Ṭaḥḥān II” (THT 2: – also named “Kindī II”). The *ūd* is strung,³⁹⁷ then fretted first according to the “Harmonic” system of Kindī, then according to the Pythagorean system of the same author. After mounting each set, Makhlof plays an improvised melody by positioning the fingertips of his left hand firstly *directly* on the frets, and secondly by positioning them before the frets.

The same procedure is applied in the second video (“Video no. 2”), using the set of strings “Ṭaḥḥān I” (THT 3:177).

³⁹⁴ (Reminder:) This section relies on the two subtitled in English videos available on YouTube at https://youtu.be/d7TTInH_pKM (for Kindī) and <https://youtu.be/demT-hpcX1s> (for Ṭaḥḥān).

³⁹⁵ By Makhlof with advice from the author. This experiment was part of a wider research undertaken with musicologist and *ūd*(ist) Hamdi Makhlof for the CIM09 (Cinquième Congrès Interdisciplinaire de Musicologie, Paris, Octobre 2009) conference, and the purpose of which was precisely a better understanding of organological specificities with regard the fretting of the *ūd*. The research is documented in [Beyhom and Makhlof, 2009] and in the aforementioned videos.

³⁹⁶ Note that Richard Dumbrill, who has an extensive experience in the making of gut strings, explained to me very recently and in a private communication that the Savarez strings, although they are

The two videos are explicit about the whole fretting procedure, and about the difficulties met by Makhlof during this process.



FHT 21 *ūd* used by Hamdi Makhlof to test the frettings.

made for Early period instruments, do not result from the same procedure as earlier gut strings; specifically, they are made according to a process originating in 16th-Century Italy, which is: gut strands are sliced (sometimes twice) in the direction of the length and hung to dry. A small rock of given weight is attached to the sliced strands at the bottom, after which the small rock is rotated till the strands are shortened for a given length. This procedure ensures that there are no gaps between the (sliced) strands of gut. The diameters of the resulting strings are then evened with a special tool to make them homogeneous all long, then oiled or varnished. Strings made following this procedure are generally more resistant and sound better than gut strings made in the traditional way.

³⁹⁷ And tuned in successive fourths.

String	<i>Bamm</i>	<i>Mathlath</i>	<i>Mathnā</i>	<i>Zīr</i>
Kindī I (section)	$d\sqrt{4}$ (2d)	$d\sqrt{3}$ (1.73d)	$d\sqrt{2}$ (1.41d)	d
Ṭaḥḥān I (weight)	1.54d	1.33d	1.15d	d
Ṭaḥḥān II (diameter) (Kindī II)	2.37d	1.78d	1.33d	d

THT 2 Diameters of the strings expressed as a function of the (weight or the diameter d of the) thinnest string, the *zīr*, as given (as proportions) by Kindī and Ṭaḥḥān. In the second possibility for Ṭaḥḥān (“Ṭaḥḥān II”), diameters of the strings are nearer to those of Kindī I – apart from the *bamm*, clearly thicker in Ṭaḥḥān II. The set of strings “Ṭaḥḥān II” is renamed “Kindī II”.

String	<i>Bamm</i>	<i>Mathlath</i>	<i>Mathnā</i>	<i>Zīr</i>
Ṭaḥḥān I (weight)	0.81 (0.82)	0.71	0.61	0.53
Kindī II (diameter with Ṭaḥḥān)	1.27 (1.26)	0.94	0.71	0.53

THT 3 Closest string-diameters to the strings proportions of Kindī and Ṭaḥḥān with Savarez gut strings, taking the *zīr* string to be 0.53 mm in diameter (equivalent to d). (For the *bamm* string, values between brackets are the “ideal” – i.e. computed according to the two theoretician’s explanations – values, while the values outside the brackets are the effective values of the closest – in diameter – Savarez gut strings.)

One of the difficulties which arose while fretting the instrument was the exaggerated diameters of the *bamm* and *mathnā* strings, mostly for the set “Ṭaḥḥān II” (or “Kindī II”), for which the tying of the frets was very difficult due to their thicknesses.

This is also illustrated in the photographs of FHT 22:177 and FHT 25:180, in which the non-adherence of the tie-frets to the surface of the fingerboard³⁹⁸ is evident when using string thicknesses as advocated by this early author (FHT 26:180), which in turn creates problems.³⁹⁹

Secondly, the thickness of the tie-frets compelled Makhlof to insert a wooden piece beneath the nut (FHT 22:177)⁴⁰⁰ to raise it in such a way as for the strings not to be in permanent contact with the frets.

³⁹⁸ This phenomenon is also due to the fact that the fingerboard is completely flat, with relatively sharp edges which (1) results in the non-adherence of dick ties as the ones shown in this figure and (2) creates additional tension of the ties at the edges which can lead them, eventually, to sever.

³⁹⁹ See Video no. 1, beginning 04:33 (mm:ss).

This created definite difficulties for playing the instrument, whether directly on the tie-frets (more difficult with an unpleasant sound) or before them (less difficult but still with an unpleasant sound).

Moreover, the tie-frets did not adhere well to the fingerboard (FHT 22:177) and moved laterally during the attempted performance of an improvised melody.



FHT 22 Specific difficulties arise in the process of mounting the ties on the neck of the ‘ūd following the indications of Kindī in the *Risāla fi-l Luḥūn wa-n-Naghām*. Here, the tie-frets do not adhere to the surface of the fingerboard because of undue rigidity (due to the thickness) of the material of the first two tie-frets. (Note the wooden layer beneath the nut piece which was added to raise the strings.)⁴⁰¹

While the second set of strings (“Ṭaḥḥān I”) was easier to install and allowed as well for an easier tying of the nots of the tie-frets, the difficulties did not disappear, with the same (but less) unpleasant resulting sound and lateral displacements of the tie-

⁴⁰⁰ See Video no. 1, 01:40 (mm:ss) to 02:00.

⁴⁰¹ Note that today in Iran the thickest tie is 0.8 mm (diameter) for the *tār* with relatively finer (slimmer) ties towards and after the fifth. In Central Asia, the thicknesses can reach up to 1 mm. (Private communication from Jean During.)

frets – although less accented – during the performance.



FHT 23 Pythagorean division according to Kindī, with a very thick *bamm* string; the photo shows the tie-frets of the *sabbāba* (index – above, with a *bamm* string) and of the *wustā* (middle finger – below, with a *mathlath* string).

Concluding on this point, there exist many organological problems which should be thoroughly examined before asserting that Early ‘ūd(s) were fretted, as some (re-) Orientalist musicologists still do.

*
* *

IMPRACTICALITY OF THE PERFORMANCE WITH DENSE DIVISIONS

I shall combine here, for the sake of demonstration, two descriptions of divisions of the fingerboard of the ‘ūd, the first by Fārābī as described by Maalouf⁴⁰² and Abou Mrad⁴⁰³, the second being Kindī’s description of the tie-frets (and their interpretation by Maalouf). The “complete” division of Fārābī (FHT 28:181) has 12 possible locations on the

⁴⁰² [Maalouf, 2002].

fingerboard, which Maalouf and Abou Mrad liken to “frets”. The “frets” are used on the whole width of the fingerboard for some (Maalouf) or all (Abou Mrad – FHT 32:183 and FHT 33:183) of them.



FHT 24 Pythagorean division according to Ṭaḥḥān; the horizontal marks seen above or below the actual tie-frets correspond to the positionings of the “Harmonic” tie-frets. With this set of strings (“Ṭaḥḥān I”), the tie-frets stick better to the surface of the fingerboard and are easier to place and tie around the neck.

The first practical difficulty, if these “ligatures” were made of physical material (more than marks or thin threads of silk for example), lies with the *wustā*(s) and their octaves. The “simple” *wustā* (at 27/32) and the Persian *wustā* (at 64/81) are, in the most favorable case when the cross-section of the ligature is nil, located at a distance from each other which is equivalent to:

$$\frac{27L_0}{32} - \frac{68L_0}{81} = \frac{27 \times 81 - 32 \times 68}{32 \times 81} L_0 = \frac{2187 - 2176}{2592} L_0$$

⁴⁰³ [Abou Mrad, 2005].

$$= \frac{11}{2592} L_0 = 0,004244 L_0.$$

Replacing by the typical length of a ‘ūd string L_0 , of a speaking length of 60 cm, the distance between the two ligatures will be 0,255 cm, which is 8 times smaller than the thickness of a finger (estimated as 2 cm)⁴⁰⁴ and 4 times smaller than the thickness of the tip of the finger (estimated as 1 cm). This obviously creates a difficulty for the precision of the stopping of the string at the exact locations mentioned by Fārābī. The same reasoning can be applied to the “frets” located at $17/18 L_0$ and $243/256 L_0$.

This difficulty is increased closer to the nut (for the location of the *Persian wuṣṭā* at $2175/2187 L_0$) as the pressure exerted by the performer in order to stop correctly the string for this position is considerably greater than the pressure needed to stop the string at the location of one of the other *wuṣṭā*(s).⁴⁰⁵

The aforementioned difficulties increase exponentially with physical tie-frets, especially for those suggested by Maalouf in her *History of Arabic Music Theory*.⁴⁰⁶ In this book,⁴⁰⁷ and while discussing the division of the fingerboard in Kindī’s *Risāla fī-l-Luḥūn wa-n-Naḡham*, Maalouf assigns (FHT 29:181) a thickness of 8 mm⁴⁰⁸ to the tie-fret of the *sabbāba* (index) made of two folds of *bamm* string, 6 mm to the tie-fret of the *wuṣṭā* (middle finger) made of two folds of *mathlath* string, 4 mm to the tie-fret of the *biṣīr* (annular) made of two folds of *mathnā* string and 2 mm to the tie-fret of the *khinṣīr* (auricular) made of two folds of *zīr* string.

As shown in FHT 30:182 and FHT 31:182, with these tie-frets (for the *sabbāba* – index) the effective tangent point between the tie-fret and the string is

offset by more than 1,5 mm, which would change the pitch of the note.⁴⁰⁹

Additionally, using tie-frets such as the ones suggested by Maalouf with Fārābī’s division of the fingerboard would lead to considerable difficulties due, firstly (FHT 32:183), to the entanglement (overlapping) of tie-frets at some locations,⁴¹⁰ or due to their unreasonable proximity with one another in other locations which creates – in the first case – an impossibility of the performance and – in the second case – impractical areas in which the performance is – at the very least – difficult.

It is evident that no professional ‘ūd player would choose such a configuration for his instrument. On the other hand, and if we use moderately thick tie-frets such as, for example, $2 \times 1\text{mm}$ tie-frets with standardized cross-section, FHT 33:183 clearly shows, for this realistic (if “tie-frets” are not virtual) fretting, the existence of impractical areas, with one probable area of impossibility of the performance for either of the *wuṣṭā*(s).

How, after such a demonstration of the impracticality of physical frets for the Arabian divisions on the fingerboard of the ‘ūd could we possibly accept the hypothesis of the fretting of the instrument?⁴¹¹

⁴⁰⁴ Note that the thickness of the auricular is approximately the half of the thickness of the other fingers (and the thumb being even thicker), but this plays no role in our reasoning because the finger in question here is the middle finger (*wuṣṭā*).

⁴⁰⁵ The string is stiffened near the nut and the bridge, with the result that more pressure is needed for stopping the strings near the nut, and consequently less pressure is needed in the central part of the string.

⁴⁰⁶ [Maalouf, 2002].

⁴⁰⁷ Mainly a compendium of Orientalist musicology of the *maqām*.

⁴⁰⁸ [Maalouf, 2002, p. 94]: “the *bamm* string tied twice around the *sabbābat* fret fills an area of 4 mm on each side of the fret [...] The *mathnā* string tied twice around the *biṣīr* fret fills an area of 2 mm on each side of the fret [...]”.

⁴⁰⁹ With such thick tie-frets, and knowing that almost all early (and less early) authors insist on a precise stopping of the finger *on* the tie, we may wonder and ask ourselves: “on which *part* of the tie-fret should I stop the string”.

⁴¹⁰ I wonder if it is possible to tie a knot when the tie-frets overlap.

⁴¹¹ Especially when such frettings are supposed to ease the performance.



FHT 25 Reconstructed Harmonic division of Kindi in the *Risāla fi-l Luḥūn wa-n-Nagham*, using tie-frets of the set “Kindi II”.



FHT 26 Set of gut strings “Kindi II” used in the reconstruction of the “fretting” of Kindi’s *Risāla fi-l Luḥūn wa-n-Nagham* with diameters, from *zīr* (thinnest string) to *bamm* (thickest string): 0.53 mm, 0.71 mm, 0.94 mm and 1.27 mm.⁴¹²



FHT 27 Set of strings “Ṭaḥḥān I” with similar proportions as given by Ṭaḥḥān (proportional weights/sections) with diameters, from *zīr* to *bamm*: 0.53 mm, 0.61 mm, 0.71 mm et 0.81 mm.

⁴¹² Detailed information for the procurement of thicknesses of strings for Kindi’s and Ṭaḥḥān’s *‘ūd*(s) is available in [Beyhom and Makhlof, 2009].

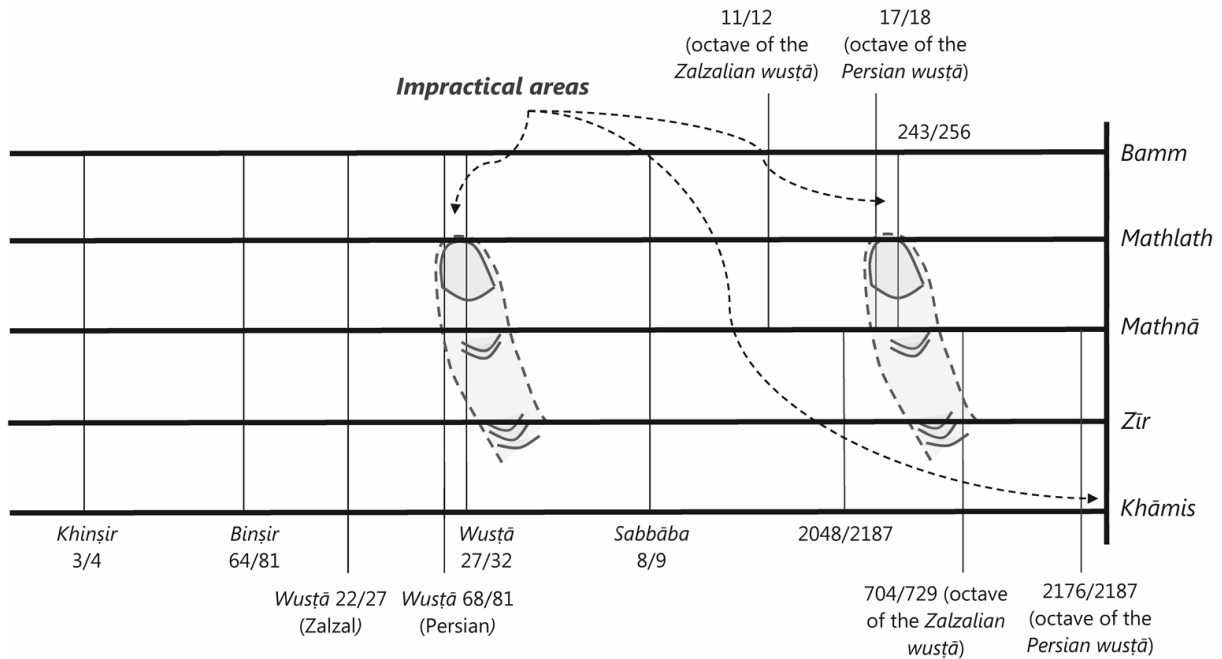

FHT 28 Impractical areas appear when including the octave equivalences for the scale of (al-) Fārābī as described by Maalouf.⁴¹³ This figure is adapted and translated from [Beyhom, 2010c, v. 1, p. 175, 357]: virtual fingers reproduced in the figure are approx. 2 cm wide.

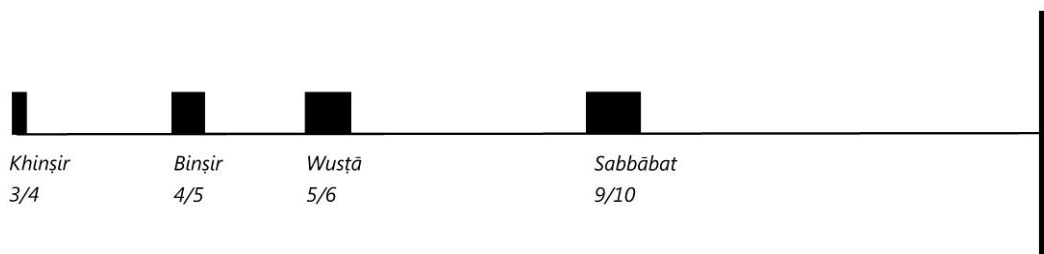

FHT 29 Computer re-created copy of the upper part of figure no. 3.5 in [Maalouf, 2002, p. 94], showing the proposed thicknesses of Kindī’s tie-frets described in the *Risāla fi-l-Luḥūn wa-n-Naḡham*.

⁴¹³ [Maalouf, 2002, p. 126]. Many musicologists maintain that the Early Arabian ‘ūd was “fretted” notwithstanding the complex divisions described by Arabian theoreticians, and forgetting (or overlooking) the fact that some of the positions for the notes are alternative positionings, as here for the *wustā*(s). Moreover: “tying frets” on only half of the neck (as for the first six positions beginning from the right) is a practical impossibility. Note that this description is espoused in [Abou Mrad, 2005, p. 773–774] with “full frets” on the fingerboard. In the same reference, Abou Mrad cites [p. 784] Maalouf’s book and asserts that “frets were associated to the fingers of the left hand and placed on the fingerboard of [the ‘ūd] till the end of the Middle Ages” (“des frettes associées aux doigts de la main gauche sont disposées sur la touche [du ‘ūd] et ce, jusqu’à la fin du Moyen Âge”). Note also that Shireen Maalouf is a pianist, while Abou Mrad is a violinist, (both being Ph.D. holders from Université du Saint-Esprit – Kaslik in Lebanon) which would explain their non-familiarity with the specificities of the fretting of lute-type instruments.

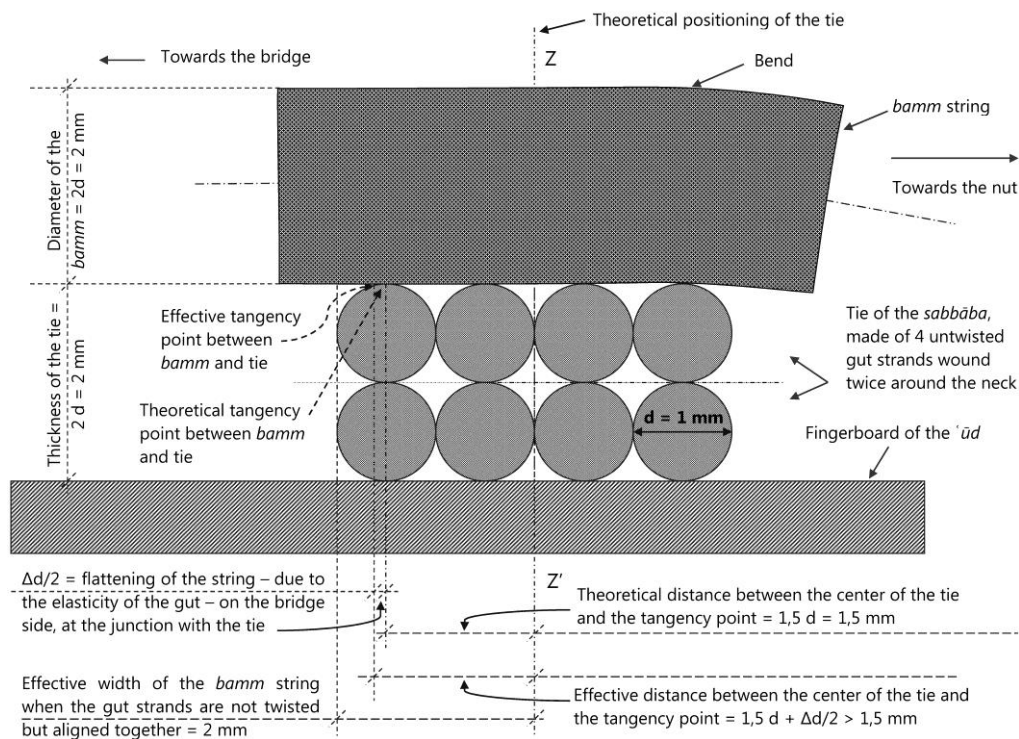

FHT 30 Tangent point of the string with the tie in the case of a lowered bridge, and in the case (as advocated by Maalouf) where gut strands are superposed. (“Tie” in the figure = “tie-fret”); Each gut is considered as homogeneous and cylindrical, in accordance with Maalouf’s indications: Richard Dumbrill – personal communication – reminds that it would not be possible to have exactly superimposed guts in the manner in which they are described in this figure. The upper row of guts would force its way in between the guts of the lower register. But moreover the guts would not be of circular section surface due to the fact that they would have needed to be wet when affixed and would be of ovoid section surface.)

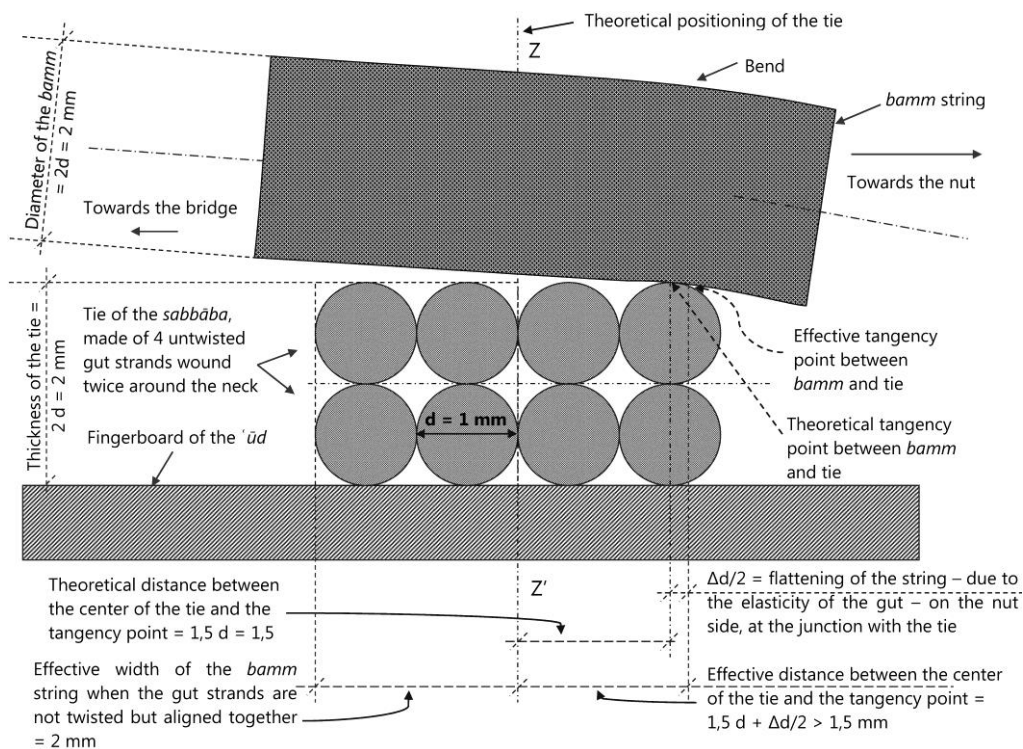

FHT 31 Tangent point of the string with the tie: as above but in the case of a heightened bridge. (“Tie” in the figure = “tie-fret”).

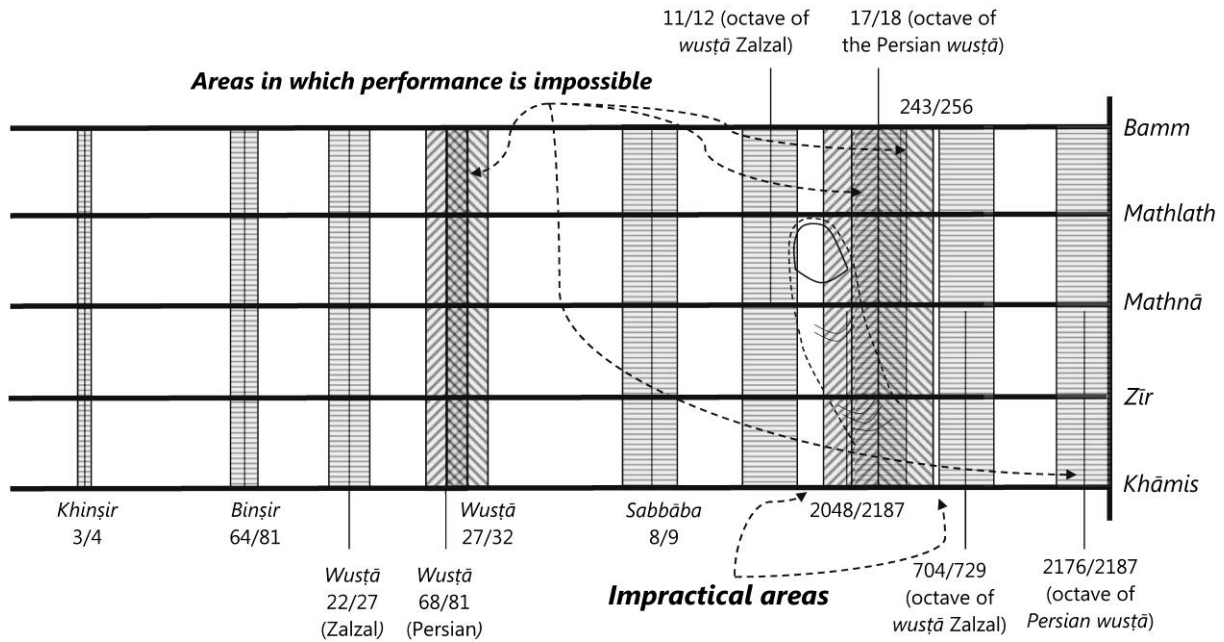

FHT 32 Fārābī’s division as described by Maalouf (and advocated by Abou Mrad) with overlapping (or very close one to another) “frets” in case tie-frets are winded around the neck of the ‘ūd following Kindī’s indications. Performance is practically impossible in this case.⁴¹⁴

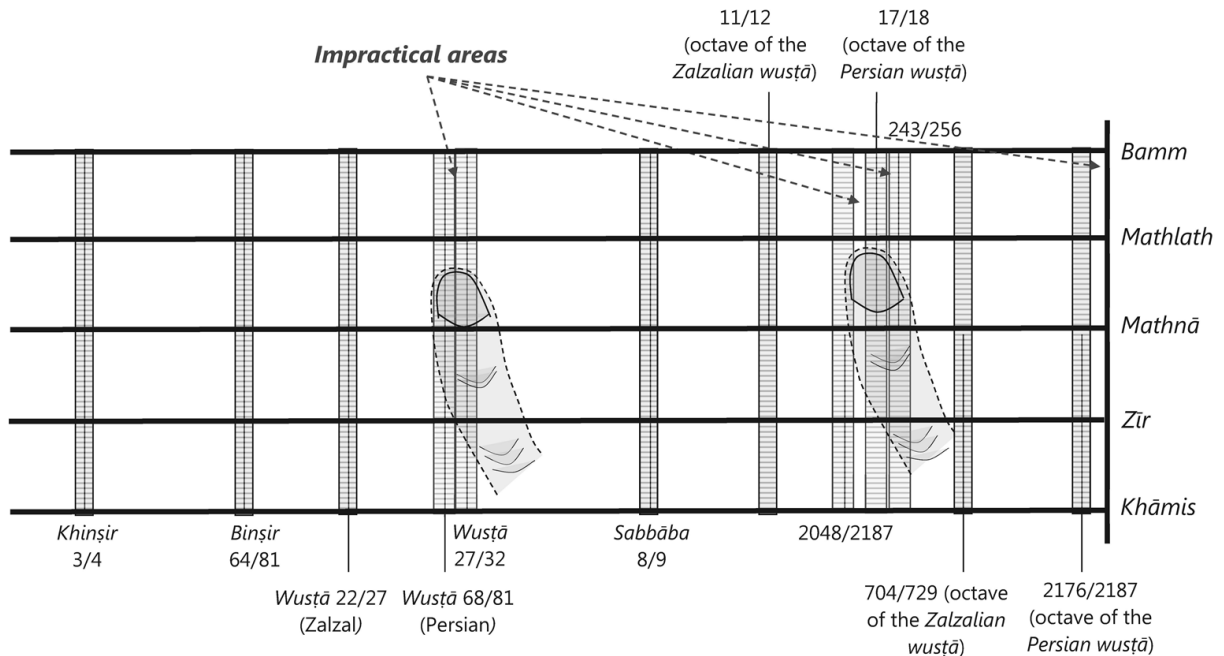

FHT 33 Fārābī’s division as described by Maalouf (and advocated by Abou Mrad) with overlapping (or very close one to another) “frets” in case “realistic” tie-frets (thickness is taken as equal to $2 \times 1\text{mm}$) are mounted on the neck of the ‘ūd. More impractical areas appear while one zone of (nearly) impossible performance remains for the plain (27/32) and Persian (68/81) *wustā*(s).⁴¹⁵

⁴¹⁴ Translated and adapted from [Beyhom, 2010b, v. 1, p. 358].

⁴¹⁵ Adapted and translated from [Beyhom, 2010b, v. 1, p. 358].

APPENDIX C: THE *RISĀLA FĪ-L-MŪSĪQĀ* BY (AL-) MUNAJJIM (856-912)

The first extant theoretical (and historical) divisions of the neck of the *ūd* are, as explained in the main text, by Kindī and Munajjim.⁴¹⁶ While previous reviews of Arabian theories assert, with a little haste it seems, that these divisions are Pythagorean and ditonic,⁴¹⁷ and based on the tuning of the strings of the instrument in successive fourths,⁴¹⁸ things do not stand however in such a simple fashion.

The manuscripts of these authors are not explicit about this information and, while Kindī proposes an alternate harmonic division – which is far from Pythagoreanism –, Munajjim’s alleged “Pythagorean” division, even if it were possible – if not probable – must still be sustained.⁴¹⁹

* * *

Yaḥyā ibn ‘Alī ibn Yaḥyā ibn abī Maṣṣūr al-Munajjim comes from a family of astrologists,⁴²⁰ of poets and of historians. He was close to al-Muwaffaq, the brother of Caliph al-Mu‘tamid (870-892),⁴²¹ and he is known

⁴¹⁶ Please note here that by “division” I mean a theoretical mesh of the neck which *could* have been materialized by the strings, on one side, and by – perpendicular to the strings – drawn lines, or by threads tied on the fingerboard of the instrument, on the other side. The controversial – and very rare – descriptions of physical “ligatures” (or “tie-frets”) are examined in Part II of this dossier.

⁴¹⁷ This is the Pythagorean ascending-descending division shown in FHT 13 in [Beyhom, 2016, p. 186].

⁴¹⁸ (Reminder:) The *ūd* at that time had 4 strings, named consecutively (from top to bottom – for a *ūd* played by a right-handed performer and seen from the front side – but “lowest” to “highest” acoustically) *bamm*, *mathlath*, *mathnā* and *zīr*; the *ḥād* (an additional string situated lowest – and acoustically “highest”) is cited in Urmawī’s *al-sh-Sharafiyya*, while several earlier authors (including Kindī – who names it the “lower *zīr*” in the *Risāla fī Khubr Sīnā‘at al-Ta‘līf*) mention this 5th string although they specify that its use (fullness) was merely theoretical.

⁴¹⁹ The following section contains a few, simple algebraic formulae for Munajjim’s division of the fingerboard of the *ūd*. An accessible review of algebra is available in [Pratt, 2007].

⁴²⁰ Besides [Beyhom, 2010b], Owen Wright’s articles [1966; 2001i] can be consulted for additional information about Munajjim and his epistle. “Munajjim” (root: *n[aljm]* – “planet”, “celestial body”) in Arabic means “astrologist”.

⁴²¹ [Farmer, 1929, p. 167].

⁴²² [Farmer, 1929, p. 168] and Erlanger in [Fārābī (al-), 1930, v. 1, p. xxii].

⁴²³ Including anecdotes, stories and poetry from the time of the *Jāhiliyya* (the period before Islam – the religion – or “the time [or

through one epistle on astronomy and one other on astrology, and would have written (at least) two works on music, one of which – one about singing (*ghinā’*) – is lost.⁴²²

The other epistle, the *Risāla fī-l-Mūsīqā*, is considered by some commentators as the key for the comprehension of a voluminous compendium of anecdotes and songs of the 10th century,⁴²³ the *Kitāb al-Aghānī*⁴²⁴ by Abū-l-Faraj ‘Alī al-Aṣṣfahānī (or Iṣṣfahānī).⁴²⁵

This epistle brought numerous analyses and interpretations.⁴²⁶ Munajjim claims in the introduction⁴²⁷ that he would explain the teaching of Iṣṣhāq al-Mawṣilī,⁴²⁸ but this task is not really fulfilled as not only later (contemporary) commentators would not agree on the structure of the modes mentioned by him, but also because even the structure of his division cannot be proven with the extant data.

The naming system (literal notation) is alphabetic, and uses the same Syriac alphabet as with Kindī (*abjad*) for the ten named notes, beginning from the unstopped *mathnā* string (FHT 35:186) and ending on the *zīr* string for the last one (produced by a shift of the hand position). The exact placement of the “last note” remains conjectural.⁴²⁹

Era] of ignorance” – see footnotes no. 45:119 and 226:142) till the 10th century.

⁴²⁴ See a short description in [Sawa, 2001]. Most other writings of Sawa relate to this period of Arabian music theory and practice and could be relevant for the reader seeking additional comments, for example [Sawa, 1981; 1985; 1989; 2002].

⁴²⁵ The title of Yūsuf Shawqī’s 1976 edition, *Risāla’ ibn al-Munajjim fī-l-Mūsīqā wa Kashf Rumūz Kitāb al-Aghānī* [The epistle of ibn al-Munajjim on music and the unveiling of the symbols of Kitāb al-Aghānī], is for example explicit about this matter. Abū-l-Faraj al-Aṣṣfahānī (or Iṣṣfahānī, 897–967) a.k.a. Abulfaraj, “was an historian of Arab-Quraysh origin who is noted for collecting and preserving ancient Arabic lyrics and poems in his major work, the *Kitāb al-Aghānī*. [He] was born in Isfahan, but spent his youth and had his early studies in Baghdad. He was a direct descendant of the last of the Umayyad caliphs, Marwan II, and was thus connected with the Umayyad rulers in al-Andalus, and seems to have kept up a correspondence with them and to have sent them some of his works. He became famous for his knowledge of early Arabian antiquities” – [Wikipedia Contributors, 2017c] (see also [Neubauer, 2001c]).

⁴²⁶ For a review of these interpretations, see [Sawa, 1989, p. 74–78].

⁴²⁷ [Munajjim (al-), 1976, p. 189].

⁴²⁸ See footnote no. 101:101.

⁴²⁹ There are contradictory statements in the epistle about the “10th [last] note” – see [Beyhom, 2010b] and [Wright, 1966] for more details.

Each note of the lower octave corresponds to the starting point of a mode, with courses (*majāri* – sing. *majrā*) running through (either of) the *biṣīr* (annular) or the *wuṣṭā* (middle finger).⁴³⁰

No mention is made of the tuning of the strings, or of intervals. Furthermore, the drawing that Munajjim mentions for the division of the fingerboard of the instrument is missing in both copies. The division can however be reconstructed – assuming the tuning of the ‘ūd is a variable – using indications about correspondences of octaves (or unisons – FHT 36:186). If – and only if – the tuning is in consecutive just fourths (FHT 38:187)⁴³¹, the division becomes Pythagorean (ascending, with one descending tone from the *khinṣir*), but there is an infinity (as for infinite steps) of other possible divisions (FHT 36:186 and FHT 34:185), including an infinity of Zalzalian divisions.⁴³² No other indications in the epistle allow for more precision or provide more information about the division.⁴³³

FURTHER EXPLANATIONS ABOUT FHT 34:185 TO FHT 38:187

The equivalences Munajjim provides allow for the establishment of relationships between positions of the vertical markers of the four fingers,⁴³⁴ the interval between the nut and the *sabbāba*⁴³⁵ (X in the drawing, in semi-tones) being equal to the interval between the *sabbāba* and the *biṣīr* and between the *wuṣṭā* and the *khinṣir*. If we name Y the distance between the *biṣīr* and the *khinṣir*, W the distance between the nut and the *wuṣṭā*, Z the distance between the nut and the *khinṣir*, and with O being the octave (12 tempered semi-tones), inter-relationships can be deduced in the form of the following algebraic relations:

⁴³⁰ These “courses” in [the ligature (*dastān*) of] the *wuṣṭā* or of the *biṣīr* correspond to successions of notes composing a modal scale, starting with a particular note and making its way through either the *biṣīr* or the *wuṣṭā* – see [Beyhom, 2010b] and [Wright, 1966] for more details.

⁴³¹ “The organization, or at least the classification, of the modal system of Umayyad and early Abbasid music seems [...] to have been influenced by the recently formulated Byzantine *Oktōechos*. Some features of the Arab system, which likewise consisted of eight modes, are described by al-Munajjim (856–912), who discussed them in terms of the diatonic fretting, to which their names relate, on the two upper strings of the ‘ūd. Assuming a tuning in perfect 4th, the fretting yields a series of intervals consisting of the Pythagorean whole tone (T) of 204 cents, the *limma* (L) of 90 cents and (by subtraction) the *apotome* (A) of 114 cents” – Wright in [Wright, Poché, and Shiloah, 2001, p. 800–801]. (Bold type mine)

$$5X + 2Y = O \text{ (“octave”),}$$

$$\text{with } 0 \text{ (“zero”) } \leq Y \leq X \leq O/2 ; Z = 2X + Y ; W = X + Y$$

or, for X and Y expressed as functions of one another:

$$Y = 6 - \frac{5X}{2}, \text{ with } 0 \leq Y \leq X \leq 6;$$

$$X = \frac{12 - 2Y}{5}, \text{ with } 0 \leq Y \leq X \leq 6$$

An example for function “ Y ” above depending on the evolution of “ X ” is provided in FHT 34, and the general case with interval boundaries is shown in FHT 37:187. Note that when $X = 2,04$ (slightly augmented Pythagorean tone), $Y = 0,9$ (*leimma*). This is one out of an infinite number of solutions, which depend on the precision of the measurement of X and Y .

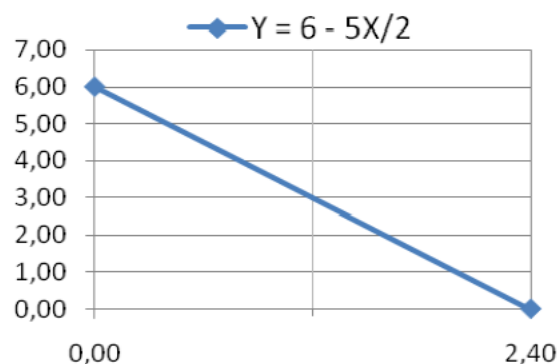

FHT 34 Graphic showing the relation between Y (vertical axis – interval between the *biṣīr* – annular – and the *khinṣir* – auricular) and X (horizontal axis – interval between the nut and the *sabbāba* [index] – and between the *sabbāba* and the *biṣīr*). When $X = 0$, $Y = 6$ (semi-tones); when $X = 2,4$, $Y = 0$ (or *vice versa*). The general case with boundaries for each interval in shown in FHT 37:187. When $X = 2,04$ (Pythagorean tone), $Y = 0,9$ (*leimma*) and the division becomes Pythagorean (FHT 38:187).

⁴³² Although these are unlikely, with regards the context – see for example, on the same subject, [Wright, 1966, p. 45, fn. 7]: “Even if we ignore the evidence of the early theorists, [the tuning of the ‘ūd in Munajjim’s epistle, in perfect fourths] is corroborated by Al-Khawārizmī (*Maḥāṭib al-‘Ulūm*, ed. van Vloten, p. 239), speaking specifically of musical practice”.

⁴³³ We find in the epistle: “the reason for this disposition of the ligatures is a discussion which exceed the limits of this epistle [*kalām yaṭūl al-kitāb b-istifā’ihī*]” – [Munajjim (al-), 1976, p. 221].

⁴³⁴ Detailed explanations on how the formulae were established and on alternative solutions are available in [Beyhom, 2010b, v. 1, p. 581–589].

⁴³⁵ Reminder: *sabbāba* for the index, *wuṣṭā* for the middle finger, *biṣīr* for the annular and *khinṣir* for the auricular.

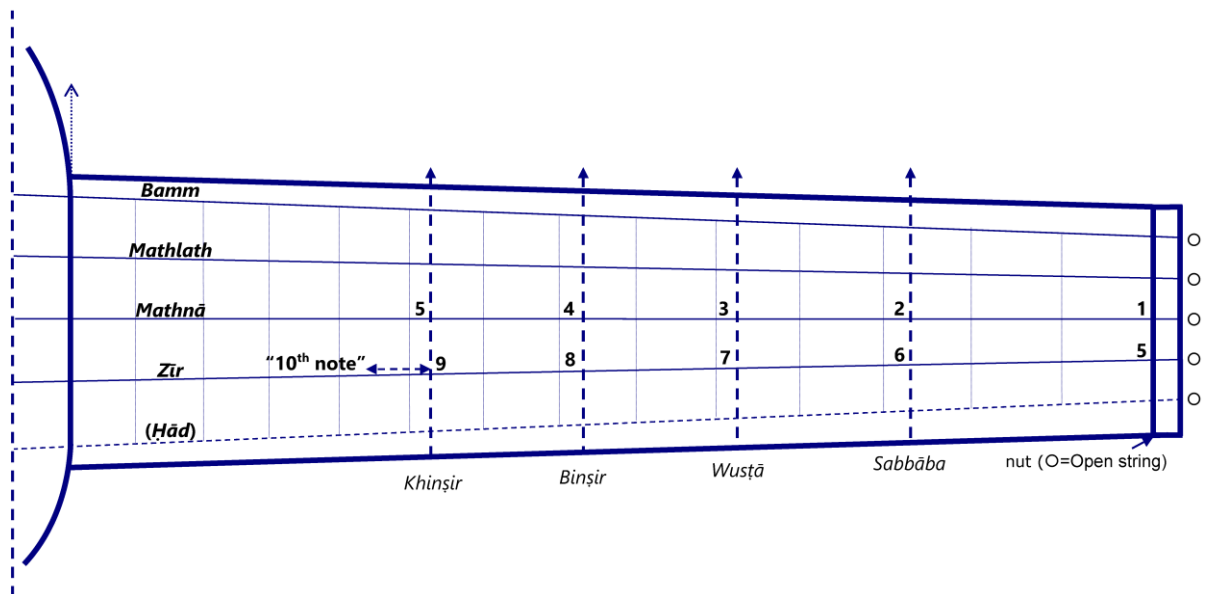

FHT 35 Stylized fingerboard of a ‘ūd showing the sequential assignment of the 10 notes by Munajjim in his *Risāla fī-l-Mūsīqā*. The division and the position of the 10th note are still undetermined.

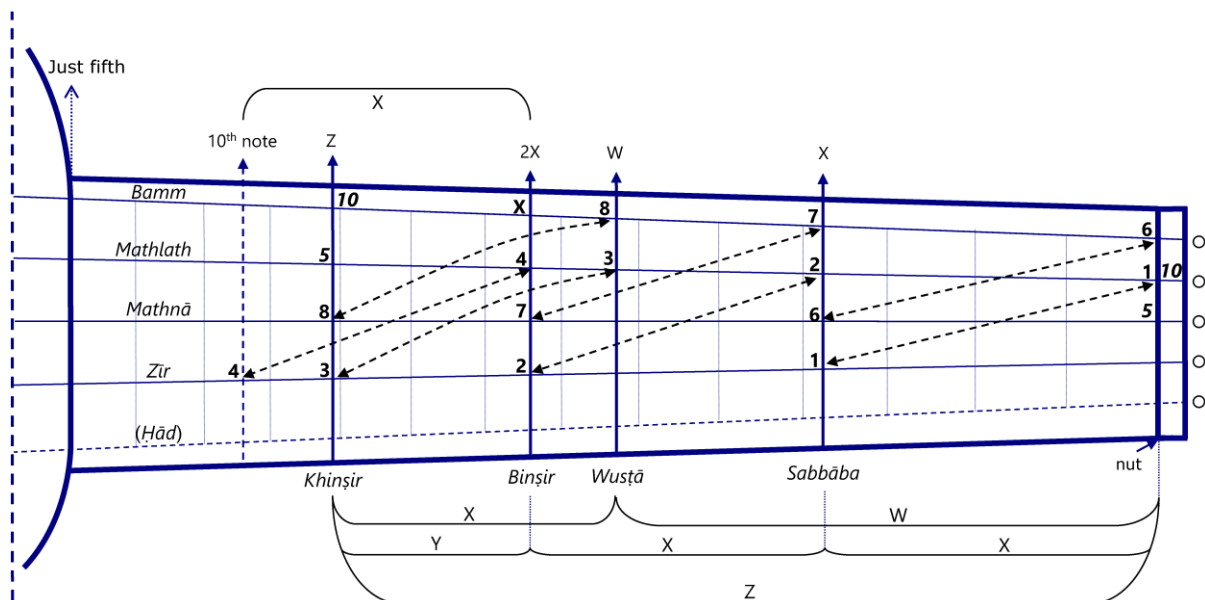

FHT 36 Stylized fingerboard of a ‘ūd with unspecified intervals corresponding to algebraic formulae deduced from the epistle of Munajjim *fī-l-Mūsīqā*. The double sided arrows show (sequentially numbered) equivalences between octaves (bold) or unisons (bold italics).

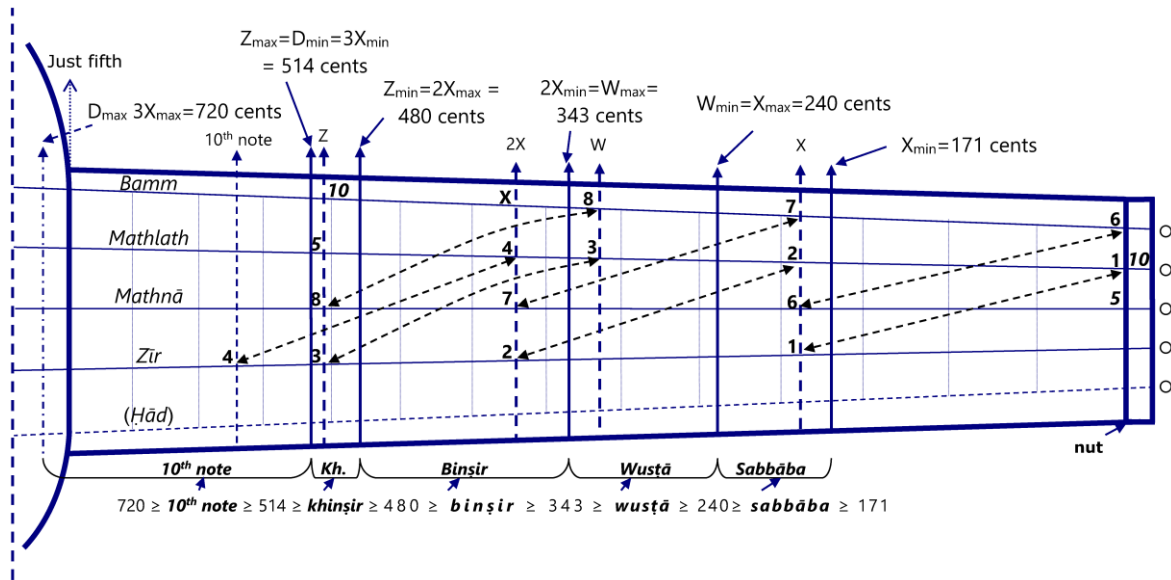

FHT 37 Calculated boundaries (in cents) of the intervals between the vertical markers for the general case, in the division of Munajjim. *D* is the interval between the nut and the “10th note”.

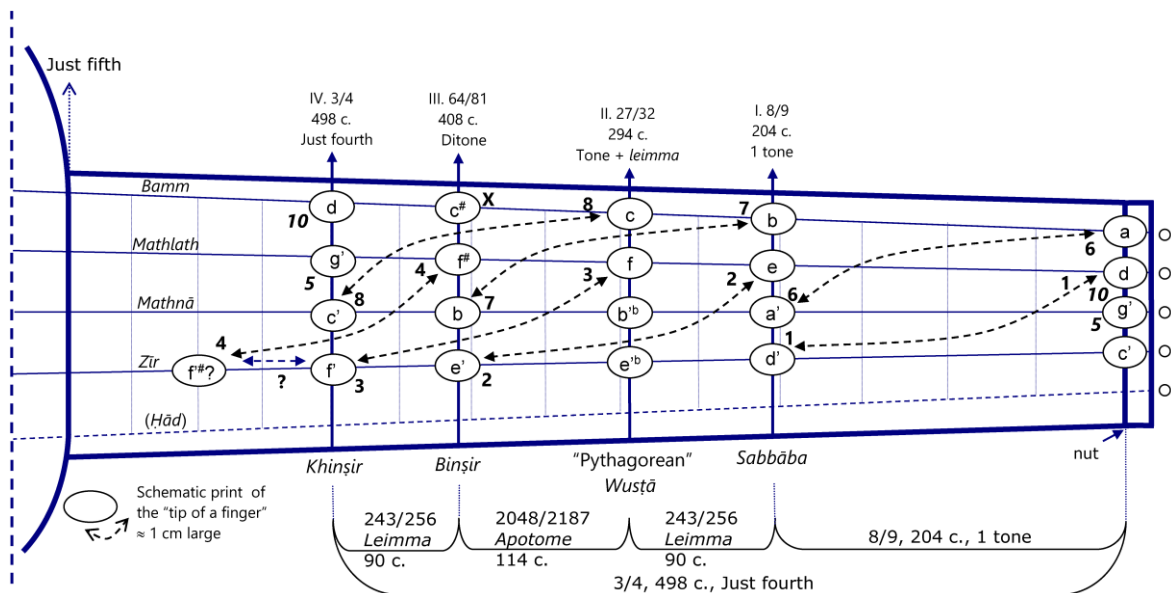

FHT 38 Stylized fingerboard of a ‘ūd with, assuming a tuning of the strings in fourths, with Munajjim’s resulting Pythagorean “ascending then descending one tone” division. (This corresponds to two ascending whole-tones then a *leimma* from the nut, to which we add a whole-tone descending from the *Khinšir* which completes the division.)

APPENDIX D: ORIGINAL TEXTS

Due to the necessity of including multiple quotes in the dossier, and to the importance of their translation for a better understanding of sometimes subtle (but effective) differences between interpretations, the original texts are included in this appendix, except for small quotes which are kept for quick reference in the main text.

* *

[Kiesewetter, 1858, p. 32]:

“Ueberhaupt kann ich mich schon lange des Gedankens nicht erwehren, dass die ausübende Musik verschiedener älterer und neuerer asiatischer Völker ein ganz anderes Ding gewesen sein oder noch sein müsse, als jene metaphysische oder mathematische Musik ihrer Philosophen, deren Theorien, ein Werk bloßer Spekulation, sich von der Praxis immer entfernt gehalten haben mussten. Ich meine, [...] dass man demzufolge nicht sagen sollte: die Musik der Chinesen, der Indier, der Araber, der Perser u. s. w., sondern: die musikalischen Systeme (oder Mysterien) der chinesischen, der indischen, arabischen, persischen Philosophen, des Meisters Chrysanthos, u. s. w. – Vielleicht dass es in der Musik der alten Griechen eben auch nicht anders gewesen”.

[Jargy and Chottin, 2001, p. 527]:

“1) *Période bédouine*, depuis la *djâhiliya* jusqu’aux premiers temps de l’Islam (mort d’Ali, 661) ; 2) *Période d’assimilation*, de la dynastie omeyyade au premier cycle Abbasside (vers 830) ; 3) *Période d’épanouissement et de dispersion*, avec le second cycle Abbasside et l’établissement des Omeyyades en Espagne ; 4) *Période de repli*, de la prise de Grenade (1492) à la fin du XVIII^e siècle ; 5) *Renaissance* : la *Nahda*, du XIX^e siècle, à partir de l’expédition de Bonaparte en Égypte, jusqu’au congrès du Caire (1932)”.

[Chabrier, 1982]:

“Avec les Califes Abbassides de l’Iraq, [le *ūd*] va devenir le luth concepteur des genres et modes des musiques méso-islamiques et créateur des mélodies, rôle qu’il conservera jusqu’à nos jours dans les musiques arabes savantes et populaires”.

[Kindī (al-), 1965, p. 19]:

“وقد يستعمل المغنون أيضاً نغمة خارجة من جميع الدساتين يسمونها “المحصورة” وهي خارج من دستان الخنصر يمدون إليها الخنصر، وخلف هذه أيضاً – بمثل مسافة دستان الخنصر – نغمة أخرى، غير أنهم ينقلون السبابة إلى دستان الوسطى أو البنصر”.

[Sinā (Ibn) or Avicenna (980?-1037), 1956, p. 47–48]:

“[...] فلما حاولوا ايداعه اللحنيات [...] ودع ثلاثة أبعاد للسبب الذي ذكرناه. وقد أعان هذا السبب سبب من جهة الآلة وهو: أن الحاجة مسّت

في تقدير النغم إلى الدساتين، واضطرت إلى أن يستعمل عليها الأصابع، وعسر في ابتداء الأمر أن يحرك الكف والأصابع معاً، ففرض على الكف السكون وعلى الأصابع الحركة، وكان القدر الذي يلزمه الكف ساكناً وتتصرف عليه الأصابع متحركة من طول الآلة المعتدلة هوربعه، فشُدَّ على الربع أول الدساتين منسوباً إلى الخنصر، وشغلت الإبهام بالضبط، وبقي للتصرف فيما بين حدّي ذلك الربع أصابع أربعة”.

[Manik, 1969, p. 12]:

“In bezug auf die Lautenbünde, die die mittelalterlichen Musiktheoretiker zur Darstellung ihrer Tonsysteme ausführlich beschrieben haben, vertritt nun Berner die Meinung, daß diese Bünde niemals bestanden haben, weil es sich hier, wie er wörtlich sagt, nur um eine “bloße Fiktion” handele. Dabei beruft sich Berner auf Geiringer, der, nachdem er festgestellt hatte, daß eine Laute mit Bündeln in dem ikonographischen Befund der Zeit nirgends anzutreffen war, zu dem Schluß gelangt, daß Bünde nur für Messungs- und Untersuchungszwecke verwendet wurden, so daß sie für die Musikpraxis keinerlei Bedeutung haben konnten. Zu ähnlicher Folgerung war auch Curt Sachs schon früher gekommen”.

[Ṭahhān (ibn a-ṭ- al-Mūsīqī), 1990, p. 175-176 (89–90)]:

“بعض الناس يظنّ أنّ النغم التي في العود مختلفة العدد اختلافاً في شدّة الدساتين ونحن نذكر من ذلك ما يتفق. وهي قانون الغناء المتبع. وتجري مجرى شدّة نفوس الحدّي وهو من أجل هذا الشّأن والدساتين حدود النغم والسنة الاوتار ومنها مخارج النغم من العود ومواضع الحروف من الحلق فإذا خرج حرف من الحلق من موضعه الحقيقي خرج صافياً وكذلك النغمة إذا خرجت على دستان صحيح خرجت صافية وجميع الدساتين التي تُستخرج فيها النغم الطبيعية للانسان وتُستعمل في جميع الالحن سِتّة دساتين أولها دستان المجنّب ودستان السبابة ودستان وسطى الفرس ودستان وسطى العرب ودستان البنصر ودستان الخنصر وبين دستانى وسطى العرب ودستان البنصر دستان آخر يسمى دستان زلزل وأكثر الناس يُهمله ودستان آخر يقع بين دستان البنصر ودستان الخنصر يُهمل أيضاً وهذه الدساتين الخارجة عن العدد الأول فهي ممّا يستعمله الفرس في طرائقهم وأنا أستعمل ذلك وأطرق مواضعه لمعرفتي به بغير دساتين وذلك يصعب على المتعلّمين فتركه لهم أولي وأحقّ. وشُدّ الدساتين يحتاج إلى علم بها. محتاج الذي يريد شدّها على العود أن يأخذ بركاراً فيفتحه فتحاً بقدر ما يريد شدّها ويقبس به قياساً صحيحاً بينها والمطبوع المرتاض العارف المرتاض يعرف أقدارها ومواقعها بلا بركار بل بالحسن ومُقابله بعض النغم ببعض وبالعادة والدربة ثم يشدّها فإذا كملت على ما ذكرناه صحّت النغم وصفت وهذه حملة كافية ولا يحتاج في عرض الدساتين أكثر من أربع طاقات من الاوتار البيض المصارين ويجب أن يكون على تدرج في أن يكون الأوّل غليظاً والثاني دون غلظه والثالث دونه كذا إلى آخرها على هذا المثال وإن لم يعتبر بالعين فليعتبر بالوزن فإنّه أصحّ”.

[Fārābī (al-) and الفارابي, 1967, p. 655]:

”وربما كانت صنعة الآلة صنعة يقتزن منها إلى نغم الدساتين المتفاضلة نغم أو دويّ يُفسد اتّفاقاتها، فيضطرّ الإنسان عند ذلك إلى استعمال الدساتين المتساوية أبعاد ما بينها، على ما قيل فيما أثبت في العود“.

[Fārābī (al-), 1967, p. 663–664]:

”فأما أكثر المجندين من مستعملي هذه الآلة من العرب، فإنهم لا يستعملون الدساتين الجاهلية، لكن يُزلون أصابعهم أسفل من دستان (س.ع)، فيجعلون دستان (س.ع) دستان السبابة، ويضعون البنصر أسفل منه إلى ناحية (ج) ويتلون بالخنصر، وآخر مكان يضعون عليه خناصرهم هو دون ربع جميع الوتر بشيء صالح القدر، ويجعلون وسطياتهم بين (س.ع) وبين أمكنة بناصرهم. وأكثرهم يجعلون أبعاد ما بين أصابعهم متساوية، أو يجعلون مسافات ما بين أصابعهم قريبة من مسافات ما بين دساتين إلا مكان السبابة، فإنهم يستعملون فيه آخر دساتين الجاهلية، وهو دستان (س.ع)“.

[Kindī (al-), 1965, p. 12–16]:

”قسمة الدساتين

أما الدستان الأول الذي تسميه الحكماء ”المفتاح“ فإنه يلي الأنف وهو الذي تقع عليه الأصبع السبابة، وهو مشترك لجميع الأوتار ولا يقع عليه من الأصابع إلا السبابة فقط، وتركيبه: أن يقدر ثلاثة أصابع من هذين الثلاثين التي هي طول الوتر – ويكون التقدير من رأس العنق الدقيق وهو موضع الأنف – فحيث انتهت الأصابع الثلاث أدير على ذلك الموضع قطعة من بم دورين اثنين، ثم يربط على ظهر العنق رباطا شديدا لا يتهيأ له لشدته أن يزول عن موضعه.

ثم يُقدر من هذا الدستان – إلى ما يلي المشط – اصبعين اثنين، ويُشدّ

//13//

على الموضع قطعة من مثلث على سبيل الدستان الأول وهذا: لدستان الوسطى [113] و] في جميع الأوتار.

ثم يقدر من ذلك اصبع واحد إلى جهة المشط ثم يُشدّ عليه دستان من مثنى على شرائط الدساتين اللذين سلفا.

ثم يقدر من هناك اصبع ونصف ويشد على الموضع قطعة من زبر على سبيل الدساتين المتقدمة، وهذه قسمة الدساتين، وأنا مبتدي بشرح علل هذه القسمة وموضح لما صارت كذلك بلا زيادة ولا نقص.

إن هذه الآلة ليس فيها شيء إلا وفيه علة فلسفية: إما هندسية وإما عددية، وإما نجومية، فأما قسمة الدساتين فإن العلة فيها عددية وذلك: انه لما كان طول الوتر ثلاثين اصبعاً كان أقلّ أجزائه المنطوق به لفظاً واحدة العُشر وهو ثلاث أصابع، فكان موضع نغمة وشدّ هنالك دستان السبابة، ولأن ما كان أقل من العشر – كجزء من أحد عشر وجزء من اثني عشر وغيرهما من الأجزاء – لا يقال له جزء مطلق معلوم لأنه لا اسم له، وإنما الاسم لفظاً واحدة كعشر وتسع وثمن إلى أن يبلغ النصف.

ثم طلبوا الجزء الذي يلي العشر لِيُشدّ في مكانه دستان فكان التسع، فلم يجدوا للثلاثين تسعاً، ولم يكن هناك موضع دستان لأن الوتر لا ينطق إلا من موضع جزء من أجزائه فجاوزه [113] و] ونظروا أيضاً إلى الثمن معدوم

من الثلاثين، وكان التسع كذلك فجاوزه. ثم طلبوا السُدس – وهو خمسة – فكان موضع النغم فشدوا فيه دستان الوسطى وهو على اصبعين من دستان السبابة وخمسة من أول الوتر.

ثم طلبوا الخُمس فوجدوه – وهو ستة – فشدوا هنالك دستان البنصر. ثم نظروا إلى موضع الرُبع الذي قدره لجملة الدساتين فشدوا عليه دستان الخنصر.

//14//

ولم تُجرأ النغم هذا الجزء من الوتر – أعني الربع – إلا لليلة التي ذكرناها: من عمق العود وحاجته إلى مساواة النغم وحاجة النغم إلى مساواته.

ثم صبروا الجزء الذي بعد الربع – وهو الثلث – حدّ العمق من جسم العود. ثم صبروا الجزء الذي بعد الثلث – وهو النصف – للعرض وهو أعرض موضعٍ يجب أن يكون فيه، ويجب أن يكون موقعه من العود على ثلاث أصابع من نهاية المشط إلى ما يلي الأوتار، والعلة في ذلك: محاذاته لضرب الأوتار، وذلك أن هذا الموضع من العود أكثره سعة وأكمله دويًا، وإنما صار مضرب الأوتار على ثلاث أصابع من المشط لأنه موضع جزء من أجزاء الوتر وهو العُشر.

وينبغي أن يكون جسمه في غاية ما يمكن [114] و] من الرقة ويكون ذلك عامًا فيه لجميع أجزائه، حتى لا يكون في ظهره موضع أرق ولا أثخن من موضع وكذلك في بطنه، فإن اختلاف أجزائه في الرقة والأثخن مما يُحيله عن استواء الأوتار واتتلاف النغم.

//15//

الفن الثاني

في معرفة الأوتار والنغم

أما الأوتار فهي أربعة، أولها: البم وهو وتر من معاء دقيق متساوي الأجزاء وليس فيه موضع أغلظ ولا أدق من موضع، ثم طوي حتى صار أربع طبقات وقتل فتلا جيدا.

وبعد: المثلث وسبيله سبيل البم غير أنه من ثلاث طبقات.

وبعد: المثنى وهو أيضًا أقل من المثلث بطبقة – وهو من طبقتين – غير أنه من ابريسم، حتى قُتل فصار في قياس الطبقتين من المعاء في الغلظ.

وبعد: الزبر وهو أيضًا أقل من المثنى بطبقة واحدة – وهي أن يكون من طبقة واحدة – وهو من ابريسم في حال طبقة من طبقات الأمعاء.

فجعل البم أربع طبقات لأنه أساس لأوائل النغم وهي النغم الكبار الخارجة من أوسع موضع في الحنجرة – وهو أصل قصبه الرثة – ولذلك يجب إذا غلّق البم في موضعه – الذي هو أعلى مواضع الأوتار – أن يُمد ملواه ويترنم بهذه النغمة – أعني أول نغمة في [114] ظل أصل الحنجرة، ويُحرك البم بإبهام اليد اليمنى، فإذا استوى مع تلك النغمة فأوقفه على ذلك المد فإنها مرتبته في التسوية. وإنما جعلته الحكماء على هذه السبيل من غلظ الجسم ليساوي هذه النغمة الغليظة في الحنجرة.

ثم تتراقب النغم في الأوتار كتراقبها في الحنجرة نغمة بنغمة حتى تصير إلى أدقها في الأوتار، ولذلك صار المثلث أقل من البم في الغلظ لأن النغم إذا

تراقت في الحنجرة دقت واحتاجت من الأوتار إلى نغمٍ دفاقٍ لمقايستها، ولهذه العلة أيضًا صار المثنى أقل من المثلث، والزرير أقل من المثنى.

//16//

فأما لم صار المثنى والزرير ابريسم دون البيم والمثلث؟ فإن ذلك لعلتين، إحداهما: إن النغم إذا تراقت حتى تصير من الدقة إلى مثل حالها في المثنى والزرير احتاجت إلى صفاء طنين الابريسيم [الذي] إذا مُدَّ كان أصفى طنينًا من المعاء. والعلة الثانية: إن الوتر في هذا الموضوع يحتاج من المد لتقوم نغمته وتثقيفها إلى ما لا تقوى عليه طبقة واحدة من المعاء الدقيق ولا طبقتان، فكان الابريسيم إذا صُبِّر بقياس ذلك المعاء في الغلط قوي على ما يحتاج إليه من المد دون المعاء.

[Fārābī (al-), 1967, p. 580–583]:

“والبقية هي قريبة من ربع طنيني، فلذلك قد يوجد لها اتفاق قريب من اتفاق ربع طنيني، وإنما يلحقها ذلك بسبب أن القسمة ليست تبلغ إلى أن يكون طرف المفصول متناهياً إلى حقيقة الموضوع الذي منه تخرج النغمة المقصودة، لكن، ربما حاد إلى أزيد أو أنقص. فإن كان المقصود ربع طنيني، فزال عن موضع القسمة فزاد زيادة يسيرة، صار بقية فلم يسمع له اتفاق أصلاً. وإن كان المقصود بعد بقية وزال عن موضع القسمة فنقص نقصاناً يسيراً أمال البقية إلى ربع طنيني سمع لها اتفاق ما [...] فلذلك صار يعسر علينا الحكم في البقيات التي في العود، إنها غير متلائمة النغم.”

[Fārābī (al-), 1967, p. 516]:

“[...] غير أنه ليس في تكثير الدساتين كبير غناء. وكثير من الناس يستعملون نغمًا غير هذه بحسب حاجاتهم إليها في تميم الطرائق التي يستعملونها أو في ترتيبها، من غير أن يكون لتلك النغم أمكنة محدودة، فبعض تلك النغم يستخرج فيما بين الدساتين وبعضها يستخرج أسفل دستان الخنصر وبعضها فوق دستان السبابة، ويُقصد باستخراجها أن تعزز النغم. ومتى أحب إنسان أن يعرف تلك النغم، فالوجه في ذلك أن يطلب ملائمتها في الأمكنة المعروفة، إما على الدساتين أو في أمكنة أحر.”

[Sīnā (Ibn) or Avicenna (980?-1037), 1956, p. 140]:

“والتوصيلات - وهي أيضًا من جنس التمزيجات، أو مقارنة لها - وهو: أن تنقر دستان، ثم تحرك الإصبع إلى دستان فوّه أو تحته على الاتصال، إرادة لإن تغير الصوت من حدة إلى ثقل، أو ثقل إلى حدة، تغيراً على الاتصال.”

[Zayla (ibn), 1964, p. 76]:

“[...] فلأن المشط إذا كان مرتفعًا - أو الأتف - حتى صار ذلك سببًا لتباعد وضع الوتر عن وجه الآلة، فإذا قبض الوتر إلى شد الدستان حتى يلتصق بوجه الآلة، احتاج ضرورة إلى أن يتمدد، والسبب في ذلك: أنه قد كان قبل خطأً مستقيمًا واحدًا، والآن نريد أن يصير خطين يحيطان بالخط الأول لو ثبت بمثلث، وكل ضلعين مجموعين من المثلث أطول من الثالث، ولن يطول الوتر إلا بفضل تمدد، والتمدد يغير الطبقة إلى الحدة.”

[Lādhiqī (al-), 1986b, p. 179]:

“وبعض العملة المتأخرين يشدون على ساعد تلك الآلة وترًا سادسا ويسمونها عود أكمل وقد وضع على سواعد تلك الآلات علامات دالة على مخارج نغمات مدار اللحن من تلك السواعد ويسمى تلك العلامات بالدساتين سواء كانت أوتارًا مشدودة أو خطوطًا مكتوبة وغيرها.”

Neubauer's German translation of the latter in [Neubauer, 1993, p. 328]:

“Man bringt (*qad wuḍī'a*) auf dem Hals dieser Instrumente [d.h. der Lauten] Zeichen (*alāmāt*), die die Ausgangsorte der Töne auf dem Griffbrett bezeichnen, in denen sich die Melodien bewegen (*makhārīju naḡhamāti madārī l-alḥān min tilka s-sawā'id*). Man nennt (*wa-yusammā*) diese Zeichen Bünde (*dasātīn*), ob sie nun [aus] Saiten [bestehen], die [um den Hals] gebunden werden (*awtār mashdūda*), aus Linien, die [darauf] gezeichnet sind (*khuṭūṭ maktūba*), oder aus anderem”.

[Neubauer, 1993, p. 328]:

“Die Bünde (*dasātīn*) bestehen aus einer Reihe von Zeichen (*neṣānī-ye čand*), die man auf den Hälsen (*sawā'ed*) der Saiteninstrumente (*ālāt-e dawāt-e outār*) anzubringen pflegt (*wad' karde*) zum festen [und sicheren] Aufsetzen (*tašaddod*) der Finger auf die Saite und zum Hervorbringen der Töne (*estehṛāḡ-e naḡamāt*) auf ihr”. (Bold font is used here for Persian terms.)

[Fārābī (al-), 1967, p. 498–499]:

“وهذه الآلة، من الآلات التي تحدث فيها النغم بقسمة الأوتار الموضوعية فيها وتُشدُّ على المكان المستدق منها دساتين تحت الأوتار تحدّد أقسامها التي تُسمع منها النغم فتقوم لها تلك مقام حوامل الأوتار، وتُجعل موازية لقاعدة الآلة التي تسمى المشط.”

[Neubauer, 1993, p. 329]:

“An anderer Stelle sagt er, daß Töne, die oberhalb der Bünde liegen, ohne zusätzliche Bünde nur von Meistern der Zunft gespielt werden können”.

[Neubauer, 1993, p. 329]:

“Bei einer Quintstimmung der Saiten können beispielsweise die Quinten nur hervorgebracht werden, ‘wenn sich dort ein Bund befindet, sonst nicht. Es sei dem, es gelingt [dem Spieler], den Finger [korrekt] dahin zu setzen”.

[Fārābī (al-), 1967, p. 600]:

“وفي هذه التسوية، فإن نغم كل واحدٍ من الأوتار الثلاثة، التي هي أسفل من البيم، ترتفع فوق الدستان الذي كانت تُسمع منه في التسوية المشهورة ببعده طنيني، فإن صادفت عنده دستانًا خرجت فيه وإلا لم تخرج، أو يتفق أن يقع عليه إصبع.”

Erlanger translates (in [Fārābī (al-), 1930, v. 1, p. 208]) the quote above thus:

“Dans cet accord à la quinte [entre la corde la plus grave et la suivante], les notes que produisaient les trois cordes à la suite de la première dans l'accord à la quarte, se trouvent déplacées au-dessus de leurs touches vers le grave, de la distance d'un ton.

Les points fournissant certaines de ces notes **coïncident** avec des ligatures sur lesquelles on les produit. D'autres ne **coïncident** pas avec une ligature et ne peuvent être produites, à moins qu'on ait la chance de placer le doigt au point juste". (Bold type mine.)

[Neubauer, 1993, p. 330]:

“Nach den von ihm tradierten Anweisungen verhalten sich die Saitenstärken von der *zir-* zur *bamm*-Saite wie 1:2:3:4. Analog müßte der Umfang der Bünde vom Zeigefinger- bis zum Kleinfinger- bund im Verhältnis 4:3:2:1 abnehmen. **Beides ist unrealistisch**". (Bold type mine.)

[Neubauer, 1993, p. 331–332]:

“Im Zusammenhang mit dem Stimmen der Saiten gibt al-Kindi eine Anweisung für die richtige Haltung der Finger auf den, wie al-Hindi (6./12. Jh.) sagen wird, ‘Bünden für die Fingerkuppen’: ‘Der kleine Finger wird auf die *bamm*-Saite gelegt und mit festem Griff gegen den *Kleinfinger*-Bund gedrückt, ohne sich von der Stelle zu bewegen, für die er vorgesehen ist, und indem er nach einer Seite die Saite frei [schwingen] läßt, denn [sonst] ergibt sich zwangsläufig eine Trübung der Töne. Der kleine Finger soll jeweils am Anfang der Bünde, direkt hinter ihnen, liegen, während die übrigen [Finger sich] in der Luft zwischen dem Kleinfinger- und dem Ringfinger-Bund [befinden]. [Diesen Punkt] überschreite [d]er [kleine Finger] nicht und bleibe auch nicht hinter ihm zurück, dem wenn er ihn [nur] ein wenig überschreitet [und auf den Bund gerät], entsteht im Ton eine Taubheit, und wenn er hinter ihm zurückbleibt und zwischen die beiden Bünde zu liegen kommt, entsteht ein *Zirpen*. Dies ist ein allgemein gültiges Gesetz, das für alle Finger gilt bei ihrer Bewegung über die Saiten hin und bei allen Bünden für denjenigen, der der Sache auf den Grund geht.’ Dies ‘allgemein gültige Gesetz’ und die Beschreibung der korrekten Position der Finger der linken Hand gilt bis heute und stellt der präzisen Beobachtung und Formulierung al-Kindi’s bzw. seiner Quelle ein hervorragendes Zeugnis aus. Auch der letzte Zweifel am praktischen Gebrauch der Bünde dürfte hiermit ausgeräumt sein”.

[Neubauer, 1993, p. 331]:

“... ‘Es gibt noch einen Bund, der zwischen dem ‘Ringfinger’- und dem ‘Kleinfinger’-Bund liegt, [aber] der wird [normalerweise] auch nicht gebraucht. Dieses [?] sind Bünde, die aus der ursprünglichen Zahl [sechs] herausfallen. Sie werden von den Persern in ihren Modi verwendet. Ich benutze sie **auch** und treffe ihre [richtigen] Stellen [auf dem Griffbrett], da ich sie kenne, auch ohne [zusätzliche] Bünde. Den Schülern fällt das aber schwer. **Sie fortzulassen ist [daher] besser und richtiger.**’ Hieraus folgt, daß ein ägyptischer Hofmusiker des 5./11. Jahrhunderts auch persische Musik zu Gehör brachte und daß er sie auf seiner einheimischen Laute mit oder ohne zusätzliche Bünde spielte. Daß er die zusätzlichen Bünde und damit das persische Repertoire für Anfänger des Lautenspiels lieber vermied, ist verständlich. Das heute zu hörende Argument jedoch, daß es generell nicht möglich war, auf einer

Laute mit Bünden auch Zwischentöne darzustellen, und daß man aus diesem Grund die Bünde im Laufe der Zeit abgeschafft habe, ist in dieser Ausschließlichkeit nicht zutreffend. Auch sollte die zählbeige Vorstellung, Bünde seien in der arabisch-islamischen Musikgeschichte lediglich zu theoretischem Gebrauch, nicht aber in der Praxis verwendet worden, nunmehr der Vergangenheit angehören”.

[Tahhān (ibn a-ṭ-~ al-Mūsīqī), 1990, p. 175]:

“وبين دستاني وسطى العرب ودستان البنصر دستان آخر يسى دستان زلزل وأكثر الناس يُهمله ودستان آخر يقع بين دستان البنصر ودستان الخنصر يُهمل أيضاً وهذه الدساتين الخارجة عن العدد الأول فهي مما يستعمله الفرس في طرائقهم وأنا أستعمل ذلك وأطرق مواضعه لمعرفتي به بغير دساتين وذلك يصعب على المتعلمين فتركه لهم أولى وأحق”.

[Fārābī (al-), 1930, v. 1, p. 2]:

“Pour être un parfait théoricien, quelle que soit la science dont il s’agit, il faut trois conditions : En bien connaître tous les principes. Avoir la faculté de déduire les conséquences nécessaires de ces principes dans les *êtres* (les données) qui appartiennent à cette science. Savoir répondre aux théories erronées, et analyser le vrai du faux et redresser les erreurs”.

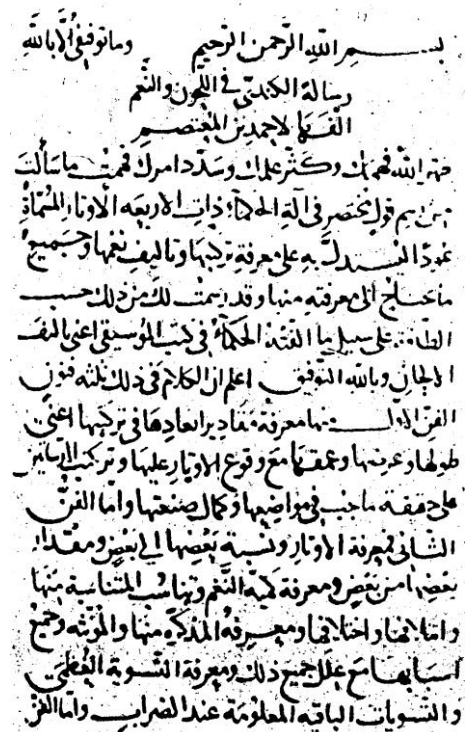

FHT 39 First page of the *Risāla fi-l-Luḥūn wa-n-Nagham* (*Mukhtaṣar al-Mūsīqā fi Ta'rif a-n-Nagham wa Ṣin'at al-‘ūd*) by Ya'qūb ibn Ishāq al-Kindi, taken from [Kindi (al-), 1965].⁴³⁶

⁴³⁶ The image was edited and cropped for clarity.

References

- Please note that “Grove Music Online” stands for “The New Grove Dictionary of Music and Musicians”, 2nd Edition [2001], online version [2001-2020], originally McMillan then [2004⁺] Oxford University Press. [<https://www.oxfordmusiconline.com/grove-music/>]
1. ABBOTT, D. and E. SEGERMAN : “Gut strings”, *Early Music* 4 4 [1976] p. 430–437.
 2. ABOU MRAD, Nidaa : “Échelles mélodiques et identité culturelle en Orient arabe”, *Musiques et Cultures Vol. III/V*, ed. Jean-Jacques Nattiez, *Musiques: une encyclopédie pour le XX^e siècle*, Actes Sud / Cité de la musique | Arles (Bouches-du-Rhône) ; [Paris], 2005 | p. 756–795.
 3. ADAMSON, Peter : “Al-Kindi”, *Stanford Encyclopedia of Philosophy* [2011] [url: <http://plato.stanford.edu/entries/al-kindi/>].
 4. Anon. “Age of Caliphs.png (Image PNG, 684 × 347 pixels)” [url: https://upload.wikimedia.org/wikipedia/commons/2/20/Age_of_Caliphs.png].
 5. Anon. “Mike Ouds - My Ouds Page” [url: <http://www.mikeouds.com/oudpics.php>].
 6. ANONYME : *A-sh-Shajara Dhāt al-Akmām al-Ḥāwīya li-Uṣūl al-Anghām [The tree with caryxes which contains the origins of the melodies]*, editors Ghaṭṭās ‘Abd-al-Malik Khashaba (عطلس عبد الملك خشبة) and Isis Faṭḥ-al-Lāh (إيزيس فتح الله), Al-Hay’a al-Miṣriyya al-‘Āmma li-l-Kitāb (الهيئة المصرية العامة للكتاب) | Le Caire, 1983-xiv^e siècle].
 7. BEG, M. A. J. : “Ṭaḥḥān (a)”, *Encyclopaedia of Islam*, Second Edition : Brill Online”, [*Print Version: Volume X, page 102, column 1*] [2000] [url: <http://www.brillonline.nl/>].
 8. BERNER, Alfred : *Studien zur arabischen Musik auf Grund der gegenwärtigen Theorie und Praxis in Ägypten. - Leipzig: Kistner & Siegel 1937. VI, 124 S. 4⁽⁸⁾ zugleich Berlin, phil. Diss. (Schriftenreihe d. Staatl. Inst. f. Deutsche Musikforschung. 2.)*, Fr. Kistner & C. F.W. Siegel | Leipzig, 1937].
 9. BEYHOM, Amine : *Systématique modale – En 3 volumes*, PhD Thesis, Université Paris Sorbonne [2003-9-17] [url: <http://www.sudoc.fr/075767538>, <http://foredofico.org/CERMAA/publications/publications-on-the-site/publications-amine-beyhom>].
 10. BEYHOM, Amine : “Systématique modale : génération et classement d’échelles modales”, *Musurgia XI* 4 [2004-12] [url: http://foredofico.org/CERMAA/wp-content/uploads/2017/11/Beyhom-2004-Systématique-modale-intro-appendices-Musurgia-XI-4-2004_OCR.pdf] p. 55–68.
 11. BEYHOM, Amine : “Approche systématique de la musique arabe : genres et degrés système”, *De la théorie à l’Art de l’improvisation : analyse de performances et modélisation musicale*, ed. Mondher Ayari, Delatour | Paris, 2005-12] [url: http://foredofico.org/CERMAA/wp-content/uploads/2017/11/Beyhom_2005_Genres_et_échelle_système_Delatour.pdf] p. 65–114.
 12. BEYHOM, Amine : “A new hypothesis on the elaboration of heptatonic scales and their origins”, *ICONEA 2008*, Lulu on behalf of ICONEA PUBLICATIONS, LONDON-UK [London, 2010a] [url: <http://foredofico.org/CERMAA/wp-content/uploads/2017/11/ICONEA-2008-2010-Hypothesis-Beyhom-complete.pdf>] p. 151–209.
 13. BEYHOM, Amine : *Théories de l’échelle et pratiques mélodiques chez les Arabes – Volume 1 : L’échelle générale et les genres – Tome 1 : Théories gréco-arabes de Kindī (IX^e siècle) à Ṭūsī (XIII^e siècle) 1/4 (vols.)*, Librairie orientaliste Paul Geuthner | Paris, 2010b-11].
 14. BEYHOM, Amine : “Two persistent misapprehensions about the ‘ūd”, *The Oud from its Sumerian Origins to Modern Times ICONEA 2011 – 1-3 December 2011*, ed. Richard Dumbrell and Irving Finkel, ICONEA Publications | University of London – Senate House, 2011-12-3] [url: <http://foredofico.org/CERMAA/wp-content/uploads/2017/01/Amine-Beyhom-Two-common-errors-about-the-‘ūd-from-iconea2011web.pdf>] p. 81–110.
 15. BEYHOM, Amine : *Théories et pratiques de l’échelle dans le chant byzantin arabe : Une approche comparative et analytique proposant une solution inédite pour le système théorique de Chrysanthos le Macdyte*, par l’auteur | Broummana (Liban), 2015-9].
 16. BEYHOM, Amine : “Dossier: Hellenism as an Analytical tool for Occidentism (in musicology) (V2)”, *Near Eastern Musicology Online* 3 5 [2016-11] [url: [http://nemo-online.org/wp-content/uploads/2017/02/\(V2-INTERNET\)%205-04.%20Article%20NEMO%20n%C2%B05%20Amine%20Beyhom%20170219S.pdf](http://nemo-online.org/wp-content/uploads/2017/02/(V2-INTERNET)%205-04.%20Article%20NEMO%20n%C2%B05%20Amine%20Beyhom%20170219S.pdf)] p. 53–275.
 17. BEYHOM, Amine : “A Hypothesis for the Elaboration of Heptatonic Scales”, *Near Eastern Musicology Online* 4 6 [2017-11] [url: <http://nemo-online.org/wp-content/uploads/2017/05/INTERNET-6-01.-Article-NEMO-no.-4-6-1-Amine-Beyhom-Hypothesis-170501.pdf>] p. 5–89.
 18. BEYHOM, Amine : “MAT for the VIAMAP. Maqām Analysis Tools for the Video-Animated Music Analysis Project”, *Near Eastern Musicology Online* 4 7 [2018-11] [url: <http://nemo-online.org/>] p. 145–258.
 19. BEYHOM, Amine and Hamdi MAKHLOUF : “Fretage du ‘ūd (luth arabe) dans la théorie musicale arabe et influence sur la pratique [The fretting of the ‘ūd in Arabian music theory and its interaction with practice]”, *5^{ème} Congrès de Musicologie Interdisciplinaire (CIM09), La musique et ses instruments, Fifth Conference on Interdisciplinary Musicology* | Paris, 2009-10-26] [url: <http://cim09.lam.jussieu.fr/CIM09-en/Proceedings.html>, http://cim09.lam.jussieu.fr/CIM09-en/Proceedings_files/Beyhom-Makhlouf.pdf].
 20. BOETHIUS : *Traité de la musique*, editor Christian Meyer, Brepols | Turnhout, 2004].
 21. BONTA, Stephen : “The Making of Gut Strings in 18th-Century Paris”, *The Galpin Society Journal* 52 [1999-4-1] [doi: 10.2307/842553. url: <http://www.jstor.org/stable/842553>] p. 376–386.
 22. BOUTERSE, Curtis : “Reconstructing the Medieval Arabic Lute: A Reconsideration of Farmer’s ‘Structure of the Arabic and Persian Lute’”, *The Galpin Society Journal* 32 [1979-5-1] [doi: 10.2307/841532. url: <http://www.jstor.org/stable/841532>] p. 2–9.
 23. BOWER, Calvin M. : *Bower 1989 Boethius’ Fundamentals Of Music*, editor Claude V. Palisca, *Music Theory Translation Series*, Yale University Press | New Haven & London, 1989] [url: <http://archive.org/details/bower-1989-fundamentals-of-music>].
 24. BUTLER, Alfred Joshua : *The Arab conquest of Egypt and the last thirty years of the Roman dominion*, Oxford, Clarendon Press [1902] [url: <http://archive.org/details/arabconquestegy00butlgoog>].
 25. CAREY, Travis : *Fret Tying with Travis Carey* [2017-4-19] [url: <https://www.youtube.com/watch?v=6T5MgtQSofI>].
 26. CHABRIER, Jean-Claude Ch. : “‘ūd”, editors Antoine Goléa and Marc Vignal, *Larousse de la musique (2) : Kreuzspiel - Zyklus*, Librairie Larousse | Paris, 1982] p. 1853.
 27. CHABRIER, Jean-Claude Ch., A. DIETRICH, Clifford Edmund BOWORTH and Henry George FARMER : “‘ūd: Encyclopaedia of Islam, Second Edition : Brill Online”, editors Peari Bearman, Th. Bianquis, C. E. Bosworth, et al., [*Print Version: Volume X, page 767, column 2*] [2000] [url: <http://www.brillonline.nl/>].
 28. CHAILLEY, Jacques : *Éléments de philologie musicale [Recherche des principes - Intervalles et Échelles]*, Alphonse Leduc | Paris, 1985].
 29. CHARRY, Eric : “Plucked Lutes in West Africa: An Historical Overview”, *The Galpin Society Journal* 49 [1996-3-1] [doi: 10.2307/842390. url: <http://www.jstor.org/stable/842390>] p. 3–37.

30. COLEBROOKE, Henry Thomas: *Algebra, with Arithmetic and Mensuration, from the Sanscrit of Brahmagupta and Bhascara*, John Murray [London, 1817].
31. COWL, Carl and Sheila M CRAIK: *Henry George Farmer: a bibliography*, Glasgow University Library Studies, GLUS [Scotland, 1999].
32. DALL'ORTO, Giovanni: “File:0372 - Pavia - S. Pietro - Cripta - Tomba Boezio - Foto Giovanni Dall'Orto, Oct 17 2009.jpg”, *Wikipedia* [Pavia - Italy, 2009-10-17] [url: https://en.wikipedia.org/wiki/File:0372_-_Pavia_-_S._Pietro_-_Cripta_-_Tomba_Boezio_-_Foto_Giovanni_Dall%27Orto,_Oct_17_2009.jpg].
33. DIEBUCHÉ: “Map of expansion of Caliphate” [2010-7-3] [Adapted from <http://guides.library.uit.edu/content.php?pid=27903&sid=322018> (via Image:Age_of_Caliphs.png), traced on high resolution version of Image:BlankMap-World6.svg. Information from *The Times Concise Atlas of World History* ed. by Geoffrey Bar-clough published by Times Books Ltd. Isbn 0-7230-0274-6 p. 40-41. url: https://commons.wikimedia.org/wiki/File:Map_of_expansion_of_Caliphate.svg].
34. DIETRICH, Friedrich Heinrich and İHWÂN AL-ŞAFĀ': *Die Propädeutik der Araber im zehnten Jahrhundert; die Logik und Psychologie der Araber im zehnten Jahrhundert n. Chr.: being a German translation of the Rasā'il Ikhwān aṣ-Ṣafā'. Ch. 1-13, منشورات معهد تراث الإسلام 22; 22; Mansūrat al-'ulūm العربية والإسلامية: فلسفة الإسلامية; 22; Mittler u. Sohn [Berlin, 1865].*
35. DURING, Jean: “Introduction au Volume 71 1/2 de la Revue de Musicologie(1985)”, *Revue de musicologie* 71 1/2 [1985] [doi: 10.2307/928593. url: <https://www.jstor.org/stable/928593?origin=crossref>] p. 7–10.
36. DURING, Jean: *Quelque chose se passe: le sens de la tradition dans l'Orient musical*, Verdier [Lagrasse, 1994].
37. EHWANY (EL-), Ahmed Fouad: “Al-Kindi”, *A history of Muslim philosophy: With short accounts of other disciplines and the modern renaissance in Muslim lands*, ed. Mian Mohammad Sharif, Harrassowitz [Allemagne, 1966] [url: <http://www.muslimphilosophy.com/hmp/>] p. 421–434.
38. ERLANGER, Rodolphe (d'): *La musique arabe, 6 tomes – I. [Al-Fārābī] (1930); II. [Al-Fārābī et Ibn Sīnā] (1935); III. [Commentaires sur Le Livre des Cycles de Saḡīyya-a-d-Dīn al-Urmawī] (1938); IV. [Anon. – a-sh-Shīrwānī – et al-Lādhīqī] (1939); V. [Échelles et modes] (1949); VI. [Rythmes et formes] (1959) 6 (vols.)*, Librairie orientaliste Paul Geuthner [Paris, 1930-1959].
39. ESPINOZA, Santiago: *Vihuela Frets/Trastes Part 1* [2015-3-25] [url: <https://www.youtube.com/watch?v=NYaXlKRfC2E>].
40. FĀRĀBĪ (AL-), Abū-n-Naṣr Muḥammad ibn Muḥammad ibn Tarkhān: *La musique arabe (1) – Al-Fārābī, Grand traité de la musique [Kitāb al-Mūsīqī al-Kabīr] (Livres I et II)*, editor Rodolphe d'Erlanger, translator Rodolphe (d') Erlanger 1/6 (vols.), Librairie Orientaliste Paul Geuthner [Paris, France, 1930].
41. FĀRĀBĪ (AL-), Abū-n-Naṣr Muḥammad ibn Muḥammad ibn Tarkhān: *الكتب الموسيقية الكبير*, editors Maḥmūd Aḥmad al-Ḥifnī and محمد أحمد الحفني *Turāthuna*, 1967 القاهرة. [دار الكتب العربي للطباعة والنشر]
42. FĀRĀBĪ (AL-), Abū-n-Naṣr Muḥammad ibn Muḥammad ibn Tarkhān: *الكتب الموسيقية الكبير*, *Manuscrit*, معهد تاريخ العلوم العربية والإسلامية في جمهورية ألمانيا الاتحادية, 1998 [إطرا جامعة فرانكفورت] [فرانكفورت].
43. FĀRĀBĪ (AL-), Abū-n-Naṣr Muḥammad ibn Muḥammad ibn Tarkhān and al-Ḥusayn ibn 'Abd-al-Lāh Sīnā (IBN) OU AVICENNE (980?-1037): *La musique arabe (2) – Al-Fārābī [Grand traité de la musique] Livre III du Kitāb al-Mūsīqī al-Kabīr; Sīnā (ibn) ou Avicenne*, Kitāb a-sh-Shifā' – *Mathématiques*, translator Rodolphe (d') Erlanger, 1st ed. 2/6 (vols.), Librairie Orientaliste Paul Geuthner [Paris, 1935].
44. FĀRĀBĪ (AL-), Abū-n-Naṣr Muḥammad ibn Muḥammad ibn Tarkhān and al-Ḥusayn ibn 'Abd-al-Lāh Sīnā (IBN) OU AVICENNE (980?-1037): *La musique arabe (2) – Al-Fārābī [Grand traité de la musique] Livre III du Kitāb al-Mūsīqī al-Kabīr; Sīnā (ibn) ou Avicenne*, Kitāb a-sh-Shifā' – *Mathématiques*, editor Christian Poché, translator Rodolphe (d') Erlanger, ed. 2^e en fac-similé, *Les Geuthner (Paris)*, ISSN 1294-6656 2/6 (vols.), Librairie Orientaliste Paul Geuthner [Paris, 2001].
45. FARMER, Henry George: *A History of Arabian Music to the XIIIth Century*, Luzac [Bristol, Great-Britain, 1929].
46. FARMER, Henry George: *Historical facts for the Arabian musical influence*, Ayer Publishing [1930].
47. FARMER, Henry George: “Was the Arabian and Persian Lute Fretted?”, *Journal of the Royal Asiatic Society of Great Britain and Ireland* 3 [1937-7-1] [url: <http://www.jstor.org/stable/25201549>] p. 453–460.
48. FARMER, Henry George: *Studies in oriental musical instruments. With four plates and other illustrations. Second series* [1939a].
49. FARMER, Henry George: “The Structure of the Arabian and Persian Lute in the Middle Ages”, *Journal of the Royal Asiatic Society of Great Britain and Ireland* 1 [1939b-1-1] [url: <http://www.jstor.org/stable/25201835>] p. 41–51.
50. FARMER, Henry George: *The sources of Arabian music: an annotated bibliography of Arabic manuscripts which deal with the theory, practice, and history of Arabian music from the eighth to the seventeenth century*, E. J. Brill [1965].
51. FARMER, Henry George: “Music”, *A history of Muslim philosophy: With short accounts of other disciplines and the modern renaissance in Muslim lands*, ed. Mian Mohammad Sharif, Harrassowitz [Allemagne, 1966a] [url: <http://www.muslimphilosophy.com/hmp/>] p. 1124–1177.
52. FARMER, Henry George: *Geschichte der arabisch-islamischen Musik*, VEB deutscher Verl. für Musik [1966b].
53. FARMER, Henry George: “GHīnā”, *Encyclopaedia of Islam, [Print Version: Volume II, page 1072, column 2]* [2011] [url: <http://www.brillonline.nl/>] p. 1072.
54. FARMER, Henry George, Werner BACHMANN, Heinrich BESSELER and Max SCHNEIDER: *Musikgeschichte in Bildern: Islam, [Band III: Musik des Mittelalters und der Renaissance / Lieferung 2]*, Veb Deutscher Verlag Fur Musik [Leipzig, 1966].
55. GIBB, H. A. R.: *The Arab Conquest in Central Asia, Reprint from the (1923) edition*, AMS Edition [New York -EU, 1970].
56. GILMAN, Benjamin Ives: “On Some Psychological Aspects of the Chinese Musical System”, *The Philosophical Review* 1 1 [1892-1-1] [doi: 10.2307/2175529. url: <http://www.jstor.org/stable/2175529>] p. 54–78.
57. GRAME, Theodore: “The Symbolism of the ‘ūd”, *Asian Music, Asian Music* 3 1 [1972-1-1] [doi: 10.2307/834102. url: <http://www.jstor.org/stable/834102>] p. 25–34.
58. GRUNEBaum, Gustave E. von: “The Concept of Plagiarism in Arabic Theory”, *Journal of Near Eastern Studies* 3 4 [1944-10] p. 234–253.
59. GUETTAT, Mahmoud: *Musiques du monde arabo-musulman: Guide bibliographique et discographique: Approche analytique et critique, Chants et poésies du Maghreb*, Dar al-Urs [El Ouns] [Paris, France, 2004].
60. HASSAAN, G. A.: “Banu Musa, the founders of automatic control in the 9th century”, *Proceedings of the MDP-8, Cairo University Conference on Mechanical Design and Production, Cairo, Egypt* [2004] [url: http://scholar.cu.edu.eg/sites/default/files/galal/files/banu-musa_control.pdf] p. 1–6.
61. HASSAN, Scheherazade Qassim: “The Long Necked Lute in Iraq”, *Asian Music* 13 2 [1982-1-1] [doi: 10.2307/833875. url: <http://www.jstor.org/stable/833875>] p. 1–18.

62. HELLOWIG, Friedemann: “An Example of Lute Restoration”, *The Galpin Society Journal* 23 [1970] [doi: 10.2307/842064]. url: <http://www.jstor.org/stable/842064>] p. 64–68.
63. HELLOWIG, Friedemann: “Lute Construction in the Renaissance and the Baroque”, *The Galpin Society Journal* 27 [1974-5-1] [doi: 10.2307/841751]. url: <http://www.jstor.org/stable/841751>] p. 21–30.
64. HILARIAN, Larry Francis: “The Structure and Development of the Gambus (Malay-Lutes)”, *The Galpin Society Journal* 58 [2005-5-1] [url: <http://www.jstor.org/stable/25163827>] p. 66–216.
65. IKHWĀN A-Ş-ŞAFĀ’: *Rasā’il Ikhwān a-Ş-Şafā’, Turāth al-‘Arab* 1/4 (vols.), Dār Bayrūt li-ṭ-Ṭibā’a wa-n-Naṣr [Beirut - Lebanon, 1983].
66. IVRY, Alfred L.: “al-Kindī and the Mu’tazila: A Philosophical and Political Reevaluation”, *Oriens* 25/26 [1976-1-1] [doi: 10.2307/1580657]. url: <http://www.jstor.org/stable/1580657>] p. 69–85.
67. JARGY, Simon and Alexis CHOTIN: “La Musique Arabe”, editor Roland-Manuel, *Histoire de la musique Tome I - Des Origines à Jean-Sébastien Bach, Encyclopédie de la Pléiade* 1/2 (vols.), Gallimard [Paris, 2001] p. 526–571.
68. KĀTĪB (AL-), Al-Ḥasan ibn Aḥmad ibn ‘Alī: *La Perfection des connaissances musicales: un traité de musique arabe du XI^e siècle [Kitāb Kamāl Adab al-Ghinā’]*, translator Amnon Shiloah, *Bibliothèque d’études islamiques, ISSN 0151-1750; 5*, Librairie Orientaliste Paul Geuthner [Paris, 1972].
69. KĀTĪB (AL-), Al-Ḥasan ibn Aḥmad ibn ‘Alī: *كتاب كمال أدب الغناء [Kitāb Kamāl Adab al-Ghinā’]*, editors Ghaffās ‘Abd-al-Malik Khashaba, Mahmūd Aḥmad Hifnī (al-), and الهيئة المصرية محمود أحمد الحفني, الهيئة المصرية *Al-Hay’a al-Miṣriyya al-‘amma li-l-Kitāb* [1975].
70. KHALIDI, Tarif and Abi-l-Ḥasan ‘Alī ibn al-Ḥusayn ibn ‘Alī al-Maṣ’ūdī: “Mas’ūdī’s Lost Works: A Reconstruction of Their Content”, *Journal of the American Oriental Society* 94 1 [1974-1-1] [doi: 10.2307/599728]. url: <http://www.jstor.org/stable/599728>] p. 35–41.
71. KHAWĀRIZMĪ (AL-), Abū ‘Abd-al-Lāh Muḥammad ibn Aḥmad ibn Yūsuf al-Kātib: *Liber Mafātīh al-‘Ulūm [Mafātīh al-‘ulūm]*, editor G. Vloten (van), E. J. Brill [Leiden?], 1895].
72. KHAWĀRIZMĪ (AL-), Abū ‘Abd-al-Lāh Muḥammad ibn Aḥmad ibn Yūsuf al-Kātib: *Mafātīh al-‘Ulūm*, editor Jawdat Fakhr-a-d-Dīn, Dār al-Manāhil [Beyrouth, 1991].
73. KHULĀ’Ī (AL-), Muḥammad Kāmil: *كتاب الموسيقى الشرقي [The book of oriental music / Le livre de la musique orientale]* [1904].
74. KIESEWETTER, Raphael Georg: *Über die Musik der neueren Griechen*, Breitkopf und Härtel [1858].
75. KINDĪ (AL-), Ya’qūb ibn Ishāq Abū Yūsuf (0801?-0867?): *مؤلفات مؤلفات Mu’allaḥāt al-Kindī al-Mūsīqīyya: 1. Risāla fi Khubr Šinā’at at-Ta’līf [British Museum, MS. Or, 2361, f^s 165^r-168^r, possibly 160^r-163^r]; 2. Kitāb al-Muṣawwītāt al-Watariyya min dhāt al-Watar al-Wāhid ilā dhāt al-‘Asharat Awtār [Bodleian Library (Oxford), MS. Marsh, 663, p. 246-265]; 3. Risāla fi Ajzā’ Khubariyya fi-l-Mūsīqā [Berlin, MS. Ahlwardt, 5503, f^s 31^v-35^v]; (4. Mukhtaṣar al-Mūsīqā fi Ta’līf a-n-Nagham wa Šin’at al-‘ūd [Berlin, MS. Ahlwardt, 5531, f^s 22^r-24^v, supposedly from Euclidos]); 5. A-r-Risāla al-Kubrā [aw al-Kitāb al-A’zam] fi-t-Ta’līf [Berlin, MS. Ahlwardt, 5530, f^s 25^r-31^r, in fact the Risāla fi-l-Luḥūn wa-n-Nagham], 9th century, editors Zakariyyā Yūsuf and زكريا يوسف Maṭba’at Shafīq (المجمع العلمي العراقي) [Baghdād, 1962a].*
76. KINDĪ (AL-), Ya’qūb ibn Ishāq Abū Yūsuf (0801?-0867?): “Kitāb al-Muṣawwītāt al-Watariyya min dhāt al-Watar al-Wāhid ilā dhāt al-‘Asharat Awtār [Bodleian Library (Oxford), MS. Marsh, 663, p. 246-265]”, *Mu’allaḥāt al-Kindī al-Mūsīqīyya* [Kindī’s writings on music], ed. Zakariyyā Yūsuf, Vol. 2, Maṭba’at Shafīq [Baghdād, 1962b].
77. KINDĪ (AL-), Ya’qūb ibn Ishāq Abū Yūsuf (0801?-0867?): *Risāla fi-l-Luḥūn wa-n-Nagham (Mukhtaṣar al-Mūsīqā fi Ta’līf a-n-Nagham wa Šin’at al-‘ūd) [from Manisa (Turquie), MS. 1705, f^s 110^v-123^r]* رسالة الكندي في اللحن والنغم Maṭba’at Shafīq [Baghdād, 1965].
78. KINDĪ (AL-), Ya’qūb ibn Ishāq Abū Yūsuf (0801?-0867?) and Yūsuf SHAWQĪ: *Risālat al-Kindī fi Khubr šinā’at al-ta’līf*, Dār al-Kutub al-Miṣriyya [Al-Qāhira, 1996].
79. LĀDHIQĪ (AL-), Muḥammad ibn ‘Abd-al-Ḥamid: *الحاج هشام محمد الراجب محمد بن عبد الحميد اللاتقي الرسالة القحبة (في الموسيقى)* and Ḥāshim Muḥammad Rajab (a-r-) [Kuwait, 1986a].
80. LĀDHIQĪ (AL-), Muḥammad ibn ‘Abd-al-Ḥamid: *A-r-Risāla al-Fathiyya (fi-l-Mūsīqā), A-s-Silsila a-t-Turāthiyya* 16, *Al-Majlis al-‘Arabīyy li-t-Turāth wa-l-Funūn wa-l-Ādāb* [Kuwait, 1986b].
81. LEONI, Stefano A. E.: “Kanz al-Tuhaf (Al-Musiḳi). The Casket of (Music) Rarities: Ars Musica and Musica Practica between Islam and Christianity”, *International Review of the Aesthetics and Sociology of Music* 27 2 [1996-12-1] [doi: 10.2307/3108345]. url: <http://www.jstor.org/stable/3108345>] p. 167–183.
82. LIU, Donsheng, 劉東升, Quanyou YUAN and 袁荃荃: *Zhongguo yinyue shi tujian [An illustrated guide for Chinese Music history]*, Renmin yinyue [Beijing, 1988].
83. MAALOUF, Shireen: *History of Arabic Music Theory, change and continuity in the Tone Systems, Genres, and Scaled.*, Université Saint-Espirit de Kaslik [Kaslik - Lebanon, 2002].
84. MAKHLouF, Hamdi: *Orientalism in Musicology - frets-Kindī for CIM 09 Hamdi Makhlof*, .MOV, .MP4, Documentary [2009a] [url: <http://www.hamdi-makhlof.com/library/biblio/makhlof/cim09/video-1-kindi.mp4>, <http://cermaa.foredefico.org/wp-content/uploads/2017/10/Orientalism%20in%20Musicology%20-%20frets-kindī%20for%20CIM%2009%20Hamdi%20Makhlof.mp4>].
85. MAKHLouF, Hamdi: *Orientalism in Musicology - frets-Tahhān for CIM 09 Hamdi Makhlof*, .MOV, .MP4, Documentary [2009b] [url: <http://www.hamdi-makhlof.com/library/biblio/makhlof/cim09/video-2-tahhan.mp4>, <http://cermaa.foredefico.org/wp-content/uploads/2017/10/Orientalism%20in%20Musicology%20-%20frets-Tahhan%20for%20CIM%2009%20Hamdi%20Makhlof.mp4>].
86. MAKHLouF, Hamdi: *Fretting of the ‘ūd according to (al-) Kindī*, mp4 [Paris (France), 2009c/2020] [url: https://www.youtube.com/watch?v=d7TTInH_pKM&feature=youtu.be].
87. MAKHLouF, Hamdi: *Fretting of the ‘ūd according to Ibn a-t-Tahhān*, mp4 [Paris (France), 2009d/2020] [url: <https://www.youtube.com/watch?v=demT-hpcX1s&feature=youtu.be>].
88. MANIK, Liberty: *Das arabische Tonsystem im Mittelalter, Tuta Sub Aegide Pallas*, E.J. Brill [Leiden, 1969].
89. MAS’ŪDĪ, Abi-l-Ḥasan ‘Alī ibn al-Ḥusayn ibn ‘Alī al-: *Murūj A-dh-Dhahab wa Ma’ādin al-Jawhar, 10th century 4* (vols.), Al-Maktaba al-‘Asriyya [Sidon - Beirut, 1987].
90. MATHIESEN, Thomas J.: *Apollo’s lyre: Greek music and music theory in antiquity and the Middle Ages*, University of Nebraska Press [Nebraska - EU, 1999].
91. MEYNARD, M. C. Barrier de: “Ibrahim, fils de Mehdi, Fragments historiques. Scènes de la vie d’artistes au III^e siècle de l’Hégire (778-839 de notre ère)”, *Journal Asiatique ou recueil de mémoires d’extraits et de notices relatifs à l’histoire, à la philosophie, aux langues et à la littérature des peuples orientaux* 6 XIII [1869-1] p. 201–342.

92. MUNAJJIM (AL-), Yahyā ibn ‘Alī ibn Yahyā: *Risālat ibn al-Munajjim fi-l-Mūsīqā wa Kashf Rumūz Kitāb al-Aghānī*, editor Yūsuf Shawqī, Dār al-Kutub [Cairo, Egypt, 1976].
93. NADĪM (IBN A-N-), Muḥammad ibn Ishāq al-Warrāq: *Kitāb al-Fihrist*, Librairie Khayyāt (rue Bliss) [Beirut, s.d.].
94. NEUBAUER, Eckhard: “Der Bau der Laute und ihre Besaitung nach arabischen, persischen und türkischen Quellen des 9. bis 15. Jahrhunderts”, *Zeitschrift für Geschichte der Arabisch- Islamischen Wissenschaften*, Institut für Geschichte der Arabisch-Islamischen Wissenschaften an der Johann Wolfgang Goethe-Universität [Frankfurt am Main, 1993] p. 279–378.
95. NEUBAUER, Eckhard: “Ibn al-Nadīm”, *Grove Music Online* [2001a].
96. NEUBAUER, Eckhard: “Mawṣilī, al- (2) Ishāq al-Mawṣilī”, *Grove Music Online* [2001b] [].
97. NEUBAUER, Eckhard: “Iṣfahānī, al-”, *Grove Music Online* [2001c].
98. PAOLIUTAOPD: *Fasting gut frets* [2010-12-5] [url: <https://www.youtube.com/watch?v=6altqGZ0zJs>].
99. PARISOT, Jean (1862-): *Musique orientale: Conférence prononcée dans la salle de la Société Saint-Jean, le 28 février 1898*, Schola Cantorum [Paris, 1898].
100. PLATO: *The Republic Of Plato*, translator Benjamin Jowett [1908] [url: <http://archive.org/details/in.ernet.dli.2015.223393>].
101. POCHÉ, Christian: “‘ūd”, *Grove Music Online* [2001].
102. PRATT, Vaughan: “Algebra”, *Stanford Encyclopedia of Philosophy* [2007] [url: <http://plato.stanford.edu/entries/algebra/>].
103. QIFĪ (IBN AL-), Jamāl-a-d-Dīn Abū-l-Ḥasan Alī Ibn Yūsuf, August MÜLLER and Julius LIPPERT: *Tārīkh al-Ḥukamā*, Dieterich [1903] [url: <http://archive.org/details/TarikhAlHukama>].
104. RASHĪD, Ṣubḥī Anwar: *Tārīkh al-‘ūd*, Dār ‘Alā’u-d-Dīn [Damas - Syrie, 1999].
105. ROSEN, Frederic: *The Algebra of Mohammed Ben Musa*, The Oriental Translation Fund [London, 1831].
106. RŪḤĀNĀ, Sharbil شربل روحنا: *منهج العود*, CNSML (Conservatoire National Supérieur de Musique - Liban) [Beirut, 2001].
107. SACHS, Curt: *The History of Musical Instruments* [1940] [url: http://archive.org/details/the_history_of_musical_instruments_curt_sachs].
108. {ŞAFADĪ (A-Ş-)}, Khalīl ibn Aybak Şalāḥ-a-d-Dīn : خليل بن أيك الصفي : *Risāla fi ‘Ilm al-Mūsīqā*, editors ‘Abdul-Majīd Dyāb, Ghaṭṭās ‘Abd-al-Malik Khashaba, والأستاذ غطلس عبد الملك خشبة, and الدكتور Turāthuna, عبد المجيد دياب, *Turāthuna*, Al-Hay’a al-Miṣriyya al-‘Āmma li-l-Kitāb [Le Caire, 1991-1297?-1363] xiv^e siècle].
109. SALMA (A-N-NAḤAWĪ AL-LUGHAWĪ), Abū Ṭālib al-Mufaḍḍal (ibn): *Kitāb al-Malāḥi wa Asmā’ihā min Qibal al-Mūsīqā*, editor ‘Abd-al-Malik Khashaba Ghaṭṭās, 9th century, Al-Hay’a al-Miṣriyya al-‘Āmma li-l-Kitāb [Cairo, 1984].
110. SAWA, George D.: “The Survival of Some Aspects of Medieval Arabic Performance Practice”, *Ethnomusicology* 25 1 [1981-1-1] [doi: 10.2307/850975. url: <http://www.jstor.org/stable/850975>] p. 73–86.
111. SAWA, George D.: “Oral transmission in arabic music, past and present”, *Oral tradition* 1989 [2002] [url: http://www.journal.oraltradition.org/files/articles/4i-ii/4_1-2_complete.pdf#page=265] p. 254–65.
112. SAWA, George Dimitri: “The Status and Roles of the Secular Musicians in the Kitāb al-Aghānī (Book of Songs) of Abu al-Faraj al-Iṣbahānī (D. 356 A. H./967 A. D.)”, *Asian Music* 17 1 [1985-10-1] [doi: 10.2307/833741. url: <http://www.jstor.org/stable/833741>] p. 69–82.
113. SAWA, George Dimitri: *Music performance practice in the early ‘Abbāsīd era: 132-320 AH/750-932 AD*, Pontifical Institute of Mediaeval Studies. Studies and texts, ISSN 0082-5328 ; 92, Pontifical Institute of Mediaeval Studies [Belgique, 1989].
114. SAWA, George Dimitri: “The Kitāb al-Aghānī”, Routledge [United Kingdom, 2001-8-1] [url: <http://gind.alexanderstreet.com/View/330237#page351>] p. 351–356.
115. ŞAYDĀWĪ (A-Ş-), شمس الدين الصيداوي النمشقي Shams-a-d-Dīn (a-d-Dī-mashqī): BNF Ms. or-2480 *Kitāb al-In‘ām fi Ma’rifat al-Anghām wa Sharḥihā* = *Kitāb fi Ma’rifat al-Anghām wa Sharḥihā* (كتب في معرفة الأنغام وشرحها) [15th century].
116. ŞAYDĀWĪ (A-Ş-), شمس الدين الصيداوي النمشقي Shams-a-d-Dīn (a-d-Dī-mashqī) and Thérèse (soeur Berthe) ANTAR: *Kitāb al-In‘ām fi Ma’rifat al-Anghām wa Sharḥihā* = *Kitāb fi Ma’rifat al-Anghām wa Sharḥihā* (كتب في معرفة الأنغام وشرحها) [traduction et commentaire par Thérèse B. Antar du manuscrit BNF Ms. or-2480] (*Exploitation de la couleur en musique: Livre de la connaissance des tons et leur explication*), Chemaly and Chemaly [Beyrouth, 2001-15th century].
117. SHEPHERD, Martin: *Luteshop’s Top Tips - Tying Frets* [2016-10-23] [url: https://www.youtube.com/watch?v=Qs_pXOoBVLU].
118. SHILOAH, Amnon: *RISM: the theory of music in Arabic writings (c. 900-1900): descriptive catalogue of manuscripts in Libraries of Europe and the U.S.A.*, Henle [1979].
119. SHILOAH, Amnon: “The Arabic Concept of Mode”, *Journal of the American Musicological Society* 34 1 [1981-4-1] [doi: 10.2307/831033. url: <http://jams.ucpress.edu/cgi/doi/10.2307/831033>] p. 19–42.
120. SHILOAH, Amnon: *La musique dans le monde de l’islam: une étude socio-culturelle*, translator Christian Poché, *Les Chemins de la musique (Paris. 1992), ISSN 1242-5540* [2002].
121. SHIRWĀNĪ (AL-), Faṭḥ-al-Lāh: *Majalla fi-l-Mūsīqā* [مجلة في الموسيقى MS. 3449, *Topkapi (Istanbul), 95th*], editor Eckhard Neubauer, Institut für Geschichte der Arabisch-Islamischen Wissenschaften [Frankfurt am Main, 1986].
122. SHIRWĀNĪ (AL-), Faṭḥ-al-Lāh and Muḥammad ibn ‘Abd-al-Ḥamid LĀDHĪQĪ (AL-): *La musique arabe (4) – I. Traité anonyme [attribué à Shirwānī (a-sh) – Majalla fi-l-Mūsīqā* [مجلة في الموسيقى] *dédié au Sultan Osmānli Muḥammad II (XV^e siècle). II. Al-Lādhīqī, Traité al-Faṭḥiyya (XV^e siècle)*, translator Rodolphe (d’) Erlanger 4/6 (vols.), Librairie Orientaliste Paul Geuthner [Paris, 1939].
123. SHIRWĀNĪ (AL-), Faṭḥ-al-Lāh and Muḥammad ibn ‘Abd-al-Ḥamid LĀDHĪQĪ (AL-): *La musique arabe (4) – I. Traité anonyme [attribué à Shirwānī (a-sh) – مجلة في الموسيقى] dédié au Sultan Osmānli Muḥammad II (XV^e siècle). II. Al-Lādhīqī, Traité Al-Faṭḥiyya (XV^e siècle)*, editor Christian Poché, translator Rodolphe (d’) Erlanger, ed. 2^e en facsimilé, *Les Geuthner (Paris), ISSN 1294-6656 4/6* (vols.), Librairie Orientaliste Paul Geuthner [Paris, 2001].
124. SIDDIQĪ, M. R.: “Mathematics and Astronomy”, *A history of Muslim philosophy: With short accounts of other disciplines and the modern renaissance in Muslim lands*, ed. Mian Mohammad Sharif, Harrasowitz [Allemagne, 1966] [url: <http://www.muslimphilosophy.com/hmp/>] p. 1277–1292.
125. SINĀ (IBN) OR AVICENNA (980?-1037): “Kitāb a-sh-Shifā’ - Riyādiyyāt 3 - Jawāmī ‘Ilm al-Mūsīqā”, Wizārat a-t-Tarbiya wa-t-Ta’līm, Al-Maṭba‘a al-Amīriyya [Cairo, 1956].
126. SOLIE, Ruth A.: “Melody and the Historiography of Music”, *Journal of the History of Ideas* 43 2 [1982-4-1] [doi: 10.2307/2709205. url: <http://www.jstor.org/stable/2709205>] p. 297–308.
127. SPENCER, Robert: “How to Hold a Lute: Historical Evidence from Paintings”, *Early Music* 3 4 [1975-10-1] [url: <http://www.jstor.org/stable/3125403>] p. 353–354.
128. STERLING, Bruce and Greg BEAR: *Mozart en verres miroirs*, Denoël [Paris, 1996].

129. STEWART, Devin : “The Structure of the Fihrist: Ibn al-Nadim as historian of Islamic legal and Theological Schools”, *International Journal of Middle East Studies* 39 3 |2007| p. 369–387.
130. SUBRAMANIAN, Karaikudi S. : “An Introduction to the Vina”, *Asian Music* 16 2 |1985-4-1| [doi: 10.2307/833772. url: <http://www.jstor.org/stable/833772>] p. 7–82.
131. ṬAḤḤĀN (IBN A-Ṭ-~ AL-MŪSĪQĪ), Abū-l-Ḥusayn Muḥammad ibn al-Ḥasan : *Ḥāwī al-Funūn wa-Salwat al-Maḥzān [transcription dactylographiée de Zakariyyā Yūsuf]*, editor Zakariyyā Yūsuf, Al-Majma‘ al-‘Arabiyy li-l-Mūsīqā |Baghdad, 1976|.
132. ṬAḤḤĀN (IBN A-Ṭ-~ AL-MŪSĪQĪ), Abū-l-Ḥusayn Muḥammad ibn al-Ḥasan : *Compendium of a Fatimid court musician – Ḥāwī al-Funūn wa-Salwat al-Maḥzān [Reproduction du manuscrit Funūn Jamīla 539 de la Bibliothèque nationale, Dār al-Kutub, du Caire]*, editor Eckhard Neubauer, *Facsimile Editions*; 52, Institut für Geschichte der Arabisch-Islamischen Wissenschaften |Frankfurt am Main, 1990|.
133. THE BIRYANI BOYS: *Amazing Sitar Player* [New-York?, 2008] [url: <https://www.youtube.com/watch?v=hTPxqUtlLdo>].
134. TIFĀSHĪ, Aḥmad ibn Yūsuf : *Mu‘at al-asmā‘ fi ‘ilm al-samā‘*, editor Rachid Sellami, ed. al-Ṭab‘ah al-ūlā, al-Majma‘ al-Tūnisī lil-‘Ulūm wa-al-Adāb wa-al-Funūn |Tūnis, 2019|.
135. TSUGE, Gen’ichi : “Musical Instruments Described in a Fourteenth-Century Persian Treatise” |2013| p. 25.
136. URMAWĪ (D. 1294), Ṣafīyy-a-d-Dīn ‘Abd-al-Mu‘min ibn Yūsuf ibn (ab-i-l-Ma)Fākhir (al-) I : *كتاب النين الارموي: صفي النين الارموي* *Kitāb al-Adwār fi-l-Mūsīqā [Livre des cycles musicaux – MS. Istanbul, Nuruosmaniye 3653, f^o 1a-49a (1r^o-49^o), possiblement autographe]* 2. *A-ṭ-Risāla a-sh-Sharafīyya fi-n-Nisab a-t-Ta‘līfīyya [L’Épître à Sharaf-a-d-Dīn sur les proportions musicales – MS. Ahmet III 3460, f^o 1a-68a (1r^o-68^o), copie datant de 827H/1424C]*, editor Eckhard Neubauer, (معهد تزيخ العلوم العربية والإسلامية) Institut für Geschichte der Arabisch-Islamischen Wissenschaften |Frankfurt am Main, 1984|.
137. URMAWĪ (D. 1294), Ṣafīyy-a-d-Dīn ‘Abd-al-Mu‘min ibn Yūsuf ibn (ab-i-l-Ma)Fākhir (al-) *كتاب الأنوار في الموسيقى: صفي النين الارموي* [*Kitāb al-Adwār (fi-l-Mūsīqā)*], editors Maḥmūd Aḥmad Ḥifnī (al-), Ghaṭṭās ‘Abd-al-Malik Khashaba, محمود أحمد الخطي، الجينة، and عطلس عبد الملك خشبة, and المصرية العلية للكتاب Al-Hay‘a al-Miṣriyya al-‘Āmma li-l-Kitāb |Le Caire, 1986|.
138. URMAWĪ (D. 1294), Ṣafīyy-a-d-Dīn ‘Abd-al-Mu‘min ibn Yūsuf ibn (ab-i-l-Ma)Fākhir (al-) *صفي النين الارموي* : “Kitāb al-Adwār – ljs235”, [D. 1293, XIII^e siècle] |2001| [formerly available at url: <http://sceti.library.upenn.edu/ljscollection/index.cfm>, <http://dewey.library.upenn.edu/sceti/ljs/PageLevel/index.cfm?ManID=ljs235>].
139. URMAWĪ (D. 1294), Ṣafīyy-a-d-Dīn ‘Abd-al-Mu‘min ibn Yūsuf ibn (ab-i-l-Ma)Fākhir (al-) *صفي النين الارموي* and ‘Alī ibn Muḥammad [JURJĀNĪ (AL-)] : *La musique arabe (3) – I. A-sh-Sharafīyya ou Épître à Sharaf a-d-Dīn. II. (Commentaire anonyme du) Kitāb al-Adwār ou Livre des Cycles musicaux*, translator Rodolphe (d’) Erlanger, ed. orig., *La Musique Arabe* 3/6 (vols.), Librairie Orientaliste Paul Geuthner |Paris, 1938|.
140. URMAWĪ (D. 1294), Ṣafīyy-a-d-Dīn ‘Abd-al-Mu‘min ibn Yūsuf ibn (ab-i-l-Ma)Fākhir (al-) *صفي النين الارموي* and ‘Alī ibn Muḥammad [JURJĀNĪ (AL-)] : *La musique arabe (3) – I. A-sh-Sharafīyya ou Épître à Sharaf a-d-Dīn. II. (Commentaire anonyme du) Kitāb al-Adwār ou Livre des Cycles musicaux*, editor Christian Poché, translator Rodolphe (d’) Erlanger, ed. 2^e en fac-similé, *La Musique Arabe* 3/6 (vols.), Librairie Orientaliste Paul Geuthner |Paris, 2001|.
141. UṢĀYBĪ‘A (known as IBN ABĪ ~), Muwaffaq a-d-Dīn abī-l-‘Abbs Aḥmad ibn al-Qsim ibn Khalifa ibn Yūnis a-s-Sa‘dī al-Khazarjī: *‘Uyūn al-Anbā‘ fi Ṭabaqāt al-Atibbā‘, 12th century*, Al-Maktaba al-Wahbiyya |s.l., 1882|.
142. WACHSMANN, Klaus, James W. MCKINNON, Robert ANDERSON, et al. : “Lute”, *Grove Music Online* |2007-2012|.
143. WALZER, Richard : “New Studies on Al-Kindī”, *Oriens* 10 2 |1957-12-31| [doi: 10.2307/1579634. url: <http://www.jstor.org/stable/1579634>] p. 203–232.
144. WIKIPEDIA CONTRIBUTORS : “Muhammad ibn Musa al-Khwarizmi”, *Wikipedia* |2017a-9-26| [url: https://en.wikipedia.org/w/index.php?title=Muhammad_ibn_Musa_al-Khwarizmi&oldid=802487345].
145. WIKIPEDIA CONTRIBUTORS : “Early Muslim conquests”, *Wikipedia* |2017b-10-1| [url: https://en.wikipedia.org/w/index.php?title=Early_Muslim_conquests&oldid=803209553].
146. WIKIPEDIA CONTRIBUTORS : “Abu al-Faraj al-Isfahani”, *Wikipedia* |2017c-10-5| [url: https://en.wikipedia.org/w/index.php?title=Abu_al-Faraj_al-Isfahani&oldid=803974536].
147. WIKIPEDIA CONTRIBUTORS : “Boethius”, *Wikipedia* |2020-9-20| [url: <https://en.wikipedia.org/w/index.php?title=Boethius&oldid=979470413>].
148. WRIGHT, Owen : “Ibn al-Munajjim and the Early Arabian Modes”, *The Galpin Society Journal* 19 |1966-4-1| [doi: 10.2307/841911. url: <http://www.jstor.org/stable/841911>] p. 27–48.
149. WRIGHT, Owen : *The modal system of Arab and Persian music, 1250-1300: an interpretation of contemporary texts.* |1969|.
150. WRIGHT, Owen : “Music at the Fatimid court: the evidence of the Ibn al-Ṭaḥḥān manuscript”, *L’Égypte fatimide: son art et son histoire (Actes du Colloque organisé à Paris les 28, 29 et 30 mai 1998)*, ed. M. Barucand, Presses de l’Université de Paris-Sorbonne |Paris, 1999| p. 537–545.
151. WRIGHT, Owen : “Fārābī, al-”, *Grove Music Online* |2001a|.
152. WRIGHT, Owen : “Ibn Sīnā”, *Grove Music Online* |2001b|.
153. WRIGHT, Owen : “Kindī, al-”, *Grove Music Online* |2001c|.
154. WRIGHT, Owen : “Ibn Zayla”, *Grove Music Online* |2001d|.
155. WRIGHT, Owen : “Shirwānī, al-”, *Grove Music Online* |2001e|.
156. WRIGHT, Owen : “Lādhiqī, al-”, *Grove Music Online* |2001f|.
157. WRIGHT, Owen : “Ibn al-Ṭaḥḥān”, *Grove Music Online* |2001g|.
158. WRIGHT, Owen : “Ikhwān al-Ṣafā’”, *Grove Music Online* |2001h|.
159. WRIGHT, Owen : “Munajjim, al-”, *Grove Music Online* |2001i|.
160. WRIGHT, Owen : “Al-Kindī’s Braid”, *Bulletin of the School of Oriental and African Studies* 69 01 |2006| p. 1–32.
161. WRIGHT, Owen, Christian POCHE and Amnon SHILOAH : “Arab music”, *New Grove Dictionary of Music and Musicians* 1/29 (vols.), Oxford University Press |2001| p. 797–833.
162. ZAKIR HUSSAIN and BRJ NARAYAN : *Raga Lalit / Raga Bairagi Bhairav - Brij Narayan, Sarod / Zakir Hussain, Tabla*, CD, Nimbus Records |1990|.
163. ZAPICO, Pablo : *Cómo poner un traste de tripa / How to put a gut fret* |2015-3-25| [url: <https://www.youtube.com/watch?v=IDVvXFewiTE>].
164. ZAYLA (IBN), al-Ḥusayn ibn Muḥammad : *الكافي في الموسيقى*, editor Zakariyyā Yūsuf, دار القلم (Dār al-Qalam) |1964|.