



HAL
open science

New U-series dates at the Caune de l'Arago, France

Christophe Falguères, Yuji Yokoyama, Guanjun Shen, James L Bischoff,
Teh-Lung Ku, Henry de Lumley

► **To cite this version:**

Christophe Falguères, Yuji Yokoyama, Guanjun Shen, James L Bischoff, Teh-Lung Ku, et al.. New U-series dates at the Caune de l'Arago, France. *Journal of Archaeological Science*, 2004, 31 (7), pp.941 - 952. 10.1016/j.jas.2003.12.008 . hal-03739356

HAL Id: hal-03739356

<https://cnrs.hal.science/hal-03739356>

Submitted on 13 Oct 2022

HAL is a multi-disciplinary open access archive for the deposit and dissemination of scientific research documents, whether they are published or not. The documents may come from teaching and research institutions in France or abroad, or from public or private research centers.

L'archive ouverte pluridisciplinaire **HAL**, est destinée au dépôt et à la diffusion de documents scientifiques de niveau recherche, publiés ou non, émanant des établissements d'enseignement et de recherche français ou étrangers, des laboratoires publics ou privés.

New U-series dates at the Caune de l'Arago, France.

Christophe Falguères^a, Yuji Yokoyama^a, Guanjun Shen^b, James L. Bischoff^c, Teh-Lung Ku^d & Henry de Lumley^a

^a Département de Préhistoire du Muséum National d'Histoire Naturelle, FRE2677 du CNRS, Institut de Paléontologie Humaine, 1, rue René Panhard, 75013, Paris, France. falguere@mnhn.fr, iph@mnhn.fr

^b Institute for Coastal and Quaternary Studies, Nanjing Normal University, 210097, Nanjing, Jiangsu, China. gjshen@pine.njnu.edu.cn

^c US Geological Survey, ms/470, 345 Middlefield Rd, Menlo Park, CA 94025, United States of America. jbischoff@usgs.gov

^d Department of Earth Sciences, 3651 Trousdale Parkway, University of Southern California, Los Angeles, CA 90089-0740, United States of America. rku@usc.edu

Abstract

In the beginning of the nineteen eighties, the Caune de l'Arago was the focus of an interdisciplinary effort to establish the chronology of the *Homo Heidelbergensis* (Preneandertals) fossils using a variety of techniques on bones and on speleothems. The result was a very large spread of dates particularly on bone samples. Amid the large spread of results, some radiometric data on speleothems showed a convergence in agreement with inferences from faunal studies.

We present new U-series results on the stalagmitic formation located at the bottom of Unit IV (at the base of the Upper Stratigraphic Complex). Samples and splits were collaboratively analyzed in the four different laboratories with excellent interlaboratory agreement. Results show the complex sequence of this stalagmitic formation. The most ancient part is systematically at internal isotopic equilibrium (>350 ka) suggesting growth during or before isotopic stage 9, representing a minimum age for the human remains found in Unit III of the Middle Stratigraphical Complex which is stratigraphically under the basis of the studied stalagmitic formation. Overlaying parts of the speleothem date to the beginning of marine isotope stages 7 and 5.

Key-words: Uranium-series dating, calcite, Middle Pleistocene, Caune de l'Arago.

Introduction

The Caune (cave) de l'Arago (Eastern Pyrenees, France) is significant to Paleoanthropology because of the discovery of Middle Pleistocene human remains. At the time, it was suggested that the Arago human bones belonged to the most ancient European lineage, probably correlating with the Mauer mandibule (Germany). Recent discoveries have established that Europe was already earlier inhabited by the end of the Lower Pleistocene, for instance in Spain at Atapuerca [7], in Italy at Ceprano [3] and, most recently, very earliest Pleistocene in Georgia at Dmanisi [17]. The Caune de l'Arago assemblage nevertheless remains a key site for the understanding of human evolution during the Middle Pleistocene. Establishing the chronology, therefore is of fundamental importance. The sedimentary fill was assigned to Middle Pleistocene on the basis of mammalian fauna [12, 19, 11].

A series of eight cores were drilled through the entire cave-filling in order to determine thickness and stratigraphy of the Quaternary deposits [28].

The lower stalagmitic floor (Fig.1) lay directly on the Urgonian bedrock. ESR analyses performed on three calcite samples (YC62, 9UL8, YCP17) yielded ages of 630 ± 100 ka, 760 ± 80 ka and 690 ± 70 ka respectively [53].

Directly overlaying this formation, the Lower Stratigraphical Complex (LSC) thickens to more than 7 m towards the rear of the cave, composed of two dark-clay sequences. The lower part of LSC is mainly homogeneous clay.

The Middle Stratigraphical Complex (MSC) is divided into a lower and an upper part. The lower part is composed of homogeneous stratified sands (Unit I). This unit is overlain by sandy-clayey silt (Unit II). The upper sequence, in turn, is stratified coarse sands (Unit III) and is homogeneous over its entire thickness of up to 4 m in the central part of the cave. The Unit III includes archaeological layers (G, F, E, D soils) that are separated from each other by sterile levels.

The Upper Stratigraphical Complex (USC) starts with Unit IV characterized by stalagmitic floors interstratified with silty-clayey sands. The speleothems are well-crystallized adjacent to the northern wall, less so toward the southern wall, and impure

and poorly crystallized in the central part of the cave. A trench cut in the northern part of the cave is shown in cross-section in Figure 2 where all the samples were taken for U-series analyses in the present study. Careful micro-stratigraphic study has shown that this formation is composed of “a series of laminated stalagmitic floors interstratified with clastic deposits mainly composed of loamy-clayey sands” [28]. This complex is capped by an angular breccia (Unit V) of coarse slightly-weathered gravels. The heavy mineral assemblage of the breccia is similar to that of the lower sequence of LSC and to that of MSC [31].

Preliminary ESR dating on the middle stalagmitic floor belonging to Unit IV, gave ages ranging between 415 to 490 ka [52].

The upper stalagmitic floor was thought to overlap Unit V but previous studies by Shen [41, 42] have shown that it has an age equivalent to the age of the middle stalagmitic floor (Unit IV) between 120 ka and older than 350 ka.

In the center of the cave, a washout-pocket caused extreme chemical/mineralogical alteration of Units III and IV, rendering the interpretation of the stratigraphical succession difficult. There is no doubt, however, that dating of Unit IV gives a minimum age to human remains found in the MSC and, particularly, in G soil.

To address the chronology an International Colloquium was organized in 1981 [29]. More than 250 samples were taken and distributed to about 20 international laboratories using a variety of methods including U-series [1, 8, 13, 26, 27, 40, 45, 49], Thermoluminescence [14, 34, 46], Electron Spin Resonance [2, 21, 23, 36, 51, 52], Fission Tracks [6, 49], and Amino Acid Racemization [4, 39, 43]. Samples included both bone and speleothem. The large spread of the results was perplexing and left uncertain the true age of the site.

Figure 3 exhibits the large scatter of the results yielded by U-series on calcite and bones sampled in various stratigraphic levels. The scatter is noteworthy for soil G in which many human remains (especially Arago XXI) were discovered, and where ages range between 500 and 30 ka for bone samples.

Since that time, much effort has been focused to try to understand the causes for the scatter and to improve the results. Several Ph.D. theses have been initiated and additional sampling campaigns have been organized [41, 42, 15].

We present in this paper a complete evaluation of the U-series results obtained on the stalagmitic floor (Unit IV) situated at the bottom of the Upper Stratigraphic Complex immediately overlying the hominid-bearing horizons.

Human remains

More than 100 human remains belonging to at least 26 individuals, have been discovered within MSC. About 60 teeth including 30% of lacteal, indicate that more than 50% are children. Two teeth were found in J soil (Unit I). The remains of 4 adults and one child were unearthed from G soil (Unit III). During the excavation of summer 2001, a mandible of a young woman (ARA89) was discovered in the G soil (to be published). The most important remains are Arago XXI skull [44, 30], Arago II mandible and Arago XLVII parietal [18], (Photo 1). F, E and D soils (Unit III) have yielded several remains belonging to 4 children, one adolescent and 3 adults. The youngest human remains (2 children and one adult) were extracted from C soil (Unit IV).

The human remains from Arago exhibit some derived features indicating Neandertals (posterior position of mental foramen and lack of canine fossa) and including them among Preneandertals [32].

The wide scatter of previous results presented in 1981 (see Fig. 3) precluded a definitive conclusion as to the chronology of the sediments. However, some ages were in general agreement with inferences from faunal association. Such is the case of the gamma-ray age of 450 ka obtained on the Arago XXI skull [50], that is coherent with the faunal associations that suggest a range between 500 and 350 ka for the MSC [12, 20]. The rhinoceros remains (*Dicerorhinus hemitoechus*) suggest an age between 600 and 400 ka [19]. At the bottom of the sequence, the fauna contains several carnivores (*canis lupus mosbachensis* and *Ursus deningeri*) associated with big ungulates (*Cervus elaphoides*, *Rangifer tarandus*, *Praevibos priscus*) that seem to correspond to a transition between Cromerian faunas and those that arrived at the beginning of the Upper Pleistocene [33]. Micromammal (rodent) studies suggested correlation of layers H to D of Arago to layer H of Orgnac III, primarily by the presence of *Microtus gregalis* [11]. The dating of a stalagmitic floor, stratigraphically under Orgnac layer H, assigns a maximum age of 300-350 ka to this level [16].

Methods and analyzed samples

The principles of the U/Th dating method [35] depends on the difference of solubility between uranium and thorium. Generally, well-crystallized speleothems often behave as closed systems with respect to uranium [24], taking up trace amounts of uranium as they form, but no Th. The amount of radiogenic ^{230}Th formed in ratio to its parent ^{234}U yields the age of formation of the speleothem.

About 50 samples were taken from the stalagmitic column (Fig. 2), in the north part of the cave, recently exposed by trenching and coring. The trench is oriented south-south-west/north-north-east. The speleothem extends some two meters laterally and reaches a thickness of 50 cm near the wall of the cave. Only 5 samples were taken on the eastern wall of the stalagmitic column, the other samples come from the western wall (Fig.4). The samples called PB have been analyzed at the U.S. Geological Survey laboratory of Menlo Park (United States of America). The PK samples have been measured at the University of Southern California of Los Angeles (United States of America). The others (YC, SH and CF) have been analyzed at the Centre des Faibles Radioactivités of Gif-sur-Yvette (France).

For analyses of the present study samples are first dissolved in nitric acid and artificial spikes of ^{232}U and ^{228}Th are added. Uranium and thorium isotopes are then isolated via ion-exchange resins and measured by alpha-ray spectrometry, following the method described by Bischoff et al. [10].

A few samples were analyzed by ESR in order to make comparisons between this method and U-series. ESR is based on the detection of accumulated natural radiation damage resulting from environmental radioactivities, and can be applied to carbonates, fossil teeth and quartz crystals [37, 22].

Results and Discussion

Table 1 shows uranium content, isotopic ratios and ages of all the samples. The uranium content is rather homogenous varying between 0.13 to 1.23 ppm, with only a few exhibiting higher values in the range between 1.49 and 3.30 ppm. $^{234}\text{U}/^{238}\text{U}$ ratios vary between 1.02 and 1.19. Samples are generally well crystallized and have low levels of detrital Th-contamination. $^{230}\text{Th}/^{232}\text{Th}$ ratios less than 15 indicate a sufficient

contamination to render the ages uncertain [9]. Among the 46 analyzed samples, only 9 show values ≤ 15 for this ratio. For the latter, ages have been corrected according to the scheme applied to impure carbonates proposed by Ku and Liang [25].

Calculated dates range between 104 and to >350 ka. At a first glance, the results seem difficult to interpret because of very different results given by samples which are very close from one to another (see for example PB5a and PB5b). Figure 4 shows a plan view of extent of various growth calcite units. Separable calcite units are designated as IV1 to IV5. The U-Th dates have been carefully examined according to these layers. Several age-groupings become apparent (Fig. 5). The first corresponds to the central part of the formation and gives systematically ages >300 ka. It includes layers IV1, IV2 and IV3. The second is confined to ages around 215 to 230 ka (layer IV4). The PK7 sample (at the left in J22, Fig. 2) provides an age of 140 ka and suggests that a thin layer would have grown during the marine isotopic stage 5 which could be in accordance with the fact that external layers are younger than central ones. However, the stratigraphical correlation between this layer and those observed in the southern stalagmitic column located on the other side of the cave, indicates an older age, marine isotopic stage 7 (Lumley, personal communication). The third group gives results ranging between 100 and 165 ka (layer IV5) excepting one sample (PK4) for which an age of 209 ka was obtained. The age-groupings are in general agreement with stratigraphic succession. We suggest the succession of stalagmite occurred as follows:

A thick basal stalagmite first grows on the cave floor. The top and lateral parts of this stalagmite is then eroded. Later layers then grow unconformably on the external sides of the previous stalagmite. All the U-Th ages support such a scheme, if we take into account the ages are given with one-sigma errors.

Figure 6 shows the different growth phases versus the isotope marine curve [5]. The central stalagmite that corresponds to stratigraphic layers IV1, IV2 and IV3, formed during isotopic stage 9 or older. The radiometric data attributed to layer IV4 indicate that this level formed at the beginning of marine isotope stage 7. Finally, the most recent part corresponding to layer IV5 formed during the last interglacial period (isotope stage 5).

Thus, we assign an age >350 ka to the human fossils of soil G of Unit III that lies stratigraphically beneath Unit IV stalagmitic formation. This assignment is consistent with the previous date of 455 ka obtained by gamma spectrometry directly on the Arago XXI skull [50]. These dates are also consistent with the ESR ages obtained on aeolian quartz taken between soils F and E of 430 ± 85 ka [48].

In addition, U-series data suggest that the different calcitic layers of Unit IV formed during interglacials that in southern France correspond to humid temperate conditions [38].

The general reliability of results is shown by agreement on the age of several adjacent samples analyzed at the four different laboratories of the present co-authors. Results (table 2) show that adjacent samples from each growth phase give comparable dates. Finally, the ESR ages obtained on three samples from layers IV4 and IV5 [15] are in agreement with U-series results.

Aknowledgements

We wish to thank Alain Fournier and Christian Perrenoud for the valuable and numerous stratigraphical data. We would like to thank John Fitzpatrick (USGS) and Masashi Kusakabe (USC) for their help in U-series analyses. This work has been partly financed by the French Foreign office.

References

- [1] J. Amossé, R. Bouchez, J.-F. Bruandet, A. Cornu, J. Diebolt, A. Abergel, J.-L. Ma, Contribution to the dating study of stalagmitic deposits of the caune de l'Arago at Tautavel by gamma spectrometry, in: H. de Lumley, J. Labeyrie (Eds), *Absolute dating and Isotope Analysis in Prehistory - Methods and limits*, Prétirage, CNRS, Paris, 1981, pp. 377-378.
- [2] D. Apers, P. De Cannière, R. Debuyst, F. Dejehet, E. Lombard, A criticism of the dating by Electronic paramagnetic resonance (ESR) of the stalagmitic floors of the Caune de l'Arago at Tautavel, in: H. de Lumley, J. Labeyrie (Eds), *Absolute dating and Isotope Analysis in Prehistory - Methods and limits*, Prétirage, CNRS, Paris, 1981, pp. 533-550.
- [3] A. Ascenzi, I. Biddittu, P.F. Cassoli, A.G. Segre, E. Segre-Naldini, A calvarium of late Homo erectus from Ceprano, Italy, *Journal of Human Evolution* 31 (1996) 409-423.
- [4] J.L. Bada, M.-S. Ho, K.A. Kvenvolden, D.J. Blunt, Amino-Acid racemization analyses of fossil bones from caune de l'Arago at Tautavel. in: H. de Lumley, J. Labeyrie (Eds), *Absolute dating and Isotope Analysis in Prehistory - Methods and limits*, Prétirage, CNRS, Paris, 1981, pp. 585-599.
- [5] F.C. Bassinot, L. Labeyrie, E. Vincent, X. Quidelheur, N.J. Shackleton, Y. Lancelot, The astronomical theory of climate and the age of the Brunhes-Matuyama magnetic reversal, *Earth Planet and Science Letter* 126 (1994) 91-108.
- [6] M. Beiner, B. Giengengack, O. Gooma, J.-P. Pupin, Dating by the Fission-Track method on zircon of recent volcanic origin found in the cave deposit of the caune de l'Arago at Tautavel. in: H. de Lumley, J. Labeyrie (Eds), *Absolute dating and Isotope Analysis in Prehistory - Methods and limits*, Prétirage, CNRS, Paris, 1981, pp. 569-575.

[7] J.M. Bermudez De Castro, J.L. Arsuaga, E. Carbonell, A. Rosas, I. Martinez, M. Mosquera, A hominid from the Lower Pleistocene of Atapuerca, Spain : possible ancestor to Neandertals and Modern Humans, *Science* 276 (1997) 1392-1395.

[8] J.L. Bischoff, Uranium-series dating of bones and carbonate deposits of the caune de l'Arago at Tautavel. in: H. de Lumley, J. Labeyrie (Eds), *Absolute dating and Isotope Analysis in Prehistory - Methods and limits*, Prétirage, CNRS, Paris, 1981, pp. 327-349.

[9] J.L. Bischoff, J. Fitzpatrick, U-series dating of impure carbonates : An isochron technique using total-sample dissolution, *Geochimica et Cosmochimica Acta* 55 (1991) 543-554.

[10] J.L. Bischoff, R.J. Rosenbauer, A. Tavano, H. de Lumley, A test of uranium-series dating of fossil tooth enamel : Results from Tournal cave, France, *Applied Geochemistry* 3 (1988) 135-141.

[11] J. Chaline, Les rongeurs de la Caune de l'Arago à Tautavel et leur place dans la biostratigraphie européenne, in: H. de Lumley, J. Labeyrie (Eds), *Absolute dating and Isotope Analysis in Prehistory - Methods and limits*, Prétirage, CNRS, Paris, 1981, pp.193-203.

[12] E. Crégut, La faune de mammifères du gisement pléistocène moyen antérissien de la Caune de l'Arago (Tautavel, Pyrénées-Orientales, France), *Comptes Rendus Académie des Sciences de Paris* 290 (1980) 751-754.

[13] N.C. Debenham, M.J. Aitken, N. Garton, M. Winter, Uranium disequilibrium dating of calcite from the caune de l'Arago at Tautavel, in: H. de Lumley, J. Labeyrie (Eds), *Absolute dating and Isotope Analysis in Prehistory - Methods and limits*, Prétirage, CNRS, Paris, 1981a, pp. 351-354.

[14] N.C. Debenham, M.J. Aitken, A.J. Walton, Thermoluminescence dating of stalagmitic calcite from the caune de l'Arago cave at Tautavel, in: H. de Lumley, J. Labeyrie (Eds), Absolute dating and Isotope Analysis in Prehistory - Methods and limits, Prétirage, CNRS, Paris, 1981b, pp. 409-421.

[15] C. Falguères, Datation des sites acheuléens et moustériens du midi méditerranéen par la méthode de résonance de spin électronique, Thèse de Doctorat, Muséum national d'Histoire naturelle, Paris, 1986, 173p., unpublished.

[16] C. Falguères, G. Shen, Y. Yokoyama, Datation de l'aven d'Orgnac III : comparaison par les méthodes de la résonance de spin électronique (ESR) et du déséquilibre des familles de l'uranium, L'Anthropologie 92 (1988) 727-731.

[17] L. Gabunia, A. Vekua, D. Lordkipanidze, C.C. Swisher III, R. Ferring, A. Justus, M. Nioradze, M. Tvalchrelidze, S.C. Anton, G. Bosinski, O. Jöris, M.A. de Lumley, G. Majsuradze, A. Mouskhelishvili, Earliest Pleistocene Hominid cranial remains from Dmanisi, Republic of Georgia : Taxonomy, geological setting, and age, Science 288 (2000) 1019-1025.

[18] D. Grimaud, Le pariétal de l'Homme de Tautavel, In : 1^{er} Congrès International de Paléontologie Humaine, Nice, (1982) 62-88.

[19] C. Guérin, Les rhinoceros (Mammalia, Perissodactyla) du gisement pléistocène moyen de la caune de l'Arago à Tautavel. Signification stratigraphique, in: H. de Lumley, J. Labeyrie (Eds), Absolute dating and Isotope Analysis in Prehistory - Methods and limits, Prétirage, CNRS, Paris, 1981, pp. 163-191.

[20] C. Guérin, M. Faure, Biochronologie et datations absolues: convergence des méthodes dans différents sites du Paléolithique ancien, Revue d'Archéométrie 15 (1991) 41-46.

[21] G.J. Hennig, W. Herr, E. Weber, Electron Spin Resonance (ESR) dating of speleothem of the caune de l'Arago at Tautavel. Notes on problems and progress, in: H. de Lumley, J. Labeyrie (Eds), Absolute dating and Isotope Analysis in Prehistory - Methods and limits, Prétirage, CNRS, Paris, 1981, pp. 551-556.

[22] M. Ikeya, New applications of Electron Spin Resonance: Dating, dosimetry and microscopy, World Scientific, Singapore, 1993.

[23] M. Ikeya, T. Miki, Archaeological dose of Arago and Choukoutien materials with Electron Spin Resonance (ESR), in: H. de Lumley, J. Labeyrie (Eds), Absolute dating and Isotope Analysis in Prehistory - Methods and limits, Prétirage, CNRS, Paris, 1981, pp. 493-505.

[24] M. Ivanovich, R.S. Harmon, Uranium-series Disequilibrium : Applications to Earth, Marine and Environmental Sciences, 2nd Edition. Oxford, Clarendon Press, 1992.

[25] T.L. Ku, Z.C. Liang, The dating of impure carbonates with decay-series isotopes, Nucl. Instr. Meth. Phys. Res. 223 (1984) 563-571.

[26] J. Labeyrie, C. Lalou, Limits and hopes of the uranium-ionium (^{230}Th) methods, in: H. de Lumley, J. Labeyrie (Eds), Absolute dating and Isotope Analysis in Prehistory - Methods and limits, Prétirage, CNRS, Paris, 1981, pp. 265-297

[27] C. Lalou, C-T. Hoang, Problems connected with the $^{230}\text{Th}/^{234}\text{U}$ dating of the cave deposit of the caune de l'Arago at Tautavel, in: H. de Lumley, J. Labeyrie (Eds), Absolute dating and Isotope Analysis in Prehistory - Methods and limits, Prétirage, CNRS, Paris, 1981, pp. 299-313.

[28] H. de Lumley, A. Fournier, Y.C. Park, Y. Yokoyama, A. Demouy, Stratigraphie du remplissage pléistocène moyen de la caune de l'Arago à Tautavel. Etude de huit carottages effectués de 1981 à 1983, L'Anthropologie 88 n°1 (1984) 5-18.

[29] H. de Lumley, J. Labeyrie, Absolute dating and Isotope Analysis in Prehistory - Methods and limits, Prétirage, 720 pp, CNRS, Paris, 1981.

[30] H. de Lumley, M.-A. de Lumley, A. Fournier, La mandibule de l'Homme de Tautavel, In : 1^{er} Congrès International de Paléontologie Humaine, Nice, (1982) 178-221.

[31] H. de Lumley, Y.C. Park, A. Camara, V. Geleijnse, M. Beiner, A. Fournier, J.C. Miskovsky, M. Hoffert, O. Schaaf, Caractéristiques sédimentologiques et minéralogiques du remplissage quaternaire de la Caune de l'Arago à Tautavel, origine et mise en place des sédiments, in: H. de Lumley, J. Labeyrie (Eds), Absolute dating and Isotope Analysis in Prehistory - Methods and limits, Prétirage, CNRS, Paris, 1981, pp. 43-73.

[32] M.-A. de Lumley, L'Homme de Tautavel. Critères morphologiques et stade évolutif, in: H. de Lumley, J. Labeyrie (Eds), Absolute dating and Isotope Analysis in Prehistory - Methods and limits, Prétirage, CNRS, Paris, 1981, pp. 259-264.

[33] A.M. Moigne, V. Belda, D. Briki, S. Kacimi, F. Lacomat, J. Moutoussamy, J. Quiles, F. Rivals, A. Testu, Les faunes de grands mammifères du Pléistocène moyen de la Caune de l'Arago (complexe stratigraphique moyen) à Tautavel. Leur place dans le cadre biostratigraphique et paléoclimatique du Quaternaire. Les horizons biostratigraphiques Arago CMI, CMII et CMIII, Colloque International de Tautavel, oral communication, 2000.

[34] M. Ohta, Thermoluminescence dating of stalagmitic calcite from the caune de l'Arago at Tautavel, in: H. de Lumley, J. Labeyrie (Eds), Absolute dating and Isotope Analysis in Prehistory - Methods and limits, Prétirage, CNRS, Paris, 1981, pp. 423-436.

[35] H.A. Potratz, J.W. Barnes, E.J. Lang, A radiochemical procedure for thorium and its application in the determination of ionium in coral limestones, Los Alamos Science Laboratory IA-1845 (1955) 19.

[36] J.-P. Quaegebeur, Y. Yokoyama, Etude par al résonance de spin électronique (ESR) des grains de quartz de la caune de l'Arago à Tautavel, in: H. de Lumley, J. Labeyrie (Eds), Absolute dating and Isotope Analysis in Prehistory - Methods and limits, Prétirage, CNRS, Paris, 1981, pp. 557-564.

[37] W.J. Rink, Electron spin resonance (ESR) dating and ESR applications in Quaternary science and archaeometry, Radiation Measurements 27 n°5-6 (1997) 975-1025.

[38] L. Rousseau, F. Robert, H. de Lumley, J.J. Bahain, C. Falguères, Analyse de la composition isotopique ($\delta^{18}O$) du plancher stalagmitique supérieur de la grotte du Lazaret à Nice, C.R. Acad. Sci. Paris 318 (1994) 783-786.

[39] N.W. Rutter, R.J. Crawford, Z. Kiparissides, Relative dating of bones by D/L ratios of amino acids from the caune de l'Arago at Tautavel, in: H. de Lumley, J. Labeyrie (Eds), Absolute dating and Isotope Analysis in Prehistory - Methods and limits, Prétirage, CNRS, Paris, 1981, pp. 601-607.

[40] H.P. Schwarcz, Uranium-series dating of travertines from the Caune de l'arago at Tautavel, in: H. de Lumley, J. Labeyrie (Eds), Absolute dating and Isotope Analysis in Prehistory - Methods and limits, Prétirage, CNRS, Paris, 1981, pp. 533-550.

[41] G. Shen, Datation du remplissage de la caune de l'Arago par la méthode $^{230}Th/^{234}U$ et contribution à la méthodologie, Thèse de Doctorat, Université Pierre et Marie Curie, Paris VI, 1983, 90p., unpublished,.

[42] G. Shen, Datation des planchers stalagmitiques de sites acheuléens en Europe par les méthodes des déséquilibres des familles de l'uranium et contribution méthodologique, Thèse de Doctorat d'Etat, Université Pierre et Marie Curie, Paris VI, 1985, 162p., unpublished.

[43] G.G. Smith, E.D. Stroud, A.C. Bazan, M.K. Jenkins, Application of amino acid racemization studies to geochronology of the fossil bones of the caune de l'Arago at Tautavel. Scope and limitation, in: H. de Lumley, J. Labeyrie (Eds), Absolute dating and Isotope Analysis in Prehistory - Methods and limits, Prétirage, CNRS, Paris, 1981, pp. 609-635.

[44] J. Spitey, Le frontal de l'Homme de Tautavel, In : 1^{er} Congrès International de Paléontologie Humaine, Nice (1982) 21-61.

[45] K. Turekian, J.K. Cochran, Dating by the radioactive disequilibrium of uranium content in the stalagmite floors of the caune de l'Arago at Tautavel, in: H. de Lumley, J. Labeyrie (Eds), Absolute dating and Isotope Analysis in Prehistory - Methods and limits, Prétirage, CNRS, Paris, 1981, pp. 317-325.

[46] G. Valladas, H. Valladas, J.-C. Massot, Datations par la thermoluminescence et la résonance paramagnétique électronique de quelques planchers stalagmitiques de la caune de l'Arago à Tautavel, in: H. de Lumley, J. Labeyrie (Eds), Absolute dating and Isotope Analysis in Prehistory - Methods and limits, Prétirage, CNRS, Paris, 1981, pp. 391-401.

[47] Y. Yokoyama, J. Carpena, Les traces de fission des zircons de volcanisme récent provenant de la caune de l'Arago à Tautavel: révélation des traces de fission naturelle de l'uranium-238, in: H. de Lumley, J. Labeyrie (Eds), Absolute dating and Isotope Analysis in Prehistory - Methods and limits, Prétirage, CNRS, Paris, 1981, pp. 565-568.

[48] Y. Yokoyama, C. Falguères, J.P. Quaegebeur, ESR dating of quartz from quaternary sediments : first attempt, Nuclear Tracks 10 (1985) 921-928.

[49] Y. Yokoyama, H.V. Nguyen, Datation directe par la spectrométrie gamma non destructive du crâne humain fossile Arago XXI, des ossements fossiles d'animaux et des stalagmites de la caune de l'Arago à Tautavel, in: H. de Lumley, J. Labeyrie (Eds), Absolute dating and Isotope Analysis in Prehistory - Methods and limits, Prétirage, CNRS, Paris, 1981a, pp. 355-375.

[50] Y. Yokoyama, H.V. Nguyen,. Datation directe de l'Homme de Tautavel par la spectrométrie gamma, non destructive, du crâne humain fossile Arago XXI, Comptes Rendus Académie des Sciences de Paris 292 (1981b) 741-744.

[51] Y. Yokoyama, J.P. Quaegebeur, R. Bibron, C. Léger, H.V. Nguyen, G. Poupeau, Electron spin resonance (ESR) dating of bones of the caune de l'Arago at Tautavel, in: H. de Lumley, J. Labeyrie (Eds), Absolute dating and Isotope Analysis in Prehistory - Methods and limits, Prétirage, CNRS, Paris, 1981a, pp. 457-492.

[52] Y. Yokoyama, J.P. Quaegebeur, R. Bibron, C. Léger, H.V. Nguyen, G. Poupeau, Electron spin resonance (ESR) dating of stalagmites of the caune de l'Arago at Tautavel, in: H. de Lumley, J. Labeyrie (Eds), Absolute dating and Isotope Analysis in Prehistory - Methods and limits, Prétirage, CNRS, Paris, 1981b, pp. 507-532.

[53] Y. Yokoyama, J.P. Quaegebeur, R. Bibron, C. Léger, H.V. Nguyen, G. Poupeau, Datation du site de l'Homme de Tautavel par la résonance de spin électronique (ESR), Comptes Rendus Académie des Sciences de Paris 294 (1982) 759-764.

Figure and photo caption

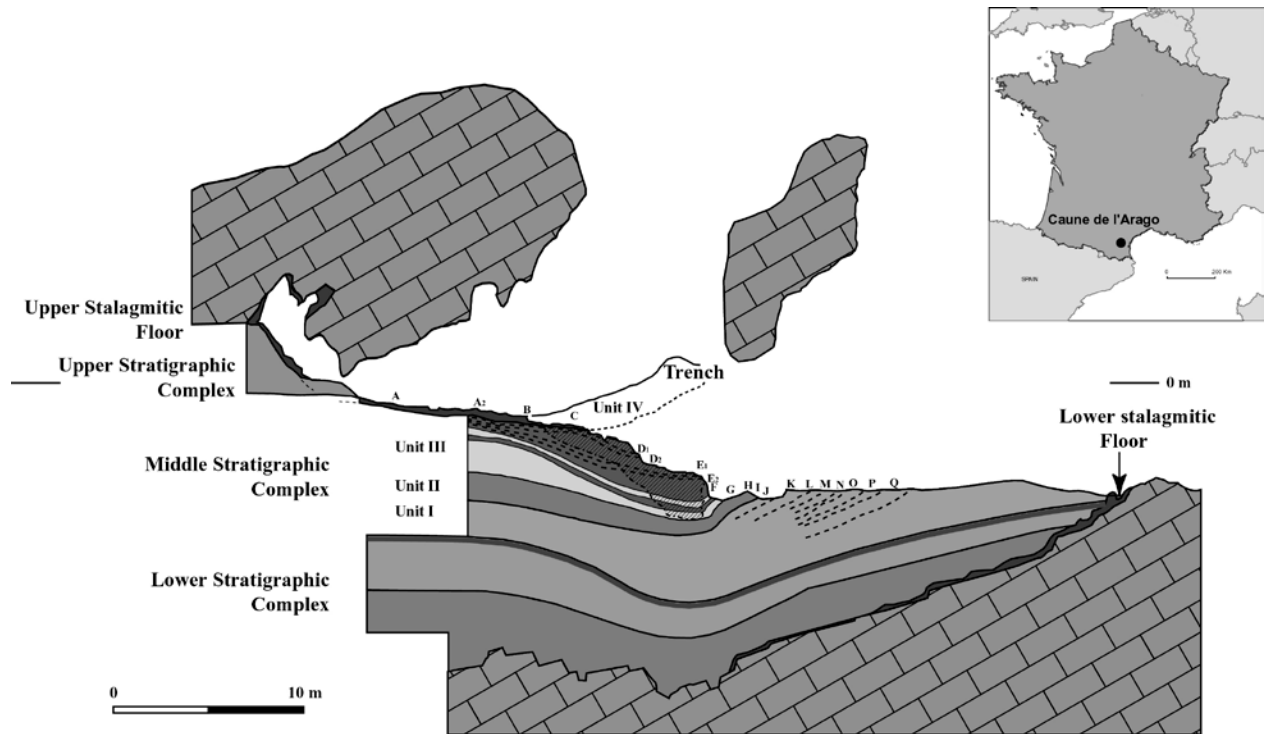
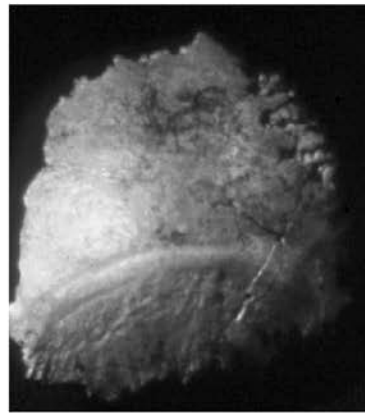

Figure 1 : Location map and synthetic stratigraphic section of the Caune de l'Arago, after de Lumley et al., [28].



a)



b)



c)



d)

Photo 1 : Principal human fossils found at Arago cave ; a) Arago XXI skull discovered in 1971, b) Arago XLVII parietal discovered in 1979, c) Arago II mandible, d) Arago XIII mandible, (photos de Lumley).

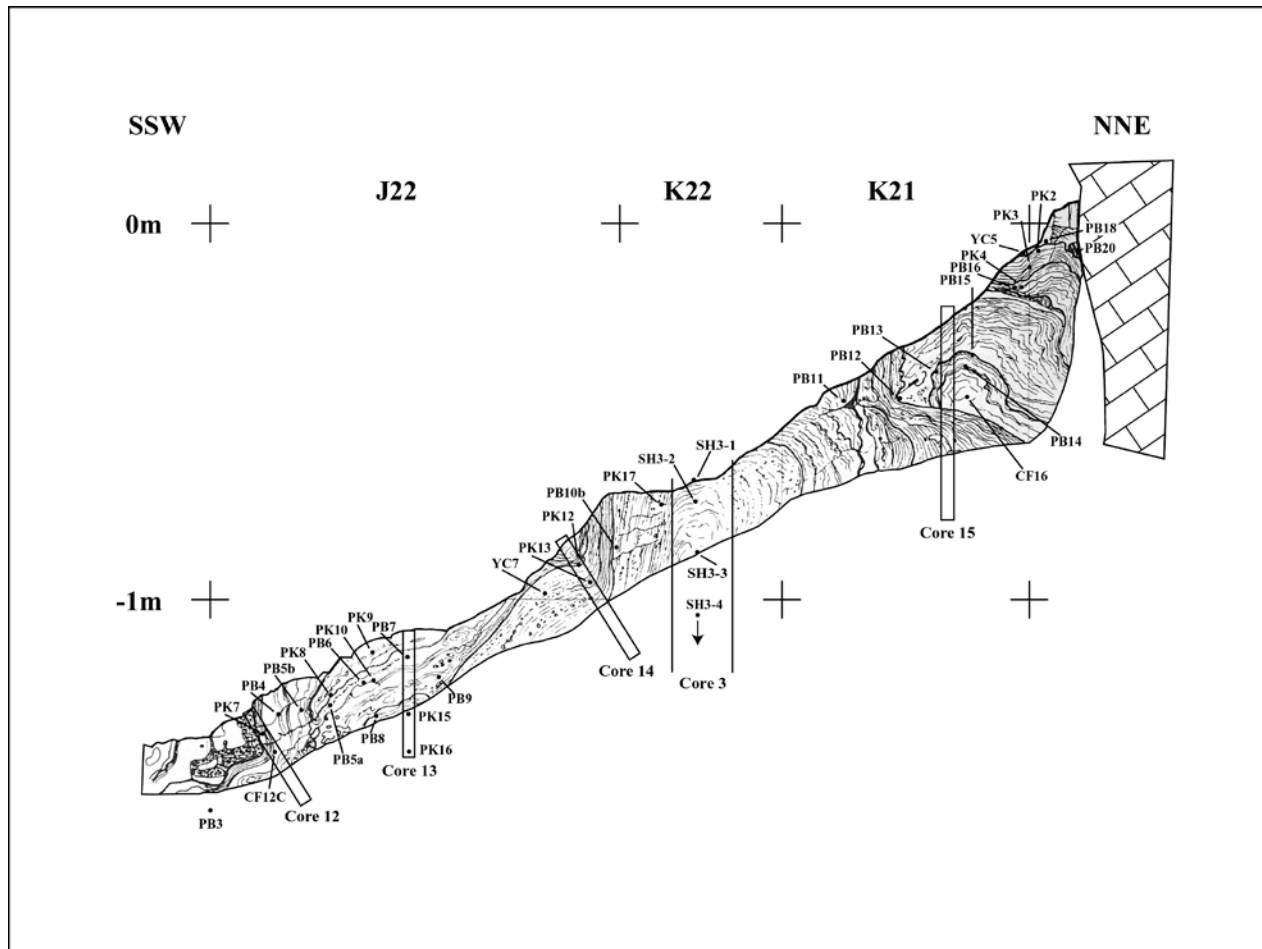

Figure 2 : Section of basal stalagmite of Unit IV showing microstratigraphy and location of analyzed samples in northern stalagmitic column, western wall of the trench, Caune de l'Arago.

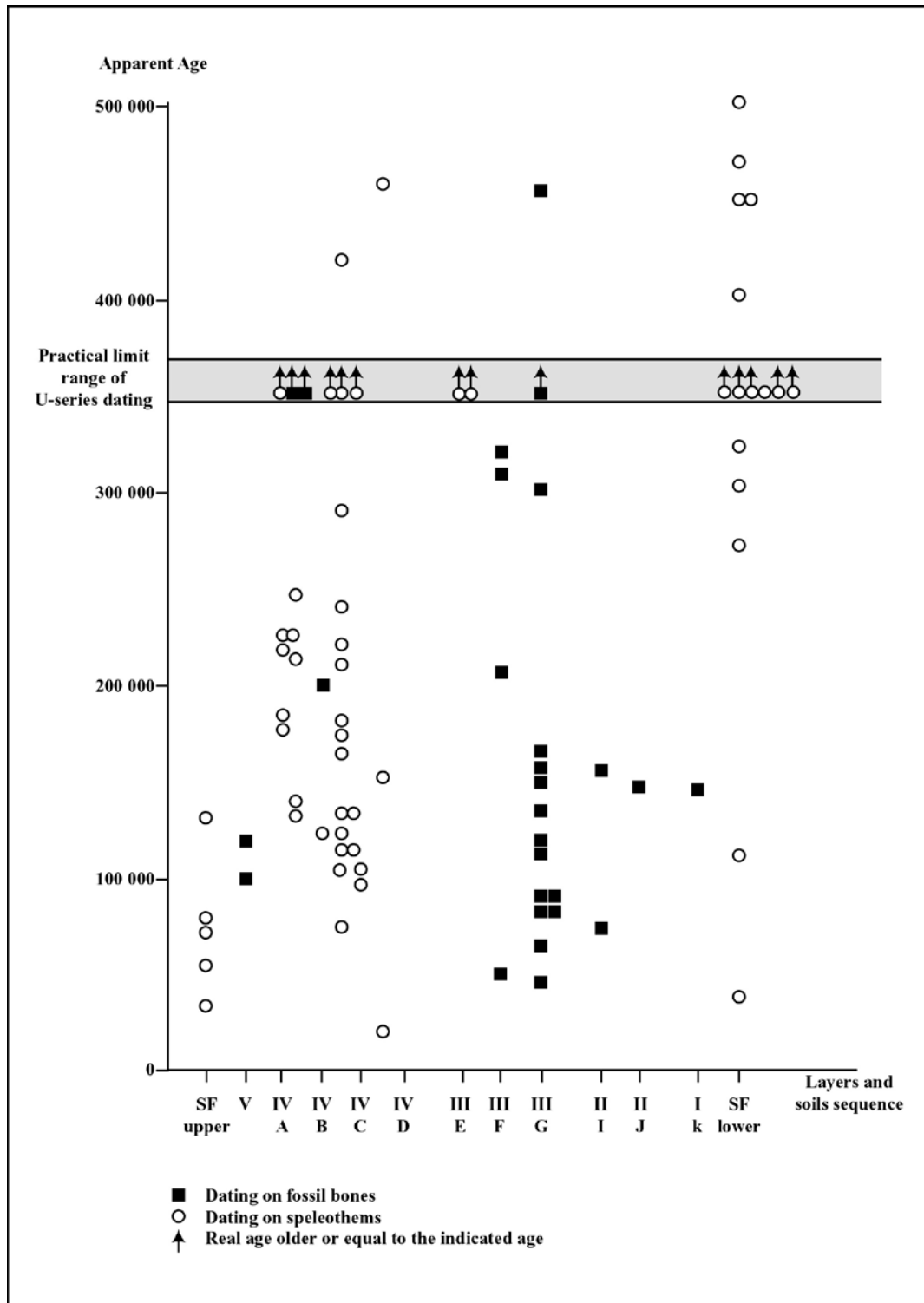

Figure 3 : Spread of U-series ages reported on bones and speleothems at the Colloquium of 1981, after Shen, [42].

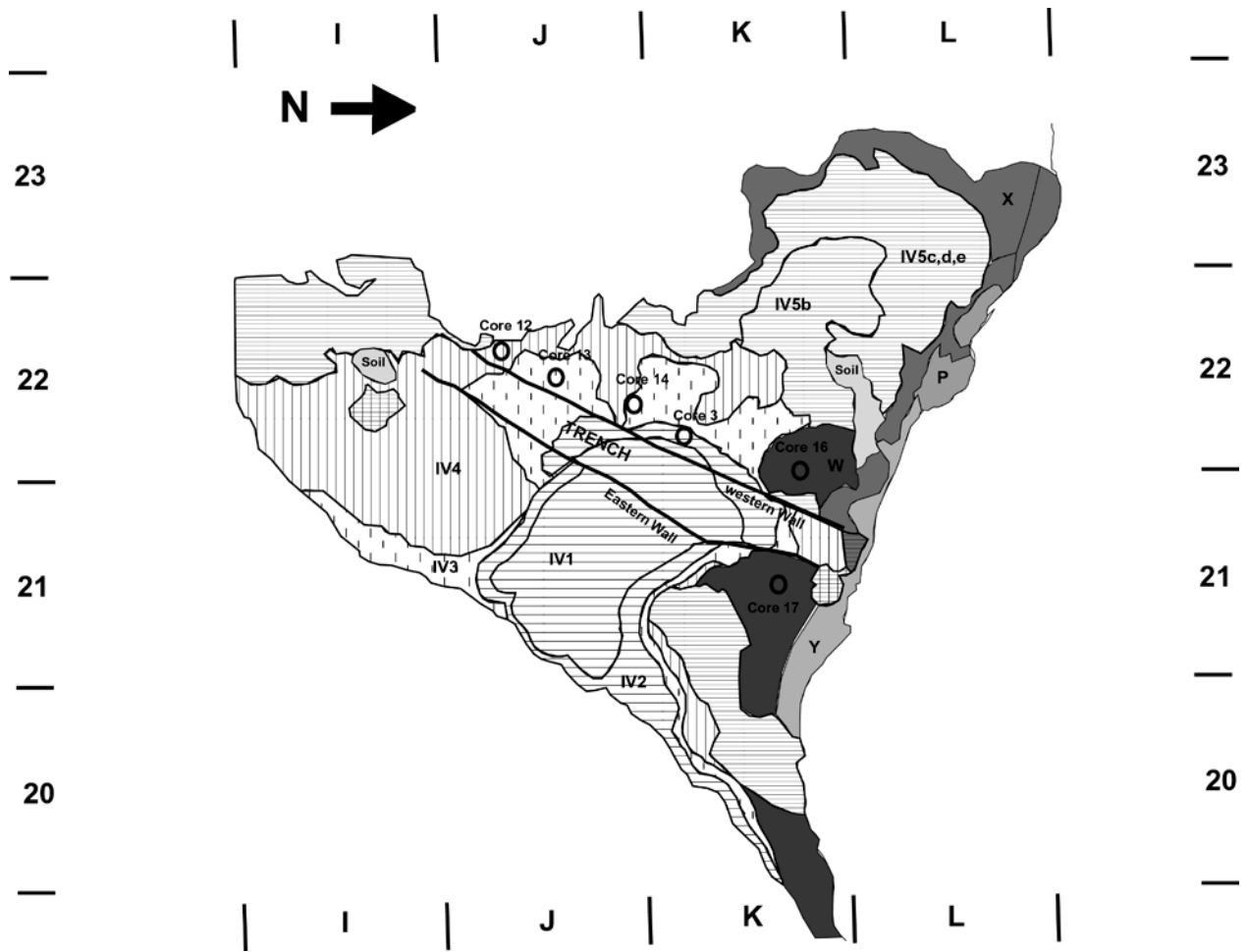

Figure 4 : Plan view of extent of various growth calcite phases of northern stalagmitic column. The trench is represented by bold lines with the limits of western and eastern walls (modified from de Lumley and Fournier, unpublished).

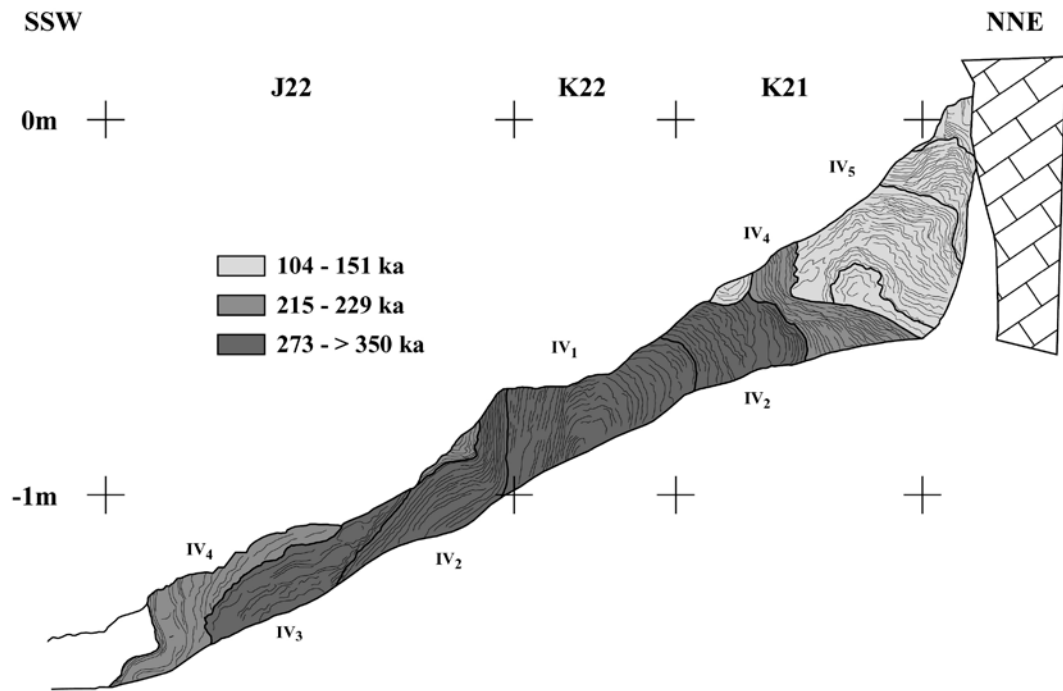

Figure 5 : Section-drawing of northern stalagmitic column showing the different microstratigraphic layers.

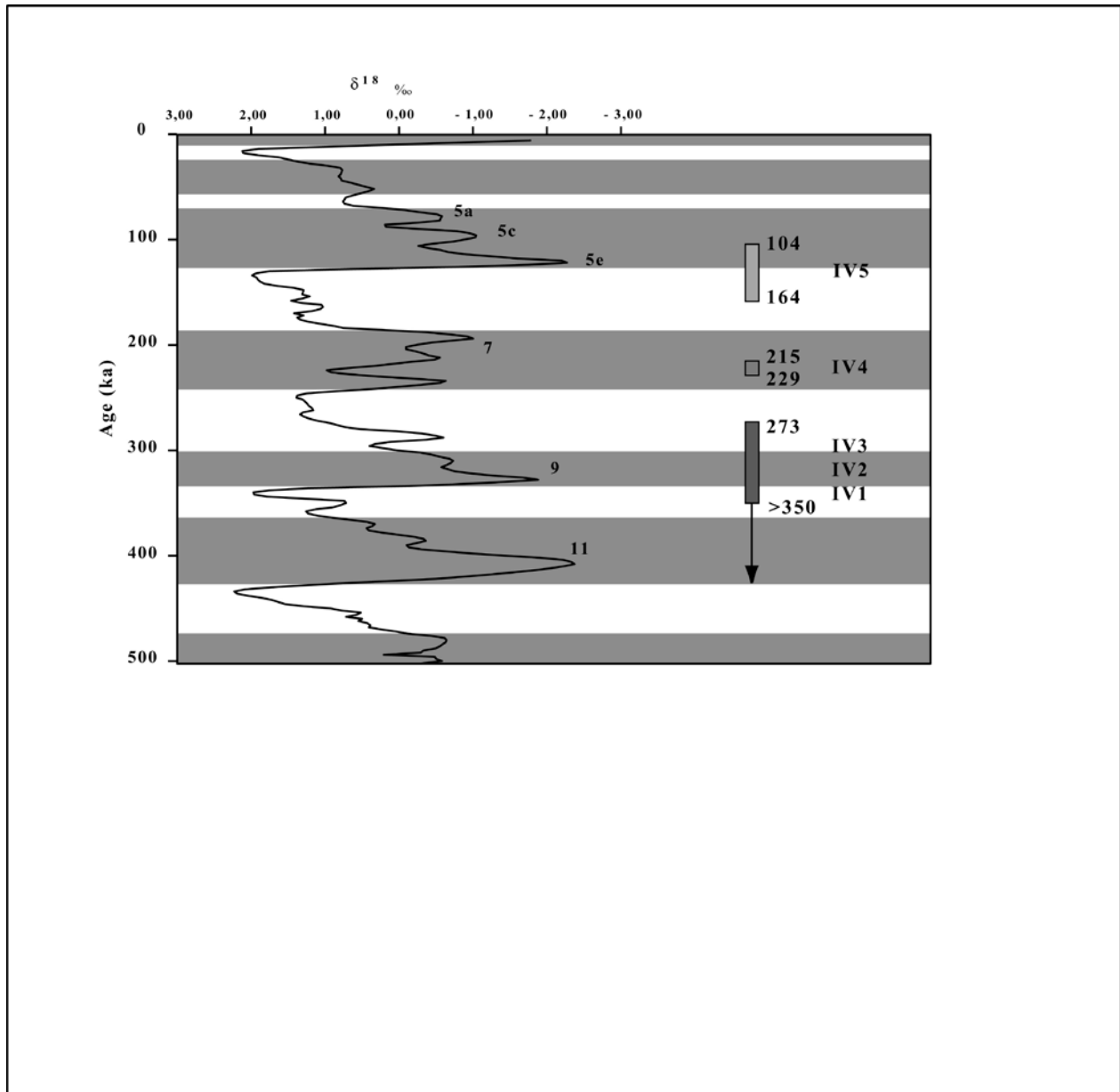

Figure 6 : Dates of calcite units of level IV stalagmitic column plotted along with marine isotope curve [5]. Grouping of dates suggest stalagmite growth primarily occurred during interglacials.

Table 1: uranium content, isotopic ratios and ages of studied samples in stalagmitic northern column
 USGS = samples analysed at the Geological Survey of Menlo Park, United States;
 USC = University of Southern California, United States; CFR = Centre des Faibles Radioactivités, France

USGS	USC	CFR (ESR)	CFR (U- Th)	Zone	Uppm	$^{234}\text{U}/^{238}\text{U}$	$^{230}\text{Th}/^{234}\text{U}$	$^{230}\text{Th}/^{232}\text{Th}$ h	DATE ka
				I22	0.34	1.13 ± 0.03	1.10 ± 0.04	8	> 350
				J22	0.60	1.07 ± 0.02	0.97 ± 0.03	30	321 +202 - 69
				J22	0.14	1.03 ± 0.04	1.10 ± 0.05	37	> 350
				J22	0.27	1.07 ± 0.03	0.88 ± 0.04	85	215 +84 -48
				J22	0.29	1.09 ± 0.02	1.03 ± 0.03	11	> 350
				J22	1.49	1.06 ± 0.01	0.97 ± 0.03	15	336 +141 -91
				J22	0.55	1.00 ± 0.02	0.97 ± 0.03	7	> 350
				J22	0.58	1.09 ± 0.02	0.90 ± 0.03	23	235 +71 -43
				J22	0.65	1.09 ± 0.01	0.96 ± 0.02	27	300 +39 -26
				K21	1.38	1.17 ± 0.01	0.69 ± 0.02	19	122 +13 -12
				K21	0.35	1.07 ± 0.02	0.89 ± 0.03	12	229 +52 -35
				K21	0.67	1.14 ± 0.02	0.67 ± 0.02	24	118 +12 -11
				K21	0.59	1.14 ± 0.02	0.68 ± 0.02	22	120 +12 -11
				K21	0.26	1.13 ± 0.02	0.63 ± 0.02	18	104 +10 -9
				K21	0.29	1.06 ± 0.03	0.77 ± 0.02	15	157 +12 -10
				K21	0.51	1.06 ± 0.03	0.73 ± 0.02	>100	139 +10 -8
				L21	0.51	1.16 ± 0.04	0.80 ± 0.03	30	164 +14 -11
				I22	0.89	1.02 ± 0.02	0.98 ± 0.04	7	> 350
				L21	0.52	1.14 ± 0.02	0.76 ± 0.03	21	149 +21 -17
				K21	0.33	1.17 ± 0.02	0.69 ± 0.03	19	122 +17 -14
	PK2			L21	0.28	1.16 ± 0.03	0.68 ± 0.02	76	119 ± 5
	PK3			L21	0.25	1.11 ± 0.02	0.77 ± 0.01	62	151 ± 6
	PK4			K21	0.33	1.13 ± 0.04	0.88 ± 0.02	79	209 +17 -15
	PK5			K21	0.28	1.11 ± 0.03	0.71 ± 0.02	77	130 +6 -5
	PK6			K21	0.18	1.13 ±	0.74 ±	9	141 ± 12

				0.05	0.03		
PK7		J22	0.20	1.07 ±	0.73 ±	18	140 ± 13
				0.04	0.04		
PK8		J22	0.16	1.06 ±	0.89 ±	23	226 +21 -18
				0.03	0.02		
PK9		J22	0.27	1.06 ±	0.76 ±	14	152 ± 12
				0.05	0.03		
PK10		J22	1.84	1.03 ±	0.97 ±	31	354 +110 -54
				0.03	0.03		
PK12		J22	0.13	1.08 ±	0.94 ±	16	273 +50 -35
				0.04	0.03		
PK13		J22	0.14	1.07 ±	0.95 ±	16	289 +50 -35
				0.04	0.03		
PK15		J22	1.74	1.12 ±	1.00 ±	73	368 +133 -61
				0.04	0.03		
PK16		J22	1.23	1.19 ±	1.09 ±	50	> 550
				0.03	0.03		
PK17		K22	0.28	1.10 ±	1.00 ±	16	383 +ind. -91
				0.03	0.04		
	CF12C	J22					224 ± 31
	CF16	K21					159 ±17
	CF17A	K21					157 ± 22
				1.12 ±	1.00 ±		
	SH3-1	K22	0.23	0.03	0.04	35	369 +139 -87
				1.09 ±	1.06 ±		
	SH3-2 (1)	K22	0.28	0.03	0.04	49	> 350
				1.06 ±	1.01 ±		
	SH3-2 (2)		0.28	0.03	0.04	31	> 317
				1.06 ±	1.13 ±		
	SH3-3 (1)	K22	0.21	0.02	0.05	23	> 350
				1.14 ±	0.99 ±		
	SH3-3 (2)		0.22	0.04	0.04	35	330 +203 -67
				1.12 ±	1.05 ±		
	SH3-4	K22	3.30	0.02	0.04	70	> 350
				1.11 ±	0.68 ±		
	YC5 (1)	K21	0.33	0.03	0.03	> 200	119 +11 -10
				1.11 ±	0.73 ±		
	YC5 (2)		0.36	0.03	0.03	> 100	138 +12 -11
				1.07 ±	0.98 ±		
	YC7 (1)	J22	0.30	0.01	0.02	26	341 +55 -36
				1.06 ±	1.04 ±		
	YC7 (2)		0.31	0.01	0.03	16	> 350
				1.04 ±	1.13 ±		
	YC7 (3)		0.30	0.01	0.02	17	> 350
				1.06 ±	1.04 ±		
	YC7 (4)		0.31	0.04	0.05	19	> 350

Table 2 : Some examples showing good interlab comparability for samples having a very close location
 x= horizontal coordinate; z = vertical coordinate measured from "absolute zero"

Samples	Square	x (cm)	z (cm)	Date (ka)
IV1 and IV2				
PK17	K22	10	-75	383 +indet / -91
SH3-1	K22	17	-68	369 +139 / -87
PB10B	J22	99	-87	300 +39 / -26
IV4				
PK8	J22	30	-125	226 ± 20
PB5B	J22	23	-129	215 +84 / -48
CF12C	J22	35	-120	224 ± 31
IV5				
PK5	K21	90	6	130 ± 5
YC5 (2)	K21	97	-4	138 +12 / -11
PB17	K21	87	-13	139 +10 / -8
CF17A	K21	97	-5	157 ± 22