



HAL
open science

Oxidation and reduction of actin: Origin, impact in vitro and functional consequences in vivo

Clémentine Rouyère, Thomas Serrano, Stéphane Frémont, Arnaud Echard

► To cite this version:

Clémentine Rouyère, Thomas Serrano, Stéphane Frémont, Arnaud Echard. Oxidation and reduction of actin: Origin, impact in vitro and functional consequences in vivo. *European Journal of Cell Biology*, 2022, 101 (3), pp.151249. 10.1016/j.ejcb.2022.151249 . hal-03856293

HAL Id: hal-03856293

<https://cnrs.hal.science/hal-03856293>

Submitted on 16 Nov 2022

HAL is a multi-disciplinary open access archive for the deposit and dissemination of scientific research documents, whether they are published or not. The documents may come from teaching and research institutions in France or abroad, or from public or private research centers.

L'archive ouverte pluridisciplinaire **HAL**, est destinée au dépôt et à la diffusion de documents scientifiques de niveau recherche, publiés ou non, émanant des établissements d'enseignement et de recherche français ou étrangers, des laboratoires publics ou privés.



Distributed under a Creative Commons Attribution - NonCommercial 4.0 International License

**Oxidation and reduction of actin:
origin, impact *in vitro* and functional consequences *in vivo***

Clémentine Rouyère^{1,2*}, Thomas Serrano^{1*}, Stéphane Frémont^{1**} and Arnaud Echard^{1**}

¹ Institut Pasteur, Université Paris Cité, CNRS UMR3691, Membrane Traffic and Cell Division Unit, 25-28 rue du Dr Roux, F-75015 Paris, France

² Sorbonne Université, Collège doctoral, F-75005 Paris, France

* and **: equal contributions

Correspondence: arnaud.echard@pasteur.fr

Abstract

Actin is among the most abundant proteins in eukaryotic cells and assembles into dynamic filamentous networks regulated by many actin binding proteins. The actin cytoskeleton must be finely tuned, both in space and time, to fulfil key cellular functions such as cell division, cell shape changes, phagocytosis and cell migration. While actin oxidation by reactive oxygen species (ROS) at non-physiological levels are known for long to impact on actin polymerization and on the cellular actin cytoskeleton, growing evidence shows that direct and reversible oxidation/reduction of specific actin amino acids plays an important and physiological role in regulating the actin cytoskeleton. In this review, we describe which actin amino acid residues can be selectively oxidized and reduced in many different ways (e.g. disulfide bond formation, glutathionylation, carbonylation, nitration, nitrosylation and other oxidations), the cellular enzymes at the origin of these post-translational modifications, and the impact of actin redox modifications both *in vitro* and *in vivo*. We show that the regulated balance of oxidation and reduction of key actin amino acid residues contributes to the control of actin filament polymerization and disassembly at the subcellular scale and highlight how its improper redox modifications of actin can lead to pathological conditions.

Introduction

Globular actin (G-actin) is a 375 amino acid protein which is highly conserved in all eukaryotic cells and a major component of the cellular cytoskeleton. Thanks to interactions with numerous actin binding proteins (ABPs), G-actin can assemble in a dynamic and reversible manner into filaments (F-actin) which are incorporated to complex subcellular networks (Gautreau et al., 2022; Pollard, 2016). As a consequence, the actin cytoskeleton and associated proteins play crucial roles in the establishment, maintenance and changes in cell shape, motility and contractility, in cell division, in intracellular trafficking and polarity, in cell-cell junctions and epithelial architecture. While ABPs play an essential role in controlling F-actin nucleation, polymerization, disassembly, severing and network formation in linear and branched arrays, it is now well established that direct post-translational modifications (PTMs) of actin also play important regulatory roles.

Various actin PTMs have been identified and detailed in comprehensive reviews (Terman and Kashina, 2013; Varland et al., 2019). They include acetylation, phosphorylation, SUMOylation, ubiquitination, ADP-ribosylation, arginylation and methylation, some PTMs being isoform specific. Indeed, 6 highly-related yet distinct isoforms of actin are expressed in muscles (α -cardiac, α -skeletal, α -smooth, γ -smooth actins) or in non-muscle cells (β -cytoplasmic and γ -cytoplasmic actins) in mammals, with differences mostly located in the N-termini (Perrin and Ervasti, 2010). In addition to the aforementioned PTMs, growing evidence indicates that actin undergoes redox modifications due to oxidation and reduction of specific residues, in particular a subset of cysteines and methionines. These redox modifications can be reversible (such as glutathionylation, disulfide bond formation and other oxidations) or irreversible (such as nitration and carbonylation).

Redox reactions involve chemical species that exchange electrons and therefore modify their oxidation states (Sies and Jones, 2020). Physiological, low and regulated levels of oxidants in cells, also called *oxidative eustress*, play a major signalling role by reversibly modifying specific amino acids in targeted proteins, including actin. Redox-dependent signalling is achieved by redox-dependent changes in protein conformation, localization, activity and/or interactions with partners. In contrast, excessive oxidant levels in cells, also referred as *oxidative distress*, lead to unspecific protein oxidation, altered signalling and reversible or irreversible protein damage. Of note, oxidative distress not only affects

proteins but also DNA, RNA and lipids, which can, in turn, act as oxidant signals for proteins (Sies and Jones, 2020). To avoid the aforementioned deleterious effects and ensure proper signalling roles, oxidant production must be tightly controlled in space and time and balanced by reduction systems.

In this review, we will first describe which actin residues are selectively targeted by different redox modifications. We will detail the chemical species that can oxidize actin in cells and the enzymes that control their local production. Next, we will review the consequences of actin oxidation in animal cells by diffusing redox species, both *in vitro* and *in vivo*. In a third part, we will focus on the reversible and direct oxidation/reduction of actin Met44 and Met47 controlled by enzymes of the MICAL and SelR/MsrB families, at the structural, biochemical, cellular and developmental levels. We will see that, depending on the amino acid, the nature of the redox modification, the association of ions or ABPs and the G- vs. F- state of actin, the outcome of actin oxidation/reduction on the actin cytoskeleton are different. These modifications can indeed regulate actin polymerization/depolymerization, degradation/aggregation and interactions with ABPs. The readers are invited to consult previous excellent reviews on actin/ABP oxidation, often with a specific angle such as in neuronal function (Wilson et al., 2016b), cell migration (Balta et al., 2020), cardiovascular biology (Cuello et al., 2018; Xu et al., 2017) and age-related diseases (Castro et al., 2013). We will here emphasize the latest findings and also the various reduction systems that balance oxidation and that are rarely reviewed in the context of actin oxidation. We will also describe the newly reported biosensors that have been developed to visualize the local production of oxidizing species that target actin and the challenges ahead in the field of actin oxidation. It will become apparent that the physiological oxidation and the local redox balance represent key aspects of the spatio-temporal regulation of the cellular actin cytoskeleton.

I- Actin is a major target of oxidoreduction

Actin amino acid residues modified by redox PTMs

Actin can be oxidized by various oxidant species. A key source of oxidants in cells are Reactive Oxygen Species (ROS), which are oxygen-containing molecules formed by redox reactions. The major cellular ROS are the hydrogen peroxide (H_2O_2) and the superoxide anion radicals ($O_2^{\cdot-}$), although other molecules exist such as lipid peroxides (R-O-OH), peroxy radicals (R-O-O \cdot), hypochlorous acid (HOCl) and hydroxyl radicals (HO \cdot). Cells also contain Reactive Nitrogen Species (RNS) and Reactive Sulfur Species (RSS) (Cortese-Krott et al., 2017) but we will focus essentially on the consequences of ROS on actin, which have been more studied. As described below in detail, several actin amino acid residues can be oxidized in several distinct ways, in a reversible or irreversible manner (**Fig. 1** and reviewed in detail in (Terman and Kashina, 2013; Varland et al., 2019; Wilson et al., 2016b; Xu et al., 2017)).

Cysteine modifications are the best characterized redox PTMs in actin (**Fig. 2A**). Cysteines readily react with H_2O_2 , the most abundant cellular ROS. However, each cysteine's environment and exposure determine its rate of reaction with H_2O_2 , explaining why specific cysteines can be oxidized. The cysteine thiol group (-SH) can be reversibly oxidized into sulfenic acid (-SOH) and sulfinic acid (-SOOH), and irreversibly oxidized into sulfonic acid (-SOOOH) (**Fig. 1**). The sulfenic acid is unstable and is quickly converted into disulfide (through intra- or inter-molecular disulfide bonds) or glutathionylated in the presence of thiol and cellular glutathione (GSH), respectively. The cysteine thiol group can also be directly oxidized into intra- or inter-molecular disulfide, or experience glutathionylation (**Fig. 1**). Furthermore, the cysteine thiol can undergo reversible S-nitrosylation, an oxidation reaction mediated by nitric oxide (NO) (**Fig. 1**). S-nitrosothiol can further be converted by glutathionylation. Finally, cysteines can be irreversibly modified by carbonylation (**Fig. 1**).

In vitro studies have shown that cysteines of actin are highly reactive to a broad range of reagents among which ROS, RNS and peroxidized lipids. All actin cysteines are susceptible to oxidation *in vitro* but the number of these residues varies. Non-muscle β and γ actins, as well as smooth α and γ actins, have six cysteine residues whereas skeletal and cardiac α actins have five (**Fig. 2A**). However, the most reactive cysteine is Cys374, at the C-terminal extremity of actin. To illustrate the reactivity of Cys374, it is noteworthy that freezing and thawing, as well as aging of purified actin results in Cys374 oxidation (Ishiwata,

1976; Tang et al., 1999). Because of its outstanding reactivity, Cys374 is the target of pyrene labelling, which is widely used to follow actin polymerization (Kouyama and Mihashi, 1981). Of note, labelling of Cys374 with pyrene or other fluorescent molecules alters the interaction of actin with ABPs (such as cofilin) and should be used at low concentration and with caution. Cys374 can undergo various types of redox PTMs depending on the oxidant and on its chemical environment: oxidation to sulfenic, sulfinic and sulfonic acids, glutathionylation, nitrosylation and carbonylation (**Fig. 2A**). Cys374 oxidation can eventually result in the formation of intra-molecular disulfide bond with Cys285 (Farah et al., 2011) or inter-molecular disulfide bonds with other actin molecules (Farah et al., 2011; Ishiwata, 1976; Lassing et al., 2007). Interestingly, Cys374 is located at the interaction site of the ABP profilin and its oxidation regulates its binding (see below).

Methionines in actin also constitute major targets of reversible oxidations into methionine sulfoxides upon reaction with diffusible ROS, such as H₂O₂ (leading to both R and S stereoisomers) (**Fig. 2A**). Methionine sulfoxide formation can also be controlled by specific cellular oxidases (leading to the R-stereoisomer only) (**Fig. 1** and section III). Further oxidation of methionine sulfoxide into methionine sulfone is however irreversible (**Fig. 1**). At physiological pH, methionines do not react as quickly as cysteines with H₂O₂ (Kim et al., 2014). However, methionines can easily react with other oxidants, such as hypochlorous acid (Dalle-Donne et al., 2001). Consequently, many methionines are found oxidized *in vitro* (**Fig. 2A**), essentially leading to methionine sulfoxides and sometimes to methionine sulfones as in the case of Met85 (Fedorova et al., 2010). Structurally, Met44 and Met47 sulfoxides are of special interest because they are located in the D-loop of the subdomain 2 of actin, which is an important region involved in actin subunit contacts in actin filaments (Dominguez and Holmes, 2011) (**Fig. 2B**). Since Met44 and Met47 are oxidized *in vivo* by specific and highly regulated enzymes through non-diffusing oxidant production, they gained increasing attention in the last two decades and will be the topic of part III.

Amino acids other than cysteines and methionines can undergo oxidation in an irreversible manner (**Fig. 1**): in actin some **histidines** can be carbonylated (Dalle-Donne et al., 2007), some **tryptophanes** can undergo oxidation (Fedorova et al., 2010) and some **tyrosines** can be nitrated by the RNS peroxynitrite (Aslan et al., 2003) (**Fig. 2A**).

Collectively, the susceptibility of a specific residue to oxidation largely depends on actin's conformation, environment, ionic state and binding to other proteins. Enzymes can

also specifically modify selected actin residues. This explains why not all the aforementioned amino acids of actin have been found modified by redox reactions. Of note, some of the results reported in this section have been obtained by using non-physiological levels of oxidants —e.g. millimolar concentrations of H_2O_2 (Lassing et al., 2007), far more than the 100 nM putative highest physiological concentration (Sies and Jones, 2020)— or non-physiological oxidants such as tert-butyl hydroperoxide (DalleDonne et al., 1999). Therefore, it is important to question the physiological relevance of the reactivity of actin residues evidenced by these experiments. It is also interesting to note that a single amino acid (e.g. Cys374) can be the target of several redox reactions, such as oxidation by H_2O_2 , disulfide bond formation, glutathionylation, S-nitrosylation and carbonylation (**Fig. 2A**). Actin residues whose oxidation has a well understood impact on actin dynamics *in vitro* and/or *in vivo* have been highlighted in **Fig. 2B** and will be further discussed.

Origin of the oxidative species that oxidize actin in the cell

The main cellular ROS involved in the reversible oxidation of proteins, including actin, is H_2O_2 (Sies and Jones, 2020). In the early 1970s, H_2O_2 was discovered as physiologically present in cells at low concentration (Sies and Chance, 1970) and maintained typically around 1 - 10 nM (Sies and Jones, 2020). As a matter of comparison, O_2^- is present at a much lower cellular concentration, typically around 10 pM. However, these concentrations are only indicative, since cellular ROS concentrations are usually not homogenous (Sies and Jones, 2020). Because of its possible diffusion through membranes and of its relatively long half-life (around 1 ms, depending on the cellular environment (Reth, 2002)), H_2O_2 can indeed form subcellular gradients across organelle membranes and within the cytosol. In contrast, O_2^- cannot cross membranes and has a short half-life of 1 μs (Reth, 2002), which restrains its diffusion.

To date, over 40 enzymes producing H_2O_2 and/or O_2^- have been identified in humans (reviewed in (Sies and Jones, 2020)). They can be present in specific intracellular organelles (mitochondria, peroxisome, endoplasmic reticulum, endosomes), at the plasma membrane or localize to the cytoplasm. A main source of cellular H_2O_2 arises from the dismutation of O_2^- either spontaneously or catalyzed by super oxide dismutases (SODs) (**Fig. 3**). O_2^- itself is enzymatically produced by specific enzymes, notably the NADPH oxidases (NOXs) which are transmembrane proteins that convert O_2 into O_2^- , and as a by-product of the mitochondrial

electron transport chain (Sies and Jones, 2020) (**Fig. 3**). Extracellular H₂O₂ concentrations are much higher than intracellular concentrations (1-5 μM in blood plasma), and a small fraction can passively diffuse into cells through the plasma membrane or be conveyed through water channels (aquaporins) (Sies and Jones, 2020). Other ROS, such as hypochlorous acid can be enzymatically produced from H₂O₂ by specific enzymes, such as myeloperoxidases in neutrophils (**Fig. 3**).

Importantly, several diffusible ROS producing enzymes, among which NOXs, lipoxygenases, xanthine oxidase, myeloperoxidase, and NO synthase (NOS) have been shown to affect actin organisation (Wilson et al., 2016b). However, whether actin is a specific target of these enzymes is matter of debate. One can argue that actin being one of the most abundant cellular proteins, it is an inevitable target and it has even been proposed that actin could buffer ROS levels in cells (Farah et al., 2011). However, advocating for specific roles in actin oxidation, several studies have shown that ROS/RNS producing enzymes, such as components of the NOX complex as well as NOS and 5-lipoxygenase colocalise or associate with actin (Reviewed in (Acevedo and González-Billault, 2018; Terman and Kashina, 2013; Terzi and Suter, 2020; Wilson et al., 2016b)). For instance, NOX4-positive vesicles localize along stress fibers during cell adhesion, exemplifying how diffusible ROS production can be localised and specifically targeted to actin (Vukelic et al., 2018). Linking localization and function, integrin-mediated cell adhesion requires actin oxidation through NOX4-dependent H₂O₂ production (Vukelic et al., 2018). Similarly, NOX2 is required for actin organisation and remodelling in the growth cones of *Aplysia* neurons. In addition, the NOX2 regulatory cytosolic subunit p40^{phox} interacts with actin and its localisation to growth cones depends on F-actin (Munnamalai et al., 2014). Importantly, the catalytic activity of specific NOS, NOX and lipoxygenases can be regulated by actin (Acevedo and González-Billault, 2018; Kondrikov et al., 2010; Miller et al., 2001; Su et al., 2007; Tamura et al., 2000; Terzi and Suter, 2020; Usatyuk et al., 2007). Furthermore, there is a direct molecular crosstalk between Rac GTPases —which are major regulators of branched F-actin networks in cells— and NADPH oxidases (Acevedo and González-Billault, 2018; Terzi and Suter, 2020). For instance, both NOX1 and NOX2 share a common p22^{phox} subunit that forms a complex with Rac GTPases, and Rac2 is specifically required for superoxide generation in neutrophils (Glogauer et al., 2003). In addition, Rac1 translocates with NOX2 to the plasma membrane of growth cones and activates axon growth through ROS production (Munnamalai et al., 2014; Wilson et al.,

2016a). Altogether, these studies highlight a bi-directional crosstalk between actin and H₂O₂ production. They also indicate a tight link between ROS production and the actin cytoskeleton important for proper actin dynamics.

Recently, a new generation of H₂O₂ fluorescent, ultrasensitive, ratiometric, and pH independent probe (HyPer7) has been developed (Pak et al., 2020). It allows to visualize the local concentrations of this diffusible oxidant in cells and revealed that H₂O₂ produced in high quantities within mitochondria cannot efficiently diffuse into the cytosol thanks to the thioredoxin-peroxiredoxin reducing system (see below). This suggests that, contrary to previous thoughts, mitochondria are not a major source of cytosolic ROS in cells (Pak et al., 2020). Interestingly, this probe fused to the actin-binding domain Life-Act can be used to selectively measure relative H₂O₂ levels in the vicinity of the actin cytoskeleton. It was known that H₂O₂ levels are increased in migrating cells (Cameron et al., 2015) and that H₂O₂ influences actin dynamics through direct glutathionylation (Sakai et al., 2012). Thanks to the HyPer7-Life-Act probe, it is now found that steep gradients of H₂O₂ from cell protrusion (filipodia) to the cell body correlate with high stability of these protrusions (Pak et al., 2020). Thus, gradients of H₂O₂, rather than absolute levels, appear important to control cell protrusions and consequently cell migration.

The subcellular localization of enzymes producing diffusible H₂O₂ and other diffusible ROS likely explains that oxidation of cysteines can happen in specific cell area. However, as mentioned previously, H₂O₂ at physiological concentrations does not readily oxidize methionine into sulfoxide. From invertebrates to vertebrates, a conserved family of flavoenzyme oxidoreductases called MICALs oxidizes specific methionines of actin in a highly regulated manner. In 2002, the MICAL (molecule interacting with CasL) family proteins were discovered: human MICAL1 and a part of human MICAL2 were found in a screen for CasL-interacting proteins (Suzuki et al., 2002) and *Drosophila* Mical and human MICALs 1, 2, and 3 in a screen for proteins that bind to the cytoplasmic domain of the Semaphorin receptor Plexin A (Terman et al., 2002) (**Fig. 4A**).

The MICAL family proteins are composed of four conserved domains (**Fig. 4A**): a N-terminal flavoprotein monooxygenase (MO) domain essential for oxidizing actin (Hung et al., 2011; Terman et al., 2002; Vanoni, 2017; Wu et al., 2018), a calponin homology (CH) domain found in actin-binding proteins, a LIM domain (Lin-11, Isl-1 and Mec-3) and a C-terminal Plexin-interacting region (PIR)/Rab-binding domain (RBD) (referred below as the RBD

domain) (Alqassim et al., 2016; Alto and Terman, 2018; Fremont et al., 2017a; Giridharan and Caplan, 2014; Hung et al., 2011; Kim et al., 2020; Kobayashi et al., 2014; Nadella et al., 2005; Rai et al., 2016; Siebold et al., 2005; Terman et al., 2002; Vanoni, 2017; Wu et al., 2018). Of note, many notated cDNAs for MICAL2 do not include the RBD domain, but the MICAL2 genomic locus includes an RBD-coding region similar to MICAL1 and MICAL3 (Alto and Terman, 2018; Giridharan and Caplan, 2014; Hung and Terman, 2011; Terman et al., 2002) (**Fig. 4A**, dashed box).

The MICAL family proteins are ubiquitously expressed, and they can be found in the cytoplasm, associated with the plasma membrane and in the nucleus. The monooxygenase domain of each MICAL member from *Drosophila* and Human directly binds and oxidizes actin filaments (Hung et al., 2011; Wu et al., 2018). Actin is a major substrate for MICALs and its oxidation by MICALs requires FAD as a cofactor and uses NADPH and O₂ in redox reactions (Hung et al., 2011; Lundquist et al., 2014; Nadella et al., 2005; Terman et al., 2002; Vanoni, 2017; Vitali et al., 2016; Wu et al., 2018) (**Fig. 4B**). Of note, differences exist between the MICAL family members in their catalytic properties and the CH-LIM domain can be required for efficient oxidation (Vanoni, 2017; Wu et al., 2018). Remarkably, MICALs oxidize two specific actin methionines, Met44 and Met47, into methionine sulfoxides in a R-stereospecific manner (Hung et al., 2011; Wu et al., 2018).

Redox homeostasis of actin

To avoid their adverse effects and to regulate actin (and other protein) oxidation, the cellular levels of ROS, in particular H₂O₂, are tightly controlled (Sies and Jones, 2020). As shown in **Fig. 3**, several enzymes act as sinks for H₂O₂: i) Catalase dismutates H₂O₂ into H₂O and O₂; ii) glutathione peroxidase via a selenocysteine that is oxidized by H₂O₂ before being recycled by reduced glutathione (GSH); and iii) multiple peroxiredoxins (Prx) with a cysteine in their active site that is oxidized to a sulfenic acid by H₂O₂ before being recycled by cellular electron donors, usually Thioredoxins (Trx)/Thioredoxin-like (TrxL) proteins. Of note, peroxiredoxins can also act as a redox relay from H₂O₂ to oxidize proteins. Thanks to these buffering systems, the H₂O₂ concentration in the cytosol, that is relevant for actin oxidation, is maintained at 80 pM (Lim et al., 2015), whereas in the endoplasmic reticulum lumen it is

700 nM and adapted for disulfide bond formation and proper protein folding (Gao et al., 2017).

Beyond peroxiredoxin recycling, thioredoxin is considered as the main disulfide reductase of cells (Lu and Holmgren, 2014). Together with thioredoxin reductase (TrxR) and NADPH, this constitutes the thioredoxin system (**Fig.1 and Fig. 3**). Like thioredoxin, glutaredoxin (Grx) is a disulfide reductase; however, it has a broader spectrum of substrates and of mechanisms of action (Ogata et al., 2021). For instance, glutaredoxin can reverse not only disulfide bonds but also protein S-glutathionylation. Together, thioredoxins and glutaredoxins play a key role in maintaining protein redox homeostasis in the cell by reducing oxidized cysteines (**Fig. 1**). Several lines of evidence indicate that Trx and Grx play a role in regulating the redox state of actin. For instance, the thioredoxin system (Trx, TrxR and NADPH) can rapidly reduce *in vitro* the oxidized cysteines in β / γ cytosolic ADP-actin that have been treated with mild H₂O₂ concentrations (Lassing et al., 2007). However, under stronger H₂O₂ oxidative conditions, oxidized actin could not be reduced by the thioredoxin system (Lassing et al., 2007). Similarly, glutaredoxin can reduce glutathionylated cysteines in actin *in vitro* (Wang et al., 2001).

Two unrelated families of cellular enzymes, remarkably conserved from Archaea to Bacteria and Eukaryotes, are involved in the reduction of sulfoxide methionines (Achilli et al., 2015). The first enzyme (MsrA) specifically reduces S-sulfoxide methionines, whereas a second family of enzymes (MsrBs, MsrB1/2/3 in Humans and SelR in *Drosophila*) specifically reduces R-sulfoxide methionines (Achilli et al., 2015; Tarrago and Gladyshev, 2012) (**Fig. 5A**). They are essential for reverting oxidized methionines in damaged proteins upon oxidative stress, especially during aging. They all require a catalytic cysteine (or selenocysteine) in the active site that is oxidized to a sulfenic acid upon reduction of sulfoxide methionine to methionine (Achilli et al., 2015; Boschi-Muller and Branlant, 2014; Kim and Gladyshev, 2005). Directly or indirectly —via intra-molecular disulfides— thioredoxins but also thioneines and glutaredoxins reduce the sulfenic acid in the catalytic site and recycle the enzyme (Boschi-Muller and Branlant, 2014; Kim and Gladyshev, 2005) (**Fig. 5B**). As described in section III, the SelR/MsrB members play a key role in reducing actin Met44/Met47 oxidized by MICAL family enzymes *in vivo*.

II- Consequences of actin oxidation by diffusing redox species

Actin oxidation has two major effects: first, it has an impact on actin polymerization/depolymerization and on the mechanical properties of actin filaments (F-actin) and second, it modifies the interactions between actin and ABPs. There is no general rule regarding the consequences of actin oxidation, which largely depend on the residue that is modified, its position and the type of redox PTM. In this section, we will describe the consequences of both reversible and irreversible oxidation of actin by diffusing redox species, *in vitro* and *in vivo*.

***In vitro* consequences of reversible actin oxidation by diffusing redox species**

Treatment of G-actin with millimolar concentrations of H₂O₂ *in vitro* results in the oxidation of two cysteines: Cys272 and Cys374 (DalleDonne et al., 1995; Lassing et al., 2007; Milzani et al., 2000). Notably, the consequences of H₂O₂ treatment strongly depend on the nature and concentration of the divalent cations as well as the nucleotide that is bound to G-actin. Treatment of Ca²⁺-bound G-actin with H₂O₂ decreases its polymerization rate and polymerization extent (DalleDonne et al., 1995) or even leads to a total loss of ability to polymerize (Lassing et al., 2007). Remarkably, actin filaments polymerized from H₂O₂-oxidized monomers are more fragmented and fragile, compared to unoxidized filaments (DalleDonne et al., 1995). In contrast to Ca²⁺-bound G-actin, Mg²⁺-bound G-actin is resistant to similar concentrations of H₂O₂ (Fremont et al., 2017a; Guan et al., 2003; Hung et al., 2011). In addition, oxidation of F-actin by H₂O₂ in the presence of high Ca²⁺ concentrations (≈ 0.1 mM) triggers F-actin depolymerization, whereas it is not the case at low Ca²⁺ concentrations (1 μM) (Lassing et al., 2007). The marked difference between Ca²⁺- vs. Mg²⁺-bound G-actin reactivity towards H₂O₂ treatment is likely caused by a distinct conformation of G-actin affecting the exposure of specific cysteine residues (Guan et al., 2003; Lassing et al., 2007; Takamoto et al., 2007). The outcome of H₂O₂ treatment also critically depends on whether actin is bound to ADP or ATP. The same concentration of H₂O₂ (5 mM) completely abolishes the ability of ADP-bound G-actin to polymerize, but has no such effect on ATP-bound G-actin (Lassing et al., 2007).

Actin Cys374 can also be glutathionylated, thus forming glutathionyl-actin (GS-actin). Cys374 glutathionylation decreases the polymerization rate of actin due to impaired

elongation (Dalle-Donne et al., 2003; Stournaras et al., 1990; Wang et al., 2001). The effect of Cys374 glutathionylation is likely caused by a conformational change in the D-loop at the interface between actin subunits in the actin filament (Dalle-Donne et al., 2003). Strikingly, GS-actin filaments are easily disrupted under shearing stress, compared to non-glutathionylated actin filaments (Stournaras et al., 1990). The effect of Cys374 S-nitrosylation remains to be fully clarified but viscometry assays suggest that S-nitrosylated G-actin also polymerizes less efficiently than native monomers (Dalle-Donne et al., 2000).

As described in section I, Cys374 can form either intra-molecular or inter-molecular disulfide bonds upon oxidation. Inter-molecular disulfide bonds lead to the formation of actin antiparallel dimers that can be incorporated into actin filaments (Lassing et al., 2007; Steinmetz et al., 1997; Tang et al., 1999). Interestingly, this results into enhanced elasticity of F-actin networks *in vitro* (Tang et al., 1999). Altogether, several redox modifications of actin, notably Cys374, change the mechanical properties of actin filaments *in vitro*.

Redox PTMs affect the polymerization of actin but also interactions with ABPs. Both oxidation by H₂O₂ and Cys374 S-nitrosylation of G-actin impair G-actin binding to profilin *in vitro* (García-Ortiz et al., 2017; Lassing et al., 2007). F-actin polymers from oxidized monomers also display altered binding to filamin, α -actinin (DalleDonne et al., 1995) and spectrin (Shartava et al., 1995) *in vitro*, and to vinculin (Huot et al., 1997; Vukelic et al., 2018) *in vivo*. In addition, nitroxyl (HNO) induces disulfide bond formation between Cys190 of tropomyosin and Cys257 of actin in myofilaments (Gao et al., 2012), while tropomyosin binds Cys374-glutathionylated F-actin with significantly reduced cooperativity (Chen and Ogut, 2006).

***In vivo* importance of reversible actin oxidation in physiological conditions by diffusing redox species**

The following examples illustrate how actin oxidation under physiological conditions regulates important actin-based cellular processes.

Several studies demonstrate that actin oxidation is required for actin cytoskeleton remodeling and focal adhesion formation during integrin-mediated cell adhesion (Fiaschi et al., 2006; Sobierajska et al., 2014; Vukelic et al., 2018). During cell spreading, integrin engagement triggers a Rac1-dependent production of ROS as a consequence of the 5-lipoxygenase (LOX) activation (Chiarugi et al., 2003). Consequently, chemical LOX inhibition impairs spreading (Fiaschi et al., 2006). During cell spreading, ROS production induces actin

Cys374 glutathionylation, which was found essential for cell adhesion by regulating the formation of stress fibers and the disassembly of the actomyosin complex (Fiaschi et al., 2006). These results are consistent with previous findings showing that deglutathionylation of Cys374 mediates striking cytoskeleton rearrangement and a strong increase in the amounts of cellular F-actin amount in EGF-stimulated A431 cells (Wang et al., 2001). It was further shown that during integrin-mediated adhesion of smooth vascular muscle cells, intracellular H₂O₂ levels increase in a NOX4-dependent manner and are responsible for F-actin oxidation. This work also suggests that increased F-actin-vinculin interaction, required for proper cell adhesion, is mediated by Cys272 or Cys374 oxidation by NOX4-produced H₂O₂. Altogether, actin modification by distinct redox PTMs on Cys374 modulates actin interaction with ABPs and promotes cell adhesion.

Actin dynamics is also controlled by glutathionylation in neutrophils *in vivo* (Sakai et al., 2012). Upon stimulation, actin in neutrophils is reversibly glutathionylated in a NOX-dependent manner. In addition, when glutathionylation or ROS production are inhibited, cellular F-actin amounts are increased, and chemotaxis is altered. However, depletion of glutaredoxin (which is important for de-glutathionylation, in particular of actin) can correct both F-actin and chemotaxis defects observed upon ROS depletion (see also next paragraph). This and other experiments using Cys374 mutants, suggest that glutathionylation of actin on Cys374 negatively controls actin polymerization during polarization, chemotaxis, adhesion, and phagocytosis in neutrophils (Sakai et al., 2012).

As mentioned in sections I and II, actin Cys374 can also be S-nitrosylated by NO. Remarkably, β -actin interacts with endothelial nitric oxide synthase (eNOS) and this interaction increases eNOS activity and NO production both *in vitro* and *in vivo* (Kondrikov et al., 2010). Functionally, disruption of eNOS/beta-actin interaction in endothelial cells leads to impaired actin-dependent endothelial monolayer wound repair (Kondrikov et al., 2010). Actin S-nitrosylation of Cys374 by eNOS also plays a key role in the cytoskeletal rearrangements and the recruitment of signaling molecules at the immune synapse (IS) by impairing actin binding to profilin-1 (García-Ortiz et al., 2017).

Actin Redox homeostasis by diffusing redox species *in vivo*

Thioredoxin and glutaredoxin are known to revert *in vitro* actin cysteine oxidation by H₂O₂ and glutathionylation, respectively (section I). There is evidence that disulfide reduction by these two systems is relevant *in vivo*.

In mice (Fu et al., 2009) and human cells (Wang et al., 2010; Zschauer et al., 2011), actin is a target for Trx1 *in vivo*. Trx also controls the reduction of the actin homologue in *E. coli*, MreB (Arts et al., 2016). In human cells, pull-down experiments strongly suggest a direct interaction between Trx1 and actin, likely via Cys62 (Wang et al., 2010). Moreover, this interaction is decreased when cells are treated with high concentrations of H₂O₂, suggesting that Trx/actin interaction is redox dependent (Wang et al., 2010). Furthermore, Trx preferentially binds actin monomers, as shown in cells treated with cytochalasin D (Zschauer et al., 2011). In addition, Trx1 (Zschauer et al., 2011) and a splice variant of Trx Reductase 1 (Damdimopoulou et al., 2009) partially localize to actin-rich structures at the cell leading edge. Functionally, the interaction between Trx and actin has important implications. Trx1 overexpression protects cells from the deleterious effects of H₂O₂ on actin cytoskeleton (Wang et al., 2010; Zschauer et al., 2011). It is noteworthy that the consequences of H₂O₂ treatments on actin cytoskeleton differ in these two studies: treatment of human neuroblast SH-SY5Y cells with 100 μM H₂O₂ for 30 min leads to a decreased amount of F-actin (Wang et al., 2010), whereas treatment of human primary endothelial cells with 200 μM H₂O₂ for 1 h results in increased formation of stress fibers (Zschauer et al., 2011). This may be explained by differences in cell types, importantly primary vs. cancer cells. Nevertheless, both studies suggest that Trx regulates actin redox status and thereby the cellular actin cytoskeleton.

Beside a role of Trx in disulfide reduction, several reports indicate that the reduction of the mixed disulfide GS-actin can be mediated by glutaredoxin (Sakai et al., 2012), and that glutaredoxin has a major impact on the actin cytoskeleton-dependent morphology in neurons *in vivo* (Kommaddi et al., 2019). Specifically, actin glutathionylation decreases and the amount of F-actin concomitantly increases in response to EGF stimulation of A431 cells (Wang et al., 2001). Inhibition of Grx1 by Cd²⁺, a potent glutaredoxin inhibitor, impairs the de-glutathionylation of actin upon EGF treatment, suggesting a role of Grx1 in reducing GS-actin. Of note, cellular H₂O₂ levels rise following EGF stimulation, which is not consistent with a decrease in actin glutathionylation at first sight. This suggests that actin redox PTMs are not merely regulated by the global level of diffusible ROS in cells but are rather regulated by

active and local mechanisms (Wang et al., 2001). In contrast, ROS-dependent glutathionylation of proteins colocalizing with actin increases at the leading edge of the cells during migration of neutrophils stimulated by chemoattractants (Sakai et al., 2012). In addition, actin glutathionylation is required for proper chemotaxis by negatively regulating actin polymerization. Decreasing actin glutathionylation by overexpression of Grx1 increases actin polymerization, induces the formation of multiple pseudopods and impairs chemotaxis (Sakai et al., 2012). Furthermore, Grx1 knock-out in neutrophils isolated from Grx1^{-/-} mice (which are viable) also leads to impaired actin polymerization and severe defects in chemotaxis, cell adhesion and phagocytosis (Sakai et al., 2012). This example illustrates how sensitive the control of actin redox homeostasis through Grx1 is and that a proper balance of actin glutathionylation is crucial for neutrophil biology. Moreover, Grx1 overexpression, controls normal F-actin levels in a mouse model of Alzheimer's disease (APP/PS1 mice), further demonstrating a key role of actin glutathionylation *in vivo* (Kommaddi et al., 2019). STORM microscopy analysis of isolated neurons from APP/PS1 mice reveals that Grx1 overexpression restores the nano-architecture of F-actin in spines similar to WT mice. Remarkably, this is sufficient to mitigate memory loss in this model (Kommaddi et al., 2019). Collectively, these three studies show that Grx acts as a positive regulator of actin polymerization *in vivo*, and reveal its physiological importance.

***In vitro* and *in vivo* consequences of irreversible redox modifications of actin by diffusing redox species**

Thus far, we described the impact of reversible redox modifications by diffusing redox species but irreversible redox changes in actin can also occur, in particular in pathological conditions. For instance, Tyrosine nitration is irreversible and is caused by the addition of a nitro (-NO₂) group in ortho position of the aromatic cycle due to RNS (**Fig. 1**). Because of the addition of this relatively voluminous and anionic moiety, tyrosine nitration (NO₂Tyr) can trigger changes in protein conformation and have important functional consequences (Aslan, 2012). Notably, tyrosine nitration decreases the pK_a of tyrosine's hydroxyl group from 10.1 to 7.2, which has a major impact on tyrosine's electrical charge at physiological pH (Schopfer et al., 2003). Actin has several tyrosine residues at important locations —Tyr53 in the D-loop and Tyr69 in subdomain 2— involved in intermonomer interaction. Incubation with SIN-1, a peroxynitrite (ONOO⁻) generator, both decreases the

rate of G-actin polymerization and induces F-actin depolymerization *in vitro* in a concentration-dependent manner. Importantly, SIN-1 treatment increases the amount of NO₂Tyr and does not affect other redox PTMs such as dityrosine or carbonyl formation (Clements et al., 2003). Following SIN-1 treatment, actin polymerization, migration, chemotaxis and phagocytosis are inhibited in neutrophils (Clements et al., 2003). Estimations indicate that the levels of peroxynitrite used in this study would likely be encountered by neutrophils at sites of inflammation and thus actin nitration may physiologically modulate host defence against pathogens.

Tyrosine nitration of actin was also observed in several pathological situations, such as sickle cell disease (SCD) (Aslan et al., 2003). In SCD, intermittent vascular occlusion results in transient ischemia followed by inflammation and enhanced production of ROS and NO. Analysis of liver and kidney tissue from SCD mice showed that actin is the main nitrated protein, on Tyr91, Tyr98 and Tyr240. Confocal microscopy imaging of kidney tissue from mouse and human SCD reveals that actin is completely disorganized when nitrated, strongly suggesting that actin nitration impacts on actin polymerization (Aslan et al., 2003). In addition, peroxynitrite mediates TNF-induced endothelial barrier dysfunction and is associated with actin tyrosine nitration (Neumann et al., 2006). Actin tyrosine nitration has also been linked with other diseases such as chronic obstructive pulmonary disease, Chagas disease, diabetic cardiomyopathy, familial amyotrophic lateral sclerosis (Aslan, 2012) and Marfan syndrome (Jiménez-Altayó et al., 2018).

Beside tyrosine nitration, carbonylation is another irreversible redox modification and covers a wide range of oxidation reactions (**Fig. 1**). Strictly speaking, protein carbonylation is a post translational modification leading to the addition of a reactive carbonyl group (often aldehyde, ketone or lactam) to a residue side chain. Actin carbonylation is actually associated with many diseases (Castro et al., 2013). Functionally, prolonged H₂O₂ treatment induces actin carbonylation which leads to the formation of actin aggregates *in vitro* and *in vivo* in Jurkat T cells (Castro et al., 2012). These aggregates colocalize with the proteasome and their formation inhibits the proteasome activity, which greatly impacts on cell metabolism (Castro et al., 2012).

We have described in this section the impact of redox modifications on actin resulting from reactions involving diffusing redox reactive species, in particular H₂O₂. While

the enzymes producing ROS are often localized and activated in specific cell areas, the production of diffusible ROS will affect many proteins beyond actin. We will now focus on specific enzymes that directly target actin and thus control the actin cytoskeleton in a more selective manner.

III- Consequences of direct oxidation/reduction of actin Met44/47 by MICALs and SelR/MsrBs

Several reviews have focused on MICALs (Alto and Terman, 2018; Fremont et al., 2017b; Giridharan and Caplan, 2014; Ortegón Salas et al., 2020; Vanoni, 2017) and this review will thus detail recent uncovered functions of MICALs, highlight new insights on how these enzymes are regulated, and emphasize how MICALs can locally control actin dynamics through specific methionine oxidation, thus contributing to a multitude of cellular events. The *in vivo* function of the enzymes of the SelR/MsrB family that reduce MICAL-oxidized actin and thereby counteract MICALs will also be described.

MICALs control various biological functions, often linked to actin remodeling

Pioneer work first demonstrated that *Drosophila* Mical is involved in axonal repulsion *in vivo* (Terman et al., 2002). Beside its role in axon guidance, *Drosophila* Mical is involved in synapse development (Beuchle et al., 2007; Hung et al., 2013; Orr et al., 2017; Rich et al., 2021), dendrite morphology (Kirilly et al., 2009; Rui et al., 2020; Wolterhoff et al., 2020), muscle organization (Beuchle et al., 2007; Hung et al., 2013; Schnorrer et al., 2010) and mechanosensory organ (bristle) development (Hung et al., 2011; Hung et al., 2010).

MICAL1, the most studied vertebrate MICAL, is also required for several aspects of neuronal biology (Morinaka et al., 2011; Schmidt et al., 2008; Van Battum et al., 2014), but also for cell division (Bai et al., 2020; Fremont et al., 2017a; Niu et al., 2020), cell migration (Deng et al., 2016; Gu et al., 2022; McGarry et al., 2021; Zhao et al., 2019), cell viability (Loria et al., 2015; Zhou et al., 2011), apoptosis and autophagy (Xu et al., 2021a), cell shape regulation (Aggarwal et al., 2015; Giridharan et al., 2012; Tufro, 2017) and exocytosis (Lucken-Ardjomande Häsler et al., 2020; Shi et al., 2020). Moreover, recent studies pointed towards

an implication or association of MICAL1 with cancer (Deng et al., 2016; Deng et al., 2018; Grauzam et al., 2018; Gu et al., 2022; Liu et al., 2019; Loria et al., 2015; McGarry et al., 2021; Tang et al., 2021; Xu et al., 2021b; Yoon et al., 2017; Zhao et al., 2019), epilepsy (Dazzo et al., 2018; Luo et al., 2011), cardiac stress response (Konstantinidis et al., 2020) and proposed MICAL1 as a potential biomarker in pulmonary tuberculosis (Qin et al., 2016).

MICAL2 has been involved in tumor progression and cancer pathogenesis (Ashida et al., 2006; Barravecchia et al., 2019; Cai et al., 2018; Hellweg et al., 2018; Liu et al., 2019; Mariotti et al., 2016; Pu et al., 2021; Qi et al., 2021; Wang et al., 2018; Wang et al., 2021b; Zhang et al., 2022; Zhou et al., 2020). In addition, MICAL2 has been implicated in angiogenesis (Hou et al., 2015), cell viability (Ashida et al., 2006), regulation of cell shape (Giridharan et al., 2012), gene transcription (Lundquist et al., 2014), mitochondrial trafficking (Wang et al., 2021a), muscle tissues regeneration, differentiation and proliferation (Giarratana et al., 2020; Jiang et al., 2021; Tao et al., 2019) and host-virus interactions (Galloni et al., 2021).

MICAL3 has been implicated in cell migration (Bron et al., 2007), cell shape regulation (Giridharan et al., 2012), exocytosis (Grigoriev et al., 2007), neuronal biology (Hamdan et al., 2020) and breast cancer biology (Ghafouri-Fard et al., 2021; Tominaga et al., 2019). In addition, MICAL3 plays a role in cytokinesis, but this function does not involve actin remodeling (Liu et al., 2016).

MICALs oxidize specific actin methionines and trigger filament depolymerization

Different biochemical mechanisms have been proposed to explain how the oxidoreductase activity of MICALs modifies the Met44 and Met47 residues on F-actin. The first hypothesis is based on results that MICALs directly interact with F-actin, which directly activates their NADPH-dependent enzyme activity. This leads to the stereospecific oxidation of Met44 and Met47 into methionine (*R*) sulfoxides and triggers the disassembly of actin filaments (Hung et al., 2013; Hung and Terman, 2011; Lee et al., 2013; Wu et al., 2018). In a second hypothesis, each MICAL proteins reacts with water and produces ROS such as H₂O₂, as observed both *in vitro* and *in vivo* (Giridharan and Caplan, 2014; Hung et al., 2010; Morinaka et al., 2011; Nadella et al., 2005 ; Schmidt et al., 2008; Wu et al., 2018; Zhou et al., 2011). Furthermore, the binding of MICAL1 to F-actin increases the level of diffusive H₂O₂. It was thus proposed that the production of locally high levels of H₂O₂ could be the means that promote F-actin oxidation on Met44 and Met47 residues and then their depolymerization

(Hung and Terman, 2011; Vitali et al., 2016). However, the consensus tends towards the first hypothesis, since a direct contact between MICAL proteins and actin filaments seem to be mandatory for their oxidation and no effect on F-actin is observed when incubated with high levels of H₂O₂ (Fremont et al., 2017a; Hung et al., 2011; Hung et al., 2010; Wu et al., 2018), at least in absence of high Ca⁺⁺ concentration (see section II) as it is likely the case *in vivo*.

How does F-actin oxidation by MICALs trigger filament depolymerization? Remarkably, Met44 and Met47 found to be oxidized by MICALs are located within the D-loop of actin, at the contact site between two actin subunits in the filament (Dominguez and Holmes, 2011) (**Fig. 2B**). Initially, *in vitro* work using bulk assays, *Drosophila* Mical was proposed to be a direct depolymerization factor (Hung and Terman, 2011; Hung et al., 2010). Follow-up work using *in vitro* TIRF microscopy of single immobilized actin filaments led to Mical also being proposed as a direct F-actin-severing protein (Grintsevich et al., 2017; Grintsevich et al., 2016; Hung et al., 2011). Later, a study using *in vitro* microfluidics approaches on single actin filaments showed that both human MICAL1 and *Drosophila* Mical do not directly sever F-actin (Fremont et al., 2017a). Instead, it was observed that F-actin depolymerizes at increased rate, from both filament ends, when it has been oxidized by MICAL1 (Fremont et al., 2017a). The basis for these different observations can stem from different experimental conditions (e.g. interaction of the filaments with the surface, fraction of fluorescently-labelled actin, illumination conditions) and requires further investigation. At the molecular level, it was hypothesized that oxidation of Met44 and Met47 weakens the interaction between actin subunits within filaments, which fragilizes them and thus enhances their rate of disassembly (Fremont et al., 2017a; Hung et al., 2011). To explore this possibility, near-atomic resolution cryo-EM reconstruction of Mical-oxidized-F-actin combined with site-directed mutagenesis on actin has been carried out (Grintsevich et al., 2017). A 3.9 Å resolution structure of Mical-oxidized-F-actin reveals that oxidation by Mical reorients the side chain of Met44 and allows the formation of a new hydrogen bond between the oxygen on the oxidized sulfur of Met47 and the hydroxyl group of Thr351 (Met47-O-Thr351) on the adjacent subunit. This newly described intermolecular interaction causes a twist in the D-loop and together with the oxidation of Met44 is responsible for the oxidized-F-actin instability, leading to fast depolymerization of the filament. The results support the hypothesis that oxidation of both residues Met44 and Met47 residues of actin by MICAL contributes to the fast F-actin depolymerization.

Actin oxidation by MICALs modifies interactions between actin and ABPs

Recent reports demonstrate that actin oxidation by MICALs profoundly modifies interactions with ABPs, further explaining why MICALs efficiently trigger F-actin disassembly *in vivo*.

Cofilin has long been described as a central regulator of F-actin disassembly in cells, since it can fragment and induce the depolymerization of F-actin (Wioland et al., 2017; Wioland et al., 2019). Intriguingly, F-actin severing requires high levels of cofilin *in vitro*. In contrast, low doses of cofilin-1 can efficiently sever actin filaments that have been partially oxidized by *Drosophila* Mical *in vitro* (Grintsevich et al., 2016). This demonstrates a strong synergy between Mical and cofilin-1 in F-actin disassembly. This finding was recently confirmed using human MICAL1 and cofilin-1 in single filament experiments *in vitro* (Wioland et al., 2021). Mechanistically, it has been found that actin filament oxidation by MICALs favors the binding, nucleation and growth of cofilin domains on F-actin and enhances severing rates by several orders of magnitude (Grintsevich et al., 2016; Wioland et al., 2021; Wioland et al., 2017; Wioland et al., 2019). Interestingly, even inactive (phosphorylated) cofilin-1 efficiently binds and severs F-actin when oxidized by MICAL1. Moreover, oxidation of actin filaments by MICAL1 triggers their fast disassembly by cofilin-1 even when they are protected by Tropomyosin 1.8 (Wioland et al., 2021). Thus, MICALs-induced oxidation of actin filaments suppresses their physiological protection from the action of cofilin. Together, these two studies suggest that in cells, the local disassembly of F-actin is ensured by a coincidental mechanism involving cofilin and MICALs.

What is the fate of Mical-oxidized actin, once depolymerized? In cells, the pool of G-actin is mostly complexed with sequestering proteins like Profilin (Xue and Robinson, 2013), which prevent spontaneous actin nucleation and facilitate controlled assembly and elongation of F-actin by specialized ABP such as formins and Ena/VASP (Courtemanche, 2018). Interestingly, Profilin still binds Mical-oxidized actin *in vitro*, but the complexes cannot be used by actin elongation-promoting factors, thus impairing F-actin polymerization (Grintsevich et al., 2021).

Altogether, MICALs-mediated oxidation both favors ABP-dependent disassembly of F-actin and inhibits F-actin polymerization, contributing to a spatio-temporal regulation of F-actin remodeling in cells.

Activation and regulation of MICALs' enzymatic activity

Release of the auto-inhibited conformation of MICALs. The enzymatic activity of MICALs must be tightly regulated at the right time and space, since uncontrolled activation of MICALs leads to complete depolymerization of cellular F-actin (Giridharan et al., 2012; Grigoriev et al., 2011; Hung et al., 2011). MICALs are maintained in an auto-inhibited conformation, through an intramolecular interaction between the N-terminal/C-terminal domains that inhibits the enzymatic activity (Esposito et al., 2019; Fremont et al., 2017a; Giridharan et al., 2012; Schmidt et al., 2008). Consequently, binding of specific effector proteins to the C-terminal extremity of MICAL relieves the auto-inhibition and triggers the activation of MICAL's enzymatic activity. This mechanism of activation has been first demonstrated in *Drosophila* neurons, where the transmembrane Semaphorin receptor PlexinA specifically binds to the C-terminal domain of Mical (Terman et al., 2002). This plays a crucial role in response to Semaphorin signaling that activates F-actin depolymerization by Mical to promote axonal repulsion (Hung et al., 2010; Terman et al., 2002). Other studies have demonstrated that the conserved C-terminal RBD region of MICAL proteins (**Fig. 4A**) physically interacts with several Rab GTPases (Esposito et al., 2019; Fischer et al., 2005; Fremont et al., 2017a; Fukuda et al., 2008; Rai et al., 2016; Weide et al., 2003), which are key regulators of membrane trafficking in eukaryotic cells (Hutagalung and Novick, 2011). It was first believed that the C-terminal part of MICAL proteins was a coiled-coil domain, but two independent X-ray crystallography studies revealed that this domain forms a curved sheet of three helices that expose two opposite flat surfaces and that MICALs are monomeric enzymes. Two distinct Rab protein binding sites were identified with different affinities on either side of the sheet in MICAL1 and MICAL3 (Rai et al., 2016) (**Fig. 4A**). Specific Rab GTPases (e.g. Rab8) can bind to these two binding sites, while others, such as Rab35, only bind to the one with the highest affinity (Esposito et al., 2019; Fremont et al., 2017a; Rai et al., 2016), suggesting sophisticated mechanisms of MICAL1 activation. Single actin filament and purified proteins further demonstrated *in vitro* that the direct interaction of GTP-bound (active) Rab35 with the C-terminal domain of MICAL1 fully releases its auto-inhibitory state and thus induces F-actin depolymerization (Fremont et al., 2017a). Later, the characterization of the GTP-bound Rab8-MICAL1 interaction showed that this GTPase also stabilizes the active conformation of MICAL1, confirming the key role of Rab GTPases as activators of MICAL proteins (Esposito et al., 2019) (**Fig. 4C**).

Activation of MICALs by kinases. Recent findings demonstrate that the enzymatic activity of MICAL proteins can be regulated by different kinases, in addition to the regulation described above. Once activated by Semaphorin/Plexin, the MO domain of *Drosophila* Mical and vertebrate MICAL1 is phosphorylated by the non-receptor Abl tyrosine kinase (Yoon et al., 2017) (**Fig. 4A**). Importantly, Abl kinases are known to regulate F-actin remodeling downstream of different growth factors, including tumor growth factors (TGF) (Pu et al., 2021; Wang et al., 2018; Yoon et al., 2017). The direct phosphorylation of a conserved tyrosine Tyr500 residue in *Drosophila* Mical redox domain by Abl increases the enzymatic activity, thus F-actin disassembly *in vitro* (Yoon et al., 2017). *In vivo*, a role for the phosphorylation of Mical by Abl has been shown in bristle development and axon guidance in *Drosophila*, as well as in regulating breast cancer cell invasion and survival in tumor progression assays (Yoon et al., 2017). This regulatory mechanism applies to other MICAL members, since human ABL2 directly phosphorylates MICAL2 at Tyr445, Tyr463 and Tyr488 and accelerates MICAL2-mediated actin disassembly (Zhang et al., 2022) (**Fig. 4A**). Interestingly, chemical inhibition of MICAL2 inhibits proliferation, invasion, and migration of head and neck squamous cell carcinoma cells (Zhang et al., 2022). In addition to ABL family kinases, the serine/threonine kinase PAK1, after its activation by CDC42, was recently proposed to phosphorylate MICAL1 on Ser817 and Ser960, increasing F-actin disassembly (McGarry, 2021) (**Fig. 4A**). The phosphorylation of these residues not only increases MICAL1 enzymatic activity but is also proposed to relieve the auto-inhibited conformation of MICAL1, thus increasing Rab GTPases binding which could further activate MICAL1. Altogether, at least two levels of regulation, via phosphorylation and PIR/RBD binding appear necessary to properly control in space and time the activation of MICALs in cells.

Recycling of the actin oxidized by MICALs: a functional role for the reductases SelR/MsrBs

Knowing that Mical-oxidized G-actin cannot repolymerize normally (Bai et al., 2020; Grintsevich et al., 2017; Grintsevich et al., 2016; Hung et al., 2011), it is essential to recycle this oxidized actin in cells.

As described in Fig. 4B and 5B, proteins of the SelR/MsrB family can stereospecifically reduce (*R*) sulfoxide methionines into methionines. Using bulk actin-pyrene assays, purified *Drosophila* SelR and Human MsrB1/B2 were found to counteract MICALs' effects on F-actin polymerization *in vitro* (Hung et al., 2013; Lee et al., 2013; Wu et al., 2018). *In vitro*

experiments on single filaments further demonstrated that MsrB2 reduces MICAL1-oxidized actin monomers but not MICAL1-oxidized F-actin (Bai et al., 2020). Conversely, *Drosophila* Mical and Human MICAL1 can only oxidize F-actin and not actin monomers. Thus, different pools of actin are targeted by these oxidases and reductases: MICALs oxidize F-actin inducing their depolymerization, while SelR/MsrBs reduce MICAL-oxidized actin monomers, making them competent for polymerization (**Fig. 6**).

As described in more detail in the next paragraph, *Drosophila* SelR counteracts Mical in bristle development, axon guidance, muscle organization and rescues Mical-induced lethality *in vivo* (Hung et al., 2013). Human MsrB2 counteracts MICAL1 in cytokinesis (Bai et al., 2020; Fremont et al., 2017a; Niu et al., 2020). In addition, in mammals, MsrB1 antagonizes MICAL1 in regulating actin dynamics during macrophage activation (Lee et al., 2013). Importantly, the specific cellular localization of SelR/MsrBs could represent an important means for the local regulation of actin polymerization/depolymerization in cells by controlling the balance between reduced and oxidized actin at the subcellular level. Of note, SelR/MsrBs are evolutionarily conserved in Archaea, Bacteria and Eukaryotes and have many other substrates beyond Mical-oxidized actin, a fact that should be taken into consideration when interpreting the phenotypes associated with MsrB depletion.

Oxidation of actin by MICALs and reduction by SelR/MsrBs: an important enzymatic balance

As mentioned above, the balance between oxidized/reduced actin Met44/Met47 has been well characterized in several instances including in bristle development, axon guidance and muscle organization *in vivo* in *Drosophila* (Hung et al., 2013) and in cytokinesis in human cells (Bai et al., 2020; Fremont et al., 2017a; Niu et al., 2020). Below, we focus on two of these events: bristle development in *Drosophila* and cytokinesis in Human cells.

Bristle development in *Drosophila*. *Drosophila* bristles are unbranched, slightly curved, actin-rich cellular protrusions emanating from the fly body. Inactivating mutations in *Mical* or overexpression of Mical in bristle cells leads to defects in their shape, with flies exhibiting abnormal, branched bristles (**Fig. 7A**). This phenotype is dependent on Mical's enzymatic activity toward F-actin (Hung et al., 2011). Thanks to genetic screens aiming at discovering enhancers and suppressors of Mical activity, a specific transposable element mutation situated in the *SelR* gene that enhances its expression was found to strongly

suppress Mical-induced actin-dependent bristle branching (Hung et al., 2013). Using overexpression and inactivating mutations in both *Mical* and *SelR* *in vivo* as well as *in vitro* assays, it was clearly demonstrated that Mical and SelR act antagonistically in actin-dependent bristle morphology through the regulation of actin Met44 oxidation (Hung et al., 2013). Interestingly, both Mical and SelR are localized at the tip of the bristles, suggesting that the local regulation of the balance between Mical-oxidized and reduced actin is important. The localization of Mical at the tip of the bristles is actually mediated by the actin-based motor Myosin15, which immunoprecipitates with Mical (Rich et al., 2021). These experiments highlighted for the first time the role of a concerted control of oxidation and reduction of methionine sulfoxides for actin-based functions *in vivo*.

Cytokinesis in Human cells. Cytokinesis consists in the physical separation of the daughter cells following mitosis. After furrow ingression, the two newly formed cells are connected by an intercellular bridge, which is eventually cut (abscission) (Fremont and Echard, 2018; Mierzwa and Gerlich, 2014). During this process, filaments made of ESCRT-III polymers are recruited to the abscission site and constrict the plasma membrane up to the point of scission (Addi et al., 2018). Prior to abscission, F-actin is progressively removed from the intercellular bridge, and it was found that F-actin accumulation acts as a physical barrier that inhibits the assembly of the ESCRT machinery at the abscission site (Fremont et al., 2017a). MICAL1 plays a critical role in abscission by controlling actin depolymerization in late cytokinetic steps (Fremont et al., 2017a) (**Fig. 7B**). Indeed, in the absence of MICAL1, F-actin accumulates in a redox-dependent manner in the intercellular bridge, leading to an abscission delay. Mechanistically, the Rab GTPase Rab35 recruits and activates MICAL1, which directly depolymerizes F-actin in the intercellular bridge, a crucial step for proper ESCRT-III recruitment and successful abscission (Fremont et al., 2017a; Iannantuono and Emery, 2021; Klinkert and Echard, 2016). While it is not known how Rab35 is recruited and activated at the intercellular bridge, a recent report showed that, independently from Rab11, Rab11FIP1 contributes to maintain high levels of Rab35 and MICAL1 at the intercellular bridge after their arrival, and is thus important for promoting actin depolymerization and abscission (Iannantuono and Emery, 2021). In addition, MICAL1 binding to myosin Va at the midbody controls the localization of cargo-containing vesicles which also contribute to abscission (Fremont and Echard, 2018; Niu et al., 2020).

Conversely, depletion of the methionine sulfoxide reductase MsrB2 accelerates abscission by decreasing F-actin levels in the intercellular bridge, which favors the localization of ESCRT-III proteins at the abscission site (Bai et al., 2020). This was surprising, since MsrB2 was initially described as a mitochondrial protein, but a cytosolic pool of MsrB2 exists as well and localizes at the intercellular bridge (Bai et al., 2020). Altogether, a balance between actin oxidation by MICAL1 and reduction by MsrB2 is thus essential for the terminal step of cytokinesis: MICAL1 and MsrB2 act as a positive or negative regulator of abscission, through depolymerization and polymerization of actin, respectively (**Fig. 7B**). These functions are evolutionarily conserved since Mical and SelR also control cytokinesis in *Drosophila* cells (Bai et al., 2020; Fremont et al., 2017a).

Interestingly, there are circumstances where abscission is actively delayed, for instance when the AuroraB-dependent abscission checkpoint is activated by the abnormal presence of lagging chromatin within the intercellular bridge (Petsalaki and Zachos, 2021). Checkpoint activation gives the cell time to resolve the abnormal presence of DNA and prevents DNA breakage and/or the formation of binucleated cells by stabilizing the intercellular bridge through F-actin accumulation (Petsalaki and Zachos, 2021). By promoting actin polymerization in the intercellular bridge, MsrB2 prevents its instability specifically in the presence of lagging chromatin, and thus constitutes a component of the abscission checkpoint (Bai et al., 2020) (**Fig. 7C**). Functionally, reduction of MICAL1-oxidized actin by MsrB2 plays an important role to prevent the formation of binucleated, tetraploid cells that can often be the starting point in tumor formation (Fujiwara et al., 2005).

Conclusion and perspectives

Direct oxidation and reduction of actin control multiple cellular events relying on local and timely remodeling of the actin cytoskeleton. Reversible oxidation of both cysteines (notably Cys374) and methionines (Met44/47) appear to play a major regulatory role. Quantitatively however, little is known on the fraction of each redox-susceptible actin residue that is oxidized *in vitro* or *in vivo*. The total number (but not the position) of reduced cysteines can be assayed with thiol-reacting agents such as DTNB (5,5'-dithiobis(2-nitrobenzoic acid)) or AMS (maleimid 4-acetamido-4'-maleimidylstilbene-2,2'-disulfonic acid)

and meylimid derivatives, whereas oxidized cysteines will not react (e.g. (DalleDonne et al., 1995; Hara et al., 2015; Lassing et al., 2007; Wang et al., 2010)). Determination of the reduced cysteines can then be investigated by chemical digestion, mutagenesis or by mass spectrometry (MS). Similarly, methionine oxidation of actin can be identified by MS (increase of 16 Da for sulfoxide methionines) (reviewed in (Ghesquière and Gevaert, 2014)). However, MALDI ionization creates a highly oxidative environment that can oxidize methionines during measurements, making it hard to quantitatively assay the amount of actin oxidized in samples (Ghesquière and Gevaert, 2014). Only state-of-the-art approaches (e.g. using reagents with heavy oxygen (O^{18}) that react with reduced methionines before MS analysis) can quantitatively determine the amount of oxidized methionines *in vivo*. Recent data revealed that 13-20% of Met190 in actin is oxidized, but tryptic peptides with two methionines (such as M44, M47) were not analyzed (Bettinger et al., 2020). Thus, future studies will clarify the amount of oxidation of each actin residue, especially Cys374 and Met44/47 *in vivo*.

It is noteworthy that demonstrating a specific role of an actin residue can be tricky *in vivo*. Indeed, some amino acid, such as Cys374, are targeted by multiple distinct redox modifications, and point mutations cannot address which exact modification is relevant (Sakai et al., 2012). Nevertheless, when possible, comparing cells depleted of enzymes responsible for the redox modification and cells expressing mutated actin with residues that cannot be oxidized can help to ascribe a specific redox modification of actin to a cellular process. This strategy has been elegantly used to help demonstrate that Met44 sulfoxidation by *Drosophila* Mical is involved in bristle morphogenesis and neuronal synaptic function *in vivo*, by looking at the effects that specific oxidation blocking actin mutants (such as M44L actins) have on Mical and SelR's effects *in vivo* (Grintsevich et al., 2016; Hung et al., 2011; Hung et al., 2013; Orr et al., 2017).

However, Met44/Met47 sulfoxidation by MICALs is quite a unique case, since specific enzymes (MICALs) directly control this redox PTM, while reductases of the SelR/MsrB family recycle specific forms of actin (oxidized actin), among other substrates. While actin is believed to be the main substrate for MICAL, the situation is actually more complex, since additional substrates have been discovered. For instance, after Sema3A stimulation, MICAL1 generates H_2O_2 that oxidizes CRMP2 at Cys504, resulting in growth cone collapse (Morinaka et al., 2011). MICAL1 has also been shown to control the redox status of the

Ca²⁺/calmodulin-dependent protein kinase II (CaMKII), by specifically oxidizing the Met308 residue, to regulate physiological and pathological cardiac stress responses (Konstantinidis et al., 2020). Interestingly, it was recently discovered that MICAL2, which was previously believed to modify actin in the nucleus (Lundquist et al., 2014), directly oxidizes into sulfoxide methionine the Met293 of Arp3B—a component of the Arp2/3 complex in the cytoplasm—to regulate the dynamics of branched actin networks (Galloni et al., 2021). This finding was particularly relevant for vaccinia virus motility within infected cells. Collectively, these studies indicate that MICAL-dependent oxidation regulates additional targets, beyond actin.

As mentioned in sections II and III, several diseases have been associated to redox PTMs of several actin residues, notably in sickle cell disease, Alzheimer's disease, and cancers (see also (Cuello et al., 2018; Terman and Kashina, 2013; Xu et al., 2017)). Interestingly, recent evidence shows that point mutations in MICAL1 are responsible for autosomal-dominant lateral temporal epilepsy, likely through increased actin oxidation. Of note, one of the mutations modifies the C-terminal domain and could explain the enhanced MICAL1 activity (Dazzo et al., 2018; Luo et al., 2011). Consistent with a key role of MICAL1 in neuronal actin remodeling, mutations in the gene encoding Reelin cause the same disease (Dazzo et al., 2015), and Reelin signaling regulates cofilin activity (Frotscher et al., 2017). Conversely, methionine sulfoxide reduction by MsrB3 is essential for the integrity of actin-rich stereocilia in hair cells and mutations in the gene encoding this enzyme result in hearing loss (Kwon et al., 2014).

In many instances, we mentioned that dynamic redox modifications of actin are important, and this is likely achieved by a locally-controlled balance between oxidation and reduction. Strikingly, the subcellular localization of the reducing system and their relationship with actin are less studied (Bai et al., 2020; Damdimopoulou et al., 2009; Rich et al., 2021; Zschauer et al., 2011). In addition, colocalization of reducing systems with actin does not prove that they are active. Thus, targeting biosensors of Trx and Grx activity (Gutscher et al., 2008; Pang et al., 2022) to F-actin through Life-Act fusion, would give invaluable information. As described in section II, this strategy has been very successful to reveal at the subcellular scale H₂O₂ gradients close to F-actin. The field of redox actin PTM is also lacking tools to visualize where and when specific redox modifications occur. For instance, alike phosphorylation, antibodies working in immunofluorescence and specific for

a given redox modification (e.g. actin Met44 sulfoxide) would be extremely useful. One can also imagine the development of genetically encoded redox specific antibodies for actin fused to GFP to determine the dynamics of these modifications in living cells or organisms (Nizak et al., 2003).

Finally, direct redox actin modifications described in this review and their consequences on actin dynamics or ABP binding are just the tip of the iceberg. Indeed, an increasing number of ABPs are themselves the target of redox modifications, which control the actin cytoskeleton. For instance, Cys139/147 oxidation of cofilin by H_2O_2 reduces actin binding and severing, and thereby regulates mesenchymal cell migration (Cameron et al., 2015). In addition, the reversible oxidation of Cys101 of the tumor marker L-Plastin through a balance of ROS and Trx1 modulates its actin bundling activity and thus control cell migration (Balta et al., 2019). Adding another layer of complexity, oxidative stress also modulates the expression of numerous genes encoding ABPs (Balta et al., 2020). We are thus at the beginning of understanding, at the mechanistic level, how oxidation and reduction are used to regulate the actin cytoskeleton in space and time.

Acknowledgments

The authors thank Drs. Miria Ricchetti, Neetu Gupta-Rossi (Institut Pasteur) and Guillaume Romet-Lemonne (Institut Jacques Monod) for critical reading of this manuscript. We thank Olena Pylypenko (Institut Curie) for her help in preparing Fig. 2B. Several illustrations were created with BioRender.com. Oxidation work in the Echard lab has been funded by the Institut Pasteur, the CNRS, ANR RedoxActin, the Fondation pour la Recherche Médicale: FRM EQU202103012627 (to AE), ANRS-21020 AP2020-2 (to SF) and SIDACTION 2021-1-FJC-13007 (to TS). We acknowledge Ecole Doctorale Frontières de l'Innovation en Recherche et Education - Programme Bettencourt" to TS.

Declarations of interest: none

References

- Acevedo, A., González-Billault, C., 2018. Crosstalk between Rac1-mediated actin regulation and ROS production. *Free radical biology & medicine* 116, 101-113.
- Achilli, C., Ciana, A., Minetti, G., 2015. The discovery of methionine sulfoxide reductase enzymes: An historical account and future perspectives. *BioFactors* 41, 135-152.
- Addi, C., Bai, J., Echard, A., 2018. Actin, microtubule, septin and ESCRT filament remodeling during late steps of cytokinesis. *Current opinion in cell biology* 50, 27-34.
- Aggarwal, P.K., Veron, D., Thomas, D.B., Siegel, D., Moeckel, G., Kashgarian, M., Tufro, A., 2015. Semaphorin3a promotes advanced diabetic nephropathy. *Diabetes* 64, 1743-1759.
- Alqassim, S.S., Urquiza, M., Borgia, E., Nagib, M., Amzel, L.M., Bianchet, M.A., 2016. Modulation of MICAL Monooxygenase Activity by its Calponin Homology Domain: Structural and Mechanistic Insights. *Scientific reports* 6, 22176.
- Alto, L.T., Terman, J.R., 2018. MICALs. *Current biology : CB* 28, R538-R541.
- Arts, I.S., Vertommen, D., Baldin, F., Laloux, G., Collet, J.F., 2016. Comprehensively Characterizing the Thioredoxin Interactome In Vivo Highlights the Central Role Played by This Ubiquitous Oxidoreductase in Redox Control. *Molecular & cellular proteomics : MCP* 15, 2125-2140.
- Ashida, S., Furihata, M., Katagiri, T., Tamura, K., Anazawa, Y., Yoshioka, H., Miki, T., Fujioka, T., Shuin, T., Nakamura, Y., Nakagawa, H., 2006. Expression of novel molecules, MICAL2-PV (MICAL2 prostate cancer variants), increases with high Gleason score and prostate cancer progression. *Clin Cancer Res* 12, 2767-2773.
- Aslan, M., 2012. Functional consequences of actin nitration: in vitro and in disease states. *Amino Acids* 42, 65-74.
- Aslan, M., Ryan, T.M., Townes, T.M., Coward, L., Kirk, M.C., Barnes, S., Alexander, C.B., Rosenfeld, S.S., Freeman, B.A., 2003. Nitric oxide-dependent generation of reactive species in sickle cell disease. Actin tyrosine induces defective cytoskeletal polymerization. *The Journal of biological chemistry* 278, 4194-4204.
- Bai, J., Wioland, H., Advedissian, T., Cuvelier, F., Romet-Lemonne, G., Echard, A., 2020. Actin reduction by MsrB2 is a key component of the cytokinetic abscission checkpoint and prevents tetraploidy. *Proceedings of the National Academy of Sciences of the United States of America* 117, 4169-4179.
- Balta, E., Hardt, R., Liang, J., Kirchgessner, H., Orlik, C., Jahraus, B., Hillmer, S., Meuer, S., Hübner, K., Wabnitz, G.H., Samstag, Y., 2019. Spatial oxidation of L-plastin downmodulates actin-based functions of tumor cells. *Nat Commun* 10, 4073.
- Balta, E., Kramer, J., Samstag, Y., 2020. Redox Regulation of the Actin Cytoskeleton in Cell Migration and Adhesion: On the Way to a Spatiotemporal View. *Front Cell Dev Biol* 8, 618261.
- Barravecchia, I., Mariotti, S., Pucci, A., Scabba, F., De Cesari, C., Bicciato, S., Tagliafico, E., Tenedini, E., Vindigni, C., Cecchini, M., Berti, G., Vitiello, M., Poliseno, L., Mazzanti, C.M., Angeloni, D., 2019. MICAL2 is expressed in cancer associated neo-angiogenic capillary endothelia and it is required for endothelial cell viability, motility and VEGF response. *Biochim Biophys Acta Mol Basis Dis* 1865, 2111-2124.
- Bettinger, J.Q., Welle, K.A., Hryhorenko, J.R., Ghaemmaghami, S., 2020. Quantitative Analysis of in Vivo Methionine Oxidation of the Human Proteome. *Journal of proteome research* 19, 624-633.

Beuchle, D., Schwarz, H., Langegger, M., Koch, I., Aberle, H., 2007. *Drosophila* MICAL regulates myofilament organization and synaptic structure. *Mech Dev* 124, 390-406.

Boschi-Muller, S., Branlant, G., 2014. Methionine sulfoxide reductase: chemistry, substrate binding, recycling process and oxidase activity. *Bioorg Chem* 57, 222-230.

Bron, R., Vermeren, M., Kokot, N., Andrews, W., Little, G.E., Mitchell, K.J., Cohen, J., 2007. Boundary cap cells constrain spinal motor neuron somal migration at motor exit points by a semaphorin-plexin mechanism. *Neural Dev* 2, 21.

Cai, Y., Lu, J., Tang, F., 2018. Overexpression of MICAL2, a novel tumor-promoting factor, accelerates tumor progression through regulating cell proliferation and EMT. *J Cancer* 9, 521-527.

Cameron, J.M., Gabrielsen, M., Chim, Y.H., Munro, J., McGhee, E.J., Sumpton, D., Eaton, P., Anderson, K.I., Yin, H., Olson, M.F., 2015. Polarized cell motility induces hydrogen peroxide to inhibit cofilin via cysteine oxidation. *Current biology : CB* 25, 1520-1525.

Castro, J.P., Jung, T., Grune, T., Almeida, H., 2013. Actin carbonylation: from cell dysfunction to organism disorder. *J Proteomics* 92, 171-180.

Castro, J.P., Ott, C., Jung, T., Grune, T., Almeida, H., 2012. Carbonylation of the cytoskeletal protein actin leads to aggregate formation. *Free radical biology & medicine* 53, 916-925.

Chen, F.C., Ogut, O., 2006. Decline of contractility during ischemia-reperfusion injury: actin glutathionylation and its effect on allosteric interaction with tropomyosin. *Am J Physiol Cell Physiol* 290, C719-727.

Chiarugi, P., Pani, G., Giannoni, E., Taddei, L., Colavitti, R., Raugei, G., Symons, M., Borrello, S., Galeotti, T., Ramponi, G., 2003. Reactive oxygen species as essential mediators of cell adhesion: the oxidative inhibition of a FAK tyrosine phosphatase is required for cell adhesion. *The Journal of cell biology* 161, 933-944.

Clements, M.K., Siemsen, D.W., Swain, S.D., Hanson, A.J., Nelson-Overton, L.K., Rohn, T.T., Quinn, M.T., 2003. Inhibition of actin polymerization by peroxynitrite modulates neutrophil functional responses. *J Leukoc Biol* 73, 344-355.

Cortese-Krott, M.M., Koning, A., Kuhnle, G.G.C., Nagy, P., Bianco, C.L., Pasch, A., Wink, D.A., Fukuto, J.M., Jackson, A.A., van Goor, H., Olson, K.R., Feelisch, M., 2017. The Reactive Species Interactome: Evolutionary Emergence, Biological Significance, and Opportunities for Redox Metabolomics and Personalized Medicine. *Antioxid Redox Signal* 27, 684-712.

Courtemanche, N., 2018. Mechanisms of formin-mediated actin assembly and dynamics. *Biophys Rev* 10, 1553-1569.

Cuello, F., Wittig, I., Lorenz, K., Eaton, P., 2018. Oxidation of cardiac myofilament proteins: Priming for dysfunction? *Mol Aspects Med* 63, 47-58.

Dalle-Donne, I., Carini, M., Vistoli, G., Gamberoni, L., Giustarini, D., Colombo, R., Maffei Facino, R., Rossi, R., Milzani, A., Aldini, G., 2007. Actin Cys374 as a nucleophilic target of alpha,beta-unsaturated aldehydes. *Free radical biology & medicine* 42, 583-598.

Dalle-Donne, I., Giustarini, D., Rossi, R., Colombo, R., Milzani, A., 2003. Reversible S-glutathionylation of Cys 374 regulates actin filament formation by inducing structural changes in the actin molecule. *Free radical biology & medicine* 34, 23-32.

Dalle-Donne, I., Milzani, A., Giustarini, D., Di Simplicio, P., Colombo, R., Rossi, R., 2000. S-NO-actin: S-nitrosylation kinetics and the effect on isolated vascular smooth muscle. *J Muscle Res Cell Motil* 21, 171-181.

Dalle-Donne, I., Rossi, R., Giustarini, D., Gagliano, N., Lusini, L., Milzani, A., Di Simplicio, P., Colombo, R., 2001. Actin carbonylation: from a simple marker of protein oxidation to

relevant signs of severe functional impairment. *Free radical biology & medicine* 31, 1075-1083.

DalleDonne, I., Milzani, A., Colombo, R., 1995. H₂O₂-treated actin: assembly and polymer interactions with cross-linking proteins. *Biophys J* 69, 2710-2719.

DalleDonne, I., Milzani, A., Colombo, R., 1999. The tert-butyl hydroperoxide-induced oxidation of actin Cys-374 is coupled with structural changes in distant regions of the protein. *Biochemistry* 38, 12471-12480.

Damdimopoulou, P.E., Miranda-Vizuete, A., Arnér, E.S., Gustafsson, J.A., Damdimopoulos, A.E., 2009. The human thioredoxin reductase-1 splice variant TXNRD1_v3 is an atypical inducer of cytoplasmic filaments and cell membrane filopodia. *Biochimica et biophysica acta* 1793, 1588-1596.

Dazzo, E., Fanciulli, M., Seriola, E., Minervini, G., Pulitano, P., Binelli, S., Di Bonaventura, C., Luisi, C., Pasini, E., Striano, S., Striano, P., Coppola, G., Chiavegato, A., Radovic, S., Spadotto, A., Uzzau, S., La Neve, A., Giallonardo, A.T., Mecarelli, O., Tosatto, S.C., Ottman, R., Michelucci, R., Nobile, C., 2015. Heterozygous reelin mutations cause autosomal-dominant lateral temporal epilepsy. *Am J Hum Genet* 96, 992-1000.

Dazzo, E., Rehberg, K., Michelucci, R., Passarelli, D., Boniver, C., Vianello Dri, V., Striano, P., Striano, S., Pasterkamp, R.J., Nobile, C., 2018. Mutations in MICAL1 cause autosomal-dominant lateral temporal epilepsy. *Ann Neurol* 83, 483-493.

Deng, W., Wang, Y., Gu, L., Duan, B., Cui, J., Zhang, Y., Chen, Y., Sun, S., Dong, J., Du, J., 2016. MICAL1 controls cell invasive phenotype via regulating oxidative stress in breast cancer cells. *BMC cancer* 16, 489.

Deng, W., Wang, Y., Zhao, S., Zhang, Y., Chen, Y., Zhao, X., Liu, L., Sun, S., Zhang, L., Ye, B., Du, J., 2018. MICAL1 facilitates breast cancer cell proliferation via ROS-sensitive ERK/cyclin D pathway. *J Cell Mol Med* 22, 3108-3118.

Dominguez, R., Holmes, K.C., 2011. Actin structure and function. *Annu Rev Biophys* 40, 169-186.

Esposito, A., Ventura, V., Petoukhov, M.V., Rai, A., Svergun, D.I., Vanoni, M.A., 2019. Human MICAL1: Activation by the small GTPase Rab8 and small-angle X-ray scattering studies on the oligomerization state of MICAL1 and its complex with Rab8. *Protein Sci* 28, 150-166.

Farah, M.E., Sirotkin, V., Haarer, B., Kakhniashvili, D., Amberg, D.C., 2011. Diverse protective roles of the actin cytoskeleton during oxidative stress. *Cytoskeleton* 68, 340-354.

Fedorova, M., Todorovsky, T., Kuleva, N., Hoffmann, R., 2010. Quantitative evaluation of tryptophan oxidation in actin and troponin I from skeletal muscles using a rat model of acute oxidative stress. *Proteomics* 10, 2692-2700.

Fiaschi, T., Cozzi, G., Raugei, G., Formigli, L., Ramponi, G., Chiarugi, P., 2006. Redox regulation of beta-actin during integrin-mediated cell adhesion. *The Journal of biological chemistry* 281, 22983-22991.

Fischer, J., Weide, T., Barnekow, A., 2005. The MICAL proteins and rab1: a possible link to the cytoskeleton? *Biochemical and biophysical research communications* 328, 415-423.

Fremont, S., Echard, A., 2018. Membrane Traffic in the Late Steps of Cytokinesis. *Current biology* : CB 28, R458-R470.

Fremont, S., Hammich, H., Bai, J., Wioland, H., Klinkert, K., Rocancourt, M., Kikuti, C., Stroebel, D., Romet-Lemonne, G., Pylypenko, O., Houdusse, A., Echard, A., 2017a. Oxidation of F-actin controls the terminal steps of cytokinesis. *Nat Commun* 8, 14528.

Fremont, S., Romet-Lemonne, G., Houdusse, A., Echard, A., 2017b. Emerging roles of MICAL family proteins - from actin oxidation to membrane trafficking during cytokinesis. *J Cell Sci* 130, 1509-1517.

Frotscher, M., Zhao, S., Wang, S., Chai, X., 2017. Reelin Signaling Inactivates Cofilin to Stabilize the Cytoskeleton of Migrating Cortical Neurons. *Front Cell Neurosci* 11, 148.

Fu, C., Wu, C., Liu, T., Ago, T., Zhai, P., Sadoshima, J., Li, H., 2009. Elucidation of thioredoxin target protein networks in mouse. *Molecular & cellular proteomics : MCP* 8, 1674-1687.

Fujiwara, T., Bandi, M., Nitta, M., Ivanova, E.V., Bronson, R.T., Pellman, D., 2005. Cytokinesis failure generating tetraploids promotes tumorigenesis in p53-null cells. *Nature* 437, 1043-1047.

Fukuda, M., Kanno, E., Ishibashi, K., Itoh, T., 2008. Large scale screening for novel rab effectors reveals unexpected broad Rab binding specificity. *Molecular & cellular proteomics : MCP* 7, 1031-1042.

Galloni, C., Carra, D., Abella, J.V.G., Kjær, S., Singaravelu, P., Barry, D.J., Kogata, N., Guérin, C., Blanchoin, L., Way, M., 2021. MICAL2 enhances branched actin network disassembly by oxidizing Arp3B-containing Arp2/3 complexes. *The Journal of cell biology* 220, e202102043.

Gao, C., Tian, Y., Zhang, R., Jing, J., Zhang, X., 2017. Endoplasmic Reticulum-Directed Ratiometric Fluorescent Probe for Quantitive Detection of Basal H(2)O(2). *Anal Chem* 89, 12945-12950.

Gao, W.D., Murray, C.I., Tian, Y., Zhong, X., DuMond, J.F., Shen, X., Stanley, B.A., Foster, D.B., Wink, D.A., King, S.B., Van Eyk, J.E., Paolocci, N., 2012. Nitroxyl-mediated disulfide bond formation between cardiac myofilament cysteines enhances contractile function. *Circ Res* 111, 1002-1011.

García-Ortiz, A., Martín-Cofreces, N.B., Ibiza, S., Ortega, Á., Izquierdo-Álvarez, A., Trullo, A., Victor, V.M., Calvo, E., Sot, B., Martínez-Ruiz, A., Vázquez, J., Sánchez-Madrid, F., Serrador, J.M., 2017. eNOS S-nitrosylates β -actin on Cys374 and regulates PKC- θ at the immune synapse by impairing actin binding to profilin-1. *PLoS biology* 15, e2000653.

Gautreau, A.M., Fregoso, F.E., Simanov, G., Dominguez, R., 2022. Nucleation, stabilization, and disassembly of branched actin networks. *Trends in cell biology* 32, 421-432.

Ghafouri-Fard, S., Asadi, M., Sohrabi, B., Arsang-Jang, S., Mehravaran, E., Taheri, M., Samsami, M., 2021. Down-regulation of a panel of immune-related lncRNAs in breast cancer. *Pathol Res Pract* 224, 153534.

Ghesquière, B., Gevaert, K., 2014. Proteomics methods to study methionine oxidation. *Mass Spectrom Rev* 33, 147-156.

Giarratana, N., Conti, F., La Rovere, R., Gijsbers, R., Carai, P., Duellen, R., Vervliet, T., Bultynck, G., Ronzoni, F., Piciotti, R., Costamagna, D., Fulle, S., Barravecchia, I., Angeloni, D., Torrente, Y., Sampaolesi, M., 2020. MICAL2 is essential for myogenic lineage commitment. *Cell Death Dis* 11, 654.

Giridharan, S.S., Caplan, S., 2014. MICAL-family proteins: Complex regulators of the actin cytoskeleton. *Antioxid Redox Signal* 20, 2059-2073.

Giridharan, S.S., Rohn, J.L., Naslavsky, N., Caplan, S., 2012. Differential regulation of actin microfilaments by human MICAL proteins. *J Cell Sci* 125, 614-624.

Glogauer, M., Marchal, C.C., Zhu, F., Worku, A., Clausen, B.E., Foerster, I., Marks, P., Downey, G.P., Dinauer, M., Kwiatkowski, D.J., 2003. Rac1 deletion in mouse neutrophils has selective effects on neutrophil functions. *J Immunol* 170, 5652-5657.

Grauzam, S., Brock, A.M., Holmes, C.O., Tiedeken, J.A., Boniface, S.G., Pierson, B.N., Patterson, D.G., Coaxum, S.D., Neskey, D.M., Rosenzweig, S.A., 2018. NEDD9 stimulated

MMP9 secretion is required for invadopodia formation in oral squamous cell carcinoma. *Oncotarget* 9, 25503-25516.

Grigoriev, I., Splinter, D., Keijzer, N., Wulf, P.S., Demmers, J., Ohtsuka, T., Modesti, M., Maly, I.V., Grosveld, F., Hoogenraad, C.C., Akhmanova, A., 2007. Rab6 regulates transport and targeting of exocytotic carriers. *Developmental cell* 13, 305-314.

Grigoriev, I., Yu, K.L., Martinez-Sanchez, E., Serra-Marques, A., Smal, I., Meijering, E., Demmers, J., Peranen, J., Pasterkamp, R.J., van der Sluijs, P., Hoogenraad, C.C., Akhmanova, A., 2011. Rab6, Rab8, and MICAL3 cooperate in controlling docking and fusion of exocytotic carriers. *Current biology : CB* 21, 967-974.

Grintsevich, E.E., Ahmed, G., Ginosyan, A.A., Wu, H., Rich, S.K., Reisler, E., Terman, J.R., 2021. Profilin and Mical combine to impair F-actin assembly and promote disassembly and remodeling. *Nat Commun* 12, 5542.

Grintsevich, E.E., Ge, P., Sawaya, M.R., Yesilyurt, H.G., Terman, J.R., Zhou, Z.H., Reisler, E., 2017. Catastrophic disassembly of actin filaments via Mical-mediated oxidation. *Nat Commun* 8, 2183.

Grintsevich, E.E., Yesilyurt, H.G., Rich, S.K., Hung, R.-J., Terman, J.R., Reisler, E., 2016. F-actin dismantling through a redox-driven synergy between Mical and cofilin. *Nature cell biology* 18, 876-885.

Gu, H., Li, Y., Cui, X., Cao, H., Hou, Z., Ti, Y., Liu, D., Gao, J., Wang, Y., Wen, P., 2022. MICAL1 inhibits colorectal cancer cell migration and proliferation by regulating the EGR1/ β -catenin signaling pathway. *Biochem Pharmacol* 195, 114870.

Guan, J.Q., Almo, S.C., Reisler, E., Chance, M.R., 2003. Structural reorganization of proteins revealed by radiolysis and mass spectrometry: G-actin solution structure is divalent cation dependent. *Biochemistry* 42, 11992-12000.

Gutscher, M., Pauleau, A.L., Marty, L., Brach, T., Wabnitz, G.H., Samstag, Y., Meyer, A.J., Dick, T.P., 2008. Real-time imaging of the intracellular glutathione redox potential. *Nat Methods* 5, 553-559.

Hamdan, H., Lim, B.C., Torii, T., Joshi, A., Konning, M., Smith, C., Palmer, D.J., Ng, P., Leterrier, C., Osés-Prieto, J.A., Burlingame, A.L., Rasband, M.N., 2020. Mapping axon initial segment structure and function by multiplexed proximity biotinylation. *Nat Commun* 11, 100.

Hara, S., Tatenaka, Y., Ohuchi, Y., Hisabori, T., 2015. Direct determination of the redox status of cysteine residues in proteins in vivo. *Biochemical and biophysical research communications* 456, 339-343.

Hellweg, R., Mooneyham, A., Chang, Z., Shetty, M., Emmings, E., Iizuka, Y., Clark, C., Starr, T., Abrahante, J.H., Schütz, F., Konecny, G., Argenta, P., Bazzaro, M., 2018. RNA Sequencing of Carboplatin- and Paclitaxel-Resistant Endometrial Cancer Cells Reveals New Stratification Markers and Molecular Targets for Cancer Treatment. *Horm Cancer* 9, 326-337.

Hou, S.T., Nilchi, L., Li, X., Gangaraju, S., Jiang, S.X., Aylsworth, A., Monette, R., Slinn, J., 2015. Semaphorin3A elevates vascular permeability and contributes to cerebral ischemia-induced brain damage. *Scientific reports* 5, 7890.

Hung, R.J., Pak, C.W., Terman, J.R., 2011. Direct redox regulation of F-actin assembly and disassembly by Mical. *Science* 334, 1710-1713.

Hung, R.J., Spaeth, C.S., Yesilyurt, H.G., Terman, J.R., 2013. SelR reverses Mical-mediated oxidation of actin to regulate F-actin dynamics. *Nature cell biology* 15, 1445-1454.

Hung, R.J., Terman, J.R., 2011. Extracellular inhibitors, repellents, and semaphorin/plexin/MICAL-mediated actin filament disassembly. *Cytoskeleton* 68, 415-433.

Hung, R.J., Yazdani, U., Yoon, J., Wu, H., Yang, T., Gupta, N., Huang, Z., van Berkel, W.J., Terman, J.R., 2010. Mical links semaphorins to F-actin disassembly. *Nature* 463, 823-827.

Huot, J., Houle, F., Marceau, F., Landry, J., 1997. Oxidative stress-induced actin reorganization mediated by the p38 mitogen-activated protein kinase/heat shock protein 27 pathway in vascular endothelial cells. *Circ Res* 80, 383-392.

Hutagalung, A.H., Novick, P.J., 2011. Role of Rab GTPases in membrane traffic and cell physiology. *Physiol Rev* 91, 119-149.

Iannantuono, N.V.G., Emery, G., 2021. Rab11FIP1 maintains Rab35 at the intercellular bridge to promote actin removal and abscission. *J Cell Sci* 134.

Ishiwata, S., 1976. Freezing of actin. Reversible oxidation of a sulfhydryl group and structural change. *Journal of biochemistry* 80, 595-609.

Jiang, F., Cao, J., Kong, R., Fang, L., Wang, B., Zhang, S., Yang, L., Cao, X., 2021. MICAL2 regulates myofibroblasts differentiation in epidural fibrosis via SRF/MRTF-A signaling pathway. *Life Sci* 269, 119045.

Jiménez-Altayó, F., Meirelles, T., Crosas-Molist, E., Sorolla, M.A., Del Blanco, D.G., López-Luque, J., Mas-Stachurska, A., Siegert, A.M., Bonorino, F., Barberà, L., García, C., Condom, E., Sitges, M., Rodríguez-Pascual, F., Laurindo, F., Schröder, K., Ros, J., Fabregat, I., Egea, G., 2018. Redox stress in Marfan syndrome: Dissecting the role of the NADPH oxidase NOX4 in aortic aneurysm. *Free radical biology & medicine* 118, 44-58.

Kim, G., Weiss, S.J., Levine, R.L., 2014. Methionine oxidation and reduction in proteins. *Biochimica et biophysica acta* 1840, 901-905.

Kim, H.Y., Gladyshev, V.N., 2005. Different catalytic mechanisms in mammalian selenocysteine- and cysteine-containing methionine-R-sulfoxide reductases. *PLoS biology* 3, e375.

Kim, J., Lee, H., Roh, Y.J., Kim, H.U., Shin, D., Kim, S., Son, J., Lee, A., Kim, M., Park, J., Hwang, S.Y., Kim, K., Lee, Y.K., Jung, H.S., Hwang, K.Y., Lee, B.C., 2020. Structural and kinetic insights into flavin-containing monooxygenase and calponin-homology domains in human MICAL3. *IUCr* 7, 90-99.

Kirilly, D., Gu, Y., Huang, Y., Wu, Z., Bashirullah, A., Low, B.C., Kolodkin, A.L., Wang, H., Yu, F., 2009. A genetic pathway composed of Sox14 and Mical governs severing of dendrites during pruning. *Nat Neurosci* 12, 1497-1505.

Klinkert, K., Echard, A., 2016. Rab35 GTPase: A Central Regulator of Phosphoinositides and F-actin in Endocytic Recycling and Beyond. *Traffic* 17, 1063-1077.

Kobayashi, H., Etoh, K., Ohbayashi, N., Fukuda, M., 2014. Rab35 promotes the recruitment of Rab8, Rab13 and Rab36 to recycling endosomes through MICAL-L1 during neurite outgrowth. *Biol Open* 3, 803-814.

Kommaddi, R.P., Tomar, D.S., Karunakaran, S., Bapat, D., Nanguneri, S., Ray, A., Schneider, B.L., Nair, D., Ravindranath, V., 2019. Glutaredoxin1 Diminishes Amyloid Beta-Mediated Oxidation of F-Actin and Reverses Cognitive Deficits in an Alzheimer's Disease Mouse Model. *Antioxid Redox Signal* 31, 1321-1338.

Kondrikov, D., Fonseca, F.V., Elms, S., Fulton, D., Black, S.M., Block, E.R., Su, Y., 2010. Beta-actin association with endothelial nitric-oxide synthase modulates nitric oxide and superoxide generation from the enzyme. *The Journal of biological chemistry* 285, 4319-4327.

Konstantinidis, K., Bezzerides, V.J., Lai, L., Isbell, H.M., Wei, A.C., Wu, Y., Viswanathan, M.C., Blum, I.D., Granger, J.M., Heims-Waldron, D., Zhang, D., Luczak, E.D., Murphy, K.R., Lu, F., Gratz, D.H., Manta, B., Wang, Q., Wang, Q., Kolodkin, A.L., Gladyshev, V.N., Hund, T.J., Pu, W.T., Wu, M.N., Cammarato, A., Bianchet, M.A., Shea, M.A., Levine, R.L., Anderson, M.E.,

2020. MICAL1 constrains cardiac stress responses and protects against disease by oxidizing CaMKII. *J Clin Invest* 130, 4663-4678.

Kouyama, T., Mihashi, K., 1981. Fluorimetry study of N-(1-pyrenyl)iodoacetamide-labelled F-actin. Local structural change of actin protomer both on polymerization and on binding of heavy meromyosin. *Eur J Biochem* 114, 33-38.

Kwon, T.J., Cho, H.J., Kim, U.K., Lee, E., Oh, S.K., Bok, J., Bae, Y.C., Yi, J.K., Lee, J.W., Ryoo, Z.Y., Lee, S.H., Lee, K.Y., Kim, H.Y., 2014. Methionine sulfoxide reductase B3 deficiency causes hearing loss due to stereocilia degeneration and apoptotic cell death in cochlear hair cells. *Hum Mol Genet* 23, 1591-1601.

Lassing, I., Schmitzberger, F., Björnstedt, M., Holmgren, A., Nordlund, P., Schutt, C.E., Lindberg, U., 2007. Molecular and structural basis for redox regulation of beta-actin. *J Mol Biol* 370, 331-348.

Lee, B.C., Peterfi, Z., Hoffmann, F.W., Moore, R.E., Kaya, A., Avanesov, A., Tarrago, L., Zhou, Y., Weerapana, E., Fomenko, D.E., Hoffmann, P.R., Gladyshev, V.N., 2013. MsrB1 and MICALs regulate actin assembly and macrophage function via reversible stereoselective methionine oxidation. *Mol Cell* 51, 397-404.

Lim, J.B., Huang, B.K., Deen, W.M., Sikes, H.D., 2015. Analysis of the lifetime and spatial localization of hydrogen peroxide generated in the cytosol using a reduced kinetic model. *Free radical biology & medicine* 89, 47-53.

Liu, Q., Borchering, N., Shao, P., Cao, H., Zhang, W., Qi, H.H., 2019. Identification of novel TGF- β regulated genes with pro-migratory roles. *Biochim Biophys Acta Mol Basis Dis* 1865, 165537.

Liu, Q., Liu, F., Yu, K.L., Tas, R., Grigoriev, I., Rimmelzwaal, S., Serra-Marques, A., Kapitein, L.C., Heck, A.J.R., Akhmanova, A., 2016. MICAL3 Flavoprotein Monooxygenase Forms a Complex with Centralspindlin and Regulates Cytokinesis. *Journal of Biological Chemistry* 291, 20617-20629.

Loria, R., Bon, G., Perotti, V., Gallo, E., Bersani, I., Baldassari, P., Porru, M., Leonetti, C., Di Carlo, S., Visca, P., Brizzi, M.F., Anichini, A., Mortarini, R., Falcioni, R., 2015. Sema6A and Mical1 control cell growth and survival of BRAFV600E human melanoma cells. *Oncotarget* 6, 2779-2793.

Lu, J., Holmgren, A., 2014. The thioredoxin antioxidant system. *Free radical biology & medicine* 66, 75-87.

Lucken-Ardjomande Häslér, S., Vallis, Y., Pasche, M., McMahan, H.T., 2020. GRAF2, WDR44, and MICAL1 mediate Rab8/10/11-dependent export of E-cadherin, MMP14, and CFTR Δ F508. *The Journal of cell biology* 219.

Lundquist, M.R., Storaska, A.J., Liu, T.C., Larsen, S.D., Evans, T., Neubig, R.R., Jaffrey, S.R., 2014. Redox modification of nuclear actin by MICAL-2 regulates SRF signaling. *Cell* 156, 563-576.

Luo, J., Xu, Y., Zhu, Q., Zhao, F., Zhang, Y., Peng, X., Wang, W., Wang, X., 2011. Expression pattern of Mical-1 in the temporal neocortex of patients with intractable temporal epilepsy and pilocarpine-induced rat model. *Synapse* 65, 1213-1221.

Mariotti, S., Barravecchia, I., Vindigni, C., Pucci, A., Balsamo, M., Libro, R., Senchenko, V., Dmitriev, A., Jacchetti, E., Cecchini, M., Roviello, F., Lai, M., Broccoli, V., Andreazzoli, M., Mazzanti, C.M., Angeloni, D., 2016. MICAL2 is a novel human cancer gene controlling mesenchymal to epithelial transition involved in cancer growth and invasion. *Oncotarget* 7, 1808-1825.

McGarry, D.J., Armstrong, G., Castino, G., Mason, S., Clark, W., Shaw, R., McGarry, L., Blyth, K., Olson, M.F., 2021. MICAL1 regulates actin cytoskeleton organization, directional cell migration and the growth of human breast cancer cells as orthotopic xenograft tumours. *Cancer Lett* 519, 226-236.

McGarry, D.J.e.a., 2021. MICAL1 activation by PAK1 mediates actin filament disassembly. *BioRxiv*. doi: <https://doi.org/10.1101/2021.09.15.460490>

Mierzwa, B., Gerlich, D.W., 2014. Cytokinetic Abscission: Molecular Mechanisms and Temporal Control. *Developmental cell* 31, 525-538.

Miller, Y.I., Chang, M.K., Funk, C.D., Feramisco, J.R., Witztum, J.L., 2001. 12/15-lipoxygenase translocation enhances site-specific actin polymerization in macrophages phagocytosing apoptotic cells. *The Journal of biological chemistry* 276, 19431-19439.

Milzani, A., Rossi, R., Di Simplicio, P., Giustarini, D., Colombo, R., DalleDonne, I., 2000. The oxidation produced by hydrogen peroxide on Ca-ATP-G-actin. *Protein Sci* 9, 1774-1782.

Morinaka, A., Yamada, M., Itofusa, R., Funato, Y., Yoshimura, Y., Nakamura, F., Yoshimura, T., Kaibuchi, K., Goshima, Y., Hoshino, M., Kamiguchi, H., Miki, H., 2011. Thioredoxin mediates oxidation-dependent phosphorylation of CRMP2 and growth cone collapse. *Sci Signal* 4, ra26.

Munnamalai, V., Weaver, C.J., Weisheit, C.E., Venkatraman, P., Agim, Z.S., Quinn, M.T., Suter, D.M., 2014. Bidirectional interactions between NOX2-type NADPH oxidase and the F-actin cytoskeleton in neuronal growth cones. *J Neurochem* 130, 526-540.

Nadella, M., Bianchet, M.A., Gabelli, S.B., Barrila, J., Amzel, L.M., 2005. Structure and activity of the axon guidance protein MICAL. *Proceedings of the National Academy of Sciences of the United States of America* 102, 16830-16835.

Neumann, P., Gertzberg, N., Vaughan, E., Weisbrot, J., Woodburn, R., Lambert, W., Johnson, A., 2006. Peroxynitrite mediates TNF-alpha-induced endothelial barrier dysfunction and nitration of actin. *Am J Physiol Lung Cell Mol Physiol* 290, L674-L684.

Niu, F., Sun, K., Wei, W., Yu, C., Wei, Z., 2020. F-actin disassembly factor MICAL1 binding to Myosin Va mediates cargo unloading during cytokinesis. *Sci Adv* 6.

Nizak, C., Monier, S., del Nery, E., Moutel, S., Goud, B., Perez, F., 2003. Recombinant antibodies to the small GTPase Rab6 as conformation sensors. *Science* 300, 984-987.

Ogata, F.T., Branco, V., Vale, F.F., Coppo, L., 2021. Glutaredoxin: Discovery, redox defense and much more. *Redox Biol* 43, 101975.

Orr, B.O., Fetter, R.D., Davis, G.W., 2017. Retrograde semaphorin-plexin signalling drives homeostatic synaptic plasticity. *Nature* 550, 109-113.

Ortegón Salas, C., Schneider, K., Lillig, C.H., Gellert, M., 2020. Signal-regulated oxidation of proteins via MICAL. *Biochemical Society transactions* 48, 613-620.

Pak, V.V., Ezeriņa, D., Lyublinskaya, O.G., Pedre, B., Tyurin-Kuzmin, P.A., Mishina, N.M., Thauvin, M., Young, D., Wahni, K., Martínez Gache, S.A., Demidovich, A.D., Ermakova, Y.G., Maslova, Y.D., Shokhina, A.G., Eroglu, E., Bilan, D.S., Bogeski, I., Michel, T., Vríz, S., Messens, J., Belousov, V.V., 2020. Ultrasensitive Genetically Encoded Indicator for Hydrogen Peroxide Identifies Roles for the Oxidant in Cell Migration and Mitochondrial Function. *Cell Metab* 31, 642-653.e646.

Pang, Y., Zhang, H., Ai, H.W., 2022. Improved Red Fluorescent Redox Indicators for Monitoring Cytosolic and Mitochondrial Thioredoxin Redox Dynamics. *Biochemistry* 61, 377-384.

Perrin, B.J., Ervasti, J.M., 2010. The actin gene family: function follows isoform. *Cytoskeleton* 67, 630-634.

Petsalaki, E., Zachos, G., 2021. The Abscission Checkpoint: A Guardian of Chromosomal Stability. *Cells* 10.

Pollard, T.D., 2016. Actin and Actin-Binding Proteins. *Cold Spring Harbor perspectives in biology* 8.

Pu, B., Zhang, X., Yan, T., Li, Y., Liu, B., Jian, Z., Mahgoub, O.K., Gu, L., Xiong, X., Zou, N., 2021. MICAL2 Promotes Proliferation and Migration of Glioblastoma Cells Through TGF- β /p-Smad2/EMT-Like Signaling Pathway. *Front Oncol* 11, 735180.

Qi, C., Min, P., Wang, Q., Wang, Y., Song, Y., Zhang, Y., Bibi, M., Du, J., 2021. MICAL2 Contributes to Gastric Cancer Cell Proliferation by Promoting YAP Dephosphorylation and Nuclear Translocation. *Oxid Med Cell Longev* 2021, 9955717.

Qin, X.B., Zhang, W.J., Zou, L., Huang, P.J., Sun, B.J., 2016. Identification potential biomarkers in pulmonary tuberculosis and latent infection based on bioinformatics analysis. *BMC Infect Dis* 16, 500.

Rai, A., Oprisko, A., Campos, J., Fu, Y., Friese, T., Itzen, A., Goody, R.S., Gazdag, E.M., Müller, M.P., 2016. bMERB domains are bivalent Rab8 family effectors evolved by gene duplication. *eLife* 5.

Reth, M., 2002. Hydrogen peroxide as second messenger in lymphocyte activation. *Nat Immunol* 3, 1129-1134.

Rich, S.K., Baskar, R., Terman, J.R., 2021. Propagation of F-actin disassembly via Myosin15-Mical interactions. *Sci Adv* 7.

Rui, M., Ng, K.S., Tang, Q., Bu, S., Yu, F., 2020. Protein phosphatase PP2A regulates microtubule orientation and dendrite pruning in *Drosophila*. *EMBO Rep* 21, e48843.

Sakai, J., Li, J., Subramanian, K.K., Mondal, S., Bajrami, B., Hattori, H., Jia, Y., Dickinson, B.C., Zhong, J., Ye, K., Chang, C.J., Ho, Y.S., Zhou, J., Luo, H.R., 2012. Reactive oxygen species-induced actin glutathionylation controls actin dynamics in neutrophils. *Immunity* 37, 1037-1049.

Schmidt, E.F., Shim, S.O., Strittmatter, S.M., 2008. Release of MICAL autoinhibition by semaphorin-plexin signaling promotes interaction with collapsin response mediator protein. *The Journal of neuroscience : the official journal of the Society for Neuroscience* 28, 2287-2297.

Schnorrer, F., Schönbauer, C., Langer, C.C., Dietzl, G., Novatchkova, M., Schernhuber, K., Fellner, M., Azaryan, A., Radolf, M., Stark, A., Keleman, K., Dickson, B.J., 2010. Systematic genetic analysis of muscle morphogenesis and function in *Drosophila*. *Nature* 464, 287-291.

Schopfer, F.J., Baker, P.R., Freeman, B.A., 2003. NO-dependent protein nitration: a cell signaling event or an oxidative inflammatory response? *Trends in biochemical sciences* 28, 646-654.

Shartava, A., Monteiro, C.A., Bencsath, F.A., Schneider, K., Chait, B.T., Gussio, R., Casoria-Scott, L.A., Shah, A.K., Heuerman, C.A., Goodman, S.R., 1995. A posttranslational modification of beta-actin contributes to the slow dissociation of the spectrin-protein 4.1-actin complex of irreversibly sickled cells. *The Journal of cell biology* 128, 805-818.

Shi, W., Ye, B., Rame, M., Wang, Y., Cioca, D., Reibel, S., Peng, J., Qi, S., Vitale, N., Luo, H., Wu, J., 2020. The receptor tyrosine kinase EPHB6 regulates catecholamine exocytosis in adrenal gland chromaffin cells. *The Journal of biological chemistry* 295, 7653-7668.

Siebold, C., Berrow, N., Walter, T.S., Harlos, K., Owens, R.J., Stuart, D.I., Terman, J.R., Kolodkin, A.L., Pasterkamp, R.J., Jones, E.Y., 2005. High-resolution structure of the catalytic region of MICAL (molecule interacting with CasL), a multidomain flavoenzyme-signaling

molecule. *Proceedings of the National Academy of Sciences of the United States of America* 102, 16836-16841.

Sies, H., Chance, B., 1970. The steady state level of catalase compound I in isolated hemoglobin-free perfused rat liver. *FEBS letters* 11, 172-176.

Sies, H., Jones, D.P., 2020. Reactive oxygen species (ROS) as pleiotropic physiological signalling agents. *Nature reviews. Molecular cell biology* 21, 363-383.

Sobierajska, K., Skurzynski, S., Stasiak, M., Kryczka, J., Cierniewski, C.S., Swiatkowska, M., 2014. Protein disulfide isomerase directly interacts with β -actin Cys374 and regulates cytoskeleton reorganization. *The Journal of biological chemistry* 289, 5758-5773.

Steinmetz, M.O., Goldie, K.N., Aebi, U., 1997. A correlative analysis of actin filament assembly, structure, and dynamics. *The Journal of cell biology* 138, 559-574.

Stournaras, C., Drewes, G., Blackholm, H., Merkle, I., Faulstich, H., 1990. Glutathionyl(cysteine-374) actin forms filaments of low mechanical stability. *Biochimica et biophysica acta* 1037, 86-91.

Su, Y., Kondrikov, D., Block, E.R., 2007. Beta-actin: a regulator of NOS-3. *Sci STKE* 2007, pe52.

Suzuki, T., Nakamoto, T., Ogawa, S., Seo, S., Matsumura, T., Tachibana, K., Morimoto, C., Hirai, H., 2002. MICAL, a novel CasL interacting molecule, associates with vimentin. *The Journal of biological chemistry* 277, 14933-14941.

Takamoto, K., Kamal, J.K., Chance, M.R., 2007. Biochemical implications of a three-dimensional model of monomeric actin bound to magnesium-chelated ATP. *Structure* 15, 39-51.

Tamura, M., Kanno, M., Endo, Y., 2000. Deactivation of neutrophil NADPH oxidase by actin-depolymerizing agents in a cell-free system. *Biochem J* 349, 369-375.

Tang, J.X., Janmey, P.A., Stossel, T.P., Ito, T., 1999. Thiol oxidation of actin produces dimers that enhance the elasticity of the F-actin network. *Biophys J* 76, 2208-2215.

Tang, S., Huang, X., Jiang, H., Qin, S., 2021. Identification of a Five-Gene Prognostic Signature Related to B Cells Infiltration in Pancreatic Adenocarcinoma. *Int J Gen Med* 14, 5051-5068.

Tao, W., Sun, W., Zhu, H., Zhang, J., 2019. miR-205-5p suppresses pulmonary vascular smooth muscle cell proliferation by targeting MICAL2-mediated Erk1/2 signaling. *Microvasc Res* 124, 43-50.

Tarrago, L., Gladyshev, V.N., 2012. Recharging oxidative protein repair: catalysis by methionine sulfoxide reductases towards their amino acid, protein, and model substrates. *Biochemistry. Biokhimiia* 77, 1097-1107.

Terman, J.R., Kashina, A., 2013. Post-translational modification and regulation of actin. *Current opinion in cell biology* 25, 30-38.

Terman, J.R., Mao, T., Pasterkamp, R.J., Yu, H.H., Kolodkin, A.L., 2002. MICALs, a family of conserved flavoprotein oxidoreductases, function in plexin-mediated axonal repulsion. *Cell* 109, 887-900.

Terzi, A., Suter, D.M., 2020. The role of NADPH oxidases in neuronal development. *Free radical biology & medicine* 154, 33-47.

Tominaga, K., Minato, H., Murayama, T., Sasahara, A., Nishimura, T., Kiyokawa, E., Kanauchi, H., Shimizu, S., Sato, A., Nishioka, K., Tsuji, E.I., Yano, M., Ogawa, T., Ishii, H., Mori, M., Akashi, K., Okamoto, K., Tanabe, M., Tada, K.I., Tojo, A., Gotoh, N., 2019. Semaphorin signaling via MICAL3 induces symmetric cell division to expand breast cancer stem-like cells. *Proceedings of the National Academy of Sciences of the United States of America* 116, 625-630.

Tufro, A., 2017. Podocyte Shape Regulation by Semaphorin 3A and MICAL-1. *Methods Mol Biol* 1493, 393-399.

Usatyuk, P.V., Romer, L.H., He, D., Parinandi, N.L., Kleinberg, M.E., Zhan, S., Jacobson, J.R., Dudek, S.M., Pendyala, S., Garcia, J.G., Natarajan, V., 2007. Regulation of hyperoxia-induced NADPH oxidase activation in human lung endothelial cells by the actin cytoskeleton and cortactin. *The Journal of biological chemistry* 282, 23284-23295.

Van Battum, E.Y., Gunput, R.A., Lemstra, S., Groen, E.J., Yu, K.L., Adolfs, Y., Zhou, Y., Hoogenraad, C.C., Yoshida, Y., Schachner, M., Akhmanova, A., Pasterkamp, R.J., 2014. The intracellular redox protein MICAL-1 regulates the development of hippocampal mossy fibre connections. *Nat Commun* 5, 4317.

Vanoni, M.A., 2017. Structure-function studies of MICAL, the unusual multidomain flavoenzyme involved in actin cytoskeleton dynamics. *Arch Biochem Biophys* 632, 118-141.

Varland, S., Vandekerckhove, J., Drazic, A., 2019. Actin Post-translational Modifications: The Cinderella of Cytoskeletal Control. *Trends in biochemical sciences* 44, 502-516.

Vitali, T., Maffioli, E., Tedeschi, G., Vanoni, M.A., 2016. Properties and catalytic activities of MICAL1, the flavoenzyme involved in cytoskeleton dynamics, and modulation by its CH, LIM and C-terminal domains. *Arch Biochem Biophys* 593, 24-37.

Vukelic, S., Xu, Q., Seidel-Rogol, B., Faidley, E.A., Dikalova, A.E., Hilenski, L.L., Jorde, U., Poole, L.B., Lassègue, B., Zhang, G., Griendling, K.K., 2018. NOX4 (NADPH Oxidase 4) and Poldip2 (Polymerase δ -Interacting Protein 2) Induce Filamentous Actin Oxidation and Promote Its Interaction With Vinculin During Integrin-Mediated Cell Adhesion. *Arterioscler Thromb Vasc Biol* 38, 2423-2434.

Wang, F., Chen, X., Cheng, H., Song, L., Liu, J., Caplan, S., Zhu, L., Wu, J.Y., 2021a. MICAL2PV suppresses the formation of tunneling nanotubes and modulates mitochondrial trafficking. *EMBO Rep* 22, e52006.

Wang, J., Boja, E.S., Tan, W., Tekle, E., Fales, H.M., English, S., Mieyal, J.J., Chock, P.B., 2001. Reversible glutathionylation regulates actin polymerization in A431 cells. *The Journal of biological chemistry* 276, 47763-47766.

Wang, X., Ling, S., Zhao, D., Sun, Q., Li, Q., Wu, F., Nie, J., Qu, L., Wang, B., Shen, X., Bai, Y., Li, Y., Li, Y., 2010. Redox regulation of actin by thioredoxin-1 is mediated by the interaction of the proteins via cysteine 62. *Antioxid Redox Signal* 13, 565-573.

Wang, Y., Deng, W., Zhang, Y., Sun, S., Zhao, S., Chen, Y., Zhao, X., Liu, L., Du, J., 2018. MICAL2 promotes breast cancer cell migration by maintaining epidermal growth factor receptor (EGFR) stability and EGFR/P38 signalling activation. *Acta Physiol (Oxf)* 222.

Wang, Y., Min, P., Qi, C., Zhao, S., Yu, M., Zhang, Y., Du, J., 2021b. MICAL2 Facilitates Gastric Cancer Cell Migration via MRTF-A-Mediated CDC42 Activation. *Front Mol Biosci* 8, 568868.

Weide, T., Teuber, J., Bayer, M., Barnekow, A., 2003. MICAL-1 isoforms, novel rab1 interacting proteins. *Biochemical and biophysical research communications* 306, 79-86.

Wilson, C., Muñoz-Palma, E., Henríquez, D.R., Palmisano, I., Núñez, M.T., Di Giovanni, S., González-Billault, C., 2016a. A Feed-Forward Mechanism Involving the NOX Complex and RyR-Mediated Ca²⁺ Release During Axonal Specification. *The Journal of neuroscience : the official journal of the Society for Neuroscience* 36, 11107-11119.

Wilson, C., Terman, J.R., Gonzalez-Billault, C., Ahmed, G., 2016b. Actin filaments-A target for redox regulation. *Cytoskeleton* 73, 577-595.

Wioland, H., Frémont, S., Guichard, B., Echard, A., Jégou, A., Romet-Lemonne, G., 2021. Actin filament oxidation by MICAL1 suppresses protections from cofilin-induced disassembly. *EMBO Rep* 22, e50965.

Wioland, H., Guichard, B., Senju, Y., Myram, S., Lappalainen, P., Jegou, A., Romet-Lemonne, G., 2017. ADF/Cofilin Accelerates Actin Dynamics by Severing Filaments and Promoting Their Depolymerization at Both Ends. *Current biology : CB* 27, 1956-1967 e1957.

Wioland, H., Jegou, A., Romet-Lemonne, G., 2019. Torsional stress generated by ADF/cofilin on cross-linked actin filaments boosts their severing. *Proceedings of the National Academy of Sciences of the United States of America* 116, 2595-2602.

Wolterhoff, N., Gigengack, U., Rumpf, S., 2020. PP2A phosphatase is required for dendrite pruning via actin regulation in *Drosophila*. *EMBO Rep* 21, e48870.

Wu, H., Yesilyurt, H.G., Yoon, J., Terman, J.R., 2018. The MICALs are a Family of F-actin Dismantling Oxidoreductases Conserved from *Drosophila* to Humans. *Scientific reports* 8, 937.

Xu, C., Mao, L., Tian, H., Lin, S., Zhao, X., Lin, J., Li, D., Li, X., Mei, X., 2021a. MICAL1 (molecule interacting with CasL 1) protects oligodendrocyte cells from oxidative injury through regulating apoptosis, autophagy in spinal cord injury. *Neurosci Lett* 750, 135712.

Xu, D., Wang, Y., Liu, X., Zhou, K., Wu, J., Chen, J., Chen, C., Chen, L., Zheng, J., 2021b. Development and clinical validation of a novel 9-gene prognostic model based on multi-omics in pancreatic adenocarcinoma. *Pharmacol Res* 164, 105370.

Xu, Q., Huff, L.P., Fujii, M., Griendling, K.K., 2017. Redox regulation of the actin cytoskeleton and its role in the vascular system. *Free radical biology & medicine* 109, 84-107.

Xue, B., Robinson, R.C., 2013. Guardians of the actin monomer. *Eur J Cell Biol* 92, 316-332.

Yoon, J., Kim, S.B., Ahmed, G., Shay, J.W., Terman, J.R., 2017. Amplification of F-Actin Disassembly and Cellular Repulsion by Growth Factor Signaling. *Developmental cell* 42, 117-129.e118.

Zhang, Z., Liu, R., Wang, Y., Wang, Y., Shuai, Y., Ke, C., Jin, R., Wang, X., Luo, J., 2022. Phosphorylation of MICAL2 by ARG promotes head and neck cancer tumorigenesis by regulating skeletal rearrangement. *Oncogene* 41, 334-346.

Zhao, S., Min, P., Liu, L., Zhang, L., Zhang, Y., Wang, Y., Zhao, X., Ma, Y., Xie, H., Zhu, C., Jiang, H., Du, J., Gu, L., 2019. NEDD9 Facilitates Hypoxia-Induced Gastric Cancer Cell Migration via MICAL1 Related Rac1 Activation. *Frontiers in pharmacology* 10, 291.

Zhou, W., Liu, Y., Gao, Y., Cheng, Y., Chang, R., Li, X., Zhou, Y., Wang, S., Liang, L., Duan, C., Zhang, C., 2020. MICAL2 is a novel nucleocytoplasmic shuttling protein promoting cancer invasion and growth of lung adenocarcinoma. *Cancer Lett* 483, 75-86.

Zhou, Y., Adolfs, Y., Pijnappel, W.W., Fuller, S.J., Van der Schors, R.C., Li, K.W., Sugden, P.H., Smit, A.B., Hergovich, A., Pasterkamp, R.J., 2011. MICAL-1 is a negative regulator of MST-NDR kinase signaling and apoptosis. *Mol Cell Biol* 31, 3603-3615.

Zschauer, T.C., Kunze, K., Jakob, S., Haendeler, J., Altschmied, J., 2011. Oxidative stress-induced degradation of thioredoxin-1 and apoptosis is inhibited by thioredoxin-1-actin interaction in endothelial cells. *Arterioscler Thromb Vasc Biol* 31, 650-656.

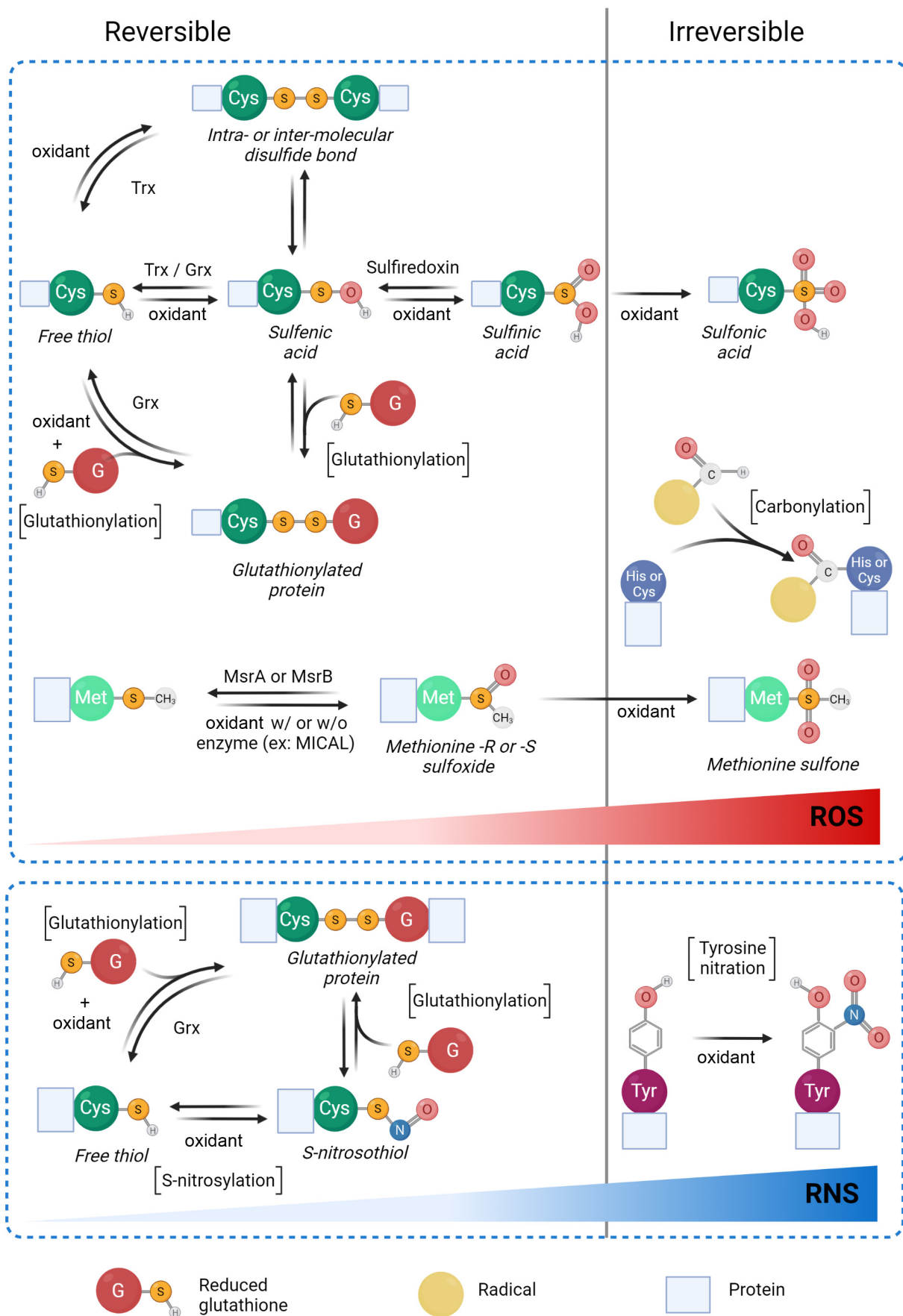

Figure 1

Figure 1: Reversible and irreversible redox modifications of proteins, including actin. ROS: Reactive Oxygen Species, RNS: Reactive Nitrogen Species, Trx: Thioredoxin, Grx: Glutaredoxin, MsrA: Methionine Sulfoxide Reductase A; MsrB: Methionine Sulfoxide Reductase B.

A

	amino acid residue in β actin
Tyrosine Nitration	Tyr53 Tyr69 Tyr91 Tyr198 Tyr218 Tyr240 Tyr294 Tyr362
Carbonylation	His40 His87 His173 Cys374
Disulfide bond	Cys285 Cys374
Glutathionylation	Cys217 Cys374
S-nitrosylation	Cys217 Cys257 Cys285 Cys374
Other oxidation	Cys17 Met44 Met47 Trp81 Met82 Trp88 Met178 Met190 Cys217 Met227 Cys257 Met269 Cys272 Cys285 Met235 Trp342 Met355 Trp358 Cys374

B**Figure 2**

Figure 2: Redox modifications of actin. (A) Amino acids and corresponding Redox modifications experimentally observed in actin. See also (Terman and Kashina, 2013; Varland et al., 2019) for non-redox modifications. **(B)** Redox PTMs of Amino acids further described in the review have been highlighted in an actin dimer. Orange : D-loop (DNase I binding loop), with both Met44 and Met47 shown with orange spheres; Red : C-terminal part of actin; Yellow: Cys 285, Cys374 (at the C-term part) shown with yellow spheres.

oxidation degree
of oxygen

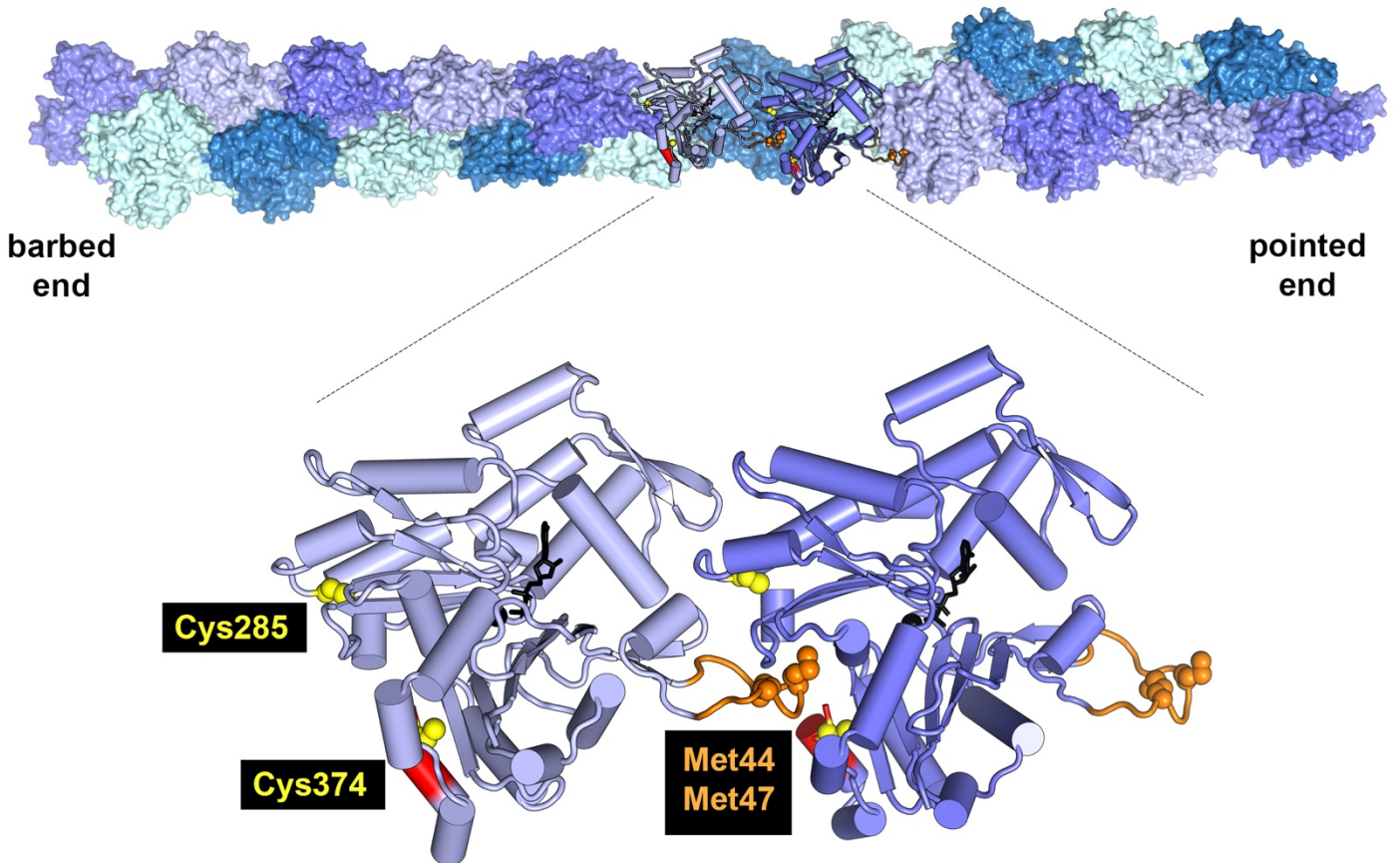
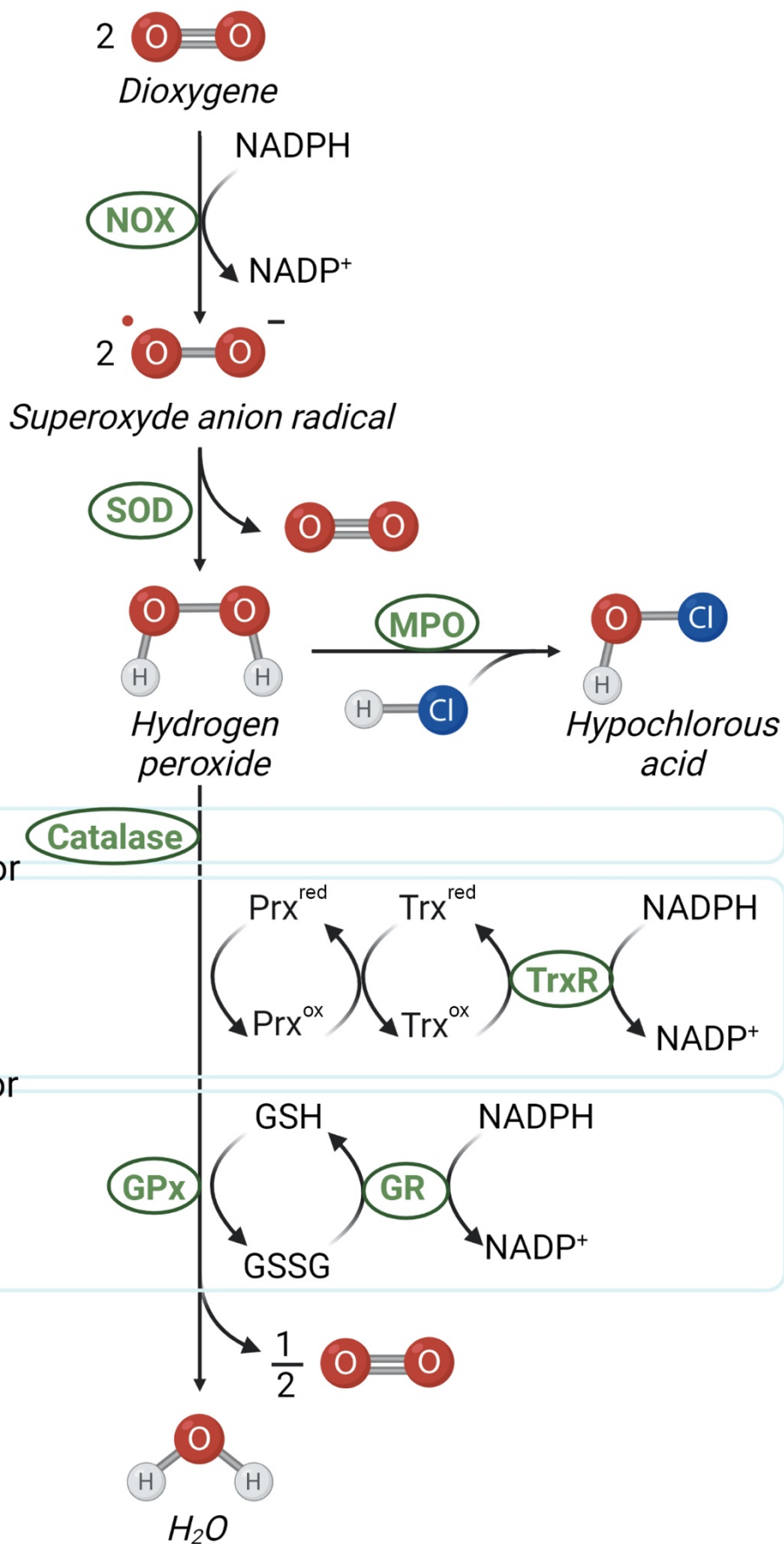
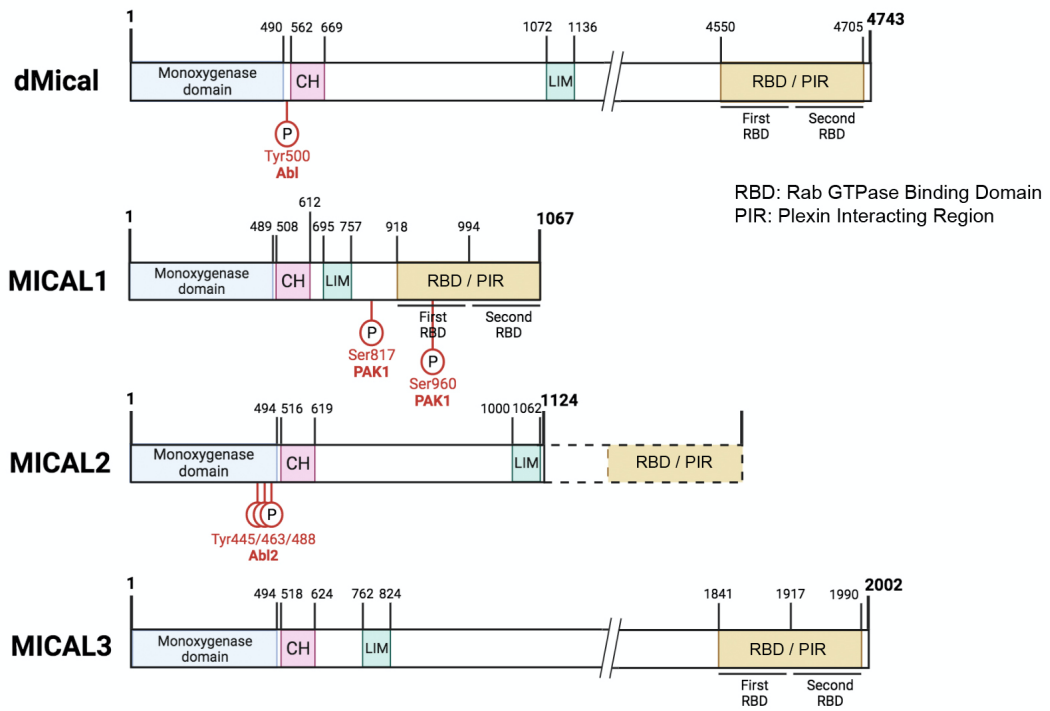

Figure 3

Figure 3: Selected origin and sinks of hydrogen peroxide in cells. Enzymes appear in green (note that other H₂O₂ producing enzymes exist in cells). NOX: NADPH oxidase; SOD: superoxide dismutase; MPO: myeloperoxidase; Prx^{ox}: oxidized form of peroxiredoxin; Prx^{red}: reduced form of peroxiredoxin; Trx^{ox}: oxidized form of thioredoxin; Trx^{red}: reduced form of thioredoxin; TrxR: thioredoxin reductase; GPx: glutathione peroxidase; GR: glutathione reductase.

A



B

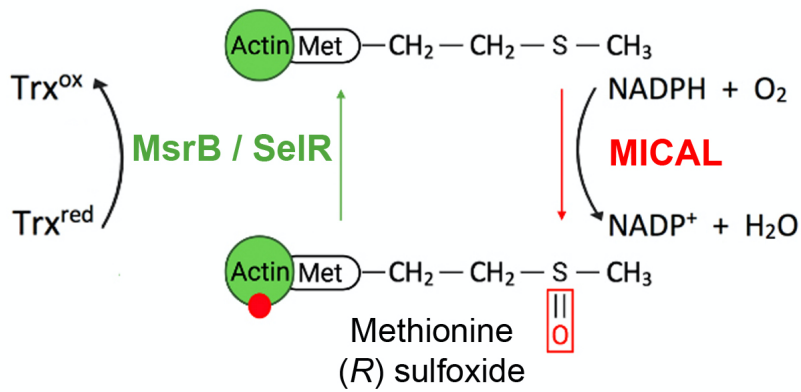

C

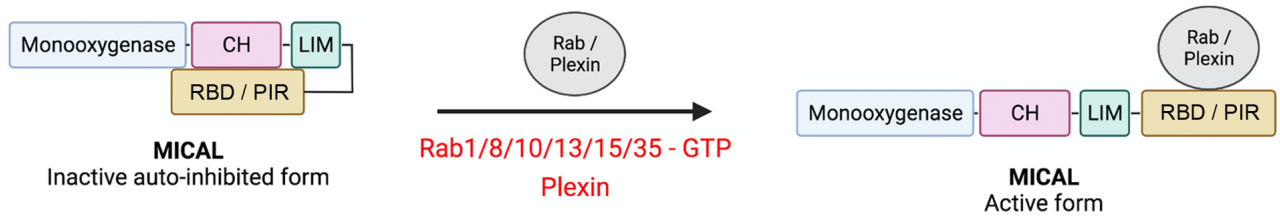

Figure 4

Figure 4: MICAL family enzymes. (A) MICAL family members in *Drosophila* and in humans. **(B)** Chemical reactions catalyzed by MICAL and MsrB/SelR. Note that the Methionine sulfoxide is only the R-stereoisomer. Trx^{ox}: oxidized form of thioredoxin; Trx^{red}: reduced form of thioredoxin. **(C)** Activation of MICAL enzymes. CH: calponin homology domain; LIM: Lin-11, Isl-1 and Mec-3; RBD: Rab binding domain.

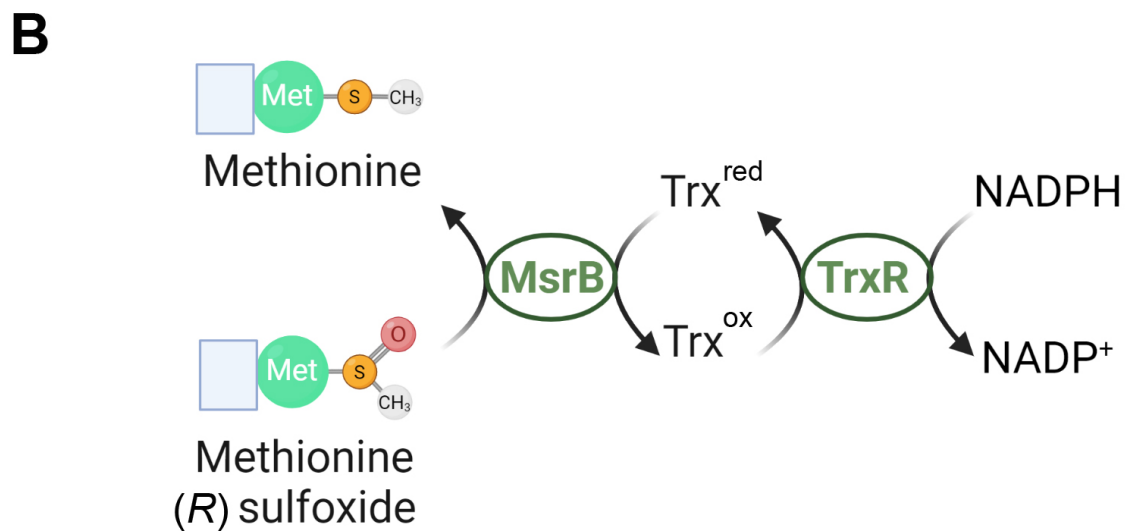
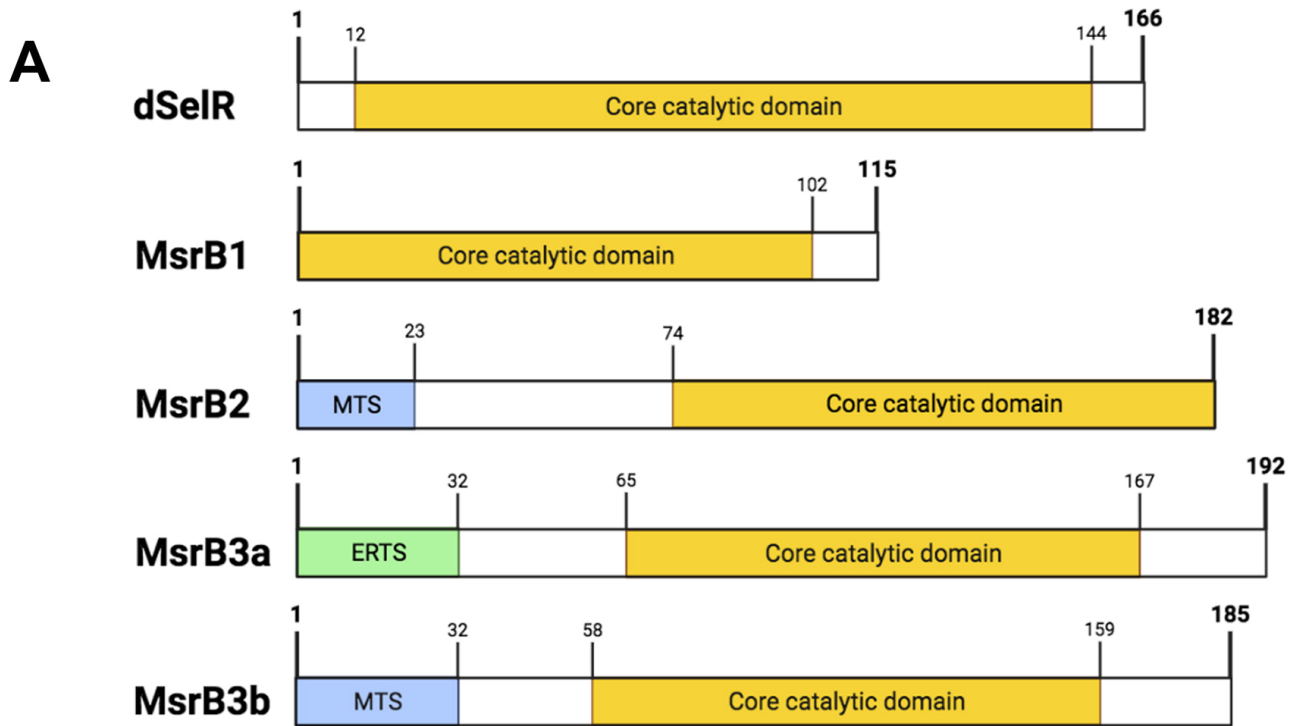

Figure 5

Figure 5: MsrB family enzymes. (A) Methionine sulfoxide reductase B family members in *Drosophila* (SelR) and in humans (MsrB1-B3). MTS: mitochondrial targeting sequence; ERTS: Endoplasmic Reticulum targeting sequence. **(B)** Source of electrons in the reduction reaction catalyzed by MsrBs. Trx^{ox}: oxidized form of thioredoxin; Trx^{red}: reduced form of thioredoxin; TrxR: thioredoxin reductase.

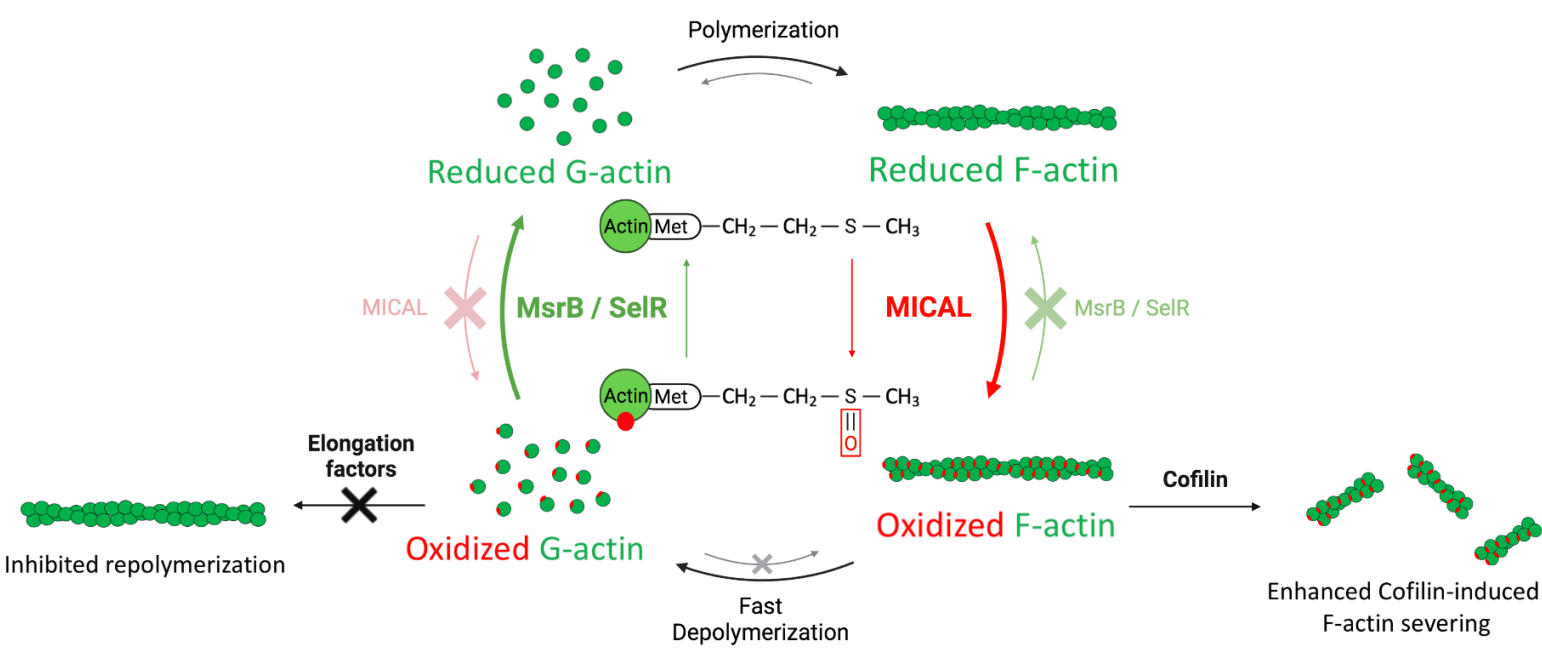

Figure 6

Figure 6: Pools of actin specifically oxidized by MICALs and reduced by SelR/MsrBs. Effects of oxidation and reduction on actin polymerization and interactions with ABPs.

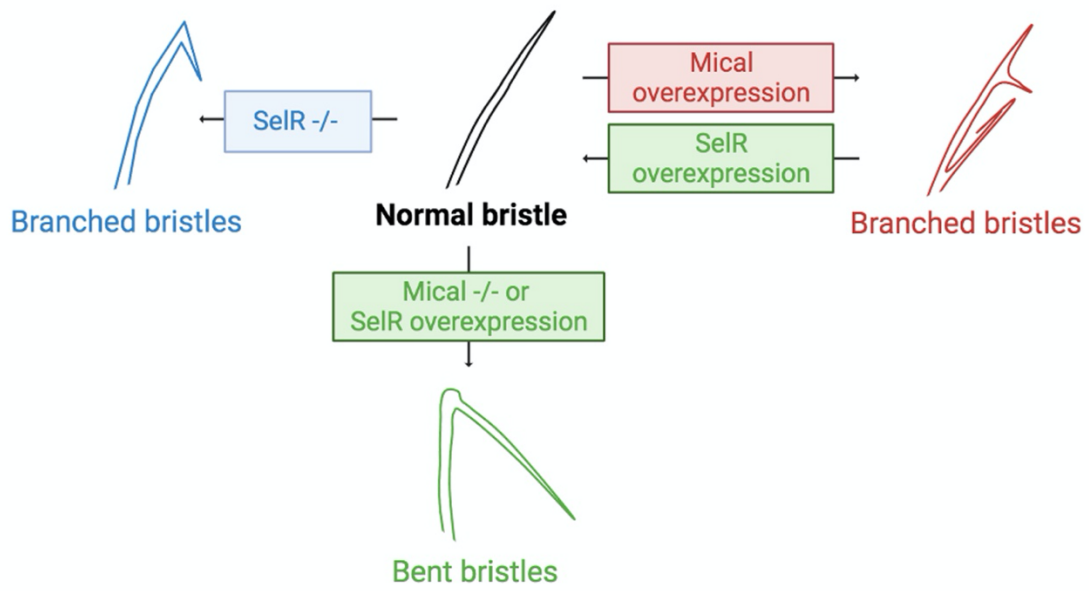
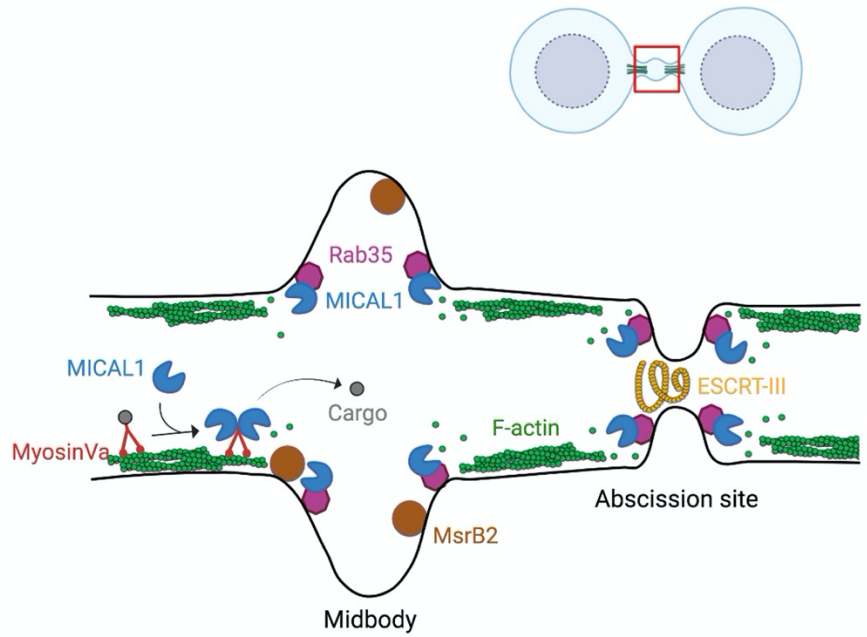
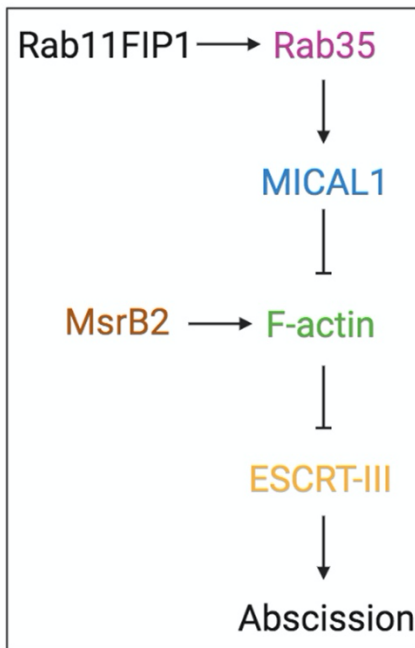
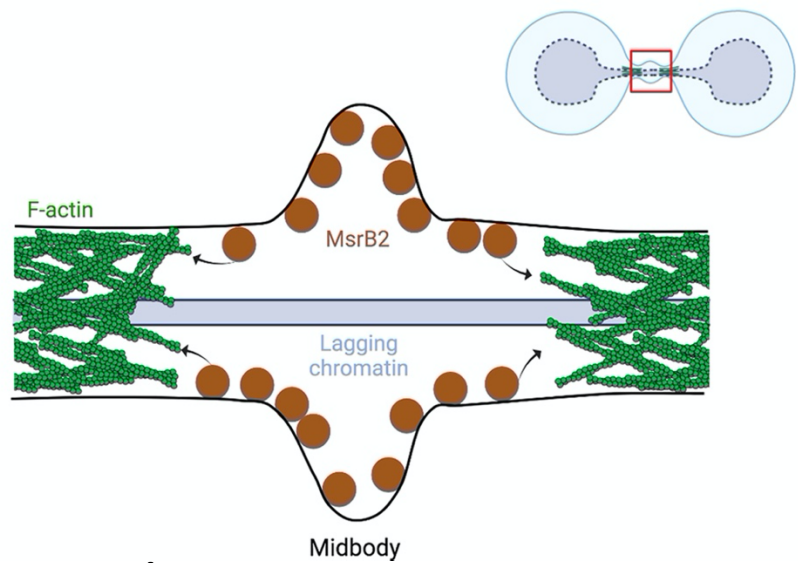
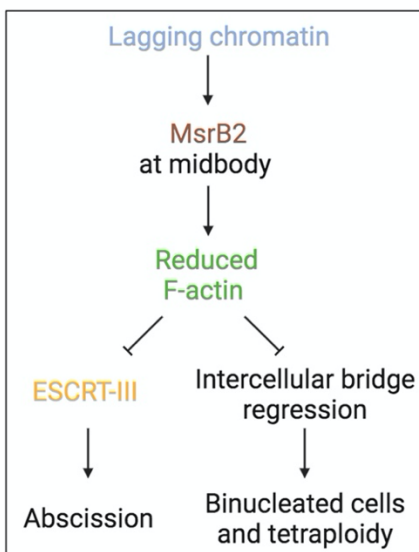
A**B****C****Figure 7**

Figure 7: Roles of MICALs and SelR/MsrB in two cellular functions: Bristle development in *Drosophila* **(A)** and Cytokinesis in normal conditions **(B)** or upon activation of the abscission checkpoint by lagging chromatin **(C)** in Human cells.