



HAL
open science

Structural and functional characterization of the Protein-O-MannosylTransferase of Mycobacterium tuberculosis

Chloé Rivière, Nicolas Géraud, Camille Falcou, Émeline Fabre, Michel Rivière

► **To cite this version:**

Chloé Rivière, Nicolas Géraud, Camille Falcou, Émeline Fabre, Michel Rivière. Structural and functional characterization of the Protein-O-MannosylTransferase of Mycobacterium tuberculosis. 2èmes Journées du GDR ChemBio, Jun 2022, Toulouse, France. . hal-03864459

HAL Id: hal-03864459

<https://cnrs.hal.science/hal-03864459v1>

Submitted on 21 Nov 2022

HAL is a multi-disciplinary open access archive for the deposit and dissemination of scientific research documents, whether they are published or not. The documents may come from teaching and research institutions in France or abroad, or from public or private research centers.

L'archive ouverte pluridisciplinaire **HAL**, est destinée au dépôt et à la diffusion de documents scientifiques de niveau recherche, publiés ou non, émanant des établissements d'enseignement et de recherche français ou étrangers, des laboratoires publics ou privés.

RIVIÈRE C., GERAUD N., FALCOU C., FABRE E., RIVIÈRE M.

Institute of Pharmacology and Structural Biology (IPBS), Centre National de la Recherche Scientifique (CNRS), UFTMIP-UPS
Department of Tuberculosis and Infection Biology, 205 Route de Narbonne, 31077 Toulouse, France

Introduction

"TB is among the top 10 causes of death...with the rise of antibiotic resistance making the threat more dangerous."

T. Adhanom Ghebreyesus, Director General of the World Health Organization; United Nation high-Level Meeting on Tuberculosis, Sept. 26th, 2018

Mycobacterium tuberculosis (Mtb)

- The etiologic agent of the human Tuberculosis (TB)
- 1,5 millions of deaths in 2020 (World Health Organization)
- Multi and extensively drug-resistant (MDR and XDR) strains emergence and spread
 - Urgent need for innovative drug development¹

Anti-virulence strategy is a promising approach for innovative therapeutics

- Targets non-essential virulence factor
- Less likely to cause resistance (doesn't affect pathogen's vital metabolic pathways)
- Minimal disruption of beneficial host microbiota unlike conventional antibiotics

Bacterial protein-O-mannosylation process as a new virulence factor of Mtb

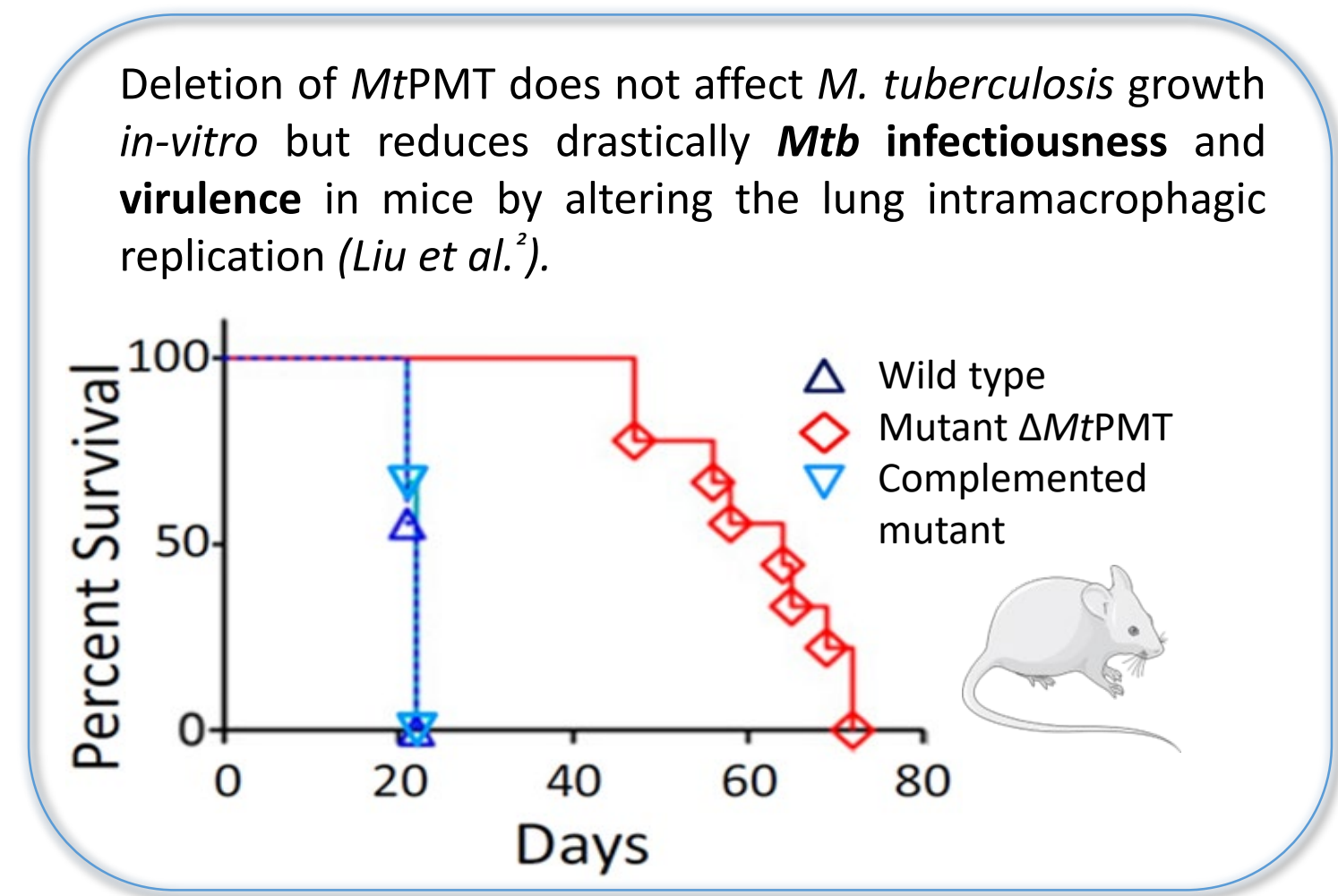
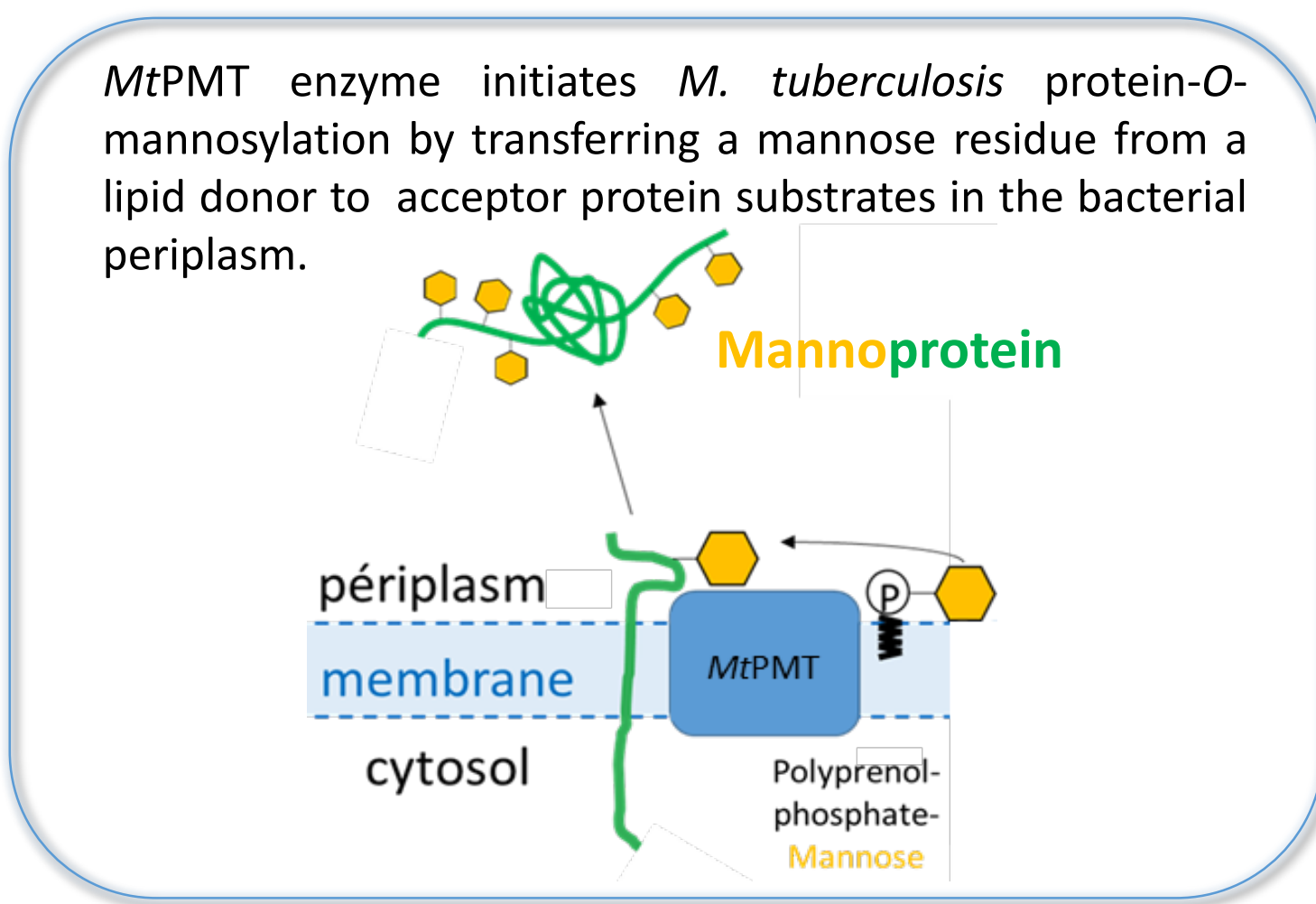

➢ MtPMT : Potential target to fight Tuberculosis

Major advantage: its pleiotropic effect prevents the emergence of drug-resistance³

Aim

Search for specific inhibitors of the *M. tuberculosis* MtPMT with potential therapeutic value (anti-virulence therapy).

Limitations

- MtPMT is an integral membrane protein
- O-Mannosylation process is a co-translocational modification of secreted proteins
- Protein-O-MannosylTransferase (PMT) activity detected in Actinobacteria, yeasts and animals
- Significant sequence homologies between eukaryote and prokaryote PMTs
- Human PMTs are essential (their mutations lead to congenital muscular dystrophies)

Approach

Deciphering of the MtPMT structure-function relationship by mutational analyses to identify specific features distinguishing the MtPMT from the eukaryote PMTs and that could be specifically targeted for *in-vivo* activity inhibition.

Result I: Understanding the molecular mechanism of MtPMT

MtPMT belongs to the C-Type GlycosylTransferase (GT-C) family. Sequence alignments of MtPMT with 6 GT-Cs (including 2 PMTs) with resolved 3D structures^{4,5,6,7,8} enabled the construction of a 3D model. MtPMT is predicted as a large polytopic membrane protein with 11 transmembrane helices (TMH), 5 cytosolic loops and 5 external loops (EL) associated to the mannosyl transferase activity in the periplasm.

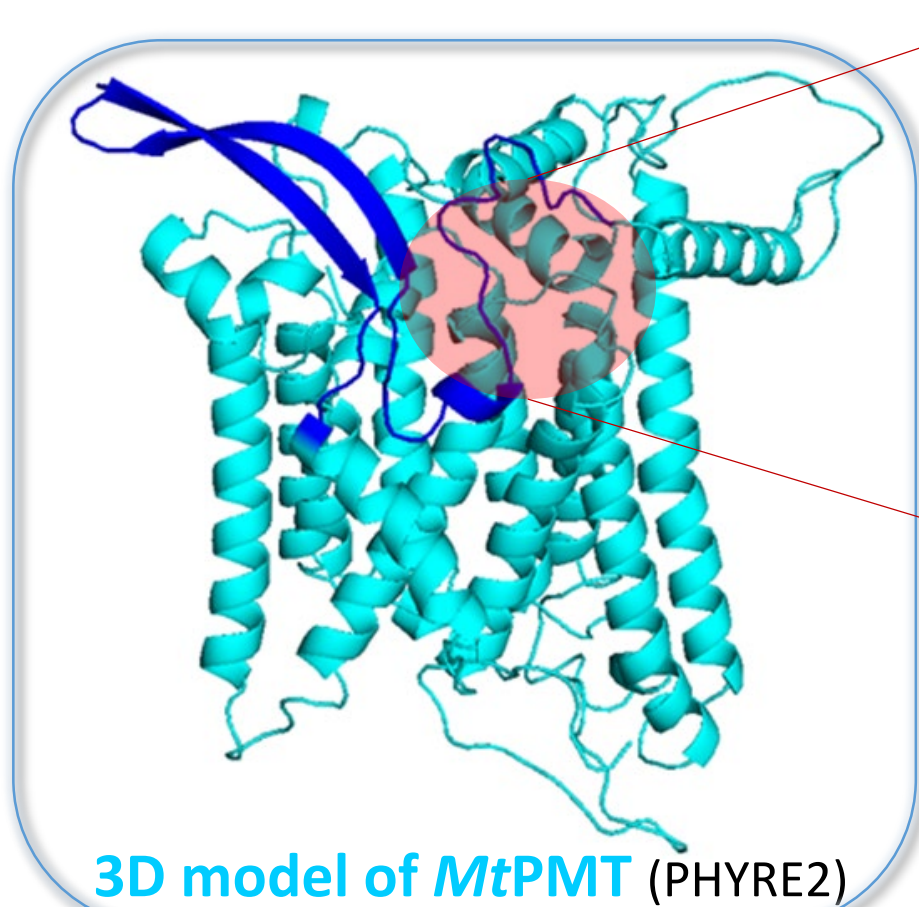
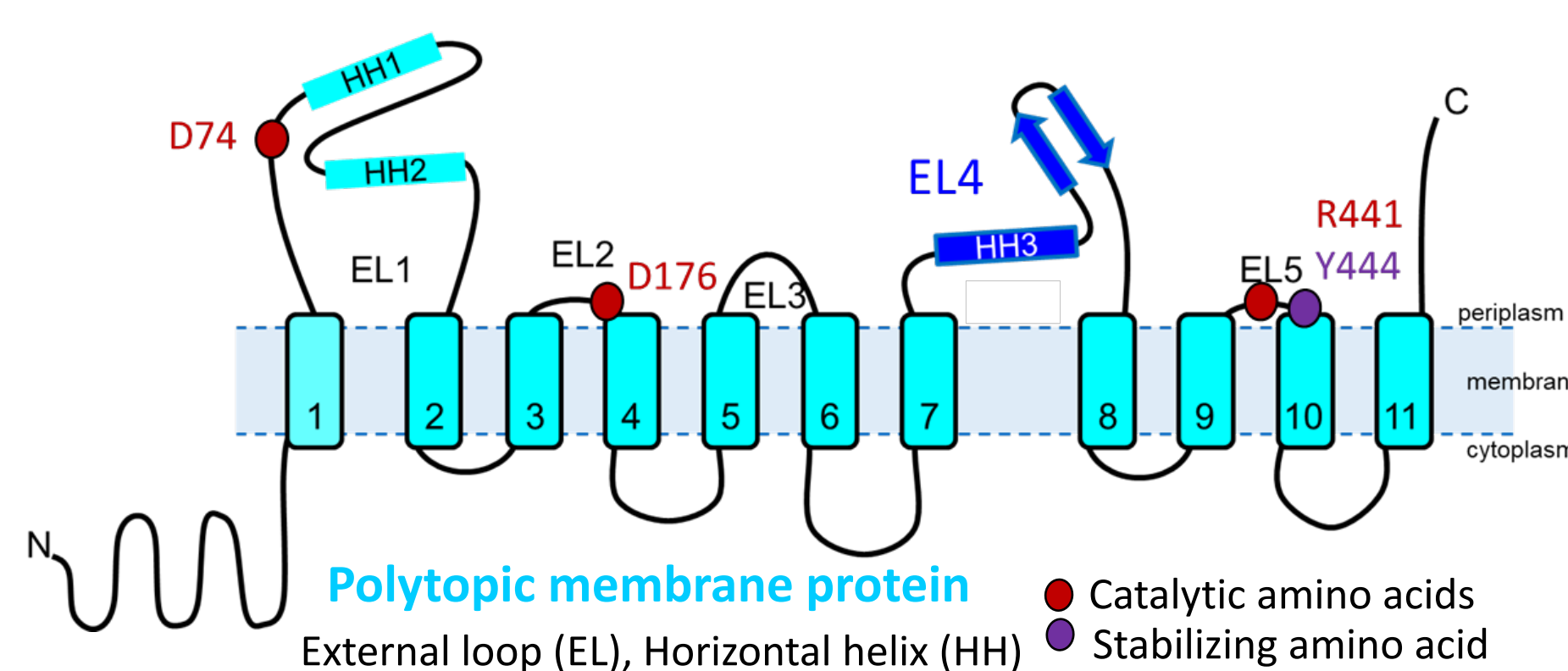

Catalytic triad of MtPMT : D74, D176 and R441

Residues described as catalytic in the GT-Cs are conserved within MtPMT sequence and appear to form a catalytic pocket in the 3D model.

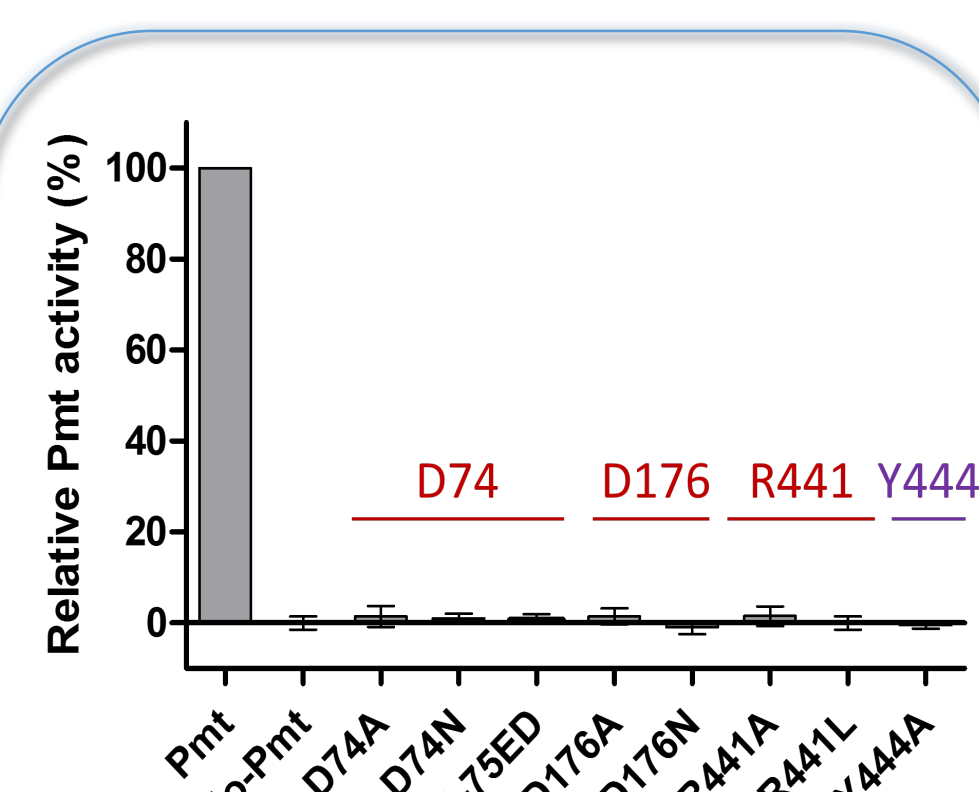

Disruption, by site-directed mutagenesis, of biochemical functions of D74, D176, R441 and Y444 residues prevents totally MtPMT catalysis in bacteria.

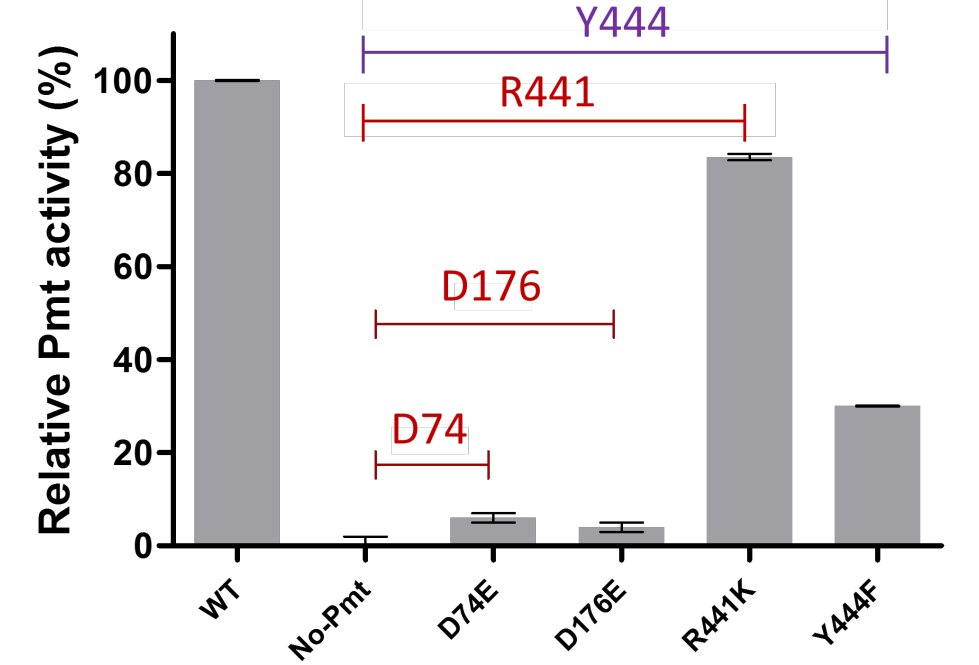

Substitutions by equivalent biochemical functions in mutants D74E, D176E, R441K and Y444F rescue partially the PMT activity.

Result II: Targeted restoration of the O-mannosylation process *in vivo*

Exogenous small chemicals crossing the bacterial periplasm can modulate MtPMT activity *in-vivo*.

Partial chemical rescue of the lack of activity of the MtPMT R441A mutant by treatment of living bacteria with basic exogenous compounds (imidazole or guanidinium) mimicking the missing side chain of arginine.

➢ MtPMT is a druggable target

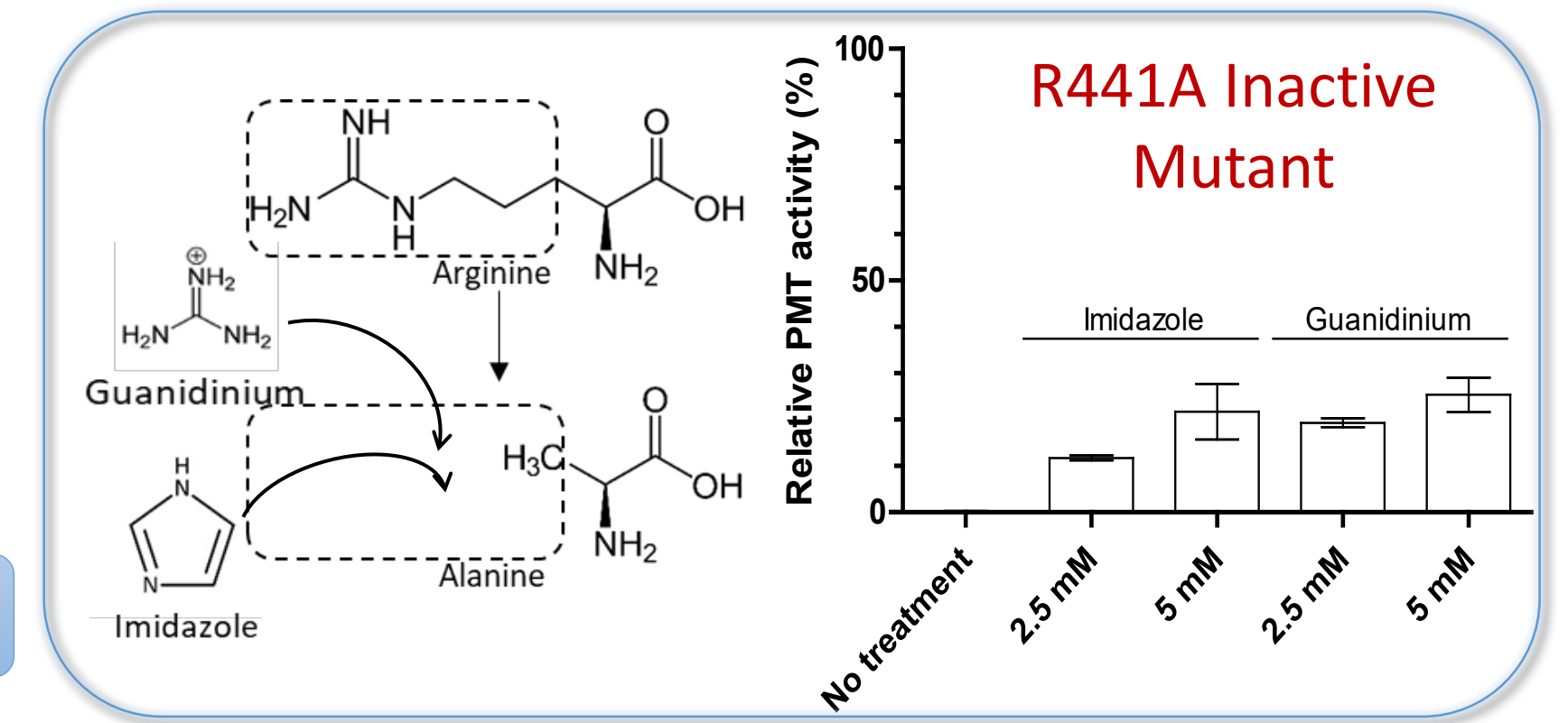

Result III: Search for a specific targetable domain of bacterial MtPMT

In order to identify targetable functional motifs specific to MtPMT, the structural differences with GT-Cs and with eukaryotic PMTs were explored revealing the external loop 4 (EL4) as the most divergent structural domain between bacterial and human PMTs.

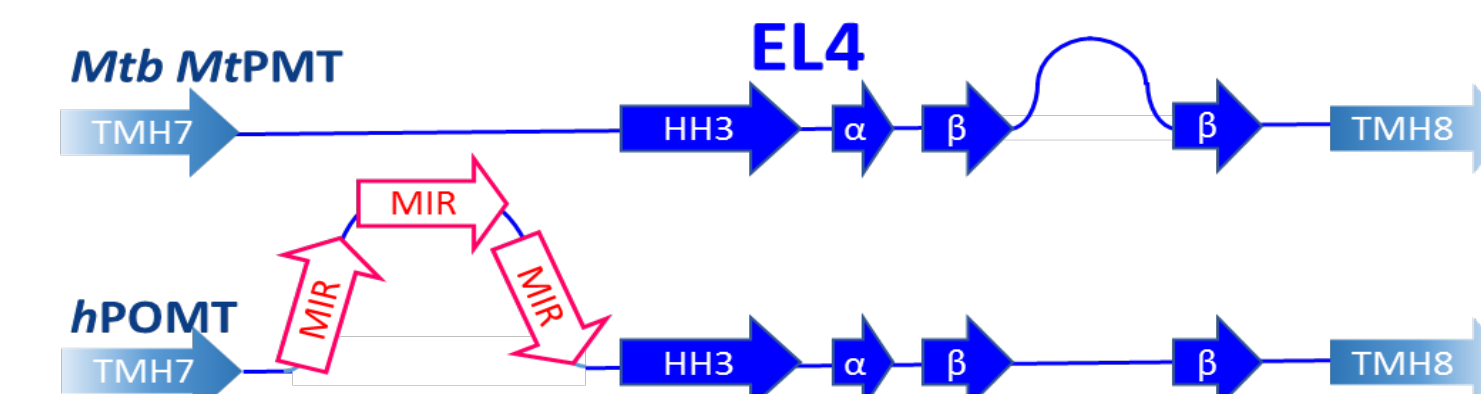

Eukaryote PMT's EL4 has 3 MIR domains⁸, which are absent in MtPMT making the bacterial EL4 shorter than its eucaryotes homologues.

The MtPMT-specific region EL4 shows substantial similarity with protein WW domains involved in protein-protein interactions through recognition of proline-rich peptides^{9,10}, very similar to the O-mannosylation site primary sequences targeted by MtPMT.

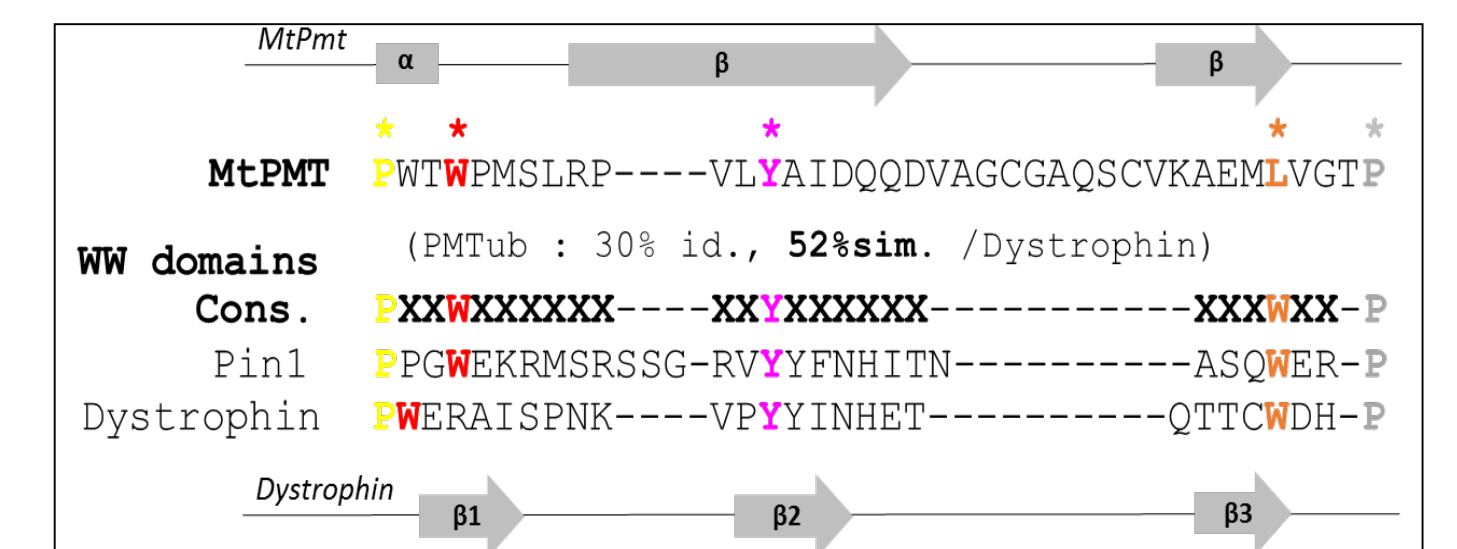

Sequence alignments indicating the consensus amino acids conserved in WW domains and in MtPMT EL4 (colors are reported in the 3D structure).

Evidences of the involvement of EL4 in the enzymatic activity of MtPMT.

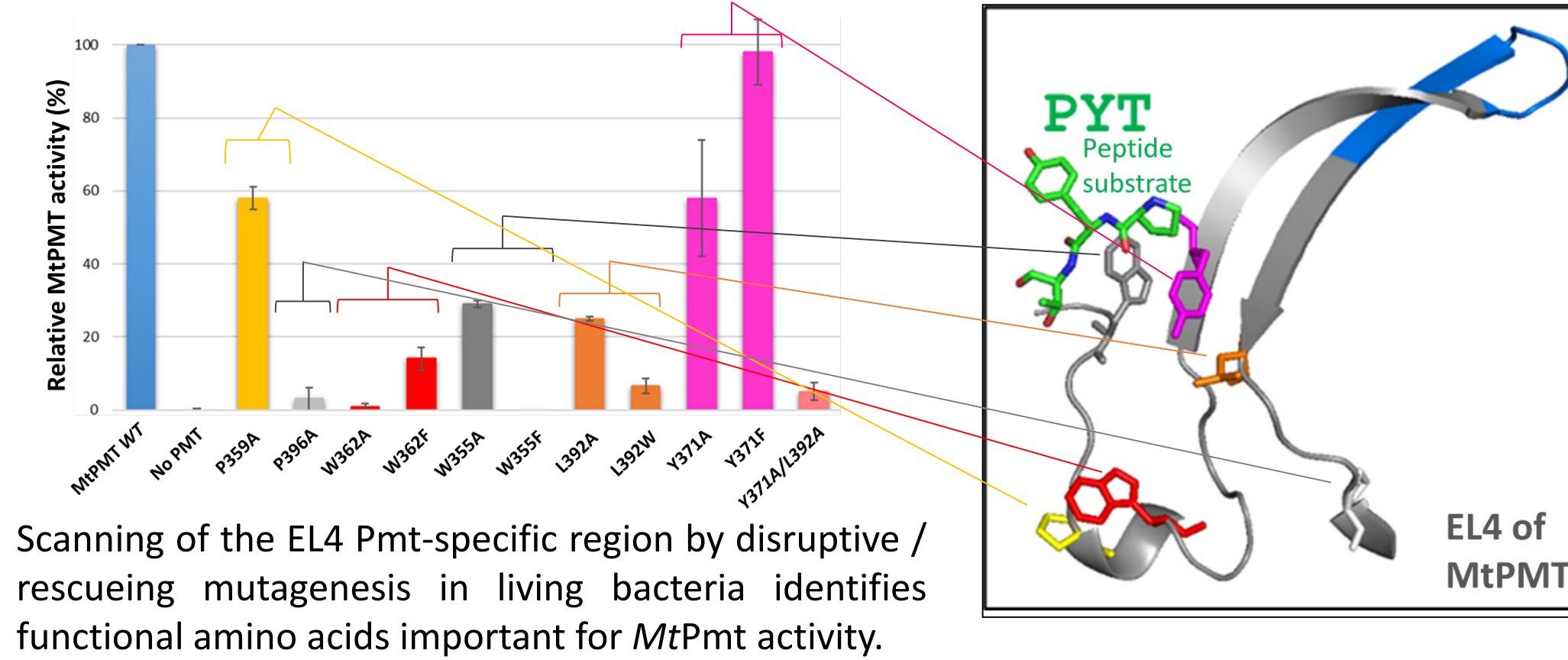

Scanning of the EL4 Pmt-specific region by disruptive / rescuing mutagenesis in living bacteria identifies functional amino acids important for MtPmt activity.

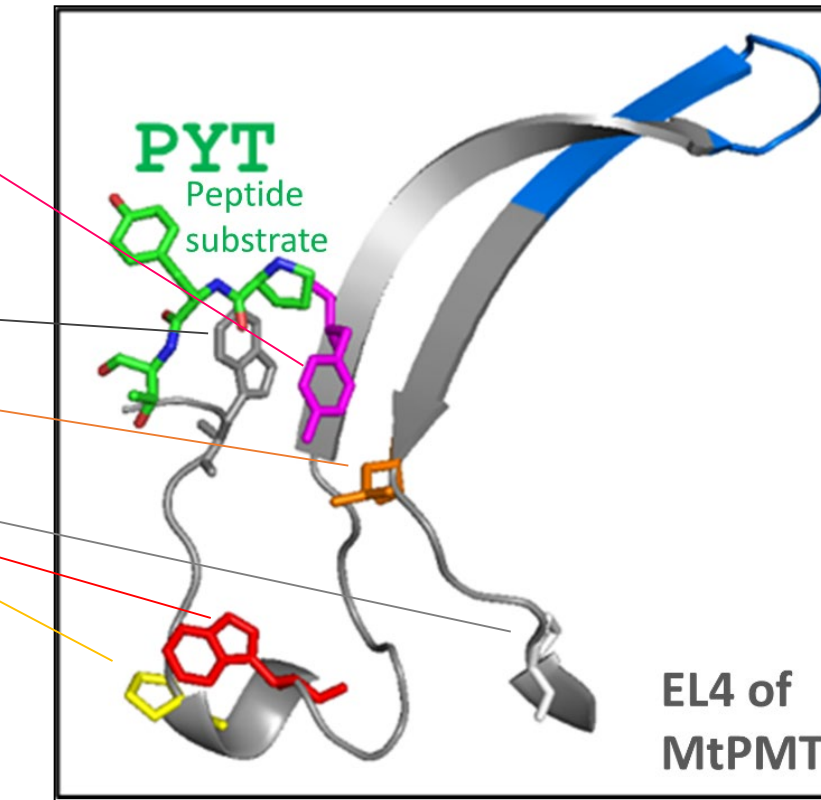

MtPMT EL4 3D model. Colored residues correspond to the consensus amino acids conserved in the WW domains. The blue region corresponds to an insert of 10 mycobacteria-specific residues. Docking simulation of the ScPmt2⁹ PYT peptide substrate (in green) in the MtPMT EL4 homologue domain model.

MtPMT EL4 may act as the site of interaction with protein substrates by recognizing glycosylation site proline-rich sequence as do WW domains.

➢ Specific targeting of EL4 protein-protein interactions could constitute a promising approach for selective inhibition of MtPMT activity.

Result IV: *In-vivo* targeting protein O-mannosylation with proline analogues

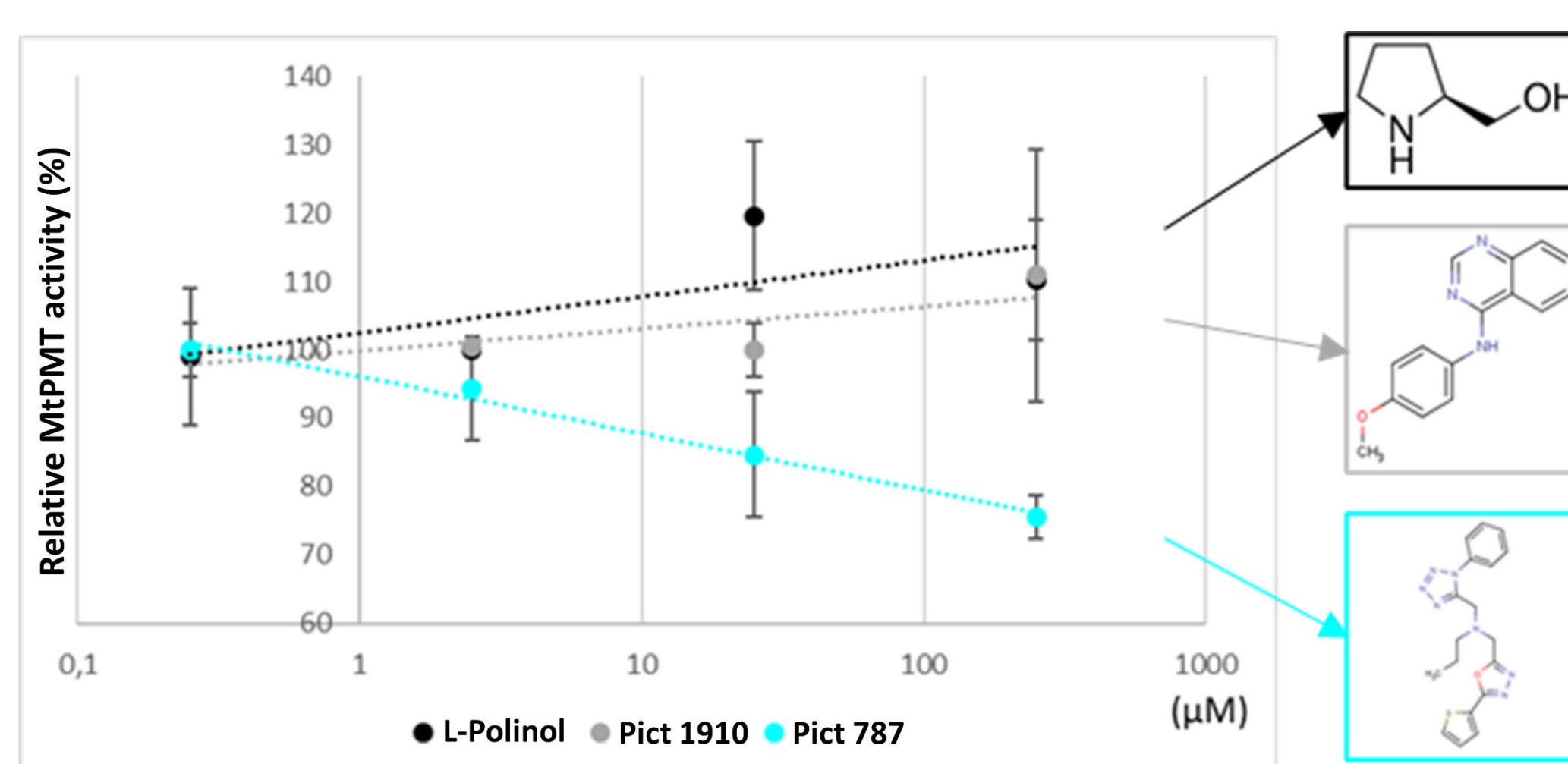

Chemical treatment of living bacteria with the compound Pict787, an analogue of proline-containing peptide, inhibits the WT-MtPMT activity up to 25% with a dose-effect without affecting bacterial growth.

➢ Analogues of proline-containing peptide affect protein O-mannosylation *in vivo*.

Conclusion

Due to the involvement of MtPMT in the virulence of *M. tuberculosis*, this enzyme constitutes a potential target for a future anti-virulence drug offering a new therapeutic way to fight against TB. Beyond TB, PMTs are implicated in the virulence of various pathogens and specific inhibition of MtPMT would provide a proof of concept for targeting PMTs in various pathologies.

Prospects

- Conformational analysis in solution of EL4 isolated domain : WW domains are autonomous modules able to interact with their substrates when isolated products in solution¹⁰. We will explore whether the primary sequence homology of MtPMT EL4 with WW domains induces similar behavior.
- This will open a new route for *in vitro* interaction studies between the isolated EL4 domain and a peptide substrate to demonstrate the role of this domain and its binding specificity to proline-rich substrates.

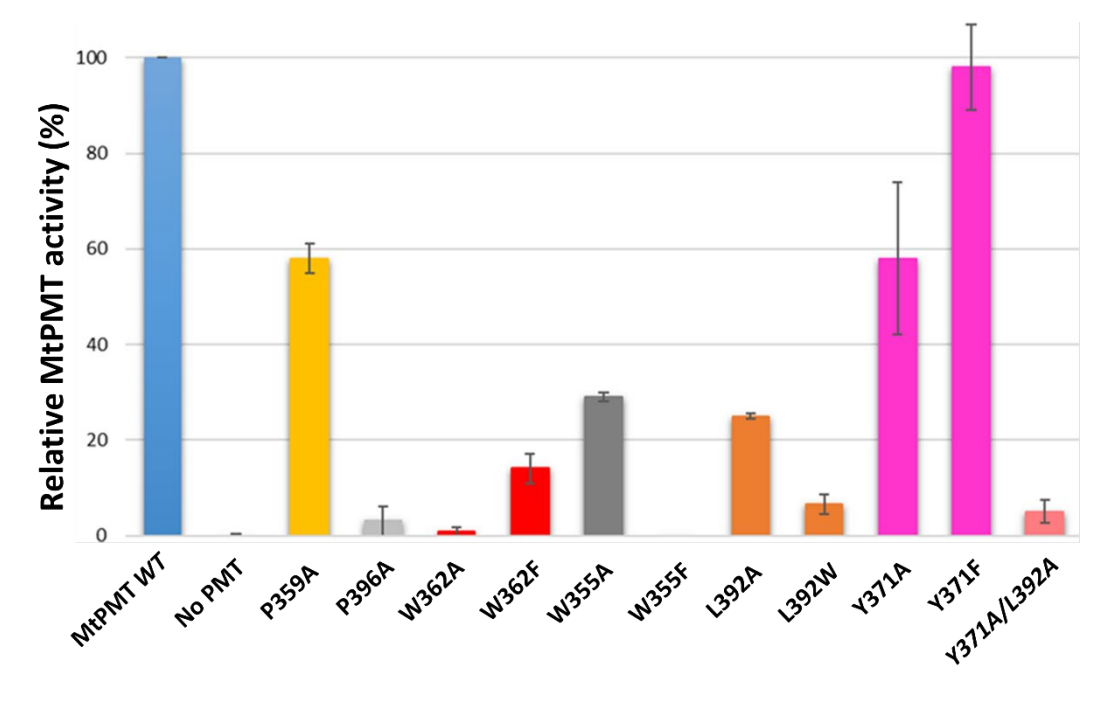
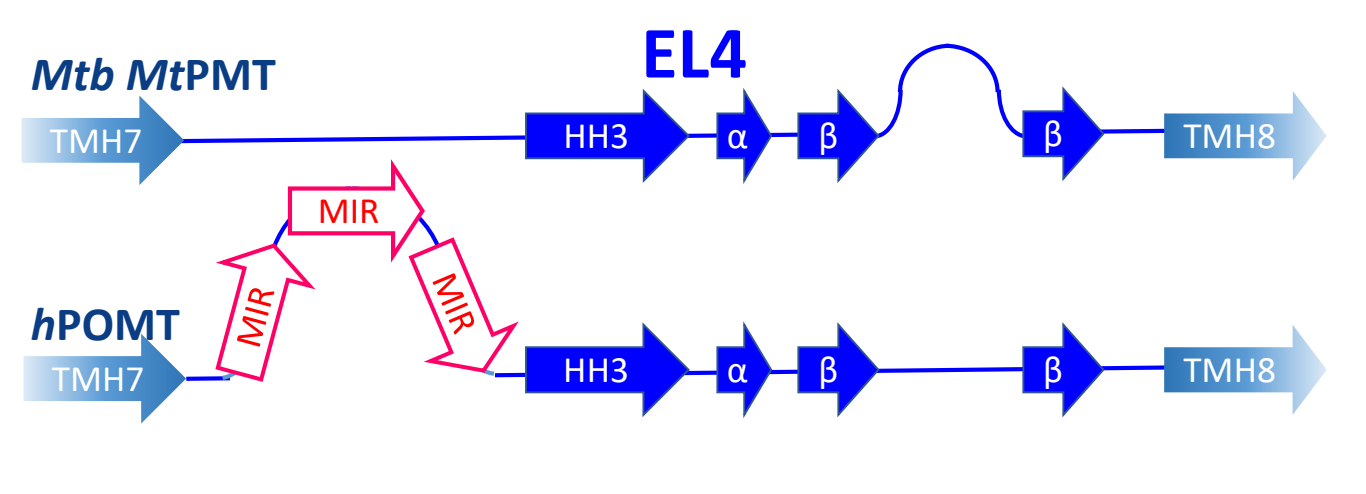
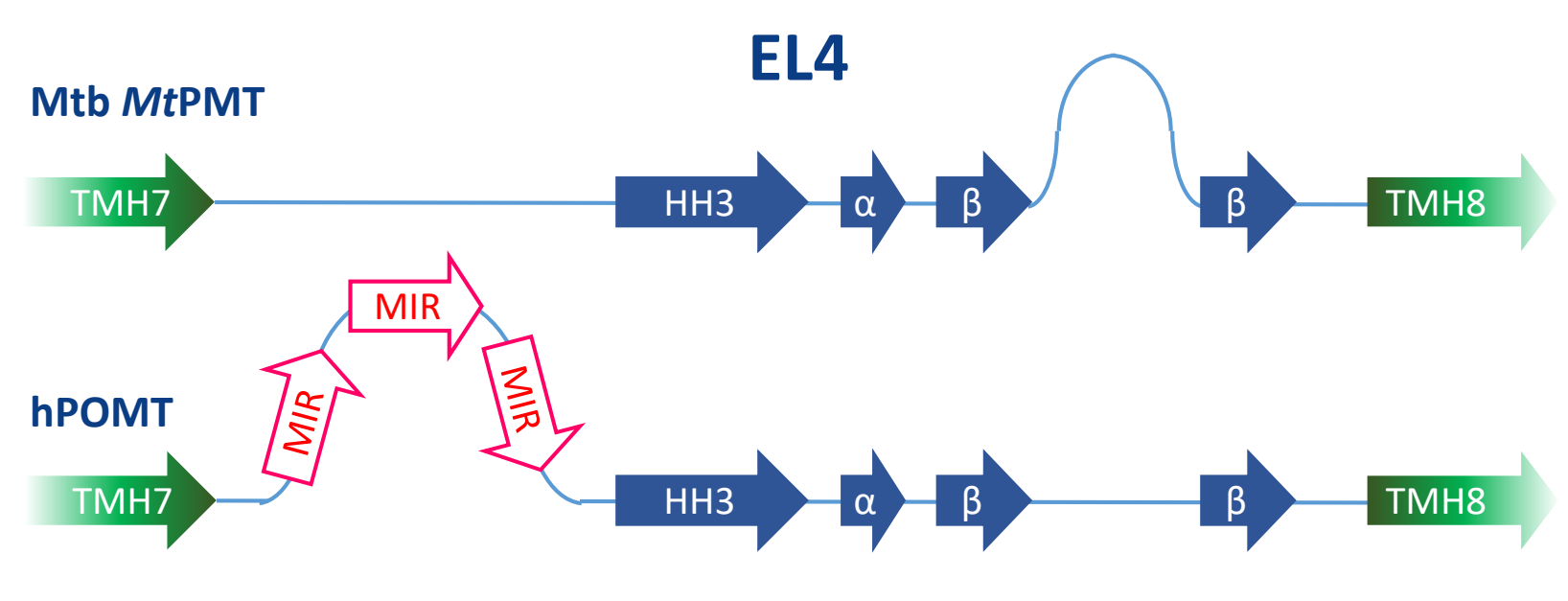

Structural and functional characterization of the Protein-O-MannosylTransferase of *Mycobacterium tuberculosis*

MtPMT : a potential target of innovative therapeutic inhibitors

RIVIÈRE C., GERAUD N., FALCOU C., FABRE E., RIVIÈRE M.

Institute of Pharmacology and Structural Biology (IPBS), Centre National de la Recherche Scientifique (CNRS), UFTMIP-UPS
Department of Tuberculosis and Infection Biology, 205 Route de Narbonne, 31077 Toulouse, France

Introduction

"TB is among the top 10 causes of death...with the rise of antibiotic resistance making the threat more dangerous."

T. Adhanom Ghebreyesus, Director General of the World Health Organization; United Nation high-Level Meeting on Tuberculosis, Sept. 26th, 2018

Mycobacterium tuberculosis (Mtb)

- The etiologic agent of the human Tuberculosis (TB)
- 1,5 millions of deaths in 2020 (World Health Organization)
- Multi and extensively drug-resistant (MDR and XDR) strains emergence and spread
 - Urgent need for innovative drug development¹

Anti-virulence strategy is a promising approach for innovative therapeutics

- Targets non-essential virulence factor
- Less likely to cause resistance (doesn't affect pathogen's vital metabolic pathways)
- Minimal disruption of beneficial host microbiota unlike conventional antibiotics

Bacterial protein-O-mannosylation process as a new virulence factor of Mtb

MtPMT enzyme initiates *M. tuberculosis* protein-O-mannosylation by transferring a mannose residue from a lipid donor to acceptor protein substrates in the bacterial periplasm.

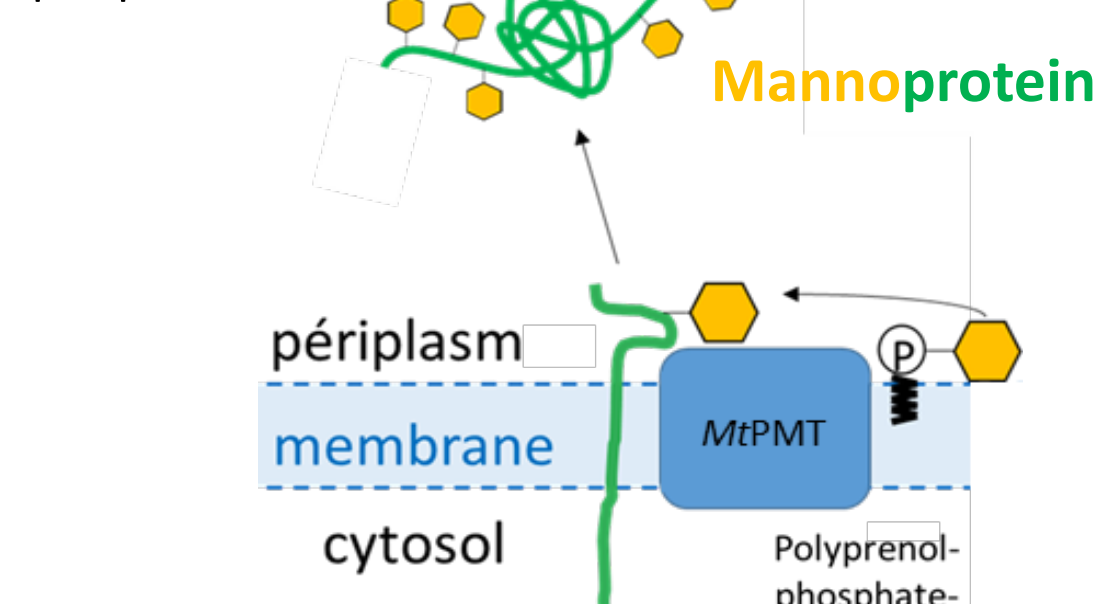

Deletion of MtPMT does not affect *M. tuberculosis* growth *in-vitro* but reduces drastically Mtb infectiousness and virulence in mice by altering the lung intramacrophagic replication (Liu et al.²).

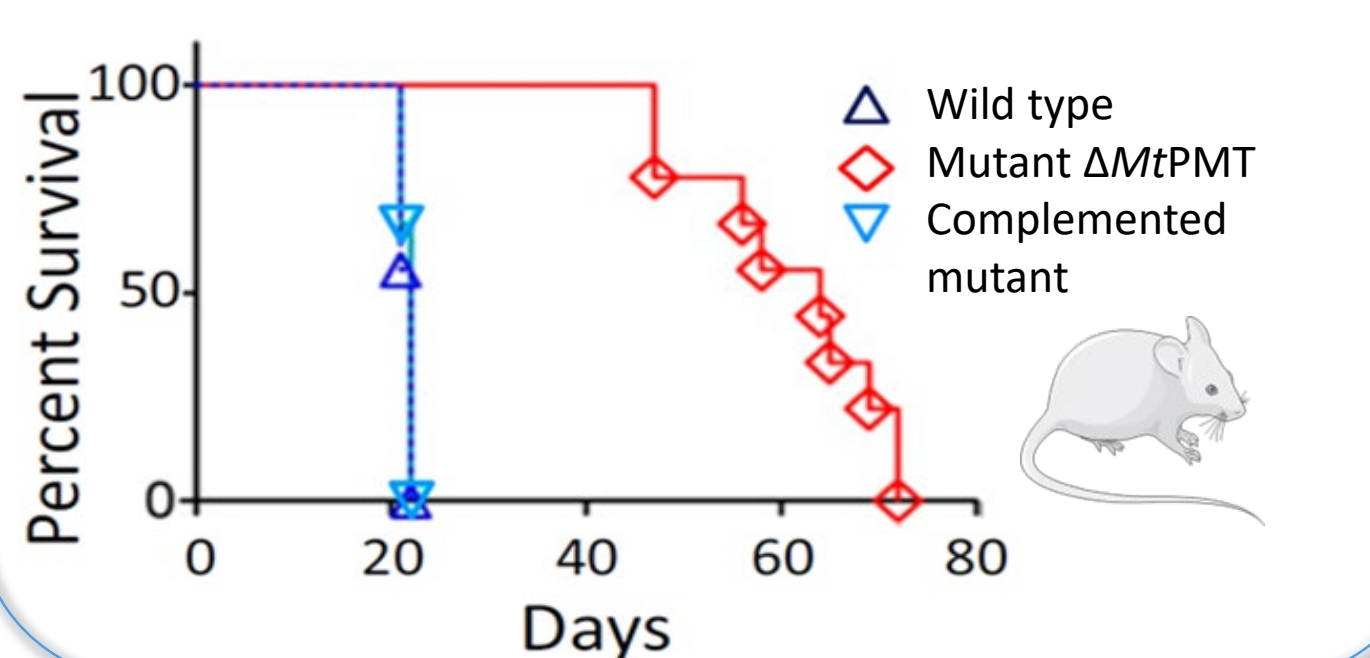

➢ MtPMT : Potential target to fight Tuberculosis

Major advantage: its pleiotropic effect prevents the emergence of drug-resistance³

Aim

Search for specific inhibitors of the *M. tuberculosis* MtPMT with potential therapeutic value (anti-virulence therapy).

Limitations

- MtPMT is an integral membrane protein
- O-Mannosylation process is a co-translocational modification of secreted proteins
- Protein-O-MannosylTransferase (PMT) activity detected in Actinobacteria, yeasts and animals
- Significant sequence homologies between eukaryote and prokaryote PMTs
- Human PMTs are essential (their mutations lead to congenital muscular dystrophies)

Approach

Deciphering of the MtPMT structure-function relationship by mutational analyses to identify specific features distinguishing the MtPMT from the eukaryote PMTs and that could be specifically targeted for *in-vivo* activity inhibition.

Result I: Understanding the molecular mechanism of MtPMT

MtPMT belongs to the C-Type GlycosylTransferase (GT-C) family. Sequence alignments of MtPMT with 6 GT-Cs (including 2 PMTs) with resolved 3D structures^{4,5,6,7,8} enabled the construction of a 3D model. MtPMT is predicted as a large polytopic membrane protein with 11 transmembrane helices (TMH), 5 cytosolic loops and 5 external loops (EL) associated to the mannosyl transferase activity in the periplasm.

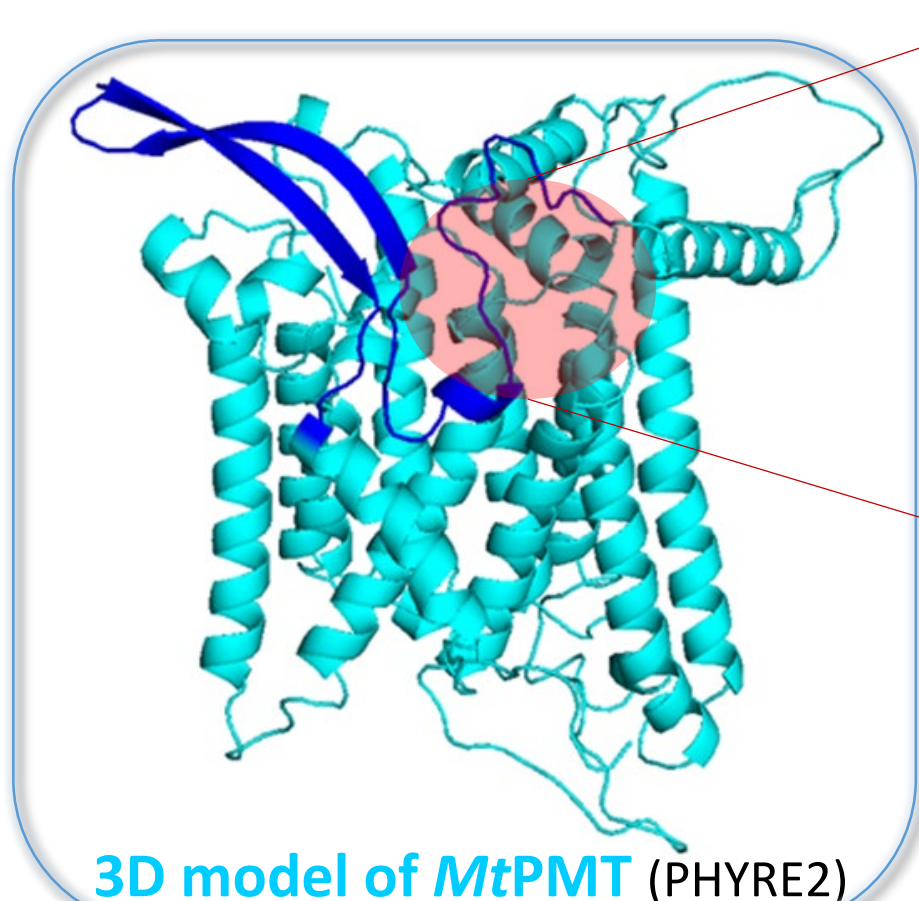
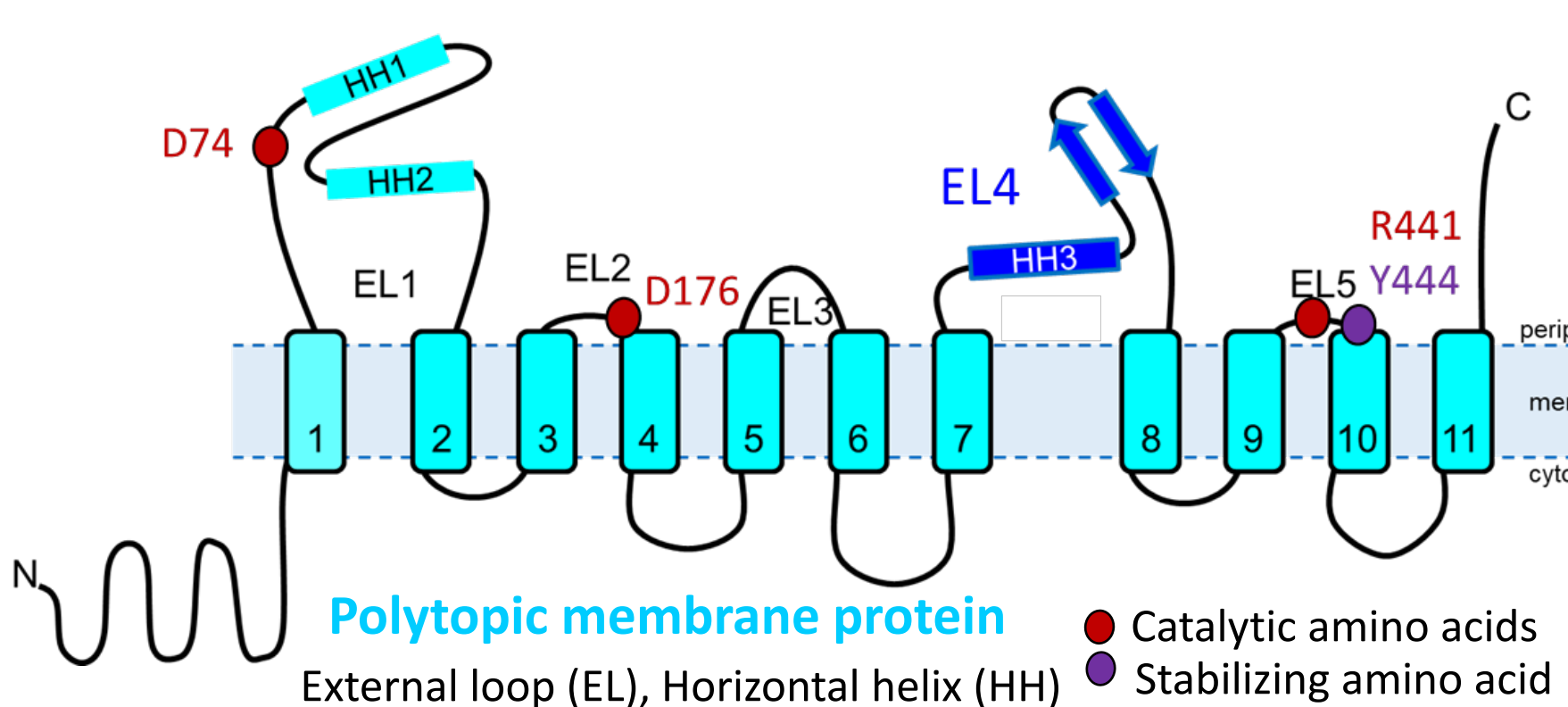

Catalytic triad of MtPMT : D74, D176 and R441

Residues described as catalytic in the GT-Cs are conserved within MtPMT sequence and appear to form a catalytic pocket in the 3D model.

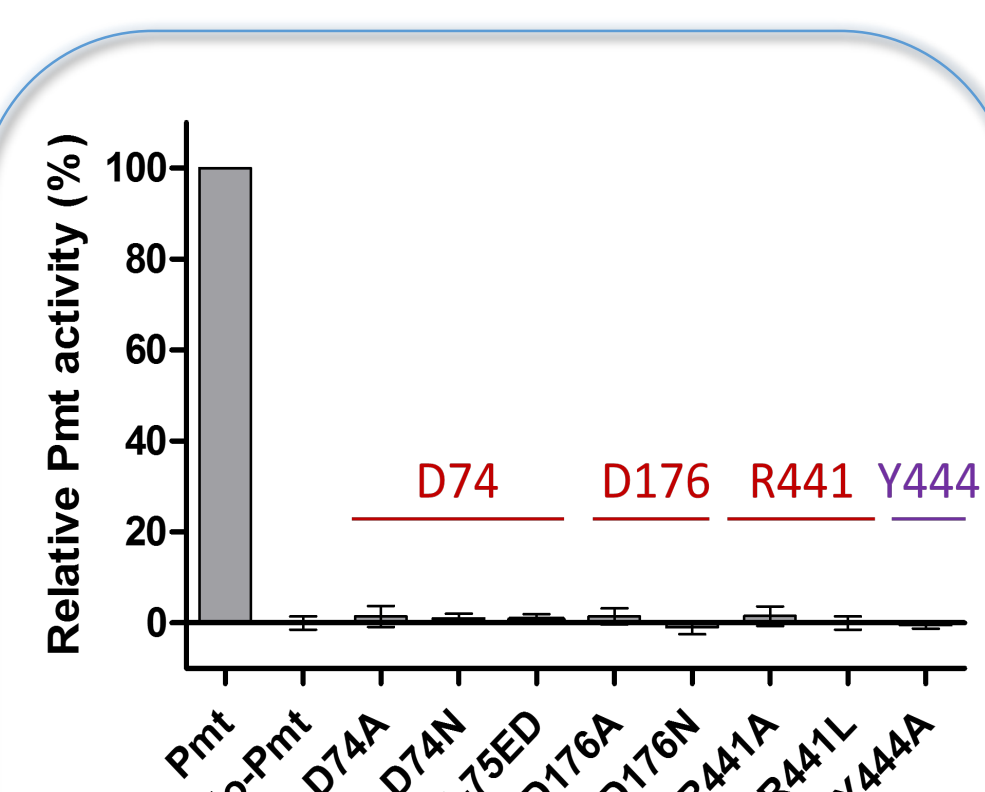

Disruption, by site-directed mutagenesis, of biochemical functions of D74, D176, R441 and Y444 residues prevents totally MtPMT catalysis in bacteria.

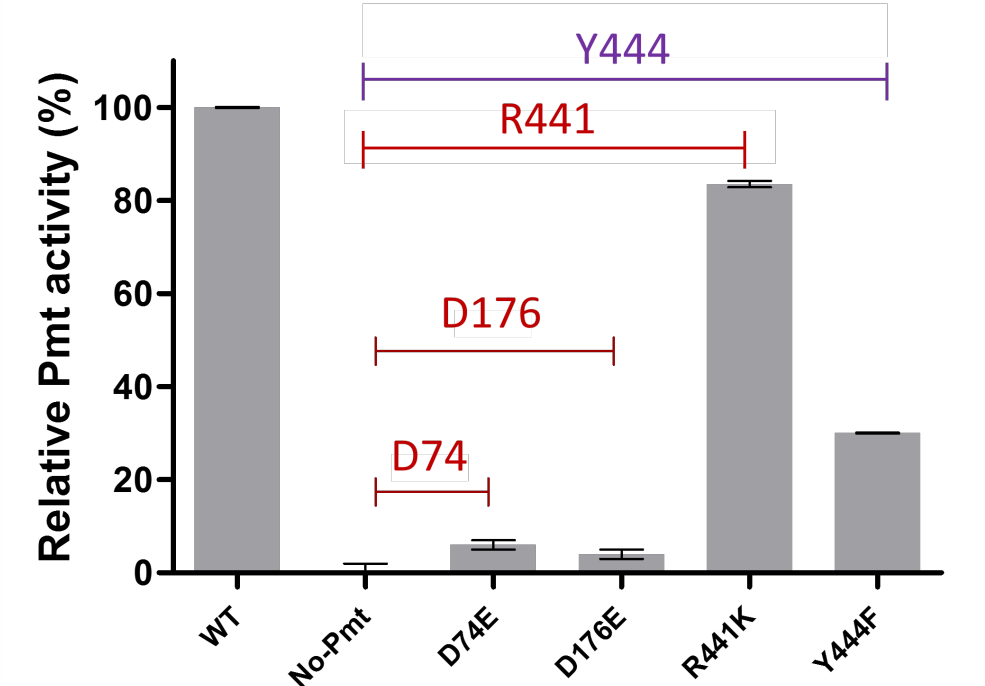

Substitutions by equivalent biochemical functions in mutants D74E, D176E, R441K and Y444F rescue partially the PMT activity.

Result II: Targeted restoration of the O-mannosylation process *in vivo*

Exogenous small chemicals crossing the bacterial periplasm can modulate MtPMT activity *in-vivo*.

Partial chemical rescue of the lack of activity of the MtPMT R441A mutant by treatment of living bacteria with basic exogenous compounds (imidazole or guanidinium) mimicking the missing side chain of arginine.

➢ MtPMT is a druggable target

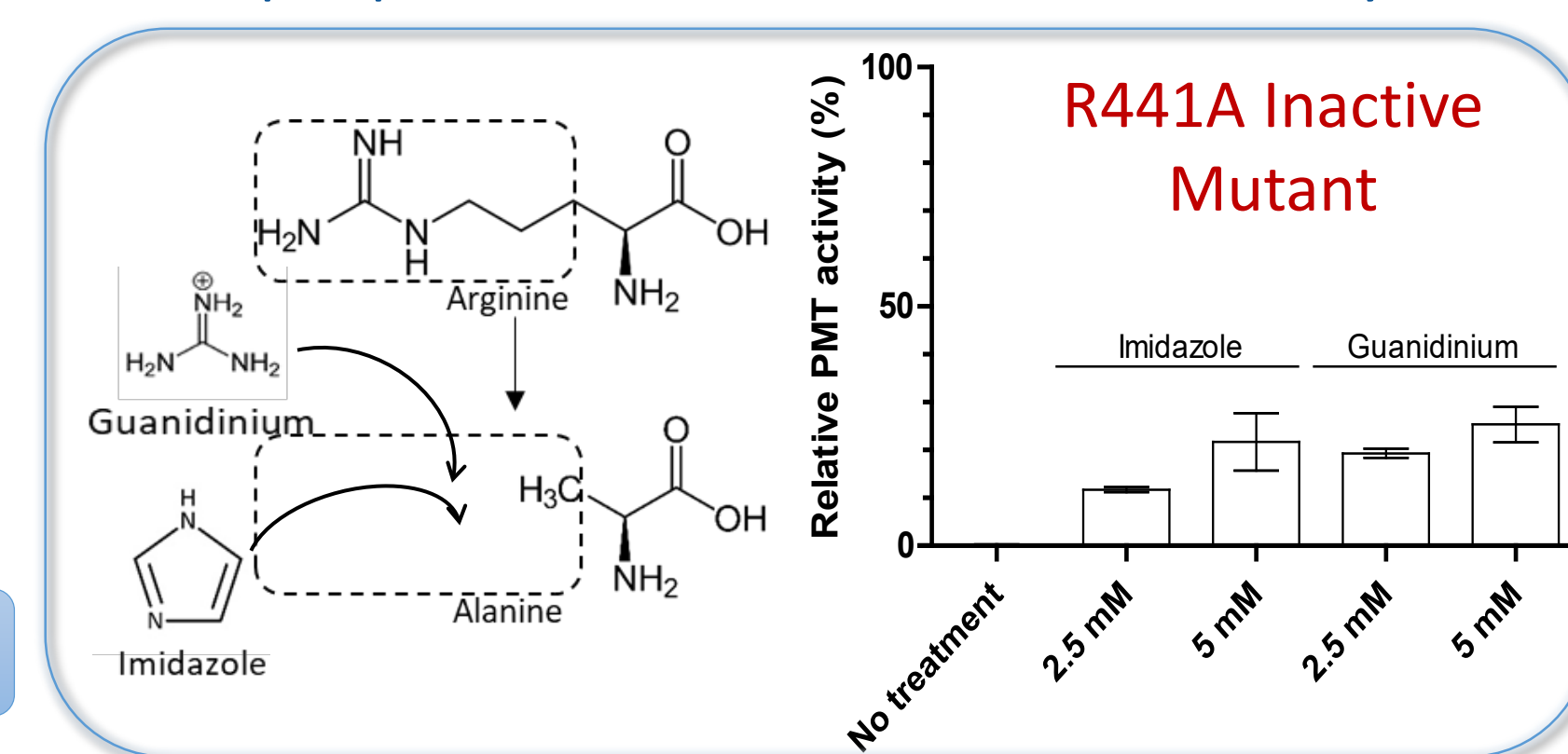

Result III: Search for a specific targetable domain of bacterial MtPMT

In order to identify targetable functional motifs specific to MtPMT, the structural differences with GT-Cs and with eukaryotic PMTs were explored revealing the external loop 4 (EL4) as the most divergent structural domain between bacterial and human PMTs.

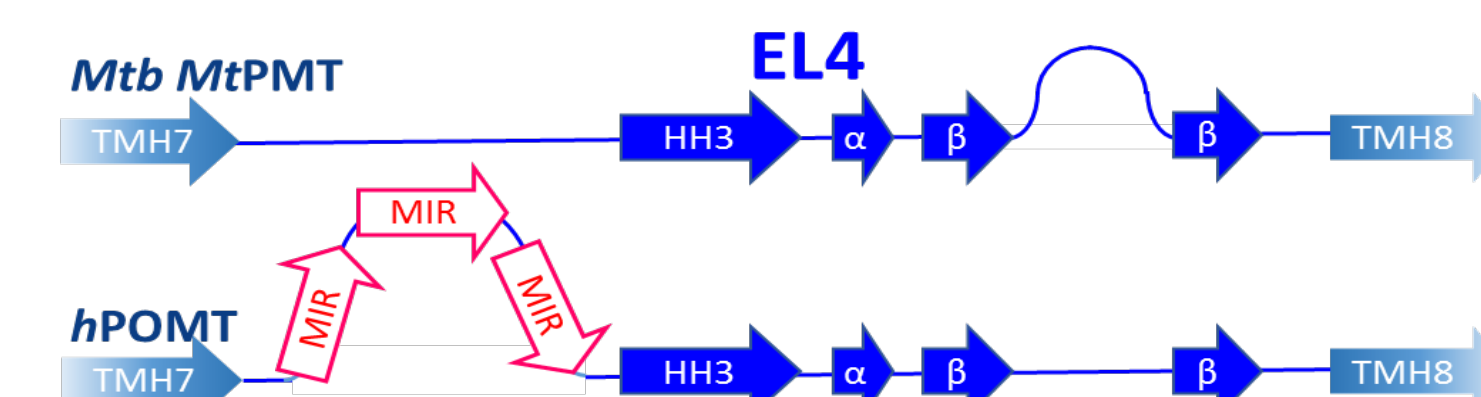

Eukaryote PMT's EL4 has 3 MIR domains⁸, which are absent in MtPMT making the bacterial EL4 shorter than its eucaryotes homologues.

The MtPMT-specific region EL4 shows substantial similarity with protein WW domains involved in protein-protein interactions through recognition of proline-rich peptides^{9,10}, very similar to the O-mannosylation site primary sequences targeted by MtPMT.

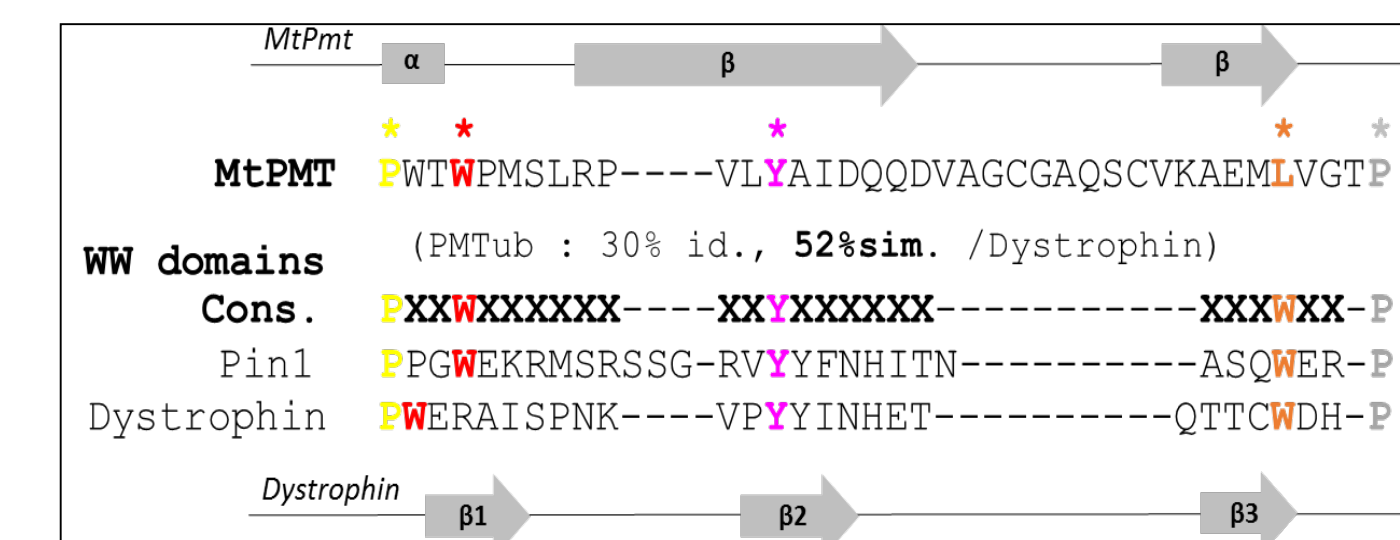

Sequence alignments indicating the consensus amino acids conserved in WW domains and in MtPMT EL4 (colors are reported in the 3D structure).

Evidences of the involvement of EL4 in the enzymatic activity of MtPMT.

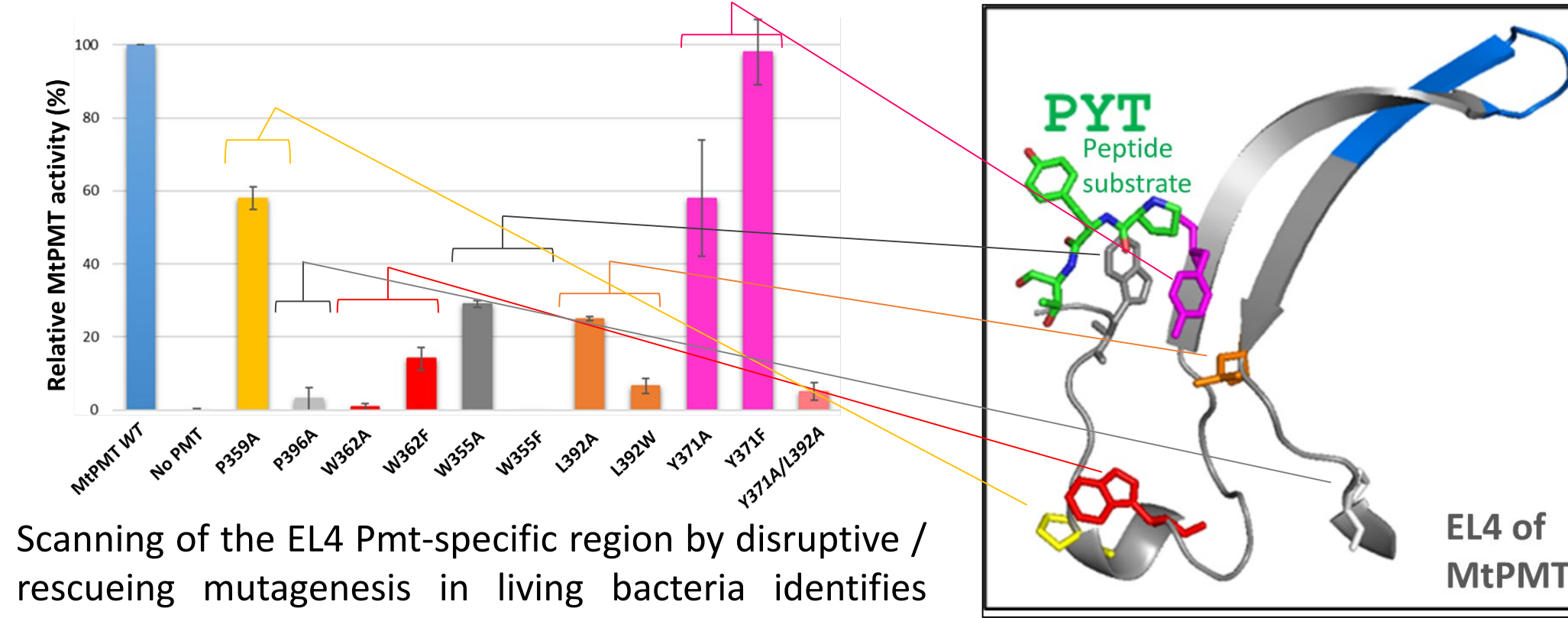

Scanning of the EL4 Pmt-specific region by disruptive / rescuing mutagenesis in living bacteria identifies functional amino acids important for MtPmt activity.

MtPMT EL4 may act as the site of interaction with protein substrates by recognizing glycosylation site proline-rich sequence as do WW domains.

➢ Specific targeting of EL4 protein-protein interactions could constitute a promising approach for selective inhibition of MtPMT activity.

Result IV: *In-vivo* targeting protein O-mannosylation with proline analogues

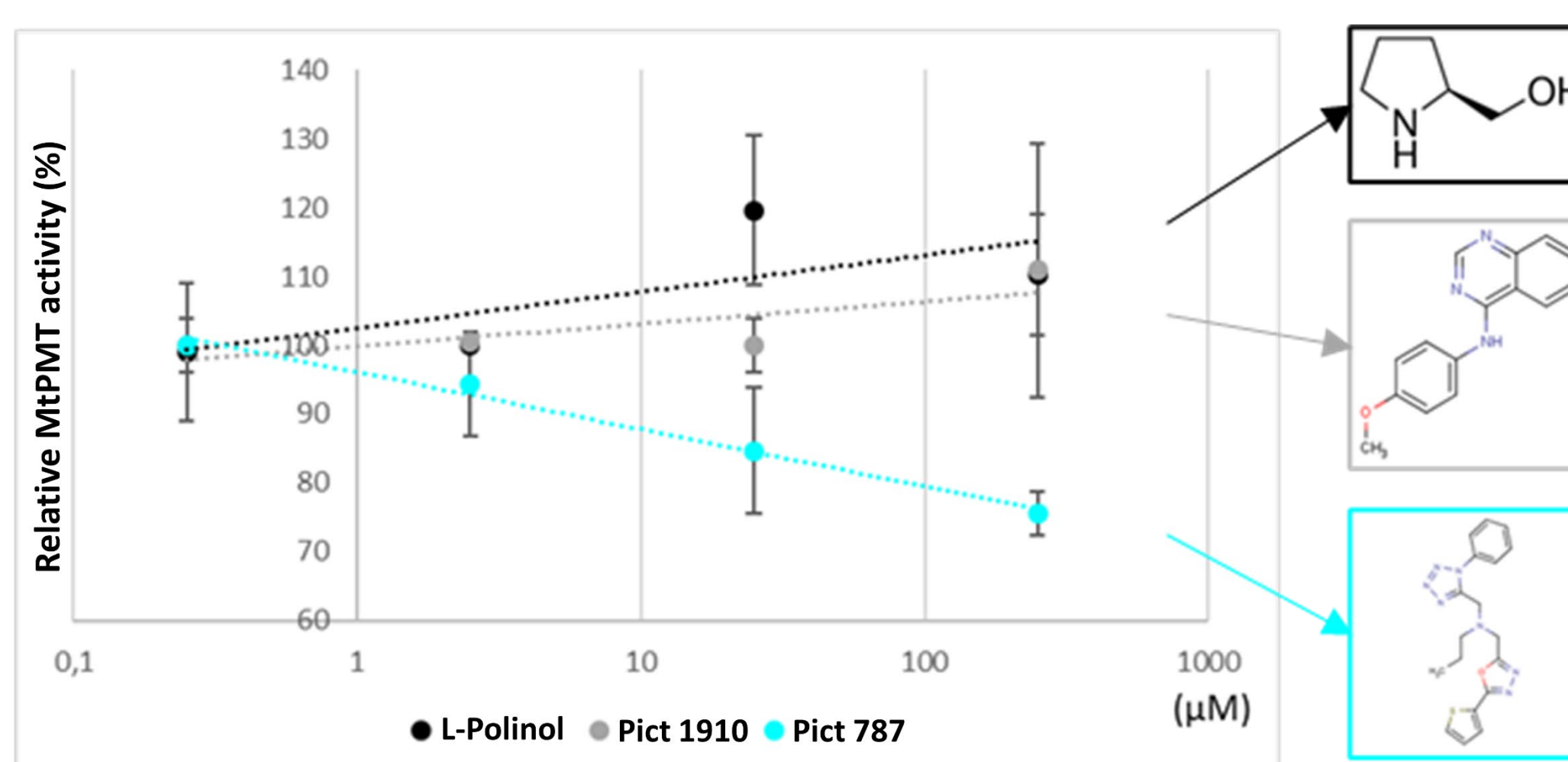

Chemical treatment of living bacteria with the compound Pict787, an analogue of proline-containing peptide, inhibits the WT-MtPMT activity up to 25% with a dose-effect without affecting bacterial growth.

➢ Analogues of proline-containing peptide affect protein O-mannosylation *in vivo*.

Conclusion

Due to the involvement of MtPMT in the virulence of *M. tuberculosis*, this enzyme constitutes a potential target for a future anti-virulence drug offering a new therapeutic way to fight against TB. Beyond TB, PMTs are implicated in the virulence of various pathogens and specific inhibition of MtPMT would provide a proof of concept for targeting PMTs in various pathologies.

Prospects

- Conformational analysis in solution of EL4 isolated domain : WW domains are autonomous modules able to interact with their substrates when isolated products in solution¹⁰. We will explore whether the primary sequence homology of MtPMT EL4 with WW domains induces similar behavior.
- This will open a new route for *in vitro* interaction studies between the isolated EL4 domain and a peptide substrate to demonstrate the role of this domain and its binding specificity to proline-rich substrates.

