



HAL
open science

A Composing Program for a Portable Sound Synthesis System

Marc Battier

► **To cite this version:**

Marc Battier. A Composing Program for a Portable Sound Synthesis System. *Computer Music Journal*, 1979, 3 (3), pp.50-53. hal-03950693

HAL Id: hal-03950693

<https://cnrs.hal.science/hal-03950693v1>

Submitted on 22 Jan 2023

HAL is a multi-disciplinary open access archive for the deposit and dissemination of scientific research documents, whether they are published or not. The documents may come from teaching and research institutions in France or abroad, or from public or private research centers.

L'archive ouverte pluridisciplinaire **HAL**, est destinée au dépôt et à la diffusion de documents scientifiques de niveau recherche, publiés ou non, émanant des établissements d'enseignement et de recherche français ou étrangers, des laboratoires publics ou privés.

A Composing Program for a Portable Sound Synthesis System

Marc Battier
Groupe Art et Informatique Vincennes
Université Paris VIII
Route de la Tourelle
75571 Paris, France

Introduction

The ICOSA program is an attempt at an interactive musical system, referring to well-known models in electro-acoustic music. The main musical idea of the project can be summed up as the *generation of a heterophony* which develops a dynamic profile by means of varying frequency patterns.

For the reader who is unfamiliar with the relevant equipment, I will mention some of the characteristics of the devices used as well as the organization of the sound synthesis instrument.

Hybrid Synthesis

The Groupe Art et Informatique Vincennes (G.A.I.V.) has a system of hybrid music synthesis which is organized around a microcomputer. The musician uses a programming language written by Patrick Greussay (INTELGREU) and different peripherals, including the inevitable computer terminal, a digital-to-analog conversion device (DAC), and an analog sound synthesizer. The DAC device used in this project is comprised of eight converters, designed to deliver an analog voltage in exchange for binary information from the micro-

computer. It is this voltage, which is the analog image of the numbers produced by the computer program, that controls the devices of the synthesizer. It is obvious that the organization of the programming depends on the instrument of sound synthesis that one wants to use.

Description of the Instrument

The synthesizer being used has several devices which facilitate the dynamic formation of an audio signal. We selected the most appropriate ones for our project. Among these devices, there is one specifically designed for this use – the envelope shaper. This term actually designates two distinct elements: a Voltage Controlled Amplifier (VCA), and the control-voltage generator itself, the trapezoid generator. With this apparatus we get a variety of envelopes. However, the shape of the trapezoid itself is not voltage-controlled; an externally-supplied voltage affects only one part of its period. It cannot be controlled by the computer, since its cycle is internally programmed. Nonetheless, it will allow us to define events of a simple amplitude envelope. (see Figure 2)

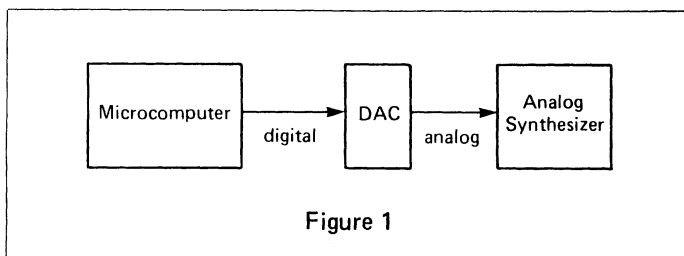

Figure 1

This paper originally appeared in French in ART-INFO-MUS-INFO No. 27 (1977), University of Paris VIII-Vincennes. This English version was translated by Hannah-Leigh Bull. Translation © 1979 H.-L. Bull.

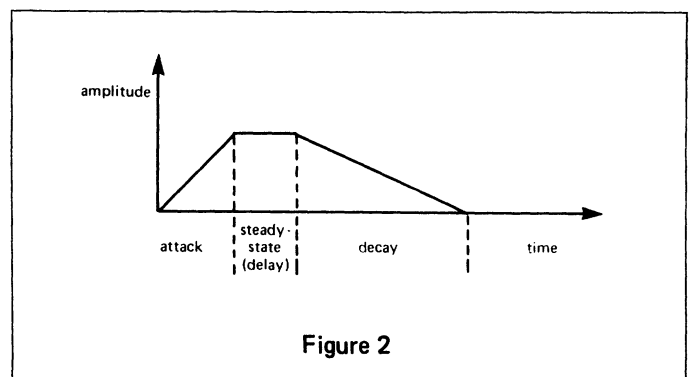

Figure 2

A second device offers greater flexibility: the output amplifier of the synthesizer. It is a VCA but here the control voltage will come directly from the DAC. The gain of the VCA increases according to the amplitude of the control signal: by applying gradual voltage to it, we get a growing amplitude envelope. The program will create percussion-resonance type envelopes.

The low-pass filter can also vary the envelope of the sound. A shift in the filter's cutoff frequency from a low frequency to a high frequency and back to a low frequency over the duration of a sound produces a crescendo-decrescendo effect; there is actually an appearance and disappearance of energy. However, the dynamic action is selective. The ear will sometimes be able to perceive a change in timbre, and at other times, a dynamic variation. The two phenomena are still connected, with the first tending to mask the second. The dynamic effect struggles with the changes in timbre, depending on whether the accent is placed on the shift in cross-over frequency, its position in relation to the register of the spectrum, etc.

Dynamic Control by the Computer

In order to produce the sound material of the piece, the program had to specify two elements: the frequency of the selected oscillator and the dynamic variation of the VCA or the filter. One DAC will be responsible for the frequency control, and another for the control of the VCA. (See Figure 3)

Each emerging envelope will reveal a sound object possessing a new frequency. The program has to coordinate the search for a frequency and the calculation of an envelope.

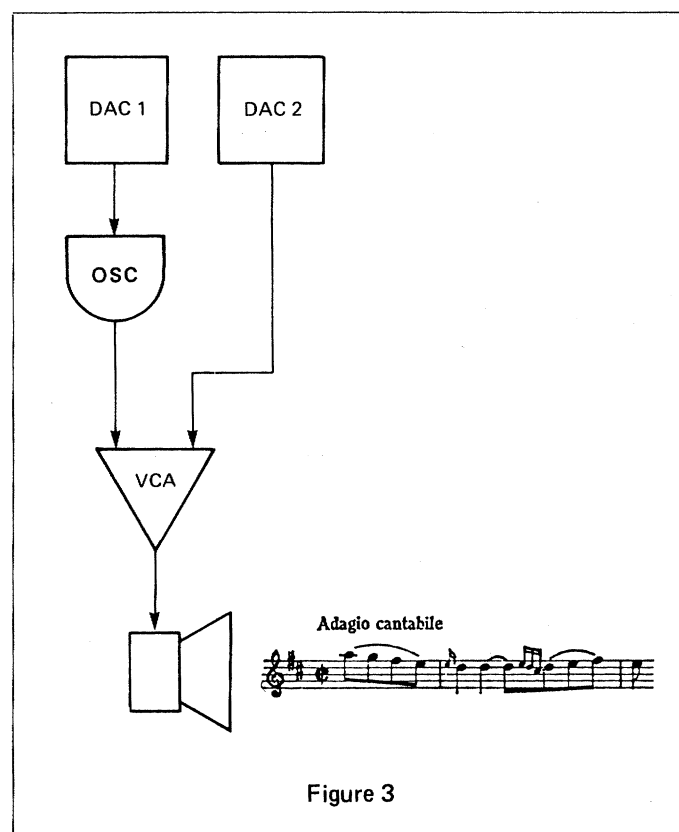
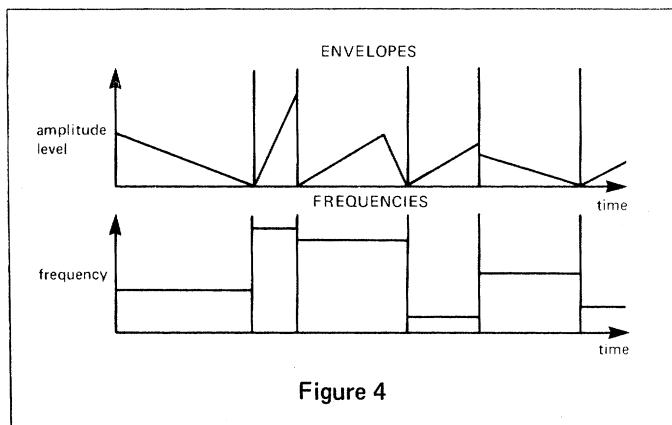

Figure 4 specifies a possible sequence. The upper diagram shows the series of envelopes, and the lower one, the series of frequencies. A search for a new frequency corresponds with each amplitude decay.



More precisely, the program will have to determine three parameters at each new cycle:

- (1) the frequency of the formulated signal
- (2) the maximum value of the envelope
- (3) the duration of the envelope

The Dynamic Algorithm

In order to develop a variety of amplitude envelopes beyond the simple ramp, the envelope will be divided into two events: the attack (to a maximum), and the decay (from a new maximum to a complete termination). This produces a wider potential richness of envelopes, as shown in Figure 5.

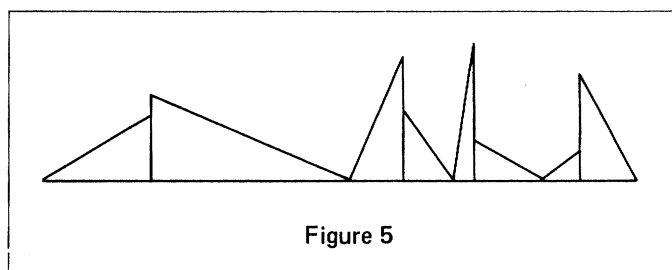

Subroutine IN. V

The IN. V subroutine is responsible for calculating the attack (incrementing) part of the envelope, which is represented by the identifier V_{var} , designating variation of the VCA. V_{var} takes values from zero (a closed amplifier) up to a maximum random value V_{max} . Each new V_{var} value represents the instantaneous value of the envelope. When the incrementing (attack portion of the envelope) reaches V_{max} , the DC. V program intervenes by decrementing V_{var} from V_{max} to zero. At each step, a value is transferred to the DAC. At the end of the cycle, the program generates a new random frequency FRV or the FR equency of the oscillator passed by the VCA. Finally the total duration of the envelope is modified by a delay loop which is scanned at each step of the incrementing or decrementing.

The Program Sequence

The following four steps represent the program sequence, at least at this elementary stage:

- (1) Calling Program test if the envelope attacks (call IN.V) or decays (call DC.V)
- (2) Subroutine FR.V random FRV (frequency) output to the DAC
- (3) Subroutine IN.V increment V_{var} ;
if $V_{var} \neq V_{max}$ then RETURN (the attack is not finished)
ELSE
 - calculate a new duration, *i.e.*, the coefficient of the delay loop
 - fetch the maximum random value to attain (V_{max})
 - V_{var} is set to zero
 - RETURN
- (4) Subroutine DC.V decrement V_{var} ;
if $V_{var} \neq$ zero then RETURN (the decay is not finished)
ELSE
 - calculate a new duration
 - fetch the V_{max} random value
 - fetch the new random value of FRV (new output frequency)
 - RETURN

You will notice that the example deals with only one dynamic device, the VCA. Actually the program uses a second one—the low-pass filter of the synthesizer mentioned above. Its formal evolution is similar to the VCA, but it is controlled differently; the filter's cutoff frequency, the filtration point of the spectrum, does not rise but lowers when the voltage increases. Like a VCO, it varies inversely with the control voltage. Therefore, our envelope image will have to be inverted to obtain the desired effect. For the cutoff frequency to follow the model of envelope curve, we will first have to transfer a decaying high voltage which then attacks again.

The identifier F_{var} is initialized at the maximum possible value F_{top} and then decremented in the DC.F subprogram to the random value F_{max} . At this threshold value, the principal program calls the subroutine IN.F. F_{var} takes a new random value and proceeds to F_{top} . With the cycle terminated, a new frequency FRF is generated. Figure 6 shows the opposite shapes of our two envelopes.

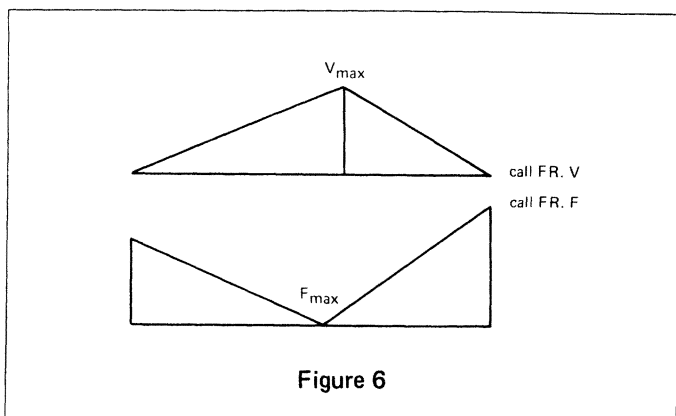

Figure 6

The Randomizing Subroutine

This subroutine uses Patrick Greussay's pseudorandom number generator algorithm. The random numbers are distributed among many parameters; there is no possibility of revealing the unwanted presence of the pseudorandom series during the performance of the piece.

Supervision by the Principal Program

Let us end this overall description by mentioning the synchronization between the subprograms. Remember that subprograms IN.V and DC.V on one hand, and DC.F and IN.F on the other calculate the values of V_{var} and F_{var} respectively, representing the instantaneous state of the dynamic evolution of the sound. To generate two independent voices, each complying with its own constraints, it is necessary to synchronize all the variables. The idea involves the calculation of the current value of V_{var} , its output on the DAC, then the calculation of the current value of F_{var} , its output, and so on; it is assured by two monitors: V_1 and F_1 .

MONITOR V_1

- test if the current subroutine is IN.V or DC.V
- load the accumulator with the current value of V_{var}
- call the output subroutine OUT
- call subroutine IN.V or DC.V;
(the current subroutine will then have to increment or decrement V_{var} by one)
- jump to monitor F_1

The monitor routine F_1 performs the same function for F_{var} .

Organization of the Voices

The ICOSA program is designed for two independent synthesizers, or four voices:

- Synthesizer 1: voice one – oscillator/VCA₁
 voice two – oscillator/filter₁
- Synthesizer 2: voice one – oscillator/VCA₂
 voice two – oscillator/filter₂

The order of the output sequences is as follows:

- Monitor V_1 – output V_{var} on voice one (IN.V or DC.V)
Monitor F_1 – output F_{var} on voice two (DC.F or IN.F)
Monitor V_2 – output V_{var} on voice three (IN.V or DC.V)
Monitor F_2 – output F_{var} on voice four (DF.F or IN.F)

The calling of the subroutines depends on a binary variable AIG which is set to one for incrementation and otherwise zero. Each time a threshold is reached, (*e.g.*, $V_{var} = V_{max}$) AIG is reversed.

Tempi and Regions of Heterophony

If we produced above only the means for a melodic polyphony, we can additionally combine it with a polyphony of tempi, which is also formed from various envelope combinations. Subroutine REGTEM is responsible for managing

the determining parameters of the heterophony. The range of the durations of all the half-envelope ramps is divided into four regions:

- REG 0 – short durations
- REG 1 – short to medium
- REG 2 – medium to long
- REG 3 – long

Each region constitutes a range of durations whose current value *TEM* is furnished to the delay loop (described in **Subroutine IN.V** above). Values for REG 0 and REG 1 come from filtered random numbers; those for REG 2 and REG 3 are supplied by the performer at the microcomputer's keyboard.

Realization of RE COSA MATERIALE

RE COSA MATERIALE, the version of the ICOSA program for live electronic music, uses two synthesizers, the VCS-3 and EMS, and a digital-to-analog conversion system 8-DAC built by Christian Colere. Figure 7 shows the distribution of the DACs. A device constructed by Didier Roncin smooths pulses which occur during very short envelopes (with intense attack transitions) on lines 04 and 40 (to the VCA's).

DAC Address	08	04	02	01
Device Address	Filter 1	VCA 1	FRF 1	FRV 1
DAC Address	80	40	20	10
Device Address	Filter 2	VCA 2	FRF 2	FRV 2

Figure 7

Figure 8 shows a diagram of the instrument. It is not my concern here to present a score, whose form depends on the choices of the performer/composer, but rather I will make a few remarks taken from prior realizations.

The interactive performance situation permits an equilibrium between the choices of the performer and the variations of the program. The system allows the performer to modify his interaction by means of the synthesizer controls and the potentiometer controls on the 8-DAC device itself.

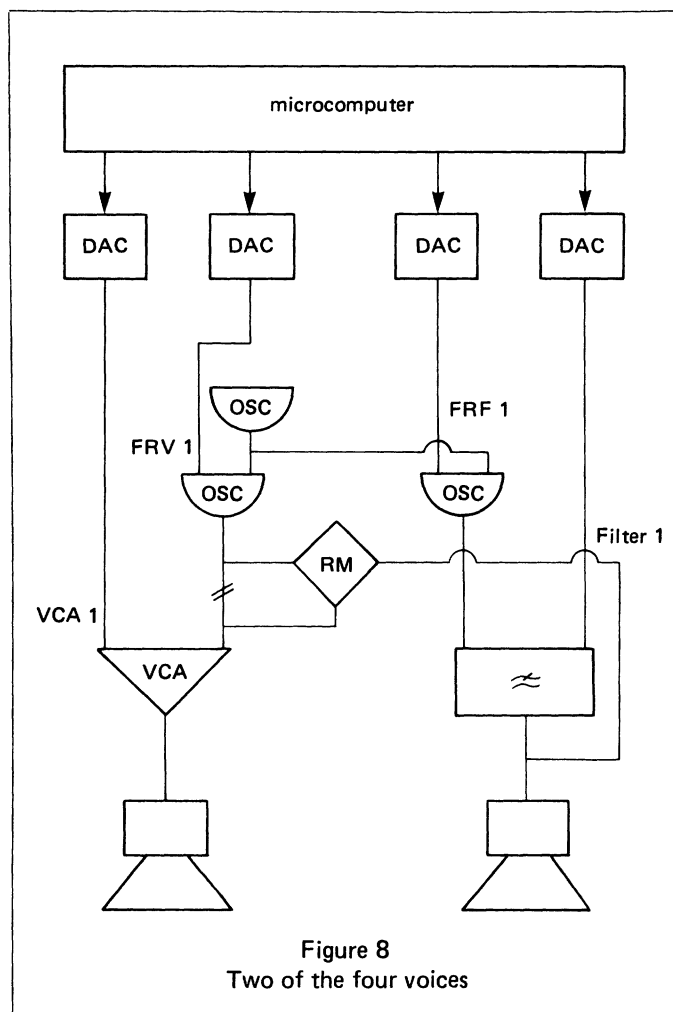

Figure 8
Two of the four voices

Variations of the control-voltage levels change many frequency-controlling circuits. The filter is especially amenable to these variations; also, the oscillators can be shifted from a low extreme to a high extreme. Thus, the performer can modify the frequency of the oscillators, the degree of resonance in the filters, and the amount of reverberation.

One final note: one of the first versions of the ICOSA program was broadcast as environmental music during an exposition of the painter RICO in Créteil, February 1977. The live version was presented in Frankfurt and Zurich, April 1977. The recorded version, mixed in the electroacoustic studio of the Music Department at Vincennes, was played at the Experimental Music Festival in Bourges, May 1977.