



HAL
open science

The IgH E μ -MAR regions promote UNG-dependent error-prone repair to optimize somatic hypermutation

Ophélie A Martin, Morgane Thomas, Marie Marquet, Charlotte Bruzeau, Armand Garot, Mylène Brousse, Sébastien Bender, Claire Carrion, Jee Eun Choi, Bao Q Vuong, et al.

► To cite this version:

Ophélie A Martin, Morgane Thomas, Marie Marquet, Charlotte Bruzeau, Armand Garot, et al.. The IgH E μ -MAR regions promote UNG-dependent error-prone repair to optimize somatic hypermutation. *Frontiers in Immunology*, 2023, 14, pp.1030813. 10.3389/fimmu.2023.1030813 . hal-04001732

HAL Id: hal-04001732

<https://cnrs.hal.science/hal-04001732v1>

Submitted on 23 Feb 2023

HAL is a multi-disciplinary open access archive for the deposit and dissemination of scientific research documents, whether they are published or not. The documents may come from teaching and research institutions in France or abroad, or from public or private research centers.

L'archive ouverte pluridisciplinaire **HAL**, est destinée au dépôt et à la diffusion de documents scientifiques de niveau recherche, publiés ou non, émanant des établissements d'enseignement et de recherche français ou étrangers, des laboratoires publics ou privés.



Distributed under a Creative Commons Attribution 4.0 International License



OPEN ACCESS

EDITED BY

Paolo Casali,
The University of Texas Health Science
Center at San Antonio, United States

REVIEWED BY

Uttiya Basu,
Columbia University, United States
Jayanta Chaudhuri,
Memorial Sloan Kettering Cancer Center,
United States
Frederick Alt,
Harvard Medical School, United States

*CORRESPONDENCE

Eric Pinaud

✉ eric.pinaud@unilim.fr

Sandrine Le Noir

✉ sandrine.le-noir@unilim.fr

†PRESENT ADDRESS

Ophélie A. Martin,
Genome Damage and Stability Centre,
School of Life Sciences, University of
Sussex, Brighton, United Kingdom

†These authors have contributed equally to
this work

SPECIALTY SECTION

This article was submitted to
B Cell Biology,
a section of the journal
Frontiers in Immunology

RECEIVED 29 August 2022

ACCEPTED 13 January 2023

PUBLISHED 14 February 2023

CITATION

Martin OA, Thomas M, Marquet M,
Bruzeau C, Garot A, Brousse M, Bender S,
Carrion C, Choi JE, Vuong BQ,
Gearhart PJ, Maul RW, Le Noir S and
Pinaud E (2023) The IgH $E\mu$ -MAR regions
promote UNG-dependent error-prone
repair to optimize somatic hypermutation.
Front. Immunol. 14:1030813.
doi: 10.3389/fimmu.2023.1030813

COPYRIGHT

© 2023 Martin, Thomas, Marquet, Bruzeau,
Garot, Brousse, Bender, Carrion, Choi,
Vuong, Gearhart, Maul, Le Noir and Pinaud.
This is an open-access article distributed
under the terms of the [Creative Commons
Attribution License \(CC BY\)](https://creativecommons.org/licenses/by/4.0/). The use,
distribution or reproduction in other
forums is permitted, provided the original
author(s) and the copyright owner(s) are
credited and that the original publication in
this journal is cited, in accordance with
accepted academic practice. No use,
distribution or reproduction is permitted
which does not comply with these terms.

The IgH $E\mu$ -MAR regions promote UNG-dependent error-prone repair to optimize somatic hypermutation

Ophélie A. Martin^{1†}, Morgane Thomas^{1†}, Marie Marquet^{1†},
Charlotte Bruzeau¹, Armand Garot¹, Mylène Brousse¹,
Sébastien Bender^{1,2}, Claire Carrion¹, Jee Eun Choi³,
Bao Q. Vuong³, Patricia J. Gearhart⁴, Robert W. Maul⁴,
Sandrine Le Noir^{1*} and Eric Pinaud^{1*}

¹Laboratoire Contrôle de la Réponse Immune B et des Lymphoproliférations (CRIBL), Université de Limoges, CNRS Unité Mixte de Recherche 7276, Inserm Unité 1262, Limoges, France, ²Centre Hospitalier Universitaire Dupuytren, Service d'Immunopathologie, Limoges, France, ³The Graduate Center, The City University of New York, New York, NY, United States, ⁴Laboratory of Molecular Biology and Immunology, National Institute on Aging, National Institutes of Health, Baltimore, MD, United States

Introduction: Two scaffold/matrix attachment regions (5'- and 3'- $MAR_{E\mu}$) flank the intronic core enhancer ($cE\mu$) within the immunoglobulin heavy chain locus (IgH). Besides their conservation in mice and humans, the physiological role of $MAR_{E\mu}$ is still unclear and their involvement in somatic hypermutation (SHM) has never been deeply evaluated.

Methods: Our study analyzed SHM and its transcriptional control in a mouse model devoid of $MAR_{E\mu}$, further combined to relevant models deficient for base excision repair and mismatch repair.

Results: We observed an inverted substitution pattern in of $MAR_{E\mu}$ -deficient animals: SHM being decreased upstream from $cE\mu$ and increased downstream of it. Strikingly, the SHM defect induced by $MAR_{E\mu}$ -deletion was accompanied by an increase of sense transcription of the IgH V region, excluding a direct transcription-coupled effect. Interestingly, by breeding to DNA repair-deficient backgrounds, we showed that the SHM defect, observed upstream from $cE\mu$ in this model, was not due to a decrease in AID deamination but rather the consequence of a defect in base excision repair-associated unfaithful repair process.

Discussion: Our study pointed out an unexpected "fence" function of $MAR_{E\mu}$ regions in limiting the error-prone repair machinery to the variable region of Ig gene loci.

KEYWORDS

B cell, immunoglobulin gene, MARs region, somatic hypermutation (SHM), UNG

Introduction

The *IgH* locus, encoding the immunoglobulin heavy chain, is among the most complex in mammals, with multiple *cis*-regulatory elements controlling stepwise DNA accessibility to recombination and mutation through mechanisms that mainly rely on transcription (1). Current studies of the dynamic processes that regulate chromatin conformation changes and subnuclear location have renewed interest in *cis*-regulatory regions that delimit differentially regulated chromosomal domains. Among such DNA regulatory regions, nuclear Scaffold/Matrix Attachment Regions (MARs) have been implicated in the structural and functional organization of these domains. The juxtaposition of MARs to intronic enhancer elements in both *IgH* and *IgL* loci and their conservation in humans, mice and rabbits (2) suggest that such regions serve physiological functions. They participate in the regulation of gene expression notably by increasing enhancer function and facilitating their action over large distances. Several proteins found to bind MARs are expressed ubiquitously or in a tissue-specific manner, respectively defining constitutive or facultative MARs (3). Once attached to the nuclear matrix in a tissue specific fashion, facultative MARs could form topological barriers that could isolate or fasten chromatin regions (3). Such barriers could induce DNA torsional strain with positive and negative DNA supercoiling, respectively, upstream and downstream from the RNA pol II-induced transcription bubble (4). The supercoils are then released by the action of dedicated topoisomerases (5).

The *IgH E μ* enhancer region is a combination of both the core *E μ* (*cE μ*) enhancer element (220 bp) and two 310–350-bp flanking MARs (*MARs_{E μ}*) that were first defined by *in vitro* matrix-binding assays (6). This region, especially *cE μ* , controls early VDJ recombination events (7, 8) and is also involved in Ig μ chain expression in pre-B cells (9). However, its role in SHM remains unclear. An elegant model of deletion in the endogenous *E μ* region of hybridoma cells, enforced for human AID expression, suggested the requirement of *cE μ* and a substantial function of *MARs_{E μ}* for SHM (10). Similarly, when added to transgenes, *cE μ* and its flanking MARs contribute to Ig μ chain expression and high levels of SHM (11–16). In contrast, knock out (KO) models underlined the complexity of its physiological regulation. In a mouse model carrying the pre-rearranged VB1-8i region, *E μ* deletion still resulted in a high level of SHM in Peyer's patch germinal center (GC) B cells, arguing for a non-essential role of the enhancer (17). More clearly, deletion of *cE μ* in the mouse germline did not reduce SHM frequency but only slightly increased the proportion of unmutated alleles; this minor effect was likely due to the reduced inflow of peripheral and, consequently, GC B cells in this model (7). Strikingly, the role of *MARs_{E μ}* was also elusive and somewhat controversial. Whereas their endogenous deletion, analysed in mouse chimeras by the RAG-2 complementation assay, demonstrated that *MARs_{E μ}* are dispensable for VDJ recombination and IgH expression (18), the ambiguous function of *MARs_{E μ}* was sustained by the discrepancy between their ability to either bind negative regulatory factors (19, 20), improve *cE μ* enhancer efficiency (21), or substitute for *cE μ* to maintain IgH expression (22). At the κ light chain locus (*Ig κ*), the intronic enhancer *Ei κ* region also contains an upstream MAR. The implication of *MAR_{Ei κ}* as an enhancer of SHM was first suggested in transgenic studies (23) and then tested in a

KO mouse model that accumulated premature light chain rearrangements with a mild SHM defect (24), an effect comparable to one observed at *IgH* locus in hybridoma cells devoid of *MARs_{E μ}* (10). At that time, while these studies instigated a variety of hypotheses accounting for MARs in modulating SHM (25), these were contradicted by a study comparing 3'*E κ* - and *MAR_{Ei κ}* - function in mouse KO models (26).

To address the controversy over the role of the scaffold in SHM, we generated a mouse model carrying a germline deletion of *MARs_{E μ}* and bred it into DNA repair-deficient backgrounds. In our models devoid of *MARs_{E μ}* and their *wt* counterparts, we proceeded to side by side comparison of total SHM, transcription patterns, AID targeting and error prone repair events leading to SHM, in regions located upstream and downstream from the intronic enhancer. Our study showed that the absence of *MARs_{E μ}* allows some of the error-prone repair machinery to get access to the region downstream from the *E μ* enhancer. We propose that *MARs_{E μ}* act as physiological barriers for error-prone repair in activated B cells. As a rational hypothesis, our study suggests that the conservation of nuclear matrix attachment regions in Ig genes serves to optimize SHM events upstream from the intronic enhancer region.

Results

Normal B cell development and Ig production in the absence of *MARs_{E μ}*

We generated a mouse mutant line carrying an endogenous deletion of both the 5' and 3' *IgH* matrix attachment regions that flank the *J_H-C_H* intronic *cE μ* enhancer. Although generated with slightly different targeting vector backbone and homology arms, the resulting *IgH* allele, so-called *MARs_{E μ} ^Δ* (Figure 1A), is similar to that generated by Sakai et al. (18). Bone marrow subsets of B cell precursors were analysed in *wt* and homozygous *MARs_{E μ} ^{Δ/Δ}* deficient mice. When compared to age-matched *wt* animals, *MARs_{E μ} ^{Δ/Δ}* mice exhibited normal proportions and numbers of pre-proB, pro-B and pre-B cell precursors (Supplementary Table 1). Unlike endogenous deletion of the entire *E μ* region (9), *MARs_{E μ}* deletion did not modify Ig μ heavy chain expression in early B lineage cells since proportions of IgM-expressing bone marrow B cell populations (immature, transitional and mature recirculating B cell subsets) were comparable to those of *wt* (Supplementary Table S1 and Supplementary Figure S1A). Mature B cell subsets were also similar to *wt* in the spleen and peritoneal cavity of homozygous *MARs_{E μ} ^{Δ/Δ}* mutants (Supplementary Table S1 and Supplementary Figures S1B, C). In agreement with the normal inflow of mature B cells in *MARs_{E μ} ^{Δ/Δ}* animals, Peyer's patches were efficiently colonized by naive and GC B cells. Numbers and proportions of GC B cells were even significantly increased in homozygous mutants (Figure 1B left panels and Supplementary Table S1). The similar proportion of proliferating KI67⁺ GC B cells in *wt* and *MARs_{E μ} ^{Δ/Δ}* mice implied that this increase was not due to over-proliferation of Peyer's patch B cells (Figure 1B right panels). Finally, levels of serum Ig isotypes were unaffected in *MARs_{E μ} ^{Δ/Δ}* animals (Figure 1C). This normal B cell homeostasis in homozygous mutants confirmed that *MARs_{E μ}* are dispensable for B cell ontogeny and antibody production. This

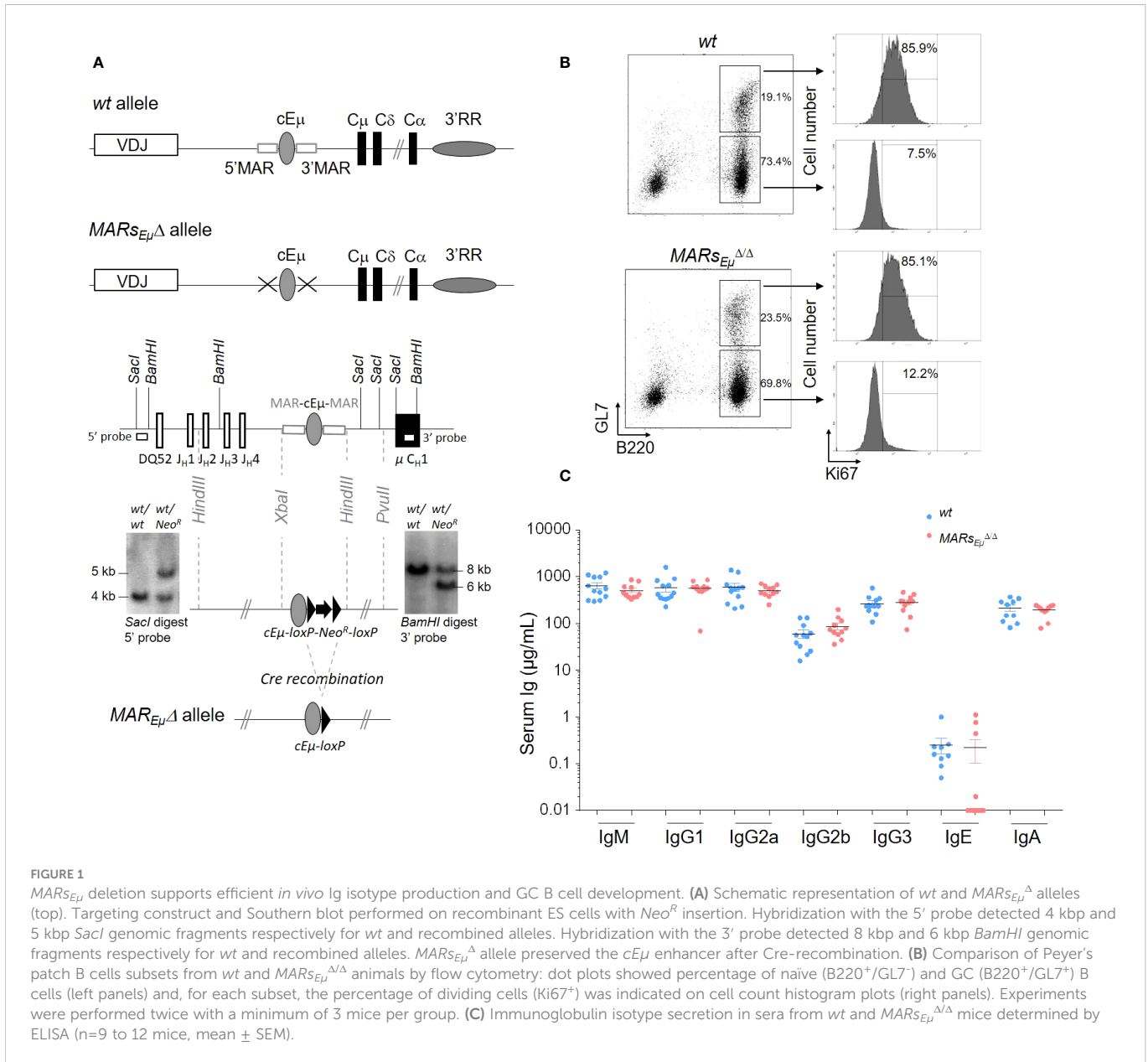

statement is in agreement with previous studies of an analogous MAR region in the *Igκ* locus (24).

MARSEμ deletion inverts SHM distribution on both sides of the Eμ enhancer region

To assess whether *MARSEμ* deletion could affect *IgH* somatic hypermutation, we first quantified mutations within the 500-bp regions downstream from the variable exons rearranged to *J_H3* and *J_H4* segments (Figure 2A) in Peyer's patch GC B cells sorted from *wt* and *MARSEμΔ/Δ* (animals overall data reported in Figure 2 left, data from individual animals reported in Supplementary Figure S2 and Supplementary Tables S2A, B). For this we used two complementary sequencing methods: the first one, based on classical Sanger approach and GS junior technology, allowed to discriminate and exclude unmutated and clonally related sequences from the calculation of

SHM frequency, as initially described (27). The second method used Ion proton deep sequencing coupled to DeMinEr filtering. Since using DNA templates including non-mutated alleles, this second approach underestimated the SHM frequency; but since including AID-deficient control samples as a reference, the method provided highly reproducible and reliable quantification of SHM in a DNA sample extracted from GC B cells (28). Interestingly, by using Sanger approach, *MARSEμΔ/Δ* GC B cells displayed significant differences in the distribution of mutations: an increased proportion of unmutated sequences (less than 10% in *wt* compared to 38% in *MARSEμΔ/Δ*) (from 30.6 to 45.5%, overall data collected from several mice, data from independent mice in Supplementary Figure S2A) Another effect of *MARSEμ* deletion on *IgH* SHM targeting was the strong decrease in highly mutated sequences (>10bp per sequence). In *wt*, the proportion of highly mutated alleles reached ~24% (from 18.9 to 28.3%) while in mutants they were barely present (~2%) (Figure 2B left and Supplementary Fig S2A). When comparing only the mutated

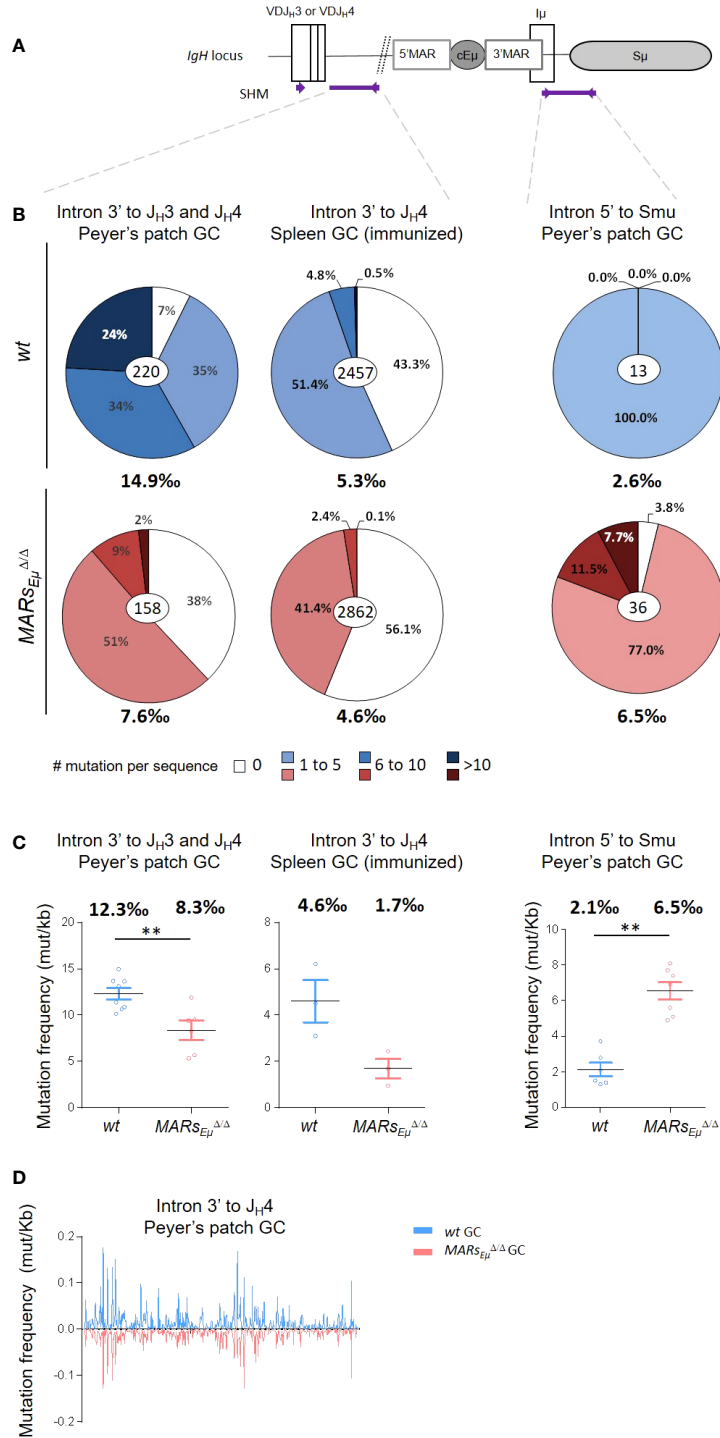

FIGURE 2

MARSE_μ deletion impairs the overall SHM frequency and distribution within the *IgH* J-C intronic region. (A) Location of *IgH* regions (thick purple lines) tested for SHM, arrows represent primers used for PCR amplification. (B) Pie charts represent distribution of mutated sequences (proportional to the area in each slice, data obtained by Sanger and GS Junior sequencing method) quantified in wt and MARSE_μ^{ΔΔ} mice in individually recombined *IgH* alleles. For each genotype number of individual clones is indicated in the center (after removal of clonally related sequences based on VDJ junction) and overall mutation frequencies (mutation per 1000 bp in mutated clones) are indicated below. Left: SHM downstream from J_H3 and J_H4 segments in Peyer's patch sorted GC B cells, data obtained after cloning and sequencing by classical Sanger method. Middle: SHM downstream from J_H4 segments in spleen GC B cells sorted from SRBC-immunized mice, data obtained by NGS (GS Junior). Right: SHM downstream from cE_μ region from Peyer's patch GC sorted B cells, data obtained by classical Sanger method. (C) Graphical representation of SHM frequency in wt and MARSE_μ^{ΔΔ} mice, quantified by NGS (Ion Proton) submitted to DeMinEr filtering, a pipeline that identifies substitution frequency at each nucleotide based on an *Aicda*^{ΔΔ} control sample (28). Since no indication in sequence distribution is available using this method, data were represented as scattered plots, each point refers to a mutation frequency from one individual mice, mean mutation frequencies are indicated above. p-value was determined with two tailed Mann Whitney test; significant differences are indicated by: **P < 0.01 and error bars represent SEM of two independent experiments. (D) Mutation distribution along the J_H4 intron in wt (top) and in MARSE_μ^{ΔΔ} (bottom).

sequences, mutation frequency was decreased at least by two fold in $MARs_{E\mu}^{\Delta/\Delta}$ mutants, with 7.6 mutations per 1000 bp (in average) compared to 14.9 in *wt* (in average) (Figure 2B left and Supplementary Figure S2A). By using next generation sequencing (NGS), the decreased SHM frequency was also highly significant (Figure 2C, 12.3‰ vs 8.3‰, $p=0.008$, individual mice in Supplementary Table S2A).

To monitor SHM upon antigen challenge, we analyzed mutations by Sanger and NGS in a large number of GC B cells sorted from spleen of SRBC-immunized $MARs_{E\mu}^{\Delta/\Delta}$ and *wt* mice. In parallel; we verified on spleen frozen section that efficient GC formation was indeed comparable between $MARs_{E\mu}^{\Delta/\Delta}$ and *wt* mice (Supplementary Figure S2B). In the intronic region downstream from the J_H4 segment, SHM frequency dropped from 5.3 (Sanger method, excluding unmutated clones) or 4.6 (NGS bulk method) mutations per 1000bp in *wt* cells to respectively 4.6 or 1.7 in $MARs_{E\mu}^{\Delta/\Delta}$ cells (Figure 2B middle, and 2C, Supplementary Figure S2C, Supplementary Table S2B). Similarly to what was observed in spontaneous GC B cells from Peyer's patches, NGS assays performed on few immunized animals also showed that SHM was decreased upon $MARs_{E\mu}$ -deletion only eight days after antigen challenge (Figure 2C middle). Immunization assays also showed an increased proportion of unmutated or poorly mutated sequences in $MARs_{E\mu}$ -deficient B cells (Figure 2B and Supplementary Figure S2C). This confirmed that the intronic region was less efficiently targeted by SHM in $MARs_{E\mu}$ deficient mice. An identical SHM defect was also observed in mice harbouring deletion of the entire $E\mu$ region (core enhancer and flanking MARs; (9)) (Supplementary Figure S2A top right); this data indicated that the SHM failure was the only consequence of MARs deletion. This hypothesis is completely consistent with a previous study showing that SHM efficiency was not affected by the endogenous deletion of the $cE\mu$ enhancer alone (7). The comparison between those three models is certainly relevant since all knock outs were created in murine germlines with similar mixed genetic backgrounds.

To reinforce the unbiased SHM evaluation within J_H introns, we sought to evaluate the impact of $MARs_{E\mu}$ deletion on acquired diversity of the VDJ exon by quantifying SHM events taking place in the out of frame (passenger) IgH alleles. This parallel unbiased analysis was made possible in a region physiologically highly targeted by SHM (overlapping parts of the FR3 and CDR3 domains) thanks to the IMGT/HighV-QUEST reference tool (29). Although focused on a restricted region of out of frame VDJ exons, this study performed on GC cells sorted from Peyer's patches still highlighted a decreased SHM frequency in the $MARs_{E\mu}^{\Delta/\Delta}$ model (~27‰ in mutants compared to ~32‰ in *wt*, Supplementary Table S3). This strongly suggests that the SHM defect observed within J_H introns in the absence of $MARs_{E\mu}$ extends to their respective upstream VDJ exons.

Since our $MARs_{E\mu}$ deletion includes the 3'*Hinfl*-*XbaI* genomic region that contains transcription start sites and part of the $I\mu$ exon (6, 30), we also quantified SHM immediately downstream from this exon in a 629bp region described as mutated in GC B cells (Figure 2A) (31, 32). Unlike the intronic regions downstream from the rearranged VDJ exon, the overall mutation frequency downstream from $I\mu$ was strongly increased in GC B cells devoid of $MARs_{E\mu}$ region and reached 6.5 (in average) mutations per 1000 bp compared to 2.6 (in average) in *wt* cells (Figure 2B right). This suggests that the region downstream

from the $cE\mu$ was more efficiently targeted in the absence of its MARs. This was supported by the very low proportion of unmutated sequences in *wt* (Figure 2B right and Supplementary Figure S3A) and the increased proportion of highly mutated sequences in $MARs_{E\mu}$ -deficient GC B cells (Figure 2B right and Supplementary Figure S3A). This data was efficiently confirmed by NGS analysis that estimated that mutation frequency was increased by 3.5 fold in the $MARs_{E\mu}$ -deficient GC B compared to *wt* mice (2.1‰ vs 6.5‰) (Figure 2C right and Supplementary Table S2C). In our mouse model, 3'MARs deletion brought $S\mu$ region closer to the $cE\mu$ enhancer element. Given this, we also calculated SHM frequency in a 473bp region located at the same distance from the $cE\mu$ element in *wt* and $MARs_{E\mu}$ -deficient mice. Similarly to what was reported in Figure 2, we also observed, at the same distance of $cE\mu$, an increase in SHM frequency upon $MARs_{E\mu}$ -deletion (Supplementary Figure S3B).

Analysis of mutation distribution in *wt* and in $MARs_{E\mu}^{\Delta/\Delta}$ mice did not show any difference between models (Figure 2D), indicating that, while affecting SHM efficiency, the absence of $MARs_{E\mu}$ region did not influence DNA sequence hotspot or preferences for SHM within the J_H4 intron.

Importantly, our mouse model clearly assigns a specific function for endogenous $MARs_{E\mu}$ on SHM at the *IgH* locus, in accord with the requirement of similar regions for efficient SHM previously pointed out in the endogenous *Igk* Kappa light chain locus. This pioneer study, describing the specific deletion of a 420bp MAR region upstream from the intronic Kappa enhancer (*Ei* κ), highlighted a modest decrease in SHM by quantifying mutations downstream from the $J_{\kappa}5$ segment in GC B cells from Peyer's patches (24). While our study suggests that $MARs_{E\mu}$ optimizes SHM upstream from the $cE\mu$ enhancer; the presence of such regulatory regions does not prevent the SHM machinery to get access to downstream regions as reported in a recent study (33). This hypothesis is mostly supported by the increased SHM frequency downstream from the $cE\mu$ enhancer in the absence of $MARs_{E\mu}$, a finding consistent with previous works describing increased $S\mu$ internal deletions in hybridomas devoid of MARs regions (34). We could speculate that one physiological function of $MARs_{E\mu}$ regions in GC B cells is to tightly isolate the VDJ transcription unit by, at least temporarily, attaching the $E\mu$ region to the nuclear matrix. Such a "locked" target conformation could provide an optimal environment for somatic mutations by trapping the transcription machinery and its co-factors including AID and error-prone repair factors. This topological barrier could, at the same time, partially protect downstream constant regions from SHM; although this configuration should be brief since regions downstream from $E\mu$ are also efficiently targeted by AID in GC B cells (35).

$MARs_{E\mu}$ deletion modifies transcription patterns on both sides of the $E\mu$ enhancer region

It is well established that SHM in Ig V segments is coupled to transcription initiated at V promoters (36). To investigate transcription-related events in SHM-targeted regions upstream and downstream from $E\mu$, we precisely quantified the total amounts of steady state total *IgH* primary transcripts by using multiple q-PCR

probes located respectively downstream from J_{H4} and J_{H3} : the previously described probe A (37) (Figure 3A and Supplementary Figure S4) complemented by probes A' and C (Supplementary Figures S4, S5). The use of cDNA templates conducted with random hexamers showed that the amount of total IgH primary transcripts running upstream from $E\mu$ did not display significant variations between *wt* and $MARs_{E\mu}$ -deficient cells in both GC and *in vitro*-stimulated samples by using probe A (Figure 3B) as well as with probes A' and C, although an upward trend could be noticed in LPS-activated samples (Supplementary Figure S5A left). The intriguing discrepancy between the mutation phenotype observed in $MARs_{E\mu}$ -deficient GC B cells and the silent effect on global transcription motivated a more complete study of transcription events occurring upstream from $E\mu$, particularly sense and antisense transcription since the latter has been found in cells undergoing SHM (38). To proceed, we generated cDNA templates with sense transcripts, initiated at the promoter of the rearranged *VDJ* segment, with three primers located downstream from the J_{H4} segment (S1 and S2) and within the *cE\mu* enhancer (S3) (Figure 3C and Supplementary Figure S4, S5A). Reciprocally, we generated cDNA templates with antisense transcripts, initiated in the intronic regions upstream from $E\mu$ as described by Perlot et al. (38), with four primers respectively located downstream from J_{H2} (AS0), J_{H3} (AS1) and J_{H4} (AS2 and AS3) (Figure 3E and Supplementary Figure S4 and S5B). For both sense and antisense, quantification of steady state transcripts was possible with the same probes A, A' and C. For strand-specific quantification assays with a given probe, the baseline level was either provided by a control reaction (P-) measuring endogenous priming since devoid of primer or by one strand-specific template that cannot be detected by the probe (T-) as reported previously (39, 40). To note, strand-specific transcripts were optimally detected when primers and probes were closer (sense transcripts with primer S1/probe A or antisense transcripts with primer AS2/probe A). Side by side comparison of *wt* and $MARs_{E\mu}$ -deficient activated B cells samples revealed several interesting differences. When quantified with optimal primer S1/probe A tandem, sense transcripts were significantly increased in the absence of $MARs_{E\mu}$ (Figure 3C). In GC B cells, a two fold increase was noticed by using S1 template (Figure 3C, left bar graph, $p=0.019$). In *in vitro*-activated cells, an increase of sense transcription was also observed upon $MARs_{E\mu}$ -deletion, this effect became significant for long transcripts that reach the *cE\mu* (Figure 3C, right bar graphs, $p=0.004$ for S3/probe A). By using A' and C probes, sense transcripts were hardly detectable in GC samples (Supplementary Figure S5A; middle bar graphs); although a significant increase was noticed with S3/probe C ($p=0.043$) and S2/probe C ($p=0.02$) tandems in LPS-activated samples upon $MARs_{E\mu}$ -deletion (Supplementary Figure S5A; right bar graphs). As a potential consequence of the increased transcription of the *VDJ* unit in observed upon $MARs_{E\mu}$ deletion, we measured by flow cytometry the level of intracellular Ig μ chain in Peyer's patch GC B cells (B220⁺/GL7⁺) of *wt* and $MARs_{E\mu}^{\Delta/\Delta}$ mice. The significant increase of Ig μ chain expression in the absence of $MARs_{E\mu}$ region (Figure 3D, $p=0.002$) corroborate our sense-transcription data. This indicated that the absence of $MARs_{E\mu}$ certainly did not hamper RNA pol II machinery to progress 3' to the *VDJ* unit and might even facilitate this process in activated cells.

Globally less abundant than their sense counterparts, quantification of antisense transcripts running downstream from J_H segments showed quite different patterns (Figure 3E and Supplementary Figure S5B). While quite similar levels were detected in LPS-activated samples (Figure 3E right and Supplementary Figure S5B), intronic antisense transcripts were about 2 fold less abundant in $MARs_{E\mu}$ -deficient GC B cells when detection was allowed by optimal probe/primer combination (Figure 3E, left, $p=0.025$, AS2/probe A and Supplementary Figure S5B left, $p=0.041$ for AS3/probe A'). As a complementary experiment, sense and antisense transcription patterns were also determined in naive B cells in order to assess whether the influence of MARs was restricted to the activated stage. Data proved this was the case since, in naive cells sorted from Peyer's patches, transcription patterns as well as intracellular IgM levels were unchanged in *wt* and $MARs_{E\mu}^{\Delta/\Delta}$ mice (Supplementary Figures S6A, B); identical transcription patterns were also observed in splenic resting B cells (Supplementary Figure S6C).

The obvious unbalanced sense/antisense transcription ratio could result from either weak transcription efficiency or instability of antisense products. Nevertheless, Perlot et al. identified by RACE assays, in normal GC B cells, multiple antisense-transcript initiation start sites downstream from every J_H region and raised the question of specific enhancers. Our current data refines this previous study by identifying $MARs_{E\mu}$ as potential boosters of antisense transcripts that, given their proximity to the enhancer, could achieve some regulatory function like eRNA or PROMPT/uaRNA (41). Highlighting a correlation between mutation efficacy and strand-specific transcription pattern upstream from $E\mu$, our data support the idea that some level antisense transcription downstream from the *VDJ* exon could prepare to SHM (38). Seemingly transient, specific to cell subsets and occurring upstream from an enhancer, such antisense transcripts could be substrates for RNA exosome and lead to optimized SHM targeting as proposed by Basu and colleagues (42–44).

Since a strong increase of mutations was observed within the $S\mu$ region in the absence of $MARs_{E\mu}$, we also sought to correlate SHM and transcription on the other side of *cE\mu* by quantifying total transcripts (probe B) running in this region (Figure 3A). In this case and according to what could be expected, transcription was significantly increased in $MARs_{E\mu}$ -deficient GC B cells from Peyer's patches (Figure 3F left, $p=0.04$); a similar trend, although not significant, was observed in LPS activated B cells (Figure 3B right $p=0.32$). Accordingly, we also observed a modest but reproducible increase of CSR C γ 3 and C γ 1 in $MARs_{E\mu}$ -deficient B cells stimulated *in vitro* respectively by LPS or by LPS + IL4 cocktail (Supplementary Figure S7). A similar modest CSR effect associated to $S\mu$ internal deletions has been previously reported in hybridomas carrying the same $MARs_{E\mu}$ -deletion (34). This indicated that the absence of $MARs_{E\mu}$ leads to a global increase in transcription of the donor S region and consequently favours SHM targeting.

The significant changes in transcription patterns upstream and downstream from *cE\mu* observed in our models put forward the hypothesis that $MARs_{E\mu}$ act as physiological barriers in activated B cells, limiting sense transcription of the *VDJ* unit up to the intronic enhancer. For transcription running through the $S\mu$ region, our data is in agreement with a repressive function of $MARs_{E\mu}$ in activated B

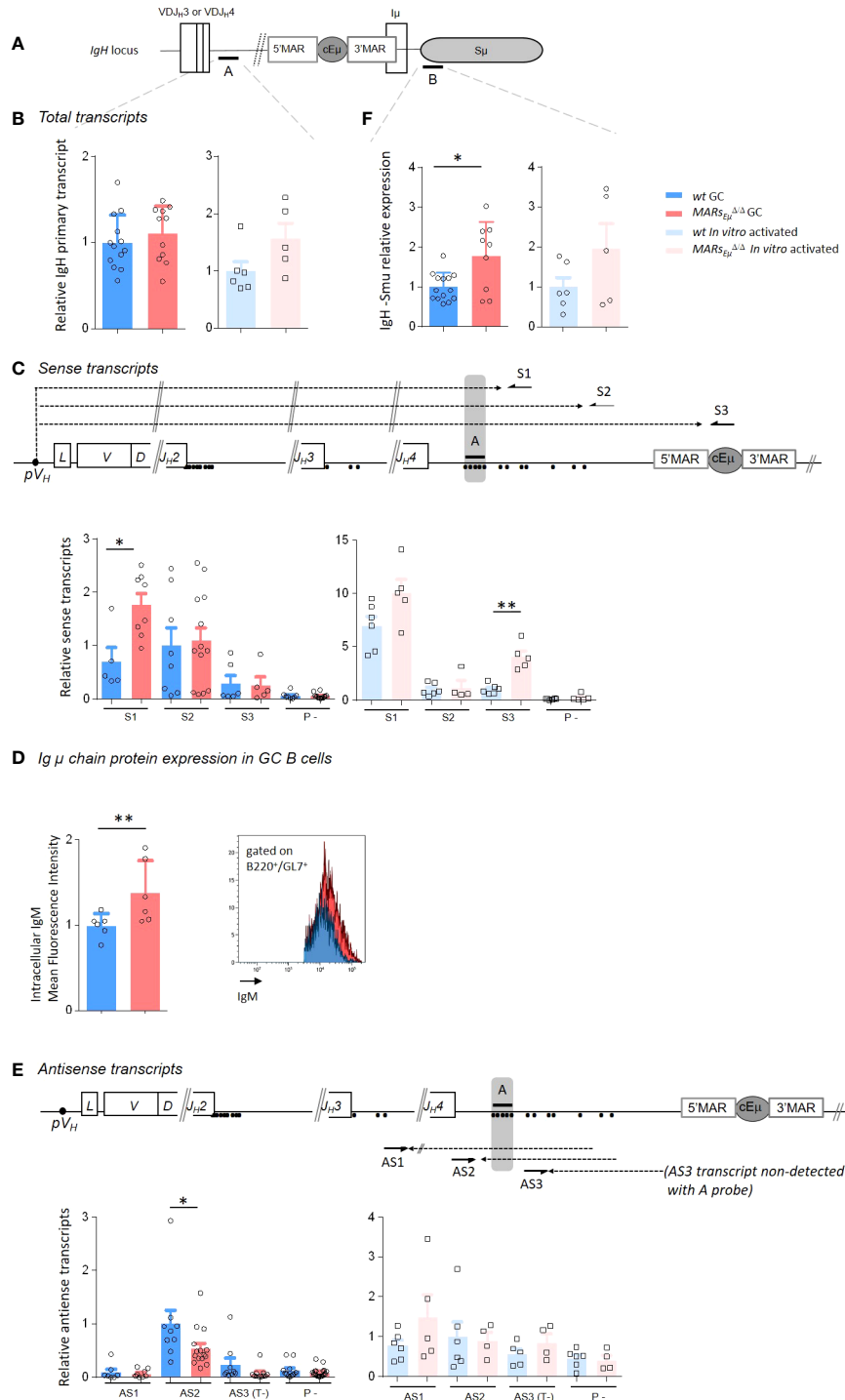

FIGURE 3

MARS_{Eμ} deletion impairs strand-specific transcription upstream from *Eμ* region. **(A)** *IgH* locus specifying location of q-PCR probes **(A, B)** used for transcripts quantification. **(B)** Total primary transcripts quantified downstream from the *J_{H3}* segment with probe A in Peyer's patch GC B cells (dark colors) and *in vitro*-activated B cells (light colors) from wt and *MARS_{Eμ}^{Δ/Δ}* mice. **(C)** Detection of sense transcripts (dotted arrows) in murine *IgH* locus (not to scale). Arrows indicate primers (S1, S2, S3) downstream from *J_{H3}* and *J_{H4}* used for strand-specific reverse transcription. Primary sense transcripts were quantified with probe A (black bar) in Peyer's patch GC B cells and *in vitro*-activated B cells from wt and *MARS_{Eμ}^{Δ/Δ}* mice. Dots indicate antisense transcript start sites according to Perlot et al. (38). Baseline levels were defined by using a RT template performed without primers (P-). Bar graphs show the relative quantity of sense transcripts obtained from template S1, S2 and S3 (mean ± SEM) from two to three independent experiments. **(D)** Intracellular IgM mean fluorescence intensity measured by flow cytometry in GC B cells from Peyer's patches of wt and *MARS_{Eμ}^{Δ/Δ}* mice. Bar graphs indicate data from individual mice (*n*=6 mice in 2 independent experiments, mean ± SEM); a representative example of cell count overlay is shown. **(E)** Detection of antisense transcripts (dotted arrows) in murine *IgH* locus (not to scale). Arrows indicate primers (AS1, AS2, AS3) downstream from *J_{H3}* and *J_{H4}* used for strand-specific reverse transcription. Primary antisense transcripts were quantified with probe A (black bar) in Peyer's patch GC B (dark colors) cells and *in vitro*-activated (light colors) B cells from wt and *MARS_{Eμ}^{Δ/Δ}* mice. Dots indicate antisense transcripts start sites according to the Alt study (38). Baseline levels were defined by using a RT template performed without primers (P-) or by using a strand-specific template that cannot be detected with A probe (T-). **(F)** Total primary transcripts quantified downstream from cEμ region with probe B in Peyer's patch GC B cells (dark colors) and *in vitro*-activated B cells (light colors) from wt and *MARS_{Eμ}^{Δ/Δ}* mice. p-value was determined with two tailed Mann Whitney test; significant differences are indicated by: **P* < 0.05; ***P* < 0.01 and error bars represent SEM of two to three independent experiments.

cells, in order to limit SHM targeting of this area. However, our data also suggest that *MARs_{Eμ}* act as transcriptional repressors of the *VDJ* unit in both naïve and activated cells; a statement in contradiction with our hypothesis that *MARs_{Eμ}* facilitates SHM upstream from *cEμ*. To settle such a discrepancy in our *MARs_{Eμ}*-deficient B cells, we first questioned AID deamination efficiency and second error-prone repair pathways processing in SHM targeted regions: upstream and downstream from *cEμ*.

MARs_{Eμ} deletion impairs error-prone repair pathway upstream from the *Eμ* enhancer region

One critical experiment needed to challenge the function of *MARs_{Eμ}* as physiological barrier for SHM machinery was to first assess whether IgH AID targeting could be impaired in the absence of *MARs_{Eμ}*. To proceed, we bred our *MARs_{Eμ}*-KO mice in a genetic background deficient for both base excision repair (*Ung^{Δ/Δ}*) and mismatch repair (*Msh2^{Δ/Δ}*) in order to evaluate, on an unbiased manner, the DNA footprint of AID deamination upstream and downstream from *cEμ* (Figure 4A). As expected and according to the literature (45–47), models deficient for both BER and MMR displayed only transitions at C/G pairs reflecting cytidine deamination on

respectively the template and non-template strands. By looking at deamination frequencies between control (*Ung^{Δ/Δ} Msh2^{Δ/Δ}*) and mutant animals (*Ung^{Δ/Δ} Msh2^{Δ/Δ} MARs_{Eμ}^{Δ/Δ}*), our data showed that AID activity upstream from *cEμ* was not impeded upon *MARs_{Eμ}*-deletion; while differences were not statistically significant (evaluated on n=3 to 4 mice of each genotype), cytidine deamination even tended to be increased in B cells devoid of *MARs_{Eμ}* on both sides of *cEμ* (Figure 4B and Table S4A). When compared to control animals (*Ung^{Δ/Δ} Msh2^{Δ/Δ}*), nucleotide substitution patterns were unchanged in the absence of *MARs_{Eμ}* (Figure 4B and Supplementary Figure S8A), proving identical strand-specific cytidine deamination: roughly 2/3 on the non-template strand (C to T substitutions) and 1/3 on the template strand (G to A substitutions). Besides imbalanced transcription upstream from *Eμ*, this data indicates that *MARs_{Eμ}*-deletion does not impact the choice of any DNA strand for AID targeting within intronic regions.

This notable increased AID deamination footprint prompted by *MARs_{Eμ}*-deletion was in total agreement with the increased transcription observed in the corresponding regions of activated B cells. The obvious discrepancy between efficient C to U deamination events and the strong SHM targeting defect within the same *J_H* intron region unravel the origin of the SHM defect in *MARs_{Eμ}*-deficient mice as a default of the mutagenic process occurring downstream from the normally-introduced U-G mismatches in DNA.

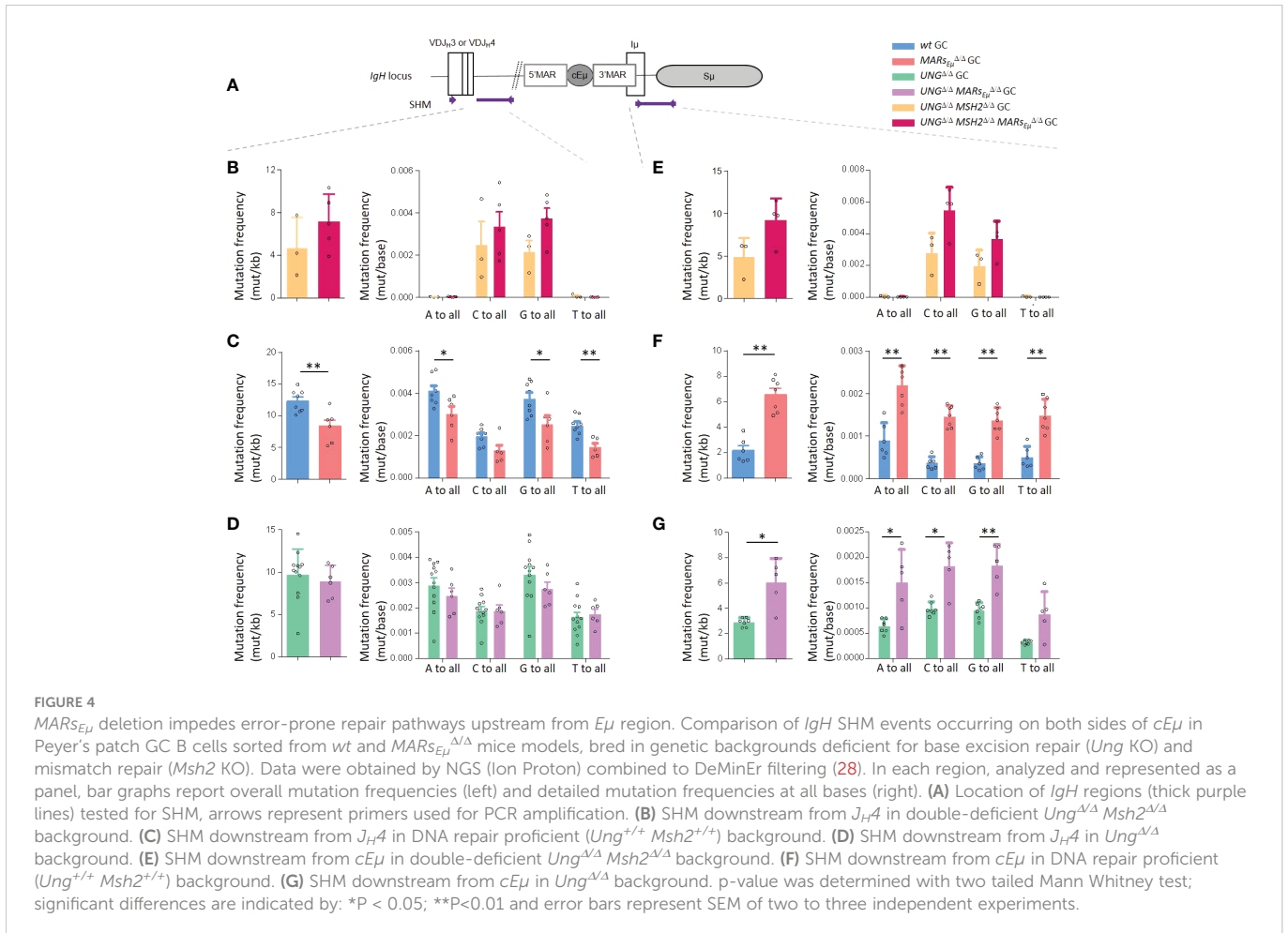

This prompted us to investigate whether $MARs_{E\mu}$ -deletion could provoke skewed mutation patterns within SHM-targeted regions. In the intron region downstream from J_H4 , mutation frequency at each of the four bases in *wt* and $MARs_{E\mu}$ -deficient backgrounds (Figure 4C and Table S2A) revealed a global significant decrease of mutations at all bases except for substitutions occurring at C in the absence of $MARs_{E\mu}$. Similarly, beyond significant differences for C>A, G>C, T>A and T>G events, individual mutation patterns unveiled a global decrease that did not offer any clear hypothesis regarding the mechanism impeding SHM upon $MARs_{E\mu}$ -deletion. Factually, the unchanged relative proportion of transitions and transversions at C:G base pairs in $MARs_{E\mu}$ deficient cells did not suggest any defect in UNG activity (45, 48, 49) (Supplementary Figure S8B).

To solve this paradox, we bred our $MARs_{E\mu}$ -KO mice into base excision repair deficient background ($Ung^{\Delta/\Delta}$) and analysed SHM in the same region. Strikingly, in the absence of UNG, SHM frequency within the J_H4 intron region was identical upon the presence ($Ung^{\Delta/\Delta}$ control mice) or the absence of $MARs_{E\mu}$ ($Ung^{\Delta/\Delta} MARs_{E\mu}^{\Delta/\Delta}$ mice) (Figure 4D and Supplementary Table S4B). Beyond the expected increase of G/C transitions, a typical hallmark of UNG-deficient background, substitution frequencies at all four bases were also identical in $Ung^{\Delta/\Delta} MARs_{E\mu}^{\Delta/\Delta}$ mice (Figure 4D) the same was true when looking at individual substitution events (Supplementary Figure S8C). The fact that the SHM deficiency induced by $MARs_{E\mu}$ deletion was no more observed in UNG-deficient background (Figures 4C, D) strongly imply the involvement of BER pathway in the initial mutagenic defect. This same data also proved that SHM events occurring independently of UNG (e.g. altogether obtained by replication across U and/or processed by MMR pathway) took place normally within the J_H intron in the absence of $MARs_{E\mu}$. Given this, a rational hypothesis to explain the origin of the SHM defect in our model was that abasic sites generated by UNG upstream from $cE\mu$ are processed differently upon the absence of $MARs_{E\mu}$. Our data suggests that U:G mismatches processed by UNG are accurately repaired in the absence of $MARs_{E\mu}$ while these are normally subject to error-prone repair; sustaining for a specific function of $MARs_{E\mu}$ in recruiting mutagenic factors associated to BER.

In contrast to what observed in the J_H intron, substitution frequencies and mutation patterns downstream from $cE\mu$ evidenced a different function for such regulatory regions. In B cells capable of BER and MMR, the absence of $MARs_{E\mu}$ significantly boosted mutations at all bases by at least two fold (Figure 4F), this was true for any kind of substitution (Supplementary Figure S8E). Substitution patterns collected in mutant animals devoid of BER and MMR highlighted a global “overtargeting” of the $S\mu$ region induced by $MARs_{E\mu}$ deletion (Figure 4E, Supplementary Figure S8D and Supplementary Table S4C). This was in line with the general increase in both $S\mu$ germline transcription observed in this model. In models impaired for BER, our data showed that UNG-deficiency combined to deletion of $MARs_{E\mu}$ ($Ung^{\Delta/\Delta} MARs_{E\mu}^{\Delta/\Delta}$ mice) maintained the SHM burden downstream from $cE\mu$ significantly higher than what observed for UNG alone ($Ung^{\Delta/\Delta}$ control mice) (Figure 4G; Supplementary Figure S8F and Supplementary Table S4D). Such a comparison suggests that error-prone repair factors could more readily access to abasic sites generated in the S region when $MARs_{E\mu}$ are missing. In this way, our data support the idea that $MARs_{E\mu}$ act as physiological barrier that optimize SHM upstream from the $E\mu$ region and rationalize the fact that $MARs$ are

evolutionary conserved downstream from Ig gene V regions (24); and moreover conserved structures in mammals (2).

Concluding remarks

One simplistic model would argue that the most important regulatory regions for IgH locus expression are conserved upon any reshaping event occurring in developing B lineage cells (VDJ recombination, CSR and SHM). Beyond the major enhancer regions, e.g. $cE\mu$ and the 3'RR, our current study identifies $MARs_{E\mu}$, also conserved upon any rearrangement, as part of these most critical IgH elements. Since flanking $cE\mu$, $MARs_{E\mu}$ could potentially interfere with the function of this regulatory element. Our current study showed that $MARs_{E\mu}$ deletion impact the transcription pattern in this region but also points out, when compared to deletion of $cE\mu$ alone (7), that the core enhancer and $MARs_{E\mu}$ act independently on SHM. Our data indicate that IgH $MARs_{E\mu}$ delimit, upstream from the enhancer region, some error-prone repair processes coupled to BER.

Several studies indeed proposed that J - C intronic $MARs$ help generate negative supercoiling and consequently increased ssDNA and potential other secondary structures that could promote accessibility to AID (50–52). The hypothesis that $MARs_{E\mu}$ add again more DNA strain to the sense-transcribed VDJ transcription unit is relevant to the positive effect of topoisomerase depletion on AID targeting and SHM (51, 53, 54). In line with transcription dynamics, RNA pol II stalling (55, 56) and DIVAC regulatory regions are being proposed to facilitate AID targeting for SHM (57, 58). A model proposed by Alt and colleagues (59) would be that the optimal chromatin environment for AID-induced mutations would be provided by convergent transcription as the result of fine balance between sense and antisense events. As possible byproducts of RNA Pol II collision, antisense or regulatory transcripts in such regions remain transient and difficult to detect in a *wt* context; probably because processed by RNA exosome or other RNase activities (60, 61). In line with our data, a recent study from the Basu group emphasize the critical function of the RNA exosome for the fine tuning of sense transcription of the VDJ exon, leading to modifications on strand-specific AID targeting and SHM (44). While also modifying sense and antisense transcription pattern, our study shows that $MARs_{E\mu}$ -deletion does not impede AID footprint but rather some of repair mechanisms acting downstream from the U-G mismatch. Since we hypothesize that UNG activity by itself is not necessarily impaired in our model, our data strongly suggest that only BER-dependent error-prone repair is impeded by $MARs_{E\mu}$ -deletion. This statement supposes that efficient MMR-dependent error-prone repair in this region does not require such a barrier. The question of $MARs$ binding factors and their respective dynamic association to such regulatory regions needs to be further investigated. The literature already suggest that some of them, like the Special AT-rich binding factor 1 (SATB1), could act as accessory factors in BER (62). Recent findings, showing that UNG2-interacting protein FAM72A promotes error prone processing of U-G mismatch in Ig genes (48, 49), raise the question of its specific recruitment to AID-targeted regions; our current study suggests that $MARs_{E\mu}$ could potentially interact with error-prone factors acting downstream from UNG2. Another future challenge remains to define whether some components of the nuclear matrix, nuclear filaments or proteins anchored in the envelope, could be involved in the anchorage of SHM targets.

Material and methods

Mouse models

To generate $MARs_{E\mu}$ KO model, gene targeting for matrix attachment regions flanking the *IgH E μ* enhancer element was performed by homologous recombination, in the murine E14 ES cell line, with a vector kindly provided by Dr. Frederick Alt that permitted replacement of the 995 pb region (including *cE μ* and its flanking *MARs*) by a 220 pb *Hinfl* genomic fragment that reintroduced the *cE μ* enhancer, a 256 bp fragment containing plasmid sequence and a “*loxP-pGK-Neo^R-loxP*” cassette (18). Once introduced in the mouse germline, the selection cassette was deleted *in vivo* by *cre-loxP* recombination as previously described (9) to obtain the $MARs_{E\mu}^{\Delta\Delta}$ *IgH* allele devoid of both 5' and 3' $MARs_{E\mu}$ (respectively 344 pb *XbaI-Hinfl* and 426bp *Hinfl-XbaI* genomic fragments) (Figure 1A). Animal procedures were performed on 8 weeks old male and female mice. All models were created in mixed 129Sv;C57BL/6 background. *Wt*, $MARs_{E\mu}^{\Delta\Delta}$, $E\mu^{\Delta\Delta}$ (9), *Msh2^{ΔΔ}*, *Ung^{ΔΔ}* (a kind gift of Dr S. Storck) and *Aicda^{-/-}* (a kind gift of Pr. T. Honjo) homozygous mice were used for our experiments and maintained at 21–23°C with a 12-h light/dark cycle. All experiments comparing *Wt*, $MARs_{E\mu}^{\Delta\Delta}$, $E\mu^{\Delta\Delta}$ in DNA repair proficient background used systematically control mice carrying two *IgH* alleles of the same haplotype: *IgHa* (from 129/Ola strain). Procedures were reviewed and approved by the Ministère de l'Éducation Nationale de l'Enseignement Supérieur et Recherche autorisation APAFIS#16639-2018090612249522v2.

Southern blots and PCR analysis of *cre*-mediated $MARs_{E\mu}$ deletion

Genomic Southern blots were performed as follows: 20 μ g genomic DNA were digested by *SacI* or *BamHI* and submitted to electrophoresis on a 0.7% agarose gel. DNA was transferred to nylon membranes (MP Biomedicals) by capillarity. Blots were hybridized with [³²P]-labeled probes generated by random priming. Hybridization with 5' probe (0.803 kpb *SacI-SphI* fragment) and 3' probe (0.8 kpb *XbaI-BamHI* fragment) located outside the homology arms were used to identify ES cell clones in which $MARs_{E\mu}$ were replaced by the *loxP-pGK-Neo^R-loxP* cassette (Figure 1A).

Total serum Ig quantification by ELISA

Sera were collected at 8 weeks of age from non-immunized *wt* and $MARs_{E\mu}^{\Delta\Delta}$ mice and analyzed for the presence of different Ig classes and subclasses by ELISA as previously described (63).

SRBC immunisation

Mice were challenged by intraperitoneal injection with 200 μ L 50% sheep red blood cell suspension and sacrificed 8 days later to collect GC B cells ($B220^+/GL7^+$) in the spleen. Efficient immunization was assessed by counting GC numbers on spleen frozen sections upon immunofluorescence labelling.

Immunofluorescence labelling of germinal center structures

Spleens cryosections (10 μ m) were fixed and permeabilized for 20 minutes in cold acetone at -20°C. Sections were stained with the following primary Abs GL7-FITC (1/50), α B220 APC (1/1000), α IgD-AF594 (1/1000) diluted in PBS/FCS 2%/EDTA 2mM, overnight at 4°C. After 2 washes with PBS, DAPI was added. Images were acquired using an epifluorescent microscope (NIKON). GC structures were identified according to their content in $B220+GL7+$ cells.

Flow cytometry and cell sorting

Flow cytometry analysis was performed on LSR-Fortessa cell analyzer (BD Biosciences) on single-cell suspensions from fresh organs. Once washed with 2% fetal calf serum-PBS, lymphoid cells from bone marrow, spleen, peritoneal cavity and Peyer's patches were labeled with various conjugated Abs: α B220-V450, α CD117-PE, α CD43-PE for bone marrow cells. α B220-V450, α CD21-PE, α CD23-FITC, α IgM total-PE, α IgD-FITC and α CD3e-FITC for splenocytes. α B220-V450, α IgM-PE, α CD5-FITC for peritoneal cavity. α B220-V450, α B220-APC, α IgA-FITC, α IgM-PE, α PNA-FITC, α FAS-PE, α Ki67-FITC and GL7-FITC for Peyer's Patches. (Southern Biotechnology Associates; eBioscience; Sigma and BD Biosciences). Flow cytometry cell sorting was performed on an ARIA 3 (BD Biosciences) apparatus on single-cell suspensions from spleens or Peyer's patches. Once washed with 2% fetal calf serum-PBS, cells were labeled with PNA, GL7, α B220, and α FAS reagents and sorted based on distinct gates defined as germinal center B cells ($B220^+/GL7^+$ or $B220^+/PNA^{\text{High}}/Fas^+$).

Cell culture

Splenocytes were collected, after red blood cells lysis, $CD43^+$ cells were depleted using anti-CD43 MicroBeads (Miltenyi Biotec). $CD43^-$ splenic B cells were cultured for 3 days at a density of 1×10^6 cells per mL in RPMI 1640 supplemented in 10% serum calf fetal, sodium pyruvate (Lonza), amino acid (NEAA 100x Lonza) and Penicillin-Streptomycin (Gibco) with 1 μ g/ml LPS (*In vivo*Gen) alone (for transcription assays) or plus 20ng/ml IL4 (PeproTech) (for CSR experiments).

SHM assays

SHM analysis within the *J_H4* intron was either performed by cloning followed by classical Sanger method as described (64) or performed directly on PCR products by next generation sequencing using GS Junior (Roche) or Ion Proton system (Applied Biosystem). SHM within *Smu* intron was performed by using the following primer *SmuF*: 5'-AAGGGCTTCTAAGCCAGTCC-3' and *SmuR*: 5'-TAGCCTGGGTCCCTCCTTAC-3' and sequenced using GS junior sequencer. For GS Junior, sequencing libraries were prepared

according to the manufacturer's instructions, adaptor sequences were added to the previous amplification primer sequences in order to be compatible with the GS-Junior sequencing technology. Amplifications were performed with Phusion[®] High-Fidelity DNA Polymerase (New England Biolabs) according to the following program: DNA was denatured 40 s at 98°C and then submitted to 38 cycles consisting of 98°C for 10 s, 68°C for 30 s and 72°C for 30 s, and 1 cycle at 72°C for 10 min. PCR products were first purified using NucleoSpin kit (Macherey-Nagel) followed by Ampure bead purification (Beckman Coulter). PCR products were subjected to "PCR emulsion step" (GS Junior+ emPCR Kit (Lib-A), Roche) and sequenced using GS Junior sequencing kit XL+ (Roche) according to the manufacturer's instructions. Raw sequences were aligned against reference sequences of *IgHJ₄*-downstream intron or *Smu* and only full length sequences were kept for mutation analysis. For *IgHJ₄*, clonally related sequences were removed based on the sequence of VDJ junction (*i.e.* CDR3) similarity. No further filtering steps were implemented in our analysis workflow. Mutations were called on each sequence using pairwise alignment algorithm (from biopython package) and only base substitutions were reported. Mutation frequencies were computed as the ratio between the sum of mutated bases in all complete sequences over the total number of aligned bases. For Ion Proton, sequencing libraries were prepared according to the user guide Ion Xpress[™] Plus gDNA Fragment Library Preparation (Cat. no. 4471269, Life Technologies). Briefly, PCR products (100ng) were fragmented by enzymatic digestion (Ion Shear[™] Plus Reagents Kit, Cat. no. 4471248) and ligated to Barcodes and Adapters (Ion Plus Fragment Library Kit, Cat. no. 4471252). After 200 bp size selection step on E-Gel precast agarose electrophoresis system, final amplification was performed. Raw data were processed using DeMinEr tool as described (28). In the case of studies performed in BER or MMR-deficient backgrounds of mixed 129Sv;C57BL/6 backgrounds, all SHM analysis were done by excluding nucleotides that differ between strains.

RT-PCR and q-PCR

Total RNA was prepared by using TRIzol reagent (Ambion) procedures. RNA samples were first treated with DNase I (Invitrogen) for 15 min at 25°C. RT was performed on 200 ng of total RNA with random hexamers or with specific primer (10μM) (sequence available in [Supplementary Figure S2.](#)) using superscript III enzyme (Invitrogen). As control, we performed a reverse transcription without primer to determine the threshold (referred as P[−] in bar graphs). Each real-time qPCR reaction was performed in duplicate on 10 ng of RNA equivalent, using TaqMan Universal (except for Sμ quantification we used SYBR green Mastermix (TAKARA)) on StepOnePlus system (Applied Biosystems). Primary transcription at *IgH* locus was quantified as previously described (37) and completed with both a set of primers and q-PCR probes close to *J_H* segments (listed in [Supplementary Figure 2.](#)) and a set of primers located 5' to Sμ: Smu-Fw (5'-ACCCAGGCTAAGAAGGCAAT-3'), Smu-Rev (5'-CCTTCCTTCTGCGTATCCAT-3'). Relative mRNA levels were normalized to *Gapdh* transcripts with the appropriate TaqMan probe (Mm99999915_g1, Applied Biosystem). Data were analyzed by comparing threshold cycle (*CT*) values according to the 2^{−(ΔΔ*CT*)}

^(ΔΔ*CT*) method. The *wt* mice templates used as calibrators were S2 for sense transcripts, AS0 or AS2 for antisense transcripts.

Statistical analysis

If not specified in the figure legend, Mann Whitney two-tailed tests were used for statistical analysis using GraphPad Prism software (**p*<0.05, ***p*<0.01, ****p*<0.001, *****p*<0.0001).

Data availability statement

The datasets presented in this study can be found in online repositories. The names of the repository/repositories and accession number(s) can be found below: <https://www.ebi.ac.uk/ena>, PRJEB52221.

Ethics statement

The animal study was reviewed and approved by Procédure de l'Enseignement Supérieur et Recherche autorisation APAFIS#16639-2018090612249522v2.

Author contributions

OAM, MT, MM, AG, MB, SB, CC, CB, JC, EP and SN performed experiments. EP and SN conceived and supervised the study. MM developed the experimental model. OAM, BV, PG, RM, EP and SN wrote the manuscript. All authors contributed to the article and approved the submitted version.

Funding

OM and MT were supported by PhD fellowship of the french Ministère de l'Enseignement Supérieur, de la Recherche et de de l'Innovation. This work was supported by Région Nouvelle Aquitaine, La Ligue Contre le Cancer (comités 87, 23 to EP and SN); the Fondation ARC pour la recherche sur le cancer (PJA 20181207918 to EP and PhD continuation fellowship to MT), Institut CARNOT CALYM, INCa-Cancéropôle GSO Emergence (to EP).

Acknowledgments

The authors are grateful to BISCEm unit (Univ. Limoges, UAR 2015 CNRS, US 42 Inserm, CHU Limoges) for technical support regarding DNA-RNA sequencing, microscopy, histology, cytometry, cell sorting and animal core facility. We are grateful to Drs. Fred Alt for providing *MARs_{Eμ}* targeting construct, Zéliha Oruc-Ratinaud and Tiffany Marchiol regarding animal health status. We thank Dominik Schenten, Sébastien Storck, Christophe Sirac, Laurent Delpy, Brice Laffleur, Alexis Saintamand and Jeanne Moreau for discussions and helpful comments. We are grateful to Michel Cogné for critical review of the manuscript.

Conflict of interest

The authors declare that the research was conducted in the absence of any commercial or financial relationships that could be construed as a potential conflict of interest.

Publisher's note

All claims expressed in this article are solely those of the authors and do not necessarily represent those of their affiliated organizations, or those of the publisher, the editors and the reviewers. Any product that may be evaluated in this article, or claim that may be made by its manufacturer, is not guaranteed or endorsed by the publisher.

Supplementary material

The Supplementary Material for this article can be found online at: <https://www.frontiersin.org/articles/10.3389/fimmu.2023.1030813/full#supplementary-material>

SUPPLEMENTARY FIGURE 1

Gating strategy to test developing B cells in mice. **(A)** Bone marrow B cell populations in *wt* and *MARs_{EU}^{Δ/Δ}* mice. Top row: B220+ CD117+ pre-pro B cells were stained with V450-anti-B220, PE-anti-CD117 Abs. Bottom row: B220+ CD43^{High} pro-B and B220+CD43^{Low} pre-B cell populations were stained with V450-anti-B220, FITC-anti-IgM, and PE-anti-CD43 Abs, gated on the IgM-negative population. **(B)** Splenic B cell subsets in *wt* and *MARs_{EU}^{Δ/Δ}* mice. Top row: CD21^{High} CD23^{Low} marginal zone and CD21^{Low} CD23^{High} follicular B cell populations were stained with V450-anti-B220, PE-anti-CD21 and FITC-anti-CD23 Abs, gated on B220+ population. Bottom row: IgM⁺IgD⁺ mature B cells were stained with V450-anti-B220, FITC-anti-IgD and PE-anti-IgM Abs. **(C)** Peritoneal cavity B cells in *wt* and *MARs_{EU}^{Δ/Δ}* mice. IgM+ CD5+ -B1a and IgM+ CD5- -B1b subsets were stained with V450-anti-B220, PE-anti-IgM, FITC-anti-CD5 Abs, gated on the B220+ population.

SUPPLEMENTARY FIGURE 2

SHM frequency within *J_H4* intron. **(A)** SHM downstream from *J_H3* and *J_H4* segments in Peyer's patch GC B cells sorted from *wt* and *MARs_{EU}^{Δ/Δ}* mice. For each genotype, pie charts represent distribution of mutated sequences (proportional to the area in each slice, data obtained by Sanger sequencing method) in individually recombined *IgH* alleles. Number of individual clones is reported in the center (after removal of clonally related sequences based on VDJ junction). Each pie chart represent SHM obtained from an individual experiment. Under each pie chart, SHM frequency, sequencing strategy and sample type (individual mice or pool) is indicated. Mean SHM frequency and p values are reported. **(B)** Bar graph displayed numbers of germinal center structures obtained in the spleen of *wt* and *MARs_{EU}^{Δ/Δ}* mice upon SRBC-immunization (left). Representative images of spleen section from immunized *wt* and *MARs_{EU}^{Δ/Δ}* animals (right) **(C)** Equivalent data representation than reported in **A** for SHM downstream from *J_H4* segments in splenic GC B cells sorted from SRBC-immunized *wt* and *MARs_{EU}^{Δ/Δ}* mice. Mean SHM frequency and p values are reported.

SUPPLEMENTARY FIGURE 3

SHM frequency downstream from *cEμ* region. **(A)** SHM downstream from *cEμ* region in Peyer's patch GC B cells sorted from *wt* and *MARs_{EU}^{Δ/Δ}* mice obtained by GS junior sequencing. For each genotype, pie charts represent distribution of mutated sequences (proportional to the area in each slice, data obtained by Sanger and GS Junior sequencing method) in individually recombined *IgH* alleles. Number of individual clones is reported in the center (after removal of clonally related sequences based on VDJ junction). Each pie chart represent SHM obtained from an individual experiment. Under each pie chart, SHM frequency, sequencing strategy and sample type (individual mice or pool) is

indicated. Mean SHM frequency and p values are reported. **(B)** Left: schematic representation of both *wt* and *MARs_{EU}^{Δ/Δ}* alleles to illustrate the distance between *cEμ* and *Sμ* region. Blue and red bars indicate the 473bp-designed region to quantify SHM at the same distance from *cEμ* in the two models. Right: Bar graph showing SHM frequency in the corresponding regions of *wt* and *MARs_{EU}^{Δ/Δ}* mice, the analysis was performed on samples described in **A**.

SUPPLEMENTARY FIGURE 4

Annotated nucleotide map of the *IgH-J_H1* to *Eμ* germline region from of 129 *wt* mice. All *J_H* exons as well as *coreEμ* element are indicated by bold characters. Start sites for antisense transcripts are reported as (*) according to the Alt study (38). Location of primers used for strand-specific reverse transcription (S1, S2, S3, AS0, AS1, AS2, AS3) are indicated by underlines. TaqMan qPCR amplicons (C, A, A') are highlighted in grey.

SUPPLEMENTARY FIGURE 5

Sense and antisense transcripts quantified with *IgH J_H3* and *J_H4* exons with additional TaqMan probes. **(A)** Murine *IgH* locus (not to scale) indicating location of primers (S1, S2, S3; black arrows) within introns downstream from *J_H3* and *J_H4* used for strand-specific reverse transcription to detect sense transcripts (dotted arrows). Black bars (A' and C) indicate location of q-PCR probes. Total primary transcripts and primary sense transcripts were quantified with A' and C probes in Peyer's patch GC B cells (dark colors) and *in vitro*-activated B cells (light colors) from *wt* and *MARs_{EU}^{Δ/Δ}* mice. **(B)** Murine *IgH* locus (not to scale) indicating location of primers (AS0, AS1, AS2, AS3; black arrows) within introns downstream from *J_H2*, *J_H3* and *J_H4* used for strand-specific reverse transcription to detect antisense transcripts (dotted arrows). Black bars (A' and C) indicate location of q-PCR probes. Primary antisense transcripts quantified with A' and C probes in Peyer's patch GC B cells (dark colors) and *in vitro*-activated B cells (light colors) from *wt* and *MARs_{EU}^{Δ/Δ}* mice. Dots indicated antisense transcripts start sites according to the Alt study (38). Baseline level was either provided by using a RT template performed without primers (P-) or using one strand-specific template that cannot be detected with the current probe (T-). p-value was determined with two tailed Mann Whitney test; significant differences are indicated by: *P<0.05; **P<0.01 and error bars represent SEM of two to three independent experiments.

SUPPLEMENTARY FIGURE 6

Sense and antisense transcription and expression in naive B cells. **(A)** IgH Sense (left bar graph) and antisense (right bar graph) transcripts quantified with A probe in naive B cells sorted from Peyer's patch in *wt* and *MARs_{EU}^{Δ/Δ}* mice. **(A)** Intracellular IgM mean fluorescence intensities measured by flow cytometry in naive B cells from Peyer's patches of *wt* and *MARs_{EU}^{Δ/Δ}* mice. **(C)** IgH sense (left bar graph) and antisense (right bar graph) transcripts quantified with A probe in resting splenic B cells sorted from *wt* and *MARs_{EU}^{Δ/Δ}* mice. Bar graphs show mean ± SEM of two independent experiments.

SUPPLEMENTARY FIGURE 7

Comparison of *in-vitro* Ig class switching in *wt* and *MARs_{EU}^{Δ/Δ}* mice. Percentage of IgG3 and IgG1 positive cells measured by flow cytometry after respectively LPS or LPS + IL4 stimulation for 3 days of splenic B cells sorted from *wt* and *MARs_{EU}^{Δ/Δ}* mice. Bar graphs show mean ± SEM of one representative experiment for each condition, gating strategy is indicated below.

SUPPLEMENTARY FIGURE 8

Base substitution patterns in BER- and MMR-deficient backgrounds. Comparison of SHM-related base substitution patterns, reported as frequencies, at *IgH* in Peyer's patch GC B cells sorted from *wt* and *MARs_{EU}^{Δ/Δ}* mice models, bred in genetic backgrounds deficient for base excision repair (*Ung^{Δ/Δ}*) and mismatch repair (*Msh2^{Δ/Δ}*). Data were obtained by NGS (Ion Proton) combined to DeMinEr filtering (28). **(A)** Substitution pattern downstream from *J_H4* in double-deficient *Ung^{Δ/Δ} Msh2^{Δ/Δ}* background. **(B)** Substitution pattern downstream from *J_H4* in DNA repair proficient (*Ung^{+/+} Msh2^{+/+}*) background. Relative proportions of transitions and transversions at dC/dG pairs are reported in an additional bar graph. **(C)** Substitution pattern downstream from *J_H4* in *Ung^{Δ/Δ}* background. **(D)** Substitution pattern downstream from *Iμ* in double-deficient *Ung^{Δ/Δ} Msh2^{Δ/Δ}* background. **(E)** Substitution pattern downstream from *Iμ* in DNA repair proficient (*Ung^{+/+} Msh2^{+/+}*) background. **(F)** Substitution pattern downstream from *Iμ* in *Ung^{Δ/Δ}* background. p-value was determined with two tailed Mann Whitney test; significant differences are indicated by: *P<0.05; **P<0.01 and error bars represent SEM of two to three independent experiments.

SUPPLEMENTARY TABLE 1

$MAR_{SE\mu}$ deletion led to normal B-lineage cell development. Bone Marrow and peripheral B cell subsets counts in *wt* and $MAR_{SE\mu}^{\Delta/\Delta}$ mice. Absolute numbers are reported as mean \pm SEM. Significance was assessed with Student T test. P value is indicated when difference is significant.

SUPPLEMENTARY TABLE 2

SHM data (NGS) from individual mice in DNA repair proficient background. Total number of mutations, total number of bp analyzed and mutation frequencies for *wt* and $MAR_{SE\mu}^{\Delta/\Delta}$ mice. (A) Data from intron 3' to J_H4 in Peyer's patches GC B cells, (B) Data from spleen GC B cells from SRBC-immunized mice, (C) Data from intron 3' to $I\mu$ in Peyer's patches GC B cells.

SUPPLEMENTARY TABLE 3

Unselected SHM within out of frame VDJ exons in GC B cells sorted from Peyer's patch. Unique VDJ junctions, rearranged to J_H3 and J_H4 segments, were obtained

after amplification, cloning and sequencing by classical Sanger method of DNA extracted from Peyer's patch sorted GC B cells ($n=2$ to 3 independent samples corresponding to individual mice or pools of 7 to 12 mice of each genotype). SHM data were calculated after processing individually recombined IgH alleles by IMG T V-Quest software (https://www.imgt.org/IMG_T_vquest); numbers of base substitutions identified as SHM by the software in the FR3 and CDR3 regions are reported in the table and were used to calculate SHM frequencies.

SUPPLEMENTARY TABLE 4

SHM data (NGS) from individual mice in genetic backgrounds deficient for base excision repair (*Ung*-deficient) and mismatch repair (*Msh2*-deficient). Total number of mutations, total number of bp analyzed and mutation frequencies. (A) Data from intron 3' to J_H4 in Peyer's patches GC B cells of $Ung^{\Delta/\Delta} Msh2^{\Delta/\Delta}$ and $Ung^{\Delta/\Delta} Msh2^{\Delta/\Delta} MAR_{SE\mu}^{\Delta/\Delta}$ mice, (B) Data from $Ung^{\Delta/\Delta}$ and $Ung^{\Delta/\Delta} MAR_{SE\mu}^{\Delta/\Delta}$ mice, (C) Data from intron 3' to $I\mu$ in Peyer's patches GC B cells of $Ung^{\Delta/\Delta} Msh2^{\Delta/\Delta}$ and $Ung^{\Delta/\Delta} Msh2^{\Delta/\Delta} MAR_{SE\mu}^{\Delta/\Delta}$ mice, (D) Data from $Ung^{\Delta/\Delta}$ and $Ung^{\Delta/\Delta} MAR_{SE\mu}^{\Delta/\Delta}$ mice.

References

- Perlot T, Alt FW. Cis-regulatory elements and epigenetic changes control genomic rearrangements of the IgH locus. *Adv Immunol* (2008) 99:1–32. doi: 10.1016/S0065-2776(08)00601-9
- Scheuermann RH, Garrard WT. MARs of antigen receptor and co-receptor genes. *Crit Rev Eukaryot Gene Expr* (1999) 9:295–310. doi: 10.1615/CritRevEukaryotGeneExpr.v9i3-4.140
- Gluch A, Vidakovic M, Bode J. Scaffold/matrix attachment regions (S/MARs): relevance for disease and therapy. *Handb Exp Pharmacol* (2008), 186:67–103. doi: 10.1007/978-3-540-72843-6_4
- Teves SS, Henikoff S. DNA Torsion as a feedback mediator of transcription and chromatin dynamics. *Nucleus* (2014) 5:211–8. doi: 10.4161/nucl.29086
- Pommier Y, Sun Y, Huang S-YN, Nitiss JL. Roles of eukaryotic topoisomerases in transcription, replication and genomic stability. *Nat Rev Mol Cell Biol* (2016) 17:703–21. doi: 10.1038/nrm.2016.111
- Cockerill PN, Yuen MH, Garrard WT. The enhancer of the immunoglobulin heavy chain locus is flanked by presumptive chromosomal loop anchorage elements. *J Biol Chem* (1987) 262:5394–7. doi: 10.1016/S0021-9258(18)61200-1
- Perlot T, Alt FW, Bassing CH, Suh H, Pinaud E. Elucidation of IgH intronic enhancer functions via germ-line deletion. *Proc Natl Acad Sci USA* (2005) 102:14362–7. doi: 10.1073/pnas.0507090102
- Afshar R, Pierce S, Bolland DJ, Corcoran A, Oltz EM. Regulation of IgH gene assembly: role of the intronic enhancer and 5'DQ52 region in targeting DHJH recombination. *J Immunol* (2006) 176:2439–47. doi: 10.4049/jimmunol.176.4.2439
- Marquet M, Garot A, Bender S, Carrion C, Rouaud P, Lecardeur S, et al. The $\epsilon\mu$ enhancer region influences h chain expression and b cell fate without impacting IgVH repertoire and immune response *in vivo*. *J Immunol* (2014) 193:1171–83. doi: 10.4049/jimmunol.1302868
- Ronai D, Iglesias-Ussel MD, Fan M, Shulman MJ, Scharff MD. Complex regulation of somatic hypermutation by cis-acting sequences in the endogenous IgH gene in hybridoma cells. *Proc Natl Acad Sci USA* (2005) 102:11829–34. doi: 10.1073/pnas.0505449102
- Azuma T, Motoyama N, Fields LE, Loh DY. Mutations of the chloramphenicol acetyl transferase transgene driven by the immunoglobulin promoter and intron enhancer. *Int Immunol* (1993) 5:121–30. doi: 10.1093/intimm/5.2.121
- Giusti AM, Manser T. Hypermutation is observed only in antibody h chain V region transgenes that have recombined with endogenous immunoglobulin h DNA: implications for the location of cis-acting elements required for somatic mutation. *J Exp Med* (1993) 177:797–809. doi: 10.1084/jem.177.3.797
- Motoyama N, Miwa T, Suzuki Y, Okada H, Azuma T. Comparison of somatic mutation frequency among immunoglobulin genes. *J Exp Med* (1994) 179:395–403. doi: 10.1084/jem.179.2.395
- Bachl J, Wabl M. Enhancers of hypermutation. *Immunogenetics* (1996) 45:59–64. doi: 10.1007/s002510050167
- Lin MM, Green NS, Zhang W, Scharff MD. The effects of $\epsilon\mu$, 3'alpha (hs 1,2) and 3'kappa enhancers on mutation of an ig-VDJ-Cgamma2a ig heavy gene in cultured b cells. *Int Immunol* (1998) 10:1121–9. doi: 10.1093/intimm/10.8.1121
- Ronai D, Berru M, Shulman MJ. Variegated expression of the endogenous immunoglobulin heavy-chain gene in the absence of the intronic locus control region. *Mol Cell Biol* (1999) 19:7031–40. doi: 10.1128/MCB.19.10.7031
- Li F, Yan Y, Pieretti J, Feldman DA, Eckhardt LA. Comparison of identical and functional igh alleles reveals a nonessential role for $\epsilon\mu$ in somatic hypermutation and class-switch recombination. *J Immunol* (2010) 185:6049–57. doi: 10.4049/jimmunol.0902992
- Sakai E, Bottaro A, Davidson L, Sleckman BP, Alt FW. Recombination and transcription of the endogenous ig heavy chain locus is effected by the ig heavy chain intronic enhancer core region in the absence of the matrix attachment regions. *Proc Natl Acad Sci USA* (1999) 96:1526–31. doi: 10.1073/pnas.96.4.1526
- Kohwi-Shigematsu T, Maass K, Bode J. A thymocyte factor SATB1 suppresses transcription of stably integrated matrix-attachment region-linked reporter genes. *Biochemistry* (1997) 36:12005–10. doi: 10.1021/bi971444j
- Wang Z, Goldstein A, Zong RT, Lin D, Neufeld EJ, Scheuermann RH, et al. Cux/CDP homeoprotein is a component of NF- μ NR and represses the immunoglobulin heavy chain intronic enhancer by antagonizing the bright transcription activator. *Mol Cell Biol* (1999) 19:284–95. doi: 10.1128/MCB.19.1.284
- Kaplan MH, Zong RT, Herrscher RF, Scheuermann RH, Tucker PW. Transcriptional activation by a matrix associating region-binding protein. Contextual requirements for the function of bright. *J Biol Chem* (2001) 276:21325–30. doi: 10.1074/jbc.M100836200
- Wiersma EJ, Ronai D, Berru M, Tsui FW, Shulman MJ. Role of the intronic elements in the endogenous immunoglobulin heavy chain locus. either the matrix attachment regions or the core enhancer is sufficient to maintain expression. *J Biol Chem* (1999) 274:4858–62. doi: 10.1074/jbc.274.8.4858
- Goyenechea B, Kliks N, Yelamos J, Williams GT, Riddell A, Neuberger MS, et al. Cells strongly expressing ig(kappa) transgenes show clonal recruitment of hypermutation: a role for both MAR and the enhancers. *EMBO J* (1997) 16:3987–94. doi: 10.1093/emboj/16.13.3987
- Yi M, Wu P, Trevorrow KW, Clafin L, Garrard WT. Evidence that the igkappa gene MAR regulates the probability of premature V-J joining and somatic hypermutation. *J Immunol* (1999) 162:6029–39. doi: 10.4049/jimmunol.162.10.6029
- Franklin A, Blanden RV. Hypothesis: biological role for J-c intronic matrix attachment regions in the molecular mechanism of antigen-driven somatic hypermutation. *Immunol Cell Biol* (2005) 83:383–91. doi: 10.1111/j.1440-1711.2005.01327.x
- Inlay MA, Gao HH, Odegard VH, Lin T, Schatz DG, Xu Y. Roles of the ig kappa light chain intronic and 3' enhancers in igk somatic hypermutation. *J Immunol* (2006) 177:1146–51. doi: 10.4049/jimmunol.177.2.1146
- Rada C, Gupta SK, Gherardi E, Milstein C. Mutation and selection during the secondary response to 2-phenylloxazalone. *Proc Natl Acad Sci U.S.A.* (1991) 88:5508–12. doi: 10.1073/pnas.88.13.5508
- Martin OA, Garot A, Le Noir S, Aldigier J-C, Cogné M, Pinaud E, et al. Detecting rare AID-induced mutations in b-lineage oncogenes from high-throughput sequencing data using the detection of minor variants by error correction method. *J Immunol* (2018) 201:950–6. doi: 10.4049/jimmunol.1800203
- Alamyar E, Duroux P, Lefranc M-P, Giudicelli V. IMG T^(®) tools for the nucleotide analysis of immunoglobulin (IG) and T cell receptor (TR) V-(D)-J repertoires, polymorphisms, and IG mutations: IMG T/V-QUEST and IMG T/HighV-QUEST for NGS. *Methods Mol Biol* (2012) 882:569–604. doi: 10.1007/978-1-61779-842-9_32
- Lennon GG, Perry RP. C mu-containing transcripts initiate heterogeneously within the IgH enhancer region and contain a novel 5'-nontranslatable exon. *Nature* (1985) 318:475–8. doi: 10.1038/318475a0
- Petersen S, Casellas R, Reina-San-Martin B, Chen HT, Difilippantonio MJ, Wilson PC, et al. AID is required to initiate Nbs1/gamma-H2AX focus formation and mutations at sites of class switching. *Nature* (2001) 414:660–5. doi: 10.1038/414660a
- Nagaoka H, Muramatsu M, Yamamura N, Kinoshita K, Honjo T. Activation-induced deaminase (AID)-directed hypermutation in the immunoglobulin smu region: Implication of AID involvement in a common step of class switch recombination and somatic hypermutation. *J Exp Med* (2002) 195:529–34. doi: 10.1084/jem.20012144
- Heltzel JHM, Maul RW, Yang W, Gearhart PJ. Promoter proximity defines mutation window for VH and VK genes rearranged to different J genes. *J Immunol* (2022), 208:2220–2226. doi: 10.4049/jimmunol.2101002
- Sakai E, Bottaro A, Alt FW. The ig heavy chain intronic enhancer core region is necessary and sufficient to promote efficient class switch recombination. *Int Immunol* (1999) 11:1709–13. doi: 10.1093/intimm/11.10.1709

35. Xue K, Rada C, Neuberger MS. The *in vivo* pattern of AID targeting to immunoglobulin switch regions deduced from mutation spectra in *msh2^{-/-} ung^{-/-}* mice. *J Exp Med* (2006) 203:2085–94. doi: 10.1084/jem.20061067
36. Fukita Y, Jacobs H, Rajewsky K. Somatic hypermutation in the heavy chain locus correlates with transcription. *Immunity* (1998) 9:105–14. doi: 10.1016/S1074-7613(00)80592-0
37. Tinguely A, Chemin G, Pèron S, Sirac C, Reynaud S, Cogné M, et al. Cross talk between immunoglobulin heavy-chain transcription and RNA surveillance during b cell development. *Mol Cell Biol* (2012) 32:107–17. doi: 10.1128/MCB.06138-11
38. Perlot T, Li G, Alt FW. Antisense transcripts from immunoglobulin heavy-chain locus V(D)J and switch regions. *Proc Natl Acad Sci USA* (2008) 105:3843–8. doi: 10.1073/pnas.0712291105
39. Bolland DJ, Wood AL, Johnston CM, Bunting SF, Morgan G, Chakalova L, et al. Antisense intergenic transcription in V(D)J recombination. *Nat Immunol* (2004) 5:630–7. doi: 10.1038/ni1068
40. Zhao Y, Dunn-Walters DK, Barone F, Spencer J. Antisense transcripts of V(D)J rearrangements; artifacts caused by false priming? *Mol Immunol* (2009) 46:2357–62. doi: 10.1016/j.molimm.2009.03.020
41. Li W, Notani D, Rosenfeld MG. Enhancers as non-coding RNA transcription units: recent insights and future perspectives. *Nat Rev Genet* (2016) 17:207–23. doi: 10.1038/nrg.2016.4
42. Laffleur B, Basu U, Lim J. RNA Exosome and non-coding RNA-coupled mechanisms in AID-mediated genomic alterations. *J Mol Biol* (2017) 429:3230–3241. doi: 10.1016/j.jmb.2016.12.021
43. Lim J, Giri PK, Kazadi D, Laffleur B, Zhang W, Grinstein V, et al. Nuclear proximity of Mtr4 to RNA exosome restricts DNA mutational asymmetry. *Cell* (2017) 169:523–537.e15. doi: 10.1016/j.cell.2017.03.043
44. Laffleur B, Lim J, Zhang W, Chen Y, Pefanis E, Bizarro J, et al. Noncoding RNA processing by DIS3 regulates chromosomal architecture and somatic hypermutation in b cells. *Nat Genet* (2021) 53:230–42. doi: 10.1038/s41588-020-00772-0
45. Rada C, Di Noia JM, Neuberger MS. Mismatch recognition and uracil excision provide complementary paths to both ig switching and the A/T-focused phase of somatic mutation. *Mol Cell* (2004) 16:163–71. doi: 10.1016/j.molcel.2004.10.011
46. Shen HM, Tanaka A, Bozek G, Nicolae D, Storb U. Somatic hypermutation and class switch recombination in *Msh6^{-/-}Ung^{-/-}* double-knockout mice. *J Immunol* (2006) 177:5386–92. doi: 10.4049/jimmunol.177.8.5386
47. Liu M, Duke JL, Richter DJ, Vinuesa CG, Goodnow CC, Kleinstein SH, et al. Two levels of protection for the b cell genome during somatic hypermutation. *Nature* (2008) 451:841–5. doi: 10.1038/nature06547
48. Feng Y, Li C, Stewart JA, Barbulescu P, Seija Desivo N, Álvarez-Quilón A, et al. FAM72A antagonizes UNG2 to promote mutagenic repair during antibody maturation. *Nature* (2021) 600:324–8. doi: 10.1038/s41586-021-04144-4
49. Rogier M, Moritz J, Robert I, Lescale C, Heyer V, Abello A, et al. Fam72a enforces error-prone DNA repair during antibody diversification. *Nature* (2021) 600:329–33. doi: 10.1038/s41586-021-04093-y
50. Lebecque SG, Gearhart PJ. Boundaries of somatic mutation in rearranged immunoglobulin genes: 5' boundary is near the promoter, and 3' boundary is approximately 1 kb from V(D)J gene. *J Exp Med* (1990) 172:1717–27. doi: 10.1084/jem.172.6.1717
51. Shen HM, Storb U. Activation-induced cytidine deaminase (AID) can target both DNA strands when the DNA is supercoiled. *Proc Natl Acad Sci USA* (2004) 101:12997–3002. doi: 10.1073/pnas.0404974101
52. Wright BE, Schmidt KH, Davis N, Hunt AT, Minnick MF. II. correlations between secondary structure stability and mutation frequency during somatic hypermutation. *Mol Immunol* (2008) 45:3600–8. doi: 10.1016/j.molimm.2008.05.012
53. Kobayashi M, Sabouri Z, Sabouri S, Kitawaki Y, Pommier Y, Abe T, et al. Decrease in topoisomerase I is responsible for activation-induced cytidine deaminase (AID)-dependent somatic hypermutation. *Proc Natl Acad Sci USA* (2011) 108:19305–10. doi: 10.1073/pnas.1114522108
54. Maul RW, Saribasak H, Cao Z, Gearhart PJ. Topoisomerase I deficiency causes RNA polymerase II accumulation and increases AID abundance in immunoglobulin variable genes. *DNA Repair (Amst)* (2015) 30:46–52. doi: 10.1016/j.dnarep.2015.03.004
55. Kodgire P, Mukkavar P, Ratnam S, Martin TE, Storb U. Changes in RNA polymerase II progression influence somatic hypermutation of ig-related genes by AID. *J Exp Med* (2013) 210:1481–92. doi: 10.1084/jem.20121523
56. Maul RW, Cao Z, Venkataraman L, Giorgetti CA, Press JL, Denizot Y, et al. Spt5 accumulation at variable genes distinguishes somatic hypermutation in germinal center b cells from ex vivo-activated cells. *J Exp Med* (2014) 211:2297–306. doi: 10.1084/jem.20131512
57. Kohler KM, McDonald JJ, Duke JL, Arakawa H, Tan S, Kleinstein SH, et al. Identification of core DNA elements that target somatic hypermutation. *J Immunol* (2012) 189:5314–26. doi: 10.4049/jimmunol.1202082
58. Tarsalainen A, Maman Y, Meng F-L, Kyläniemi MK, Soikkeli A, Budzyńska P, et al. Ig enhancers increase RNA polymerase II stalling at somatic hypermutation target sequences. *J Immunol* (2022) 208:143–54. doi: 10.4049/jimmunol.2100923
59. Meng F-L, Du Z, Federation A, Hu J, Wang Q, Kieffer-Kwon K-R, et al. Convergent transcription at intragenic super-enhancers targets AID-initiated genomic instability. *Cell* (2014) 159:1538–48. doi: 10.1016/j.cell.2014.11.014
60. Basu U, Meng F-L, Keim C, Grinstein V, Pefanis E, Eccleston J, et al. The RNA exosome targets the AID cytidine deaminase to both strands of transcribed duplex DNA substrates. *Cell* (2011) 144:353–63. doi: 10.1016/j.cell.2011.01.001
61. Pefanis E, Wang J, Rothschild G, Lim J, Chao J, Rabadan R, et al. Noncoding RNA transcription targets AID to divergently transcribed loci in b cells. *Nature* (2014) 514:389–93. doi: 10.1038/nature13580
62. Kaur S, Coulombe Y, Ramdzan ZM, Leduy L, Masson J-Y, Nepveu A. Special AT-rich sequence-binding protein 1 (SATB1) functions as an accessory factor in base excision repair. *J Biol Chem* (2016) 291:22769–80. doi: 10.1074/jbc.M116.735696
63. Pinaud E, Khamlichi AA, Le Morvan C, Drouet M, Nalesso V, Le Bert M, et al. Localization of the 3' IgH locus elements that effect long-distance regulation of class switch recombination. *Immunity* (2001) 15:187–99. doi: 10.1016/S1074-7613(01)00181-9
64. Rouaud P, Vincent-Fabert C, Saintamand A, Fiancette R, Marquet M, Robert I, et al. The IgH 3' regulatory region controls somatic hypermutation in germinal center b cells. *J Exp Med* (2013) 210:1501–7. doi: 10.1084/jem.20130072

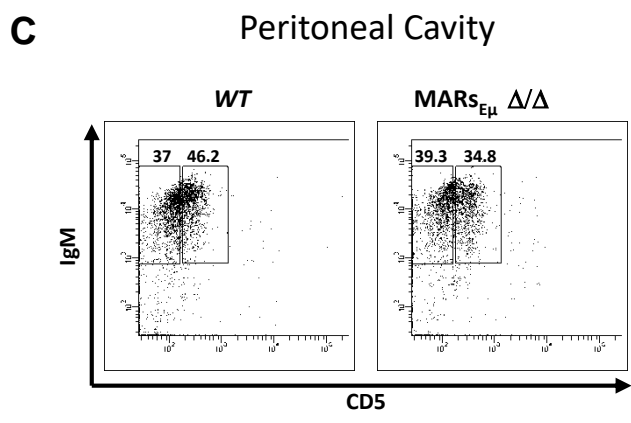
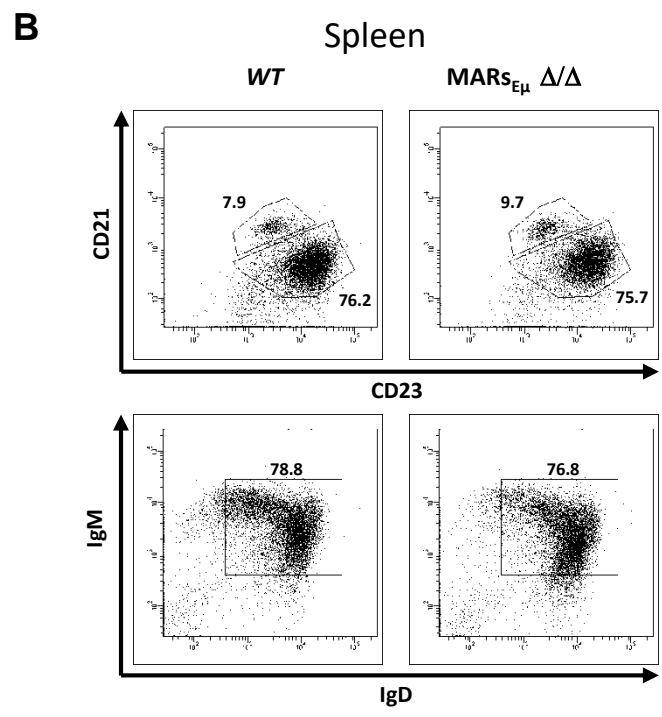
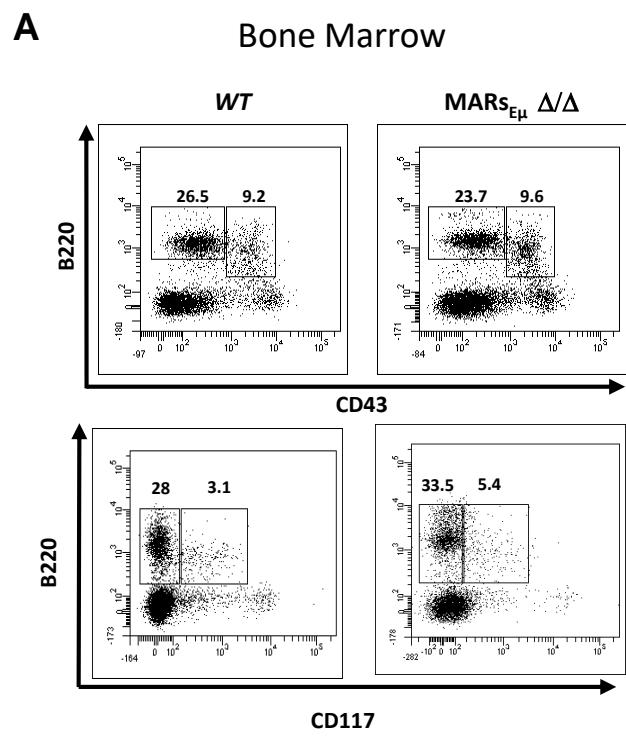

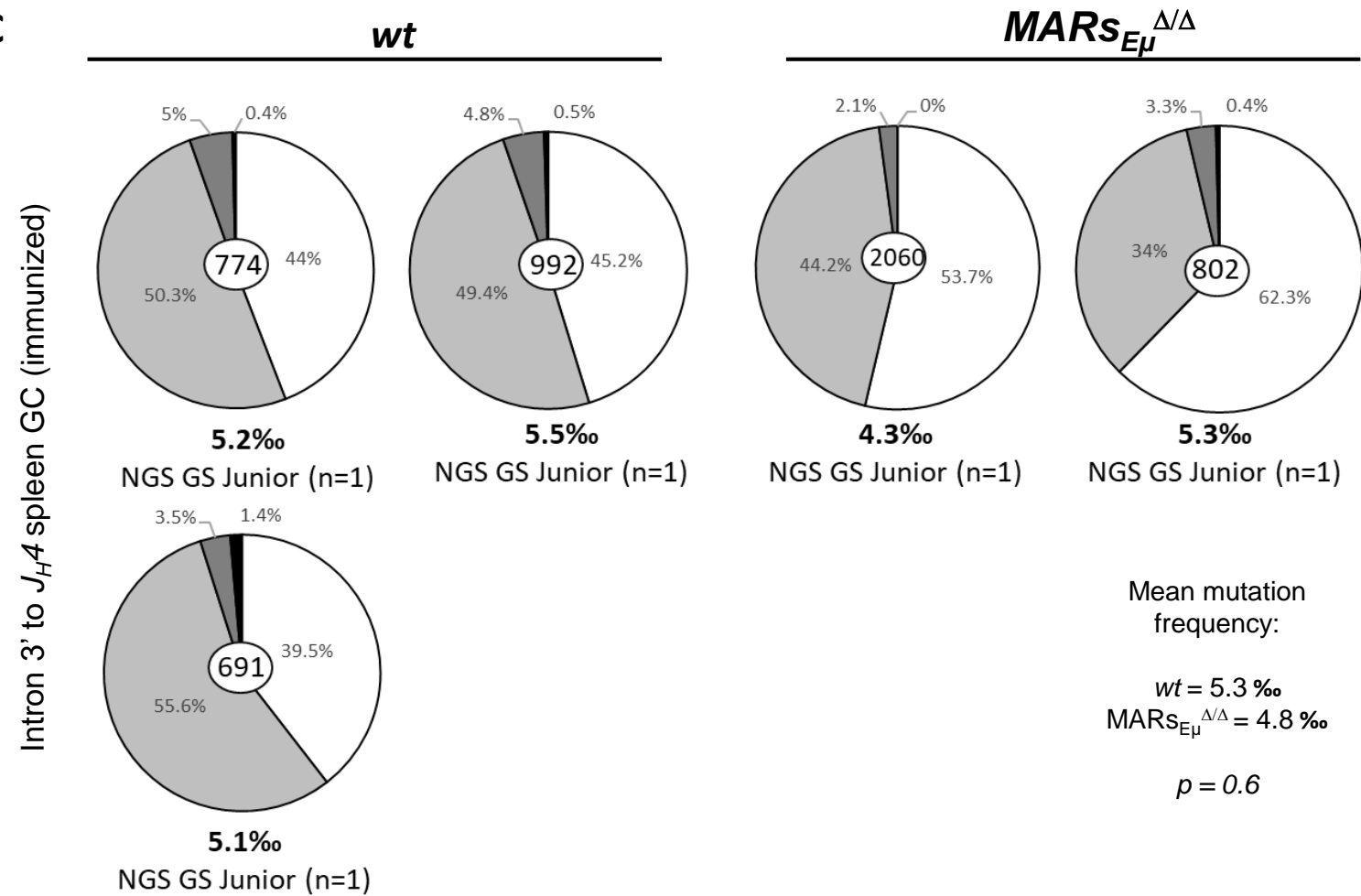
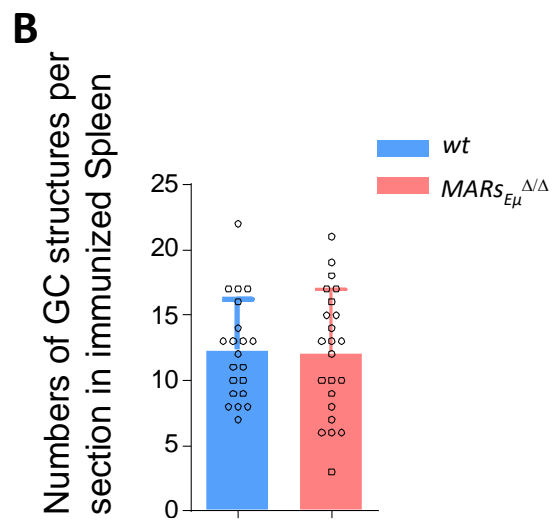
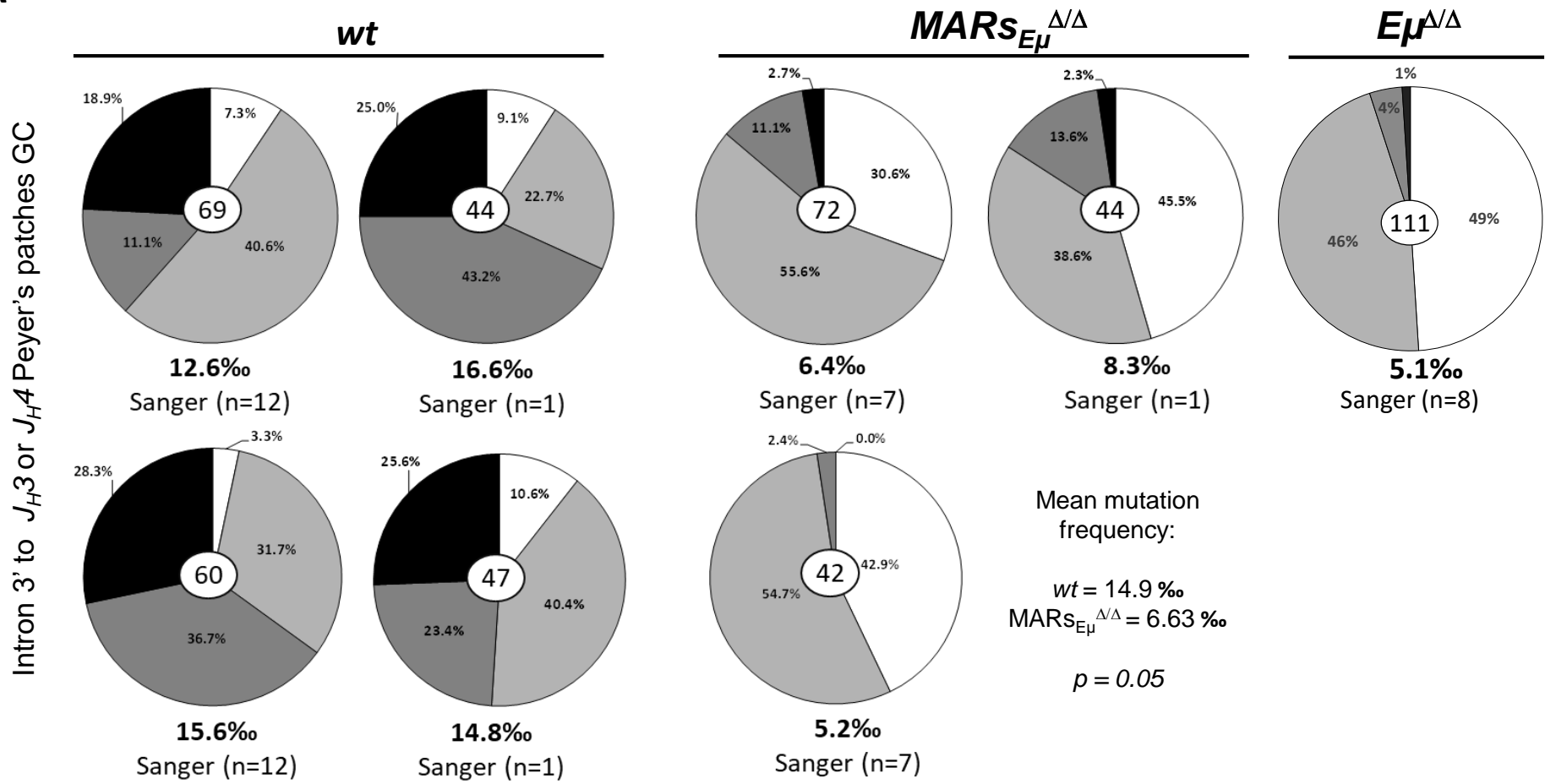

Mutation per sequence

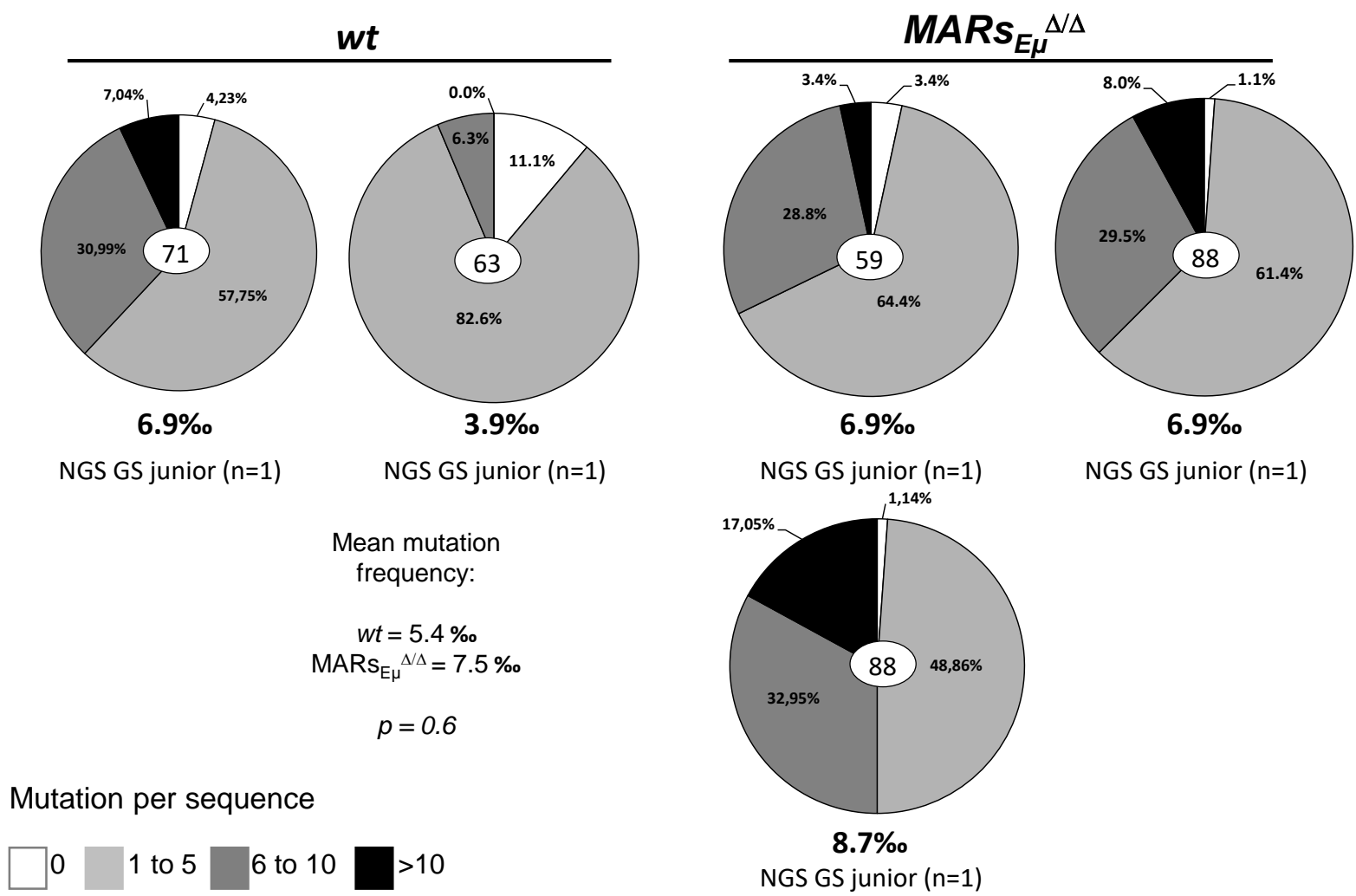
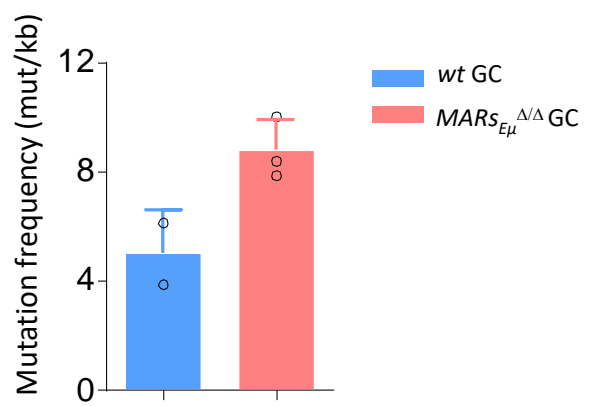
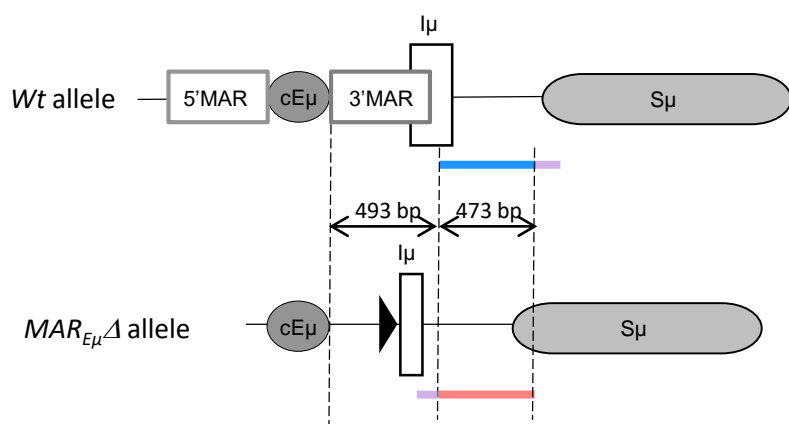

AIntron 5' to *Smu* Peyer's patch GC**B**

J_H1

ctactggtacttgcgatgtctgggggcgcagggaccacggtcaccgtctcctcaggtaagctggcttttttctttctgca
*
attccattctgaaatgggaaaagatattctcagatctccccatgtcaggccatctgccacactctgcatgctgcagaag
*
cttttctgtaaggataggggtcttcactcccaggaaaagaggcagtcagaggctagctgcctgtggaacagtgacaatca
*
tggaatataggcatttacattggttaggctacatgggtagatgggtttttgtacaccactaaaggggtctatgatagt
tg

J_H2

actactttgactactggggccaaggcaccactctcacagtctcctcaggtgagtccttacaacctctctcttctattca
* * * * *
gcttaaataagattttactgcatgttgggggggaaatgtgtgtatctgaatttcagggtcatgaaggactagggacacc
ttgggagtcagaaaggggtcattgggagccctggctgatgcagacagacatcctcagctcccagacttcatggccagaga
AS0
tttatagggatcctggccagcattgccgctaggtccctctcttctatgctttctttgtccctcactggcctccatctga
gataatcctggagccctagccaaggatcatttattgtcaggggtctaatacattgttgtcacaatgtg

J_H3

cctggtttgcttactggggccaagggactctgggtcactgtctctgcaggtgagtcctaacttctcccattctaaatgca
* C
tgttggggggattctgagccttcaggaccaagattctctgcaaacgggaatcaagattcaaccctttgtcccaaagtt
* * *
gagacatgggtctgggtcagggactctctgcctgctggtctgtggtgacattagaactgaagtatgatgaaggatctgc
cagaactgaagcttgaagtctgaggcagaatcctgtccagggtctatcggactcttgtgagaattaggggctgacagtt
gatggtgacaatttcagggtcagtgactgtctgggttctctgaggtgaggctggaatatagggtcaccttgaagactta
AS1
gaggggtccagggggcttctgcacaggcagggaaacagaatgtggaacaatgacttgaatgggttattcttgtgtgacac
caggaattggcataatgtctgagttgccaggggtgattctagtcagactctggggttttgtcgggtatagaggaaa
atccactattgtg

J_H4

attactatgctatggactactggggtaaggaacctcagtcaccgtctcctcaggtaagaatggcctctccagggtctt
* * * * * AS2
atttttaacctttggttatggagtttctgagcattgcagactaatcttggatatttgtccctgagggagccggctgaga
* * A AS3
gaagttgggaaataaactgtctagggatctcagagcctttaggacagattatctccacatctttgaaaaactaagaatc
* S1 * * * * *
tgtgtgatggtggtggagtccttgatgatgggatagggactttggaggctcatttgaggagatgctaaaacaat
A'
cctatggctggagggatagttggggctgtagttggagattttccagtttttagaataaaagtattagctgcggaatatac
*
ttcaggaccacctctgtgacagcatttatacagtatccgatgcatagggacaaagagtggagtggggcactttcttttag
*
atltgtgaggaatgttccacactagattgtttaaaacttcatttgttggaggagagctgtcttagtgattgagtcaag
*
ggagaaaggcatctagcctcgggtctcaaaagggtagttgctg
S2

5' MAR

tctagagaggtctggtggagcctgcaaaagtccagctttcaaaggaacacagaagtatgtgtatggaatattagaagat
gttgcttttactcttaagttggttcctaggaataatagttaaatactgtgactttaaaatgtgagaggggttttcaagta
ctcatttttttaaatgtccaaaatttttgtcaatcaatttgaggcttgtttgtgtagaactgacattacttaaagttt
aaccgaggaatgggagtgaggctctctcataccctattcagaactgacttttaacaataataaattaagtttaaaatat
ttttaaatgaattgagcaatggtgagttggagtc

Core E_μ

aagatggccgatcagaaccagaacacctgcagcagctggcaggaagcaggtcatgtggcaaggctatttggggaaggga
S3
aaataaaaccactaggtaaacttgtagctgtggtttgaagaagtggttttgaaacactctgtccagccccaccaaacg
aaagtccaggctgagcaaaacaccacctgggtaatttgcatttctaaaataagttgag

3' MAR

gattcagccgaaactggagaggtcctcttttaacttattgagttcaaccttttaatttttagcttgagtagttctagttt
ccccaaacttaagtttatcgacttcaaaatgtatttagaattcattttcaaaattagggtatgtaagaaattgaaggac
tttagtgcttttaatttctaataatatttagaaaacttcttaaaatactctattatttctccctctgattattgggtctc
cattcaattcttttccaatacccgaagcatttacagtgactttgttcatgatcttttttagttgtttgtttgccttac
tattaagactttgacattctggtcaaaacggcttcacaaatctttttcaagaccactttctgagattcattttaggag
aaataacttttttttaaatgaatgcaattatctaga

A Sense transcripts

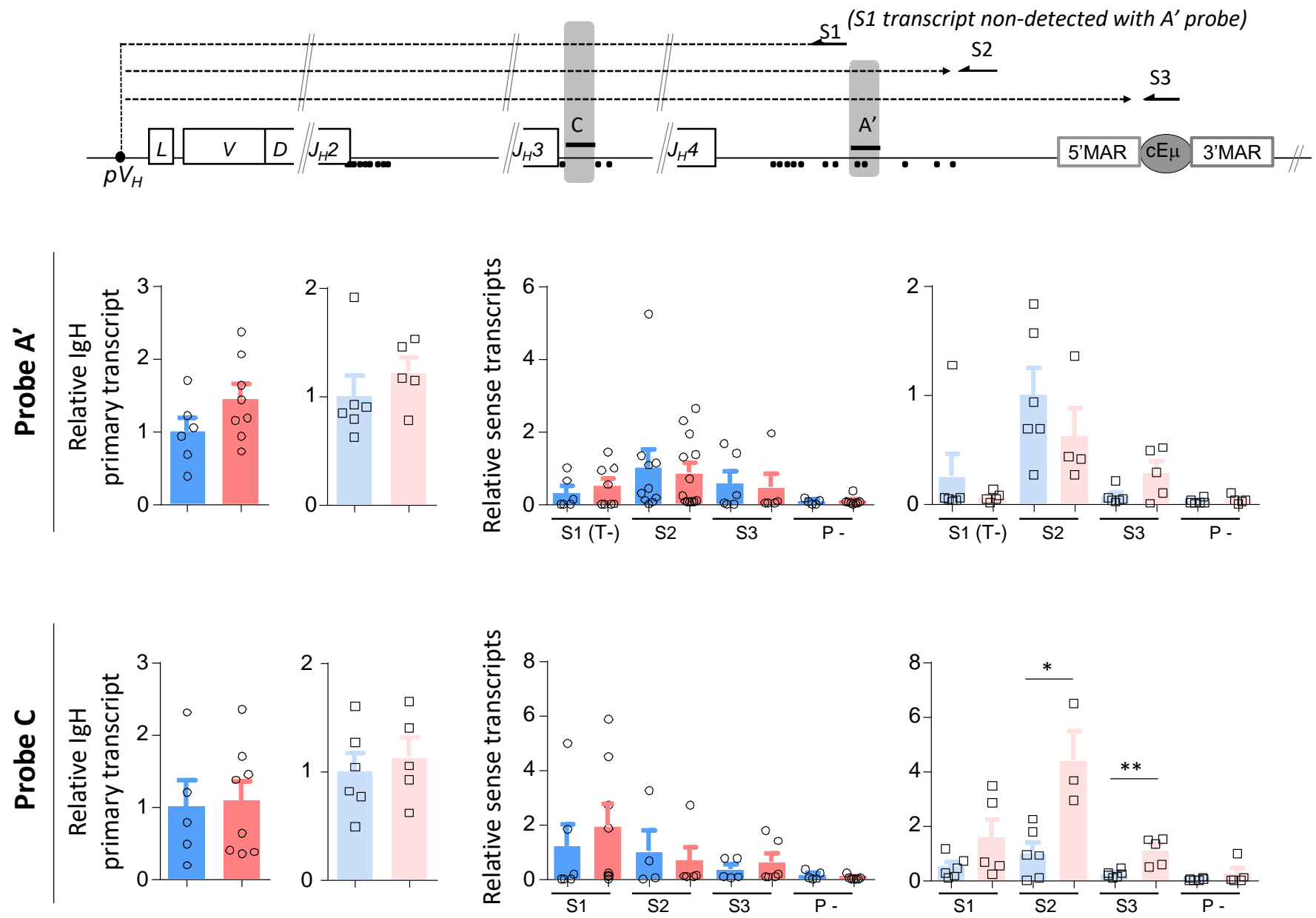

B Antisense transcripts

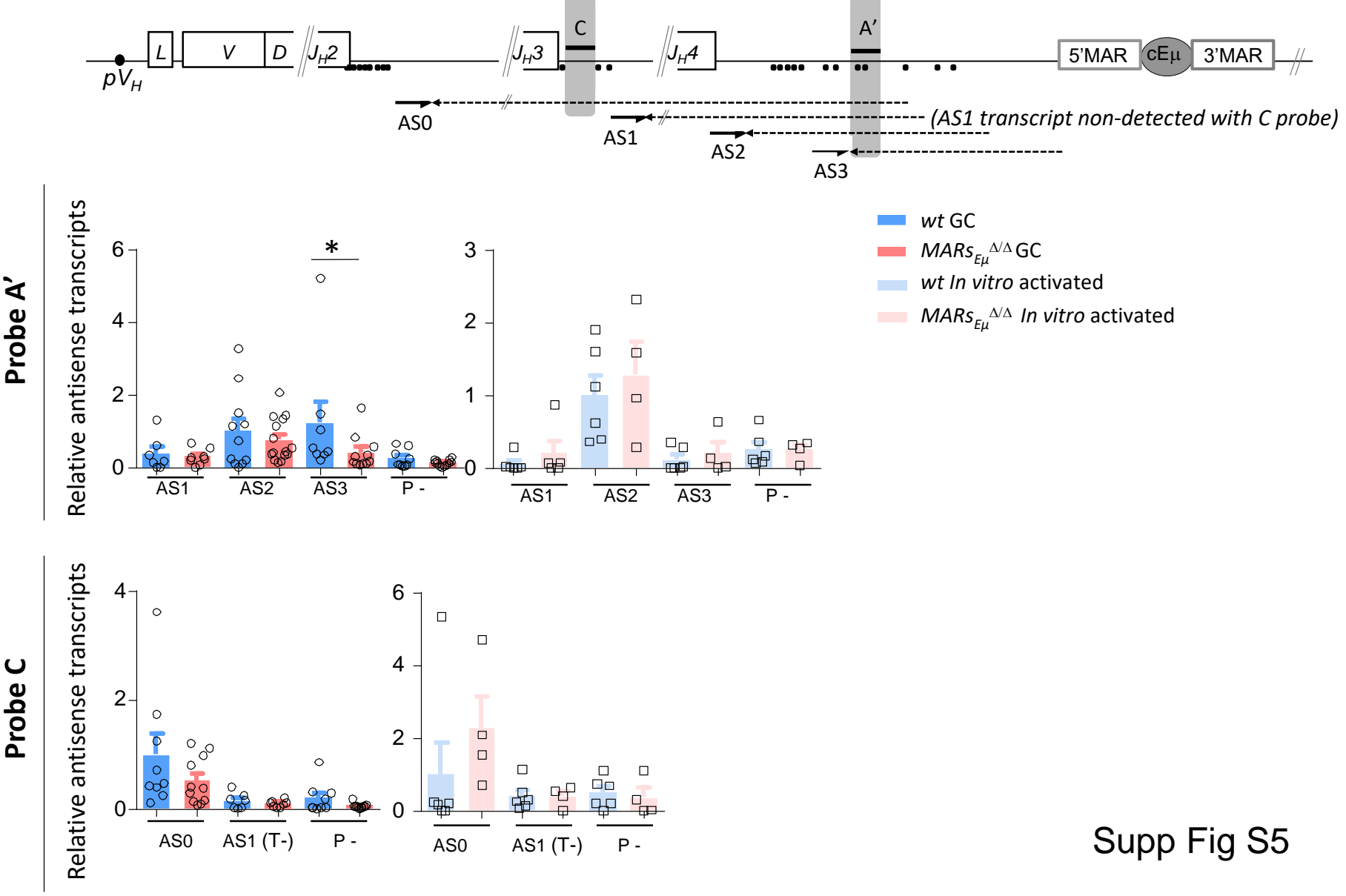

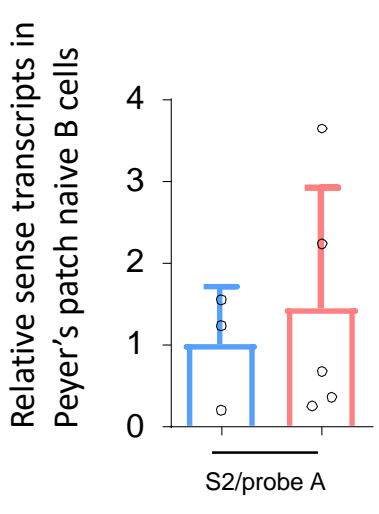
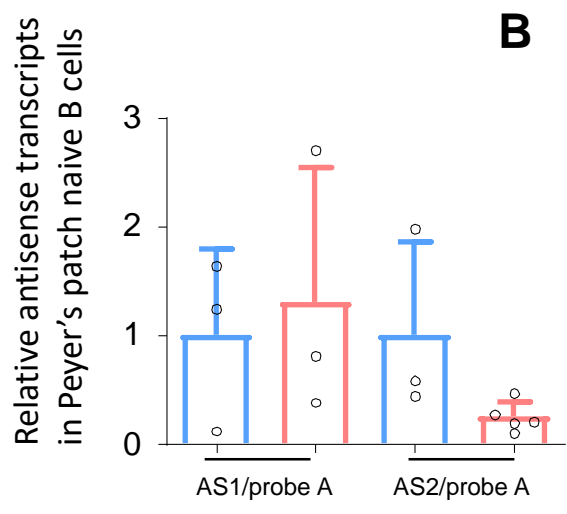
A**B**

Intracellular IgM
Mean Fluorescence Intensity in naive B cells from Peyers patches

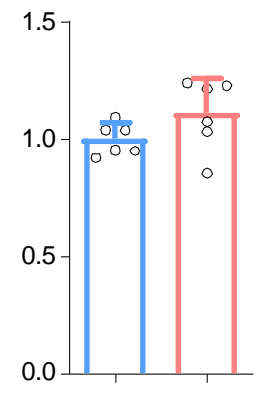
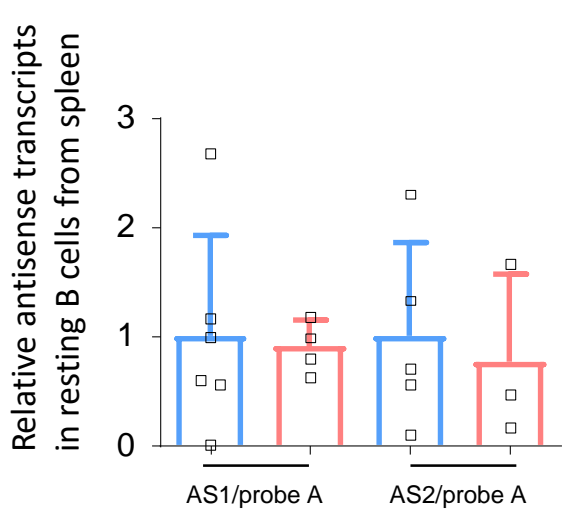
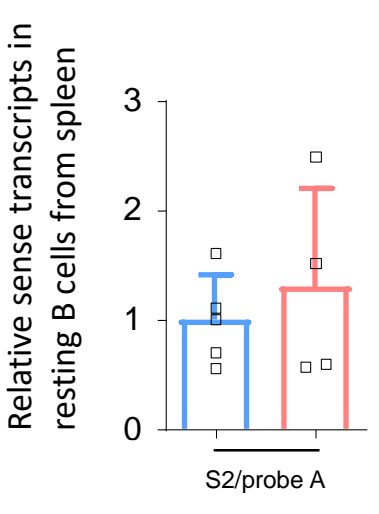
**C**

wt
 $MARS_{E\mu}^{\Delta/\Delta}$

Supp Fig S6

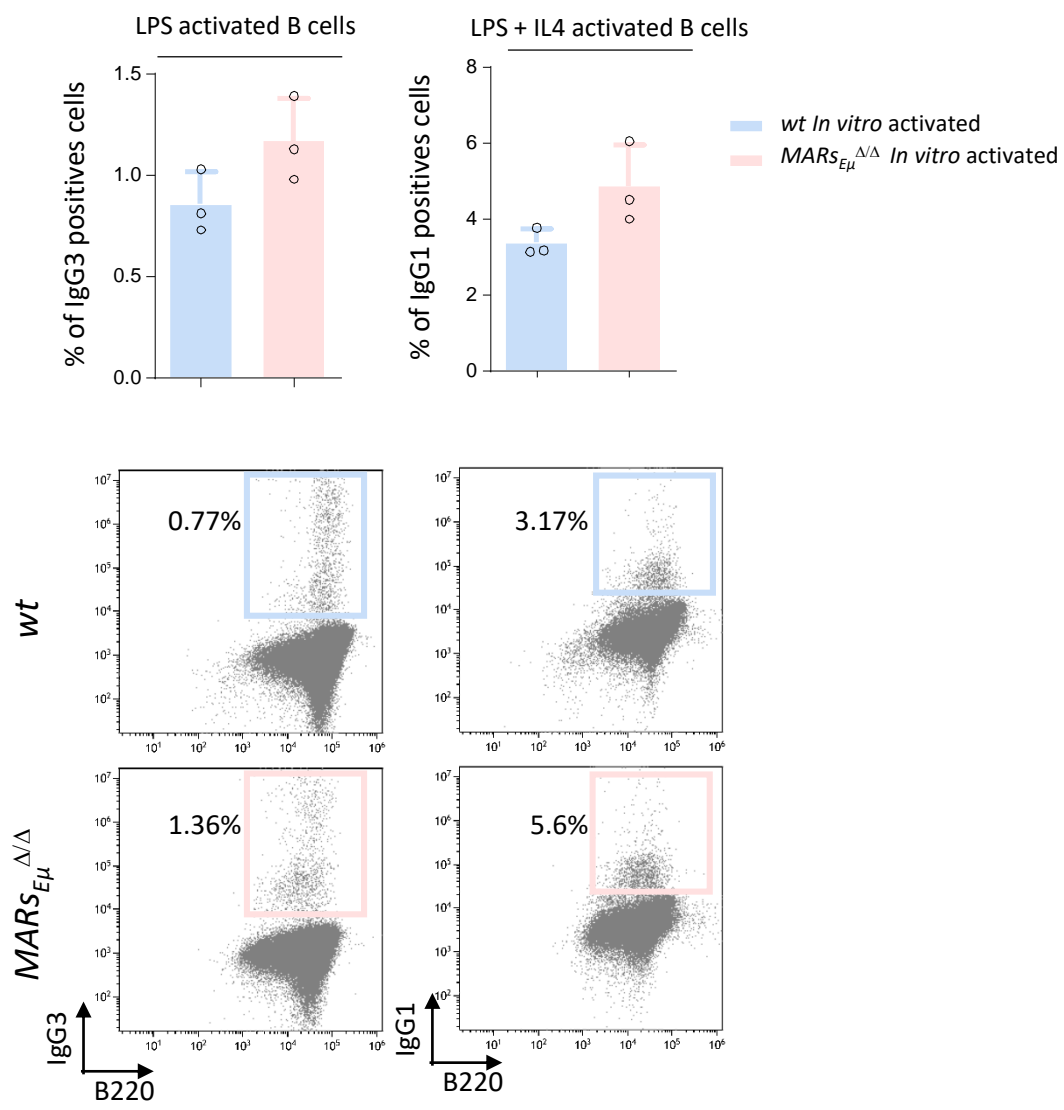

Supp Fig S7

Intron 3' to J_H4

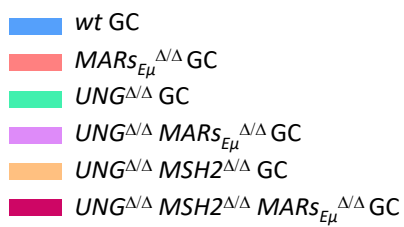
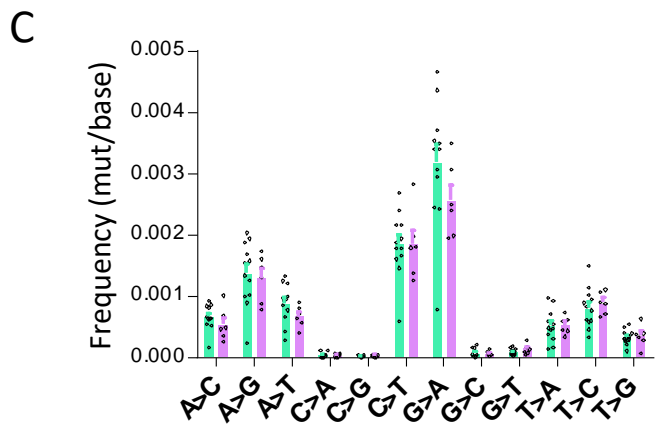
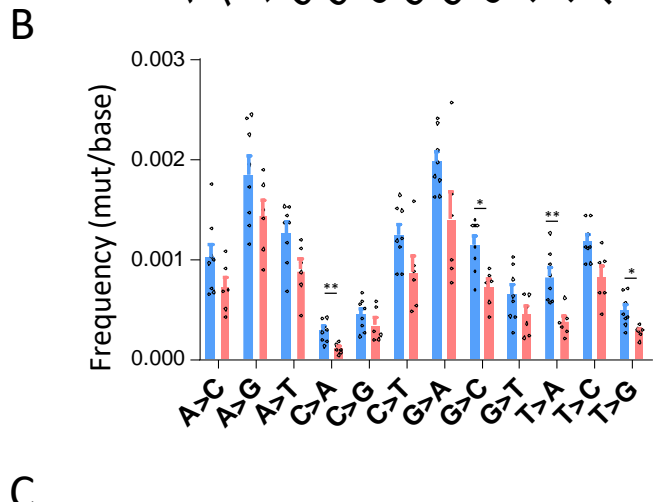
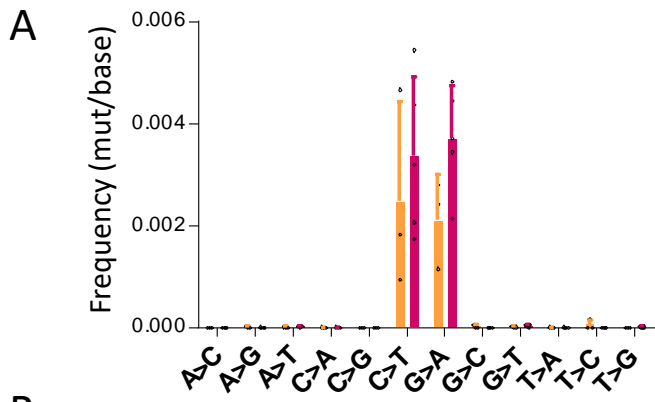

Intron 5' to Smu

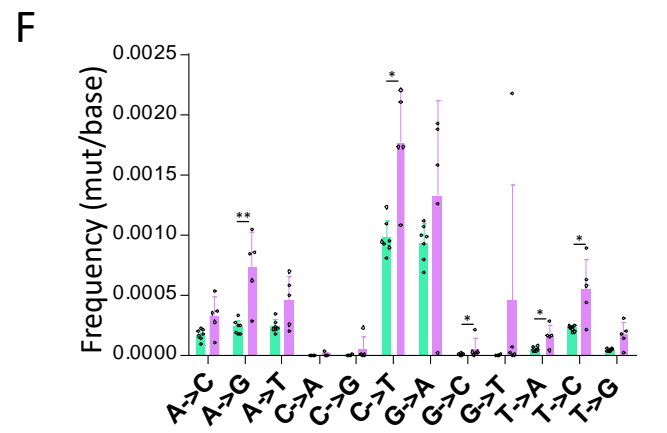
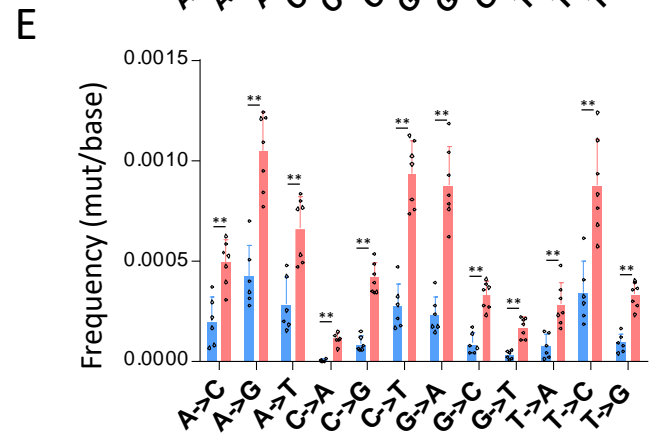
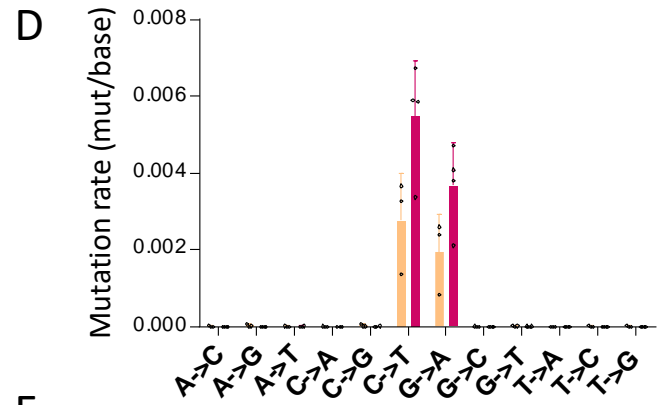

Supp Fig S8

Supplementary Table S1

| | <i>wt</i> Cell numbers (x10 ⁶) | <i>MARs_{Eμ}^{Δ/Δ}</i> Cell numbers (x10 ⁶) | Significance |
|--|---|--|--------------|
| Bone marrow | | | |
| B-lineage cells (B220 ⁺) | 84.96 ± 3.326 N=5 | 75.27 ± 4.241 N=6 | NS |
| Pre-pro B cells (B220 ⁺ /CD117 ⁺) | 2.183 ± 0.1974 N=6 | 2.567 ± 0.2951 N=6 | NS |
| Pro-B cells (IgM ⁻ /B220 ⁺ /CD43 ^{high}) | 7.380 ± 1.131 N=6 | 7.050 ± 0.9949 N=6 | NS |
| Pre-B cells (IgM ⁻ /B220 ⁺ /CD43 ^{low}) | 12.50 ± 1.965 N=6 | 13.54 ± 2.203 N=6 | NS |
| Spleen | | | |
| B-lineage cells (B220 ⁺) | 58.16 ± 4.593 N=6 | 70.68 ± 3.524 N=6 | NS |
| Naïve mature B cells (B220 ⁺ /IgM ⁺ /IgD ⁺) | 45.09 ± 3.145 N=6 | 52.76 ± 1.874 N=5 | NS |
| Marginal zone B cells (B220 ⁺ /CD21 ^{high} /CD23 ^{low}) | 7.235 ± 1.504 N=6 | 7.740 ± 0.5829 N=6 | NS |
| Follicular B cells (B220 ⁺ /CD21 ^{low} /CD23 ^{high}) | 42.01 ± 3.506 N=6 | 45.75 ± 2.992 N=6 | NS |
| Peritoneal cavity | | | |
| B-lineage cells (B220 ⁺) | 1.864 ± 0.3514 N=5 | 2.517 ± 0.2998 N=5 | NS |
| B1a cells (CD5 ⁺ /IgM ⁺) | 0.5924 ± 0.1002 N=5 | 0.8280 ± 0.1308 N=5 | NS |
| B1b cells (CD5 ⁻ /IgM ⁺) | 1.076 ± 0.2745 N=5 | 1.474 ± 0.2010 N=5 | NS |
| Peyer's patches | | | |
| B-lineage cells (B220 ⁺) | 4.765 ± 1.106 N=6 | 5.841 ± 1.172 N=6 | NS |
| B220 ⁺ /IgA ⁺ cells | 0.5625 ± 0.1273 N=6 | 0.8837 ± 0.2218 N=6 | NS |
| B220 ⁺ /IgM ⁺ cells | 2.828 ± 0.5269 N=6 | 3.782 ± 0.8263 N=6 | NS |
| Naive B cells (B220 ⁺ /PNA ^{low} /Fas ^{low}) | 3.684 ± 0.6369 N=5 | 3.556 ± 0.5026 N=5 | NS |
| Germinal centre B cells (B220 ⁺ /PNA ^{high} /Fas ^{high}) | 1.044 ± 0.8822 N=8 | 3.258 ± 1.2 N=11 | P=0.0007 |

Supplementary Table S2

A

| Intron 3' to J ^{H4} Peyer's patch GC | | | | | | |
|---|---------------------|-----------------------------|-------------------------|---------------------------|-----------------------------|-------------------------|
| # of individual mice | wt mice | | | MARSEμ ^{ΔΔ} mice | | |
| | number of mutations | total number of bp analyzed | Frequency (mutation/Kb) | number of mutation | total number of bp analyzed | Frequency (mutation/Kb) |
| #1 | 5 919 179 | 434 026 896 | 13.6 | 1 835 118 | 193 099 971 | 9.5 |
| #2 | 1 381 154 | 127 267 013 | 10.9 | 3 217 763 | 388 192 563 | 8.3 |
| #3 | 7 063 941 | 539 404 010 | 13.1 | 1 224 927 | 230 604 186 | 5.3 |
| #4 | 2 213 918 | 148 184 470 | 14.9 | 4 215 306 | 354 052 562 | 11.9 |
| #5 | 4 027 597 | 378 109 299 | 10.7 | 1 974 487 | 210 307 731 | 9.4 |
| #6 | 1 402 298 | 123 363 043 | 11.4 | 1 429 132 | 250 627 288 | 5.7 |
| #7 | 2 498 967 | 182 824 193 | 13.7 | | | |
| #8 | 2 105 343 | 208 395 146 | 10.1 | | | |
| Total | 26 612 397 | 2 141 574 070 | 12.4 | 13 896 733 | 1 626 884 301 | 8.5 |

B

| Intron 3' to J ^{H4} spleen GC (Immunized) | | | | | | |
|--|---------------------|-----------------------------|-------------------------|---------------------------|-----------------------------|-------------------------|
| # of individual mice | wt mice | | | MARSEμ ^{ΔΔ} mice | | |
| | number of mutations | total number of bp analyzed | Frequency (mutation/Kb) | number of mutation | total number of bp analyzed | Frequency (mutation/Kb) |
| #1 | 8 799 | 1 416 237 | 6.2 | 5 535 | 3 257 438 | 1.7 |
| #2 | 5 285 | 1 173 359 | 4.5 | 31 896 | 13 027 215 | 2.5 |
| #3 | 59 657 | 19 245 534 | 3.1 | 482 | 501 374 | 1.0 |
| Total | 73 741 | 21 835 130 | 3.4 | 37 913 | 16 786 027 | 2.3 |

C

| Intron 3' to Imu Peyer's patches GC | | | | | | |
|-------------------------------------|---------------------|-----------------------------|-------------------------|---------------------------|-----------------------------|-------------------------|
| # of individual mice | wt mice | | | MARSEμ ^{ΔΔ} mice | | |
| | number of mutations | total number of bp analyzed | Frequency (mutation/Kb) | number of mutation | total number of bp analyzed | Frequency (mutation/Kb) |
| #1 | 48604 | 35 947 796 | 1.4 | 340 669 | 70 101 915 | 4.9 |
| #2 | 42 937 | 32 953 275 | 1.3 | 1 098 398 | 215 265 958 | 5.1 |
| #3 | 59 309 | 28 156 682 | 2.1 | 530 553 | 94 311 231 | 5.6 |
| #4 | 17 594 | 11 681 044 | 1.5 | 241790 | 32530038 | 7.4 |
| #5 | 11 901 | 3231298 | 3.7 | 192 502 | 23871828 | 8.1 |
| #6 | 27 566 | 9864502 | 2.8 | 117 229 | 16868982 | 6.9 |
| #7 | | | | 343 232 | 44846733 | 7.7 |
| Total | 207 911 | 121 834 597 | 1.7 | 2 864 373 | 497 796 685 | 5.8 |

Supplementary Table S3

| | # of unique rearrangement analyzed | SHM in FR3 (downstream from VHJ558 consensus primer, defined by IMGT V-Quest) | | | SHM in CDR3 (end of rearranged-VH segment, defined by IMGT V-Quest) | | | SHM in FR3+CDR3 | | |
|--|------------------------------------|---|--------------------|--------------------------|---|--------------------|--------------------------|------------------|--------------------|--------------------------|
| | | # of nt analyzed | # of substitutions | SHM frequency (#mut/kbp) | # of nt analyzed | # of substitutions | SHM frequency (#mut/kbp) | # of nt analyzed | # of substitutions | SHM frequency (#mut/kbp) |
| Non-productive rearrangements to JH3 or JH4 in WT mice (n=3 samples) | 38 | 1438 | 36 | 25.03 | 187 | 14 | 74.87 | 1582 | 50 | 31.60 |
| Non-productive rearrangements to JH3 or JH4 in MARS _{Eμ} KO mice (n=2 samples) | 25 | 924 | 20 | 21.64 | 123 | 8 | 65.04 | 1047 | 28 | 26.74 |

Supplementary Table S4

A

| Intron 3' to JH4 Peyer's patch GC | | | | | | |
|-----------------------------------|---|-----------------------------|-------------------------|---|-----------------------------|-------------------------|
| # of individual mice | UNG ^{Δ/Δ} MSH2 ^{Δ/Δ} mice | | | UNG ^{Δ/Δ} MSH2 ^{Δ/Δ} MARSEμ ^{Δ/Δ} mice | | |
| | number of mutations | total number of bp analyzed | Frequency (mutation/Kb) | number of mutation | total number of bp analyzed | Frequency (mutation/Kb) |
| #1 | 83 489 | 39 010 041 | 2.1 | 165 311 | 42 503 695 | 3.9 |
| #2 | 542 601 | 70 241 171 | 7.7 | 94 241 | 16 931 788 | 5.6 |
| #3 | 206 309 | 48 590 092 | 4.2 | 512 031 | 57 470 681 | 8.9 |
| #4 | | | | 1 041 060 | 149 775 567 | 7 |
| #5 | | | | 718 875 | 69 661 668 | 10.3 |
| Total | 832 399 | 157 841 304 | 5.3 | 2 531 518 | 336 343 399 | 7.5 |

B

| Intron 3' to JH4 Peyer's patch GC | | | | | | |
|-----------------------------------|-------------------------|-----------------------------|-------------------------|---|-----------------------------|-------------------------|
| # of individual mice | UNG ^{Δ/Δ} mice | | | UNG ^{Δ/Δ} MARSEμ ^{Δ/Δ} mice | | |
| | number of mutations | total number of bp analyzed | Frequency (mutation/Kb) | number of mutation | total number of bp analyzed | Frequency (mutation/Kb) |
| #1 | 272 454 | 26839331 | 10.2 | 613 978 | 89 213 320 | 6.9 |
| #2 | 1 798 561 | 145965068 | 12.3 | 473 338 | 44 306 794 | 10.7 |
| #3 | 432 270 | 160149949 | 2.7 | 441 712 | 67 366 607 | 6.6 |
| #4 | 633 350 | 90533829 | 7 | 569 070 | 65 436 018 | 8.7 |
| #5 | 507 031 | 47228276 | 10.7 | 817 177 | 73 685 315 | 11.1 |
| #6 | 99 600 | 9066959 | 10.9 | 744 638 | 79 286 350 | 9.4 |
| #7 | 208 684 | 19274286 | 10.8 | | | |
| #8 | 258 678 | 34545602 | 7.5 | | | |
| #9 | 318 557 | 30156482 | 10.6 | | | |
| #10 | 1 576 407 | 163649903 | 9.6 | | | |
| #11 | 2 822 217 | 195113384 | 14.5 | | | |
| #12 | 563 458 | 56197886 | 10 | | | |
| Total | 9 491 267 | 978 720 955 | 9.7 | 3 659 913 | 419 294 404 | 8.7 |

C

| Intron 3' to Imu Peyer's patches GC | | | | | | |
|-------------------------------------|---|-----------------------------|-------------------------|---|-----------------------------|-------------------------|
| # of individual mice | UNG ^{Δ/Δ} MSH2 ^{Δ/Δ} mice | | | UNG ^{Δ/Δ} MSH2 ^{Δ/Δ} MARSEμ ^{Δ/Δ} mice | | |
| | number of mutations | total number of bp analyzed | Frequency (mutation/Kb) | number of mutation | total number of bp analyzed | Frequency (mutation/Kb) |
| #1 | 78 467 | 34 863 085 | 2.3 | 64 593 | 11 768 040 | 5.5 |
| #2 | 117 529 | 19 114 688 | 6.2 | 794 845 | 81 456 430 | 9.8 |
| #3 | 4 285 | 698 559 | 6.1 | 829 374 | 83 165 361 | 10 |
| #4 | | | | 394 268 | 34 269 808 | 11.5 |
| Total | 200 281 | 54 676 332 | 3.7 | 2 083 080 | 210 659 639 | 9.9 |

D

| Intron 3' to Imu Peyer's patches GC | | | | | | |
|-------------------------------------|-------------------------|-----------------------------|-------------------------|---|-----------------------------|-------------------------|
| # of individual mice | UNG ^{Δ/Δ} mice | | | UNG ^{Δ/Δ} MARSEμ ^{Δ/Δ} mice | | |
| | number of mutations | total number of bp analyzed | Frequency (mutation/Kb) | number of mutation | total number of bp analyzed | Frequency (mutation/Kb) |
| #1 | 154 039 | 46 862 890 | 3.3 | 566 494 | 78 527 619 | 7.2 |
| #2 | 138624 | 45 368 381 | 3 | 944 483 | 141 666 058 | 6.7 |
| #3 | 102 015 | 41 553 443 | 2.5 | 680 364 | 210 922 293 | 3.2 |
| #4 | 155 773 | 63 882 794 | 2.4 | 91 352 | 11 480 275 | 8 |
| #5 | 301 513 | 106 673 675 | 2.8 | 429 016 | 81 539 599 | 5.3 |
| #6 | 431 266 | 144 210 474 | 3 | | | |
| #7 | 468 727 | 144 538 082 | 3.2 | | | |
| Total | 1 751 957 | 593 089 739 | 3 | 2 711 709 | 524 135 844 | 5.2 |