

Effects of microsecond pulsed plasma discharges on non-premixed swirling Biogas/Air flames



Ahlem Ghabi^{1,2}, Toufik Boushaki¹, Pablo Escot-Bocanegra², Eric Robert²

¹ ICARE UPR 3021, CNRS, 1C, Av. Recherche Scientifique, 45071 Orléans, France

² GREMI, UMR 7344, CNRS/Université d'Orléans, 14 rue d'Issoudun, 45067 Orléans, France

ahlem.ghabi@cnrs-orleans.fr

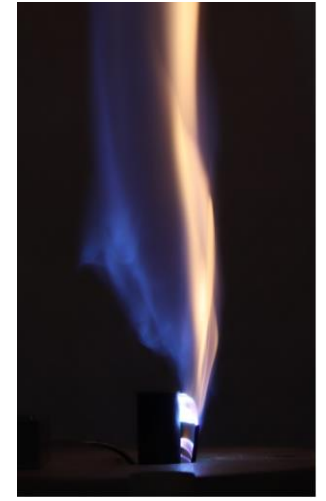

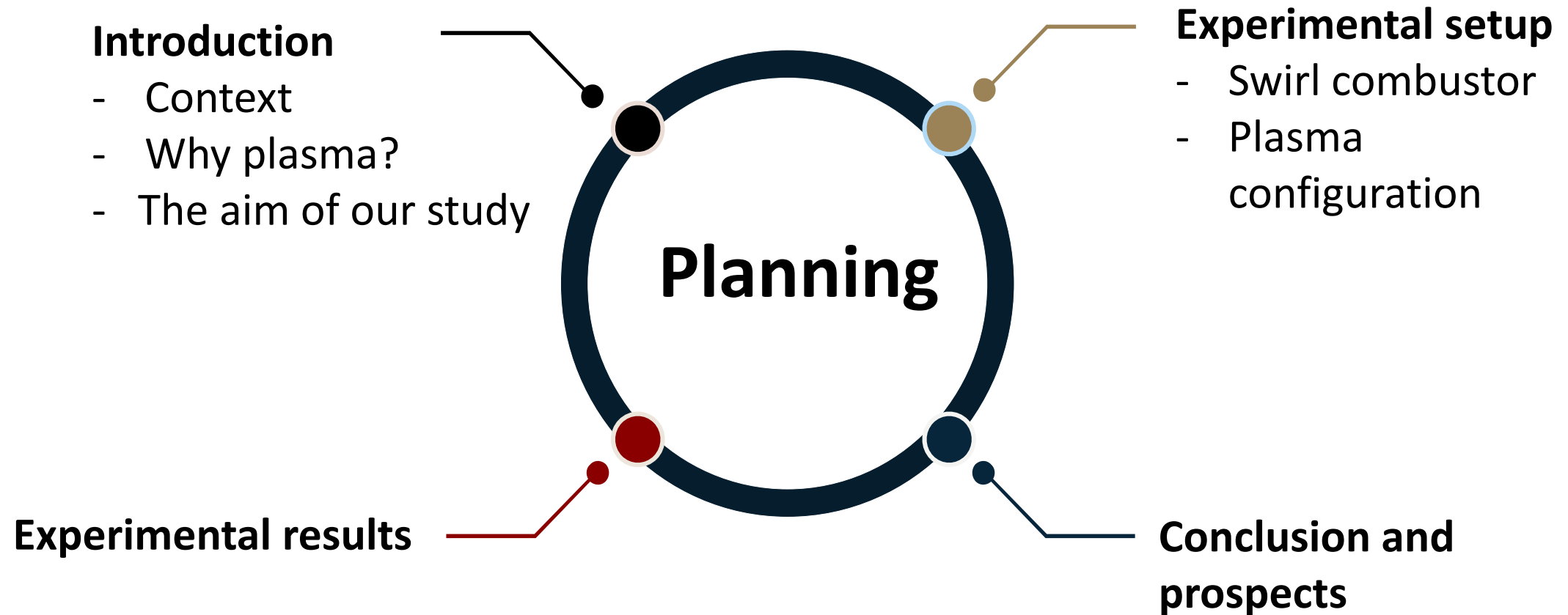

Context

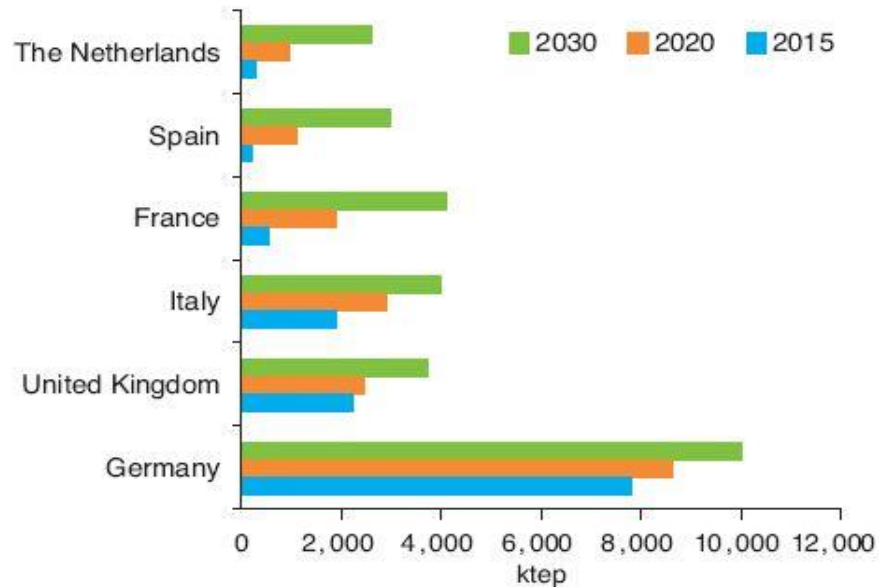

Source: IFPEN

Biogas development potential in Europe by 2030

Biogas: CH₄ (50-80%.vol); CO₂ (20-45%.vol) et N₂, O₂, H₂S et de NH₃ (<5%.vol).

Typical composition of dried raw biogas (from [Moletta 2015])

Unit Type	Agricultural	Wastewater treatment plant	Disclaimer (ISDND)	Industrial effluents	Household waste
CH ₄ (%)	50-60	60-70	35-65	60-80	64
CO ₂ (%)	40-50	30-40	15-50	20-40	35
Dinitrogen	?	0-0.2	5-40	0	1
Dioxygen (%)	0	0	0-5	0	0
H ₂ S (%)	0-0.001	0-0.4	0-0.003	0-2	?
Others (%)	0-0.01	0-0.01	0-0.01	0-0.01	0-0.01



Variability of the biogas mixture leads to

- Combustion instabilities
- Modification of the lift-off heights
- Increase of the pollutant emissions

The aim of our study

Investigate the effect of **microsecond pulsed plasma** for the active control of a **swirling biogas flame**.

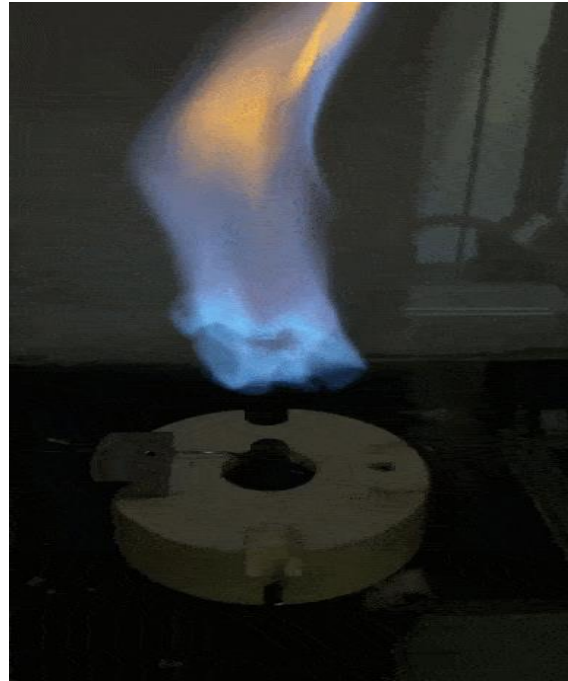

Gas + electrical discharge



Plasma



Reactive species
(radicals and excited molecules)/ **Heat**

- Electrical measurements
- Flame stability
- Pollutant emissions
- Emitted species

- Increase lean burn flame stability.
- Reduce pollutant emissions.

Combustion chamber



- This combustion chamber models an industrial furnace (or boiler).

Dimensions: 1.2 x 0.5 x 0.5 m³

Power: 30 kW

23 viewing windows

External water cooling

Insulating refractory inside walls

- The burner is placed at the bottom of the chamber which allows the flame to extend vertically along the combustion chamber.

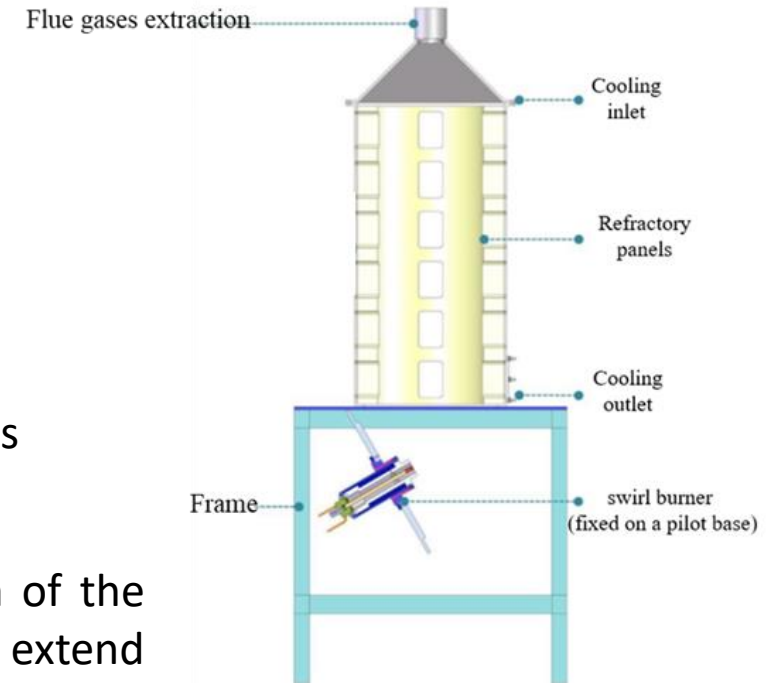

Coaxial swirl burner

The coaxial swirl burner contains:

- **Central tube:** directs the fuel (biogas/methane) to
- **Annular tube:** contains a swirler and supplies the oxidant flow

Swirler: placed in the annular tube and fixed at - 55 mm from the burner outlet surface. It contains 8 blades with orientations that depend on the required number of swirls.

Swirl number	R(mm)	Rh(mm)	$\alpha(^{\circ})$
Sn=0.5	17.5	8.8	

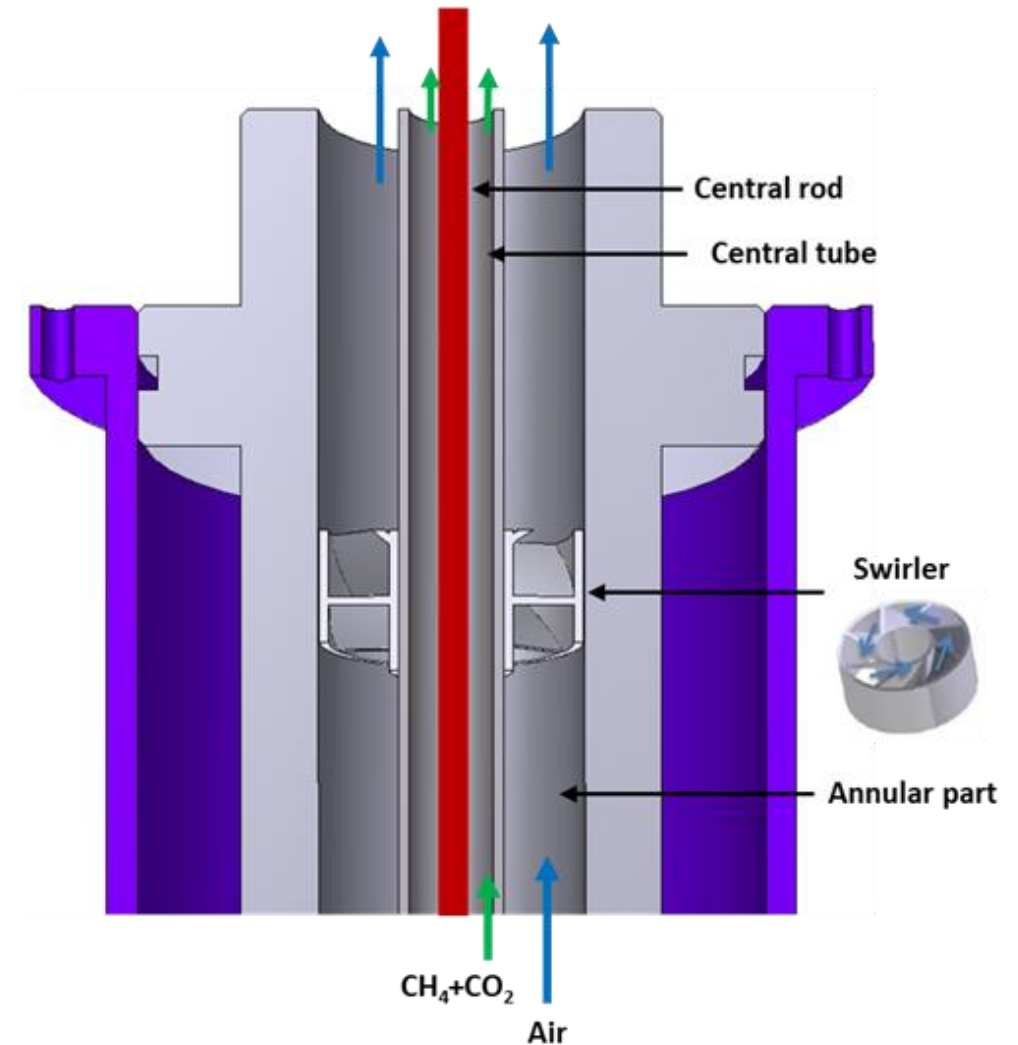

Measurement devices

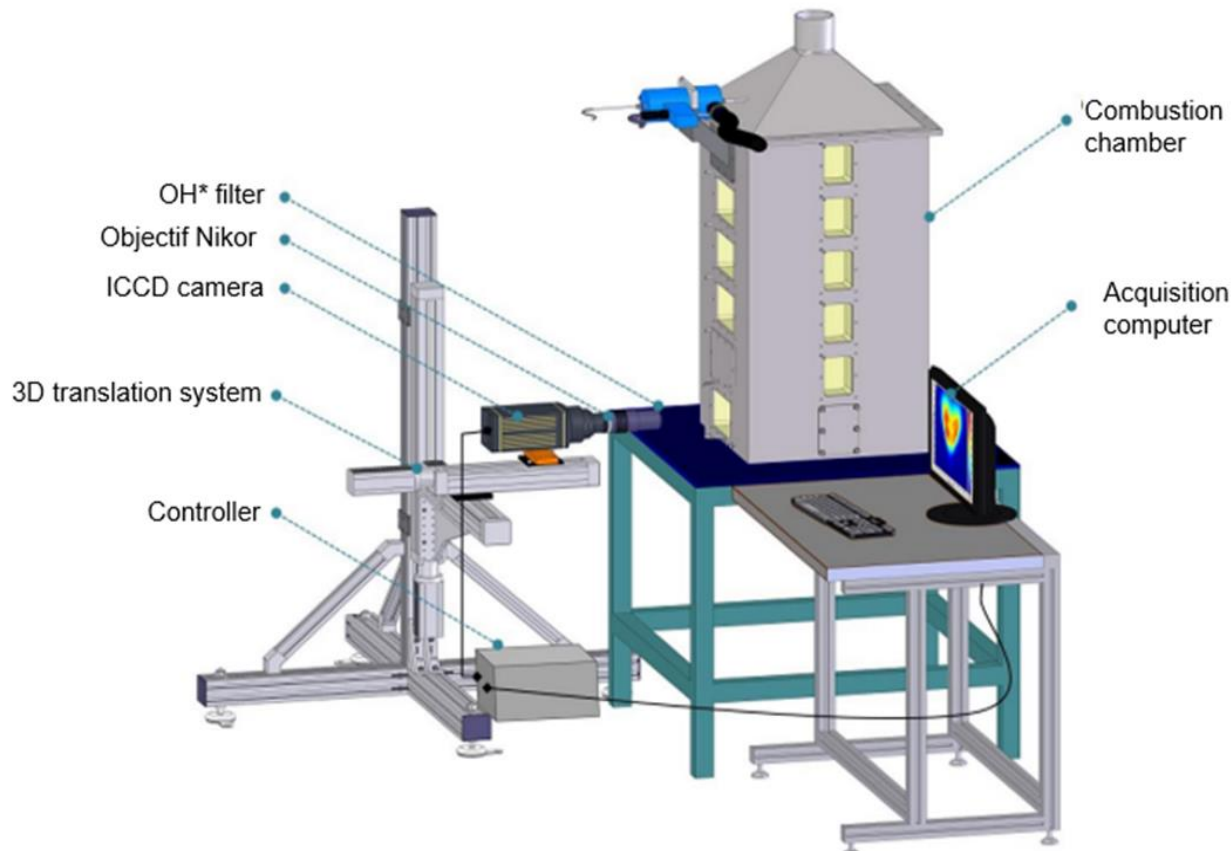

Measurements and analysis of flue gases

- Concentrations of NO_x and CO in flue gases are measured.
- HORIBA PG250 multi-gas analyzer

OH* chemiluminescence technique

- Apparatus : ICCD camera, a 105 mm UV lens, a $325\pm 55\text{nm}$ band-pass filter, and an acquisition card with a computer.
- Visualization of flame front stability, lift-off heights, and flame lengths.

Optical emission spectra

- Ocean FX-XR1, with a wavelength range of 200-1025 nm.

Plasma configuration

- The **Rod-ring** microsecond pulsed plasma is generated between the grounded elongated injector (cathode), and the HV electrode (in ring form) placed around the central rod.

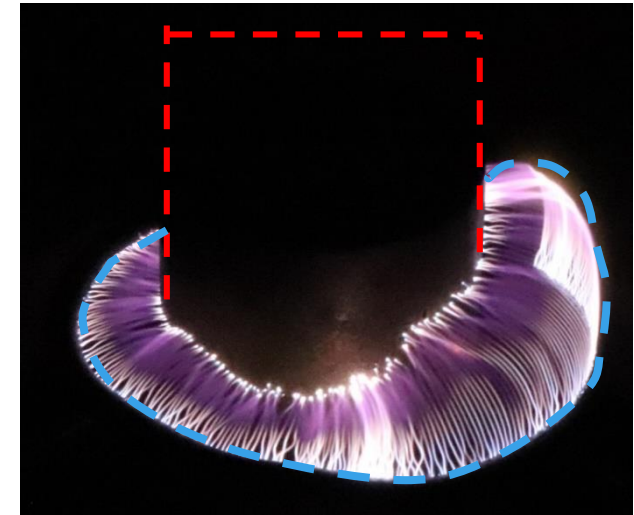
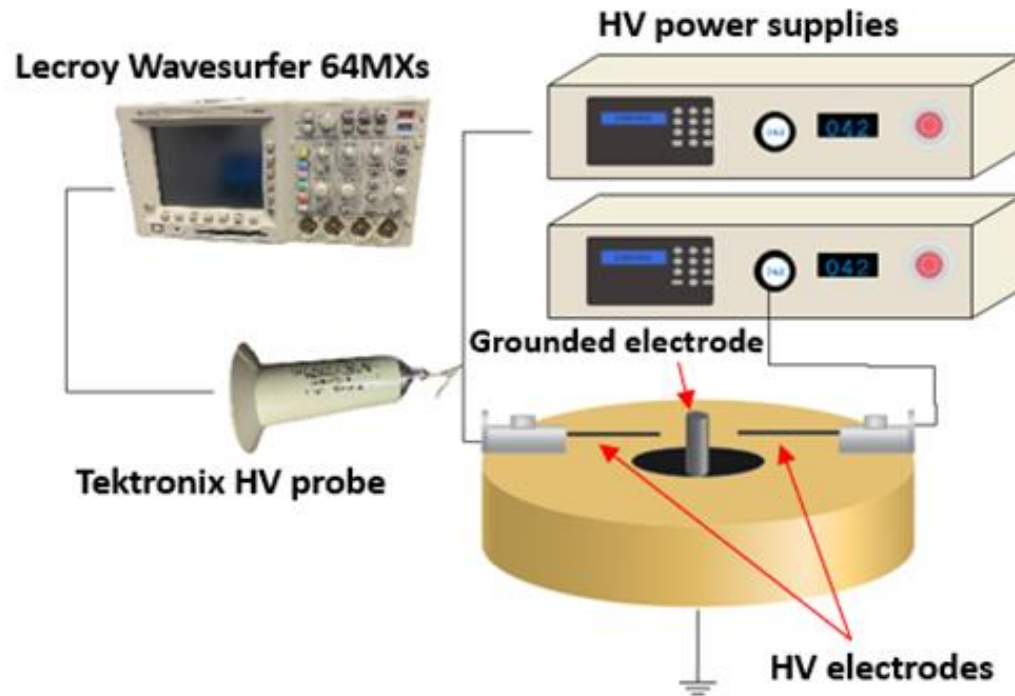

- The plasma expands in the air and glides around the central rod all over the ring

Electrical measurements

Temporal evolution of HV pulse without and with plasma activation

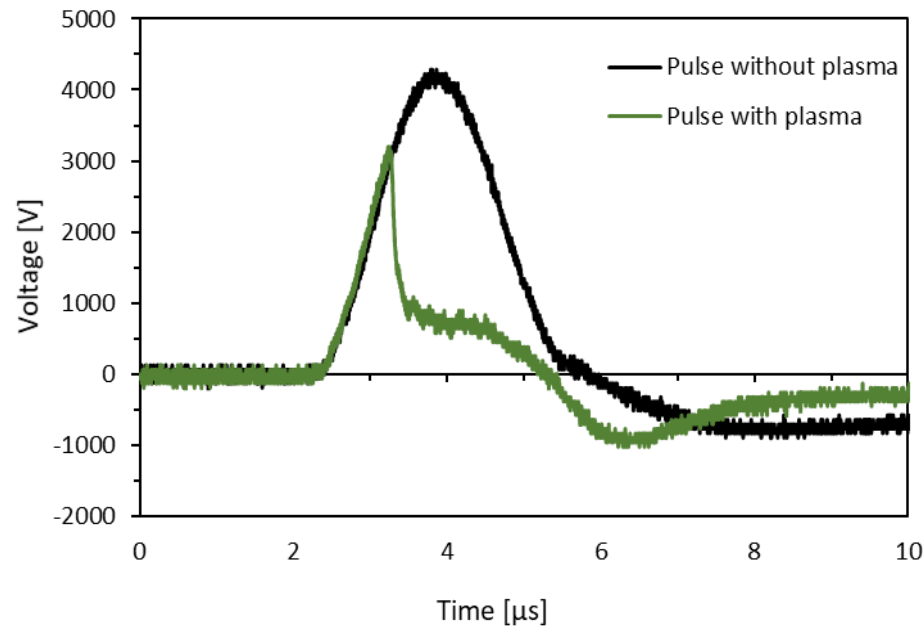

Plasma input power at different plasma frequencies and voltages

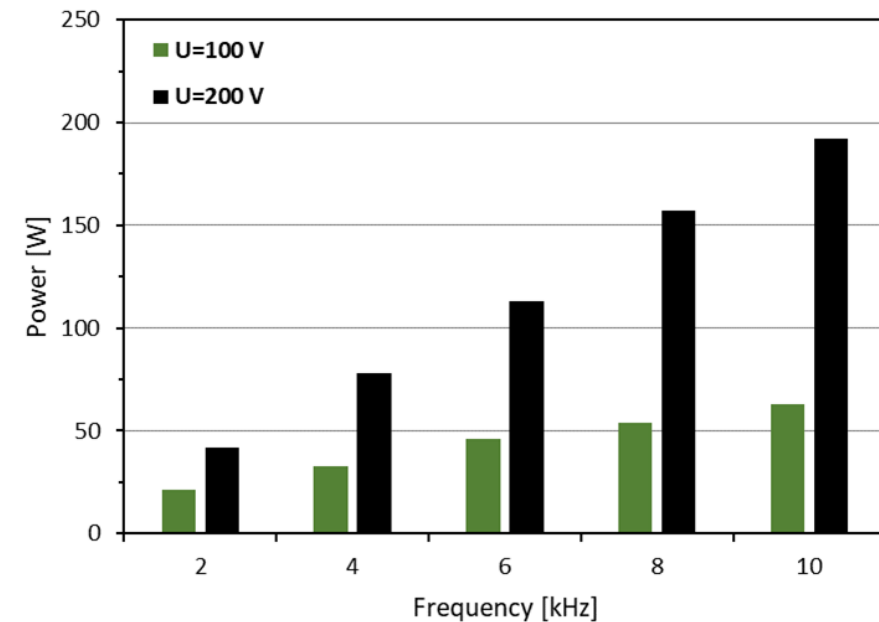

- The applied voltage is measured at $4.2 \text{ kV} \pm 410 \text{ V}$ for the different operating conditions.
- The plasma ignition modifies the form of the voltage pulse.
- The microsecond pulsed plasma consumes a **considerable amount of energy** at different plasma operating conditions.

Flame stability

Operating conditions: % of CO₂ in the fuel mixture, flow rates of CO₂, CH₄ and air, bulk velocity of the fuel (CO₂+CH₄) and air, swirl number and flame power.

Equivalence ratio (Φ)	Air flow rate [NL/min]	CH ₄ flow rate [NL/min]	%CO ₂	CO ₂ flow rate [NL/min]	V fuel [m/s]	Vair [m/s]	Swirl number	Flame power
1	80	8.4	0	0	2,65	1,49	SN0.5	4.75
			30	3.6	3,65			

- Both flames appeared to be longer, closer to the burner, and with more yellow/orange luminosity with plasma activation which might be caused by an increase in the soot region.
- The reduction of the lift-off height with the presence of the plasma and by increasing the frequency.

Direct photographs of CH₄ and CH₄/CO₂ flames without and with plasma at different frequencies.

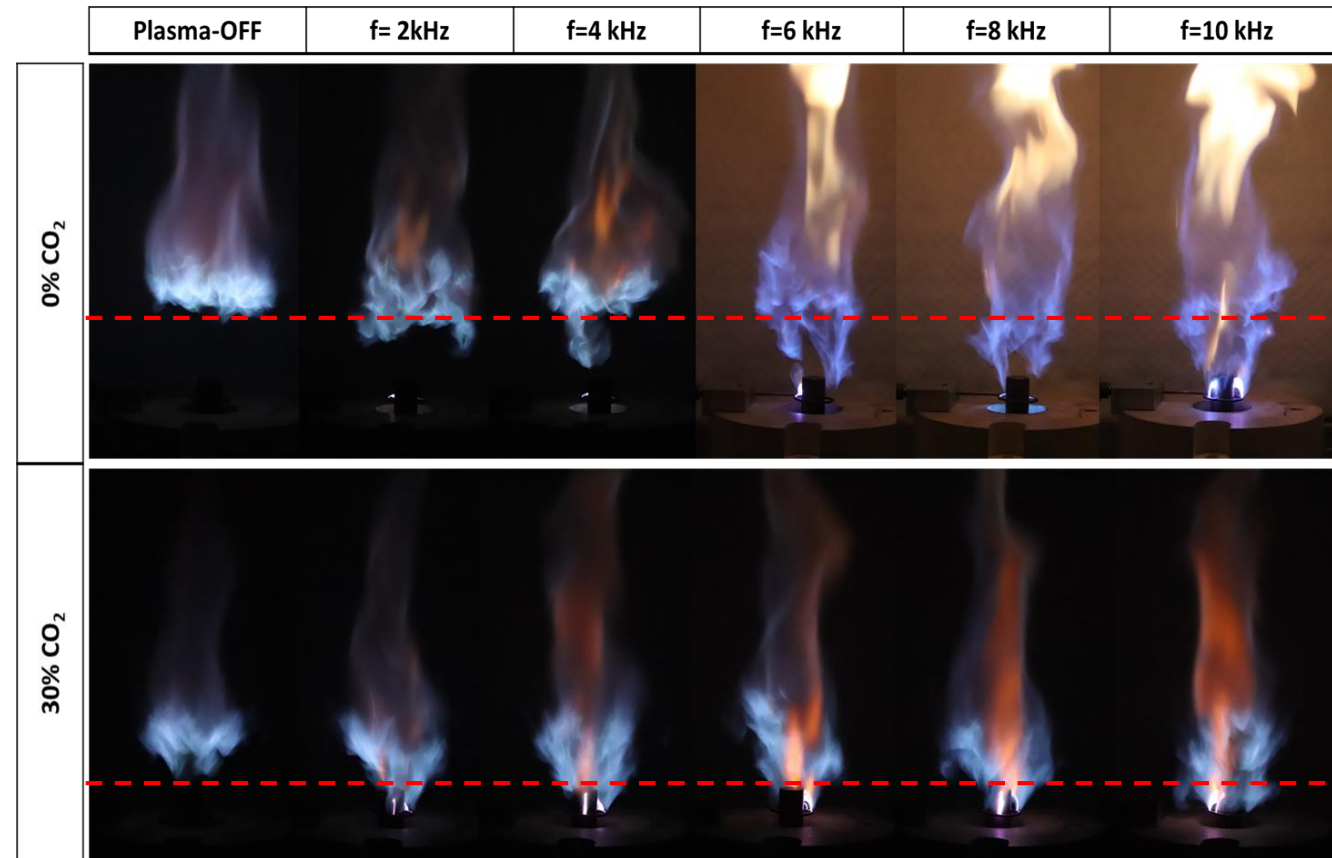

OH* chemiluminescence average images

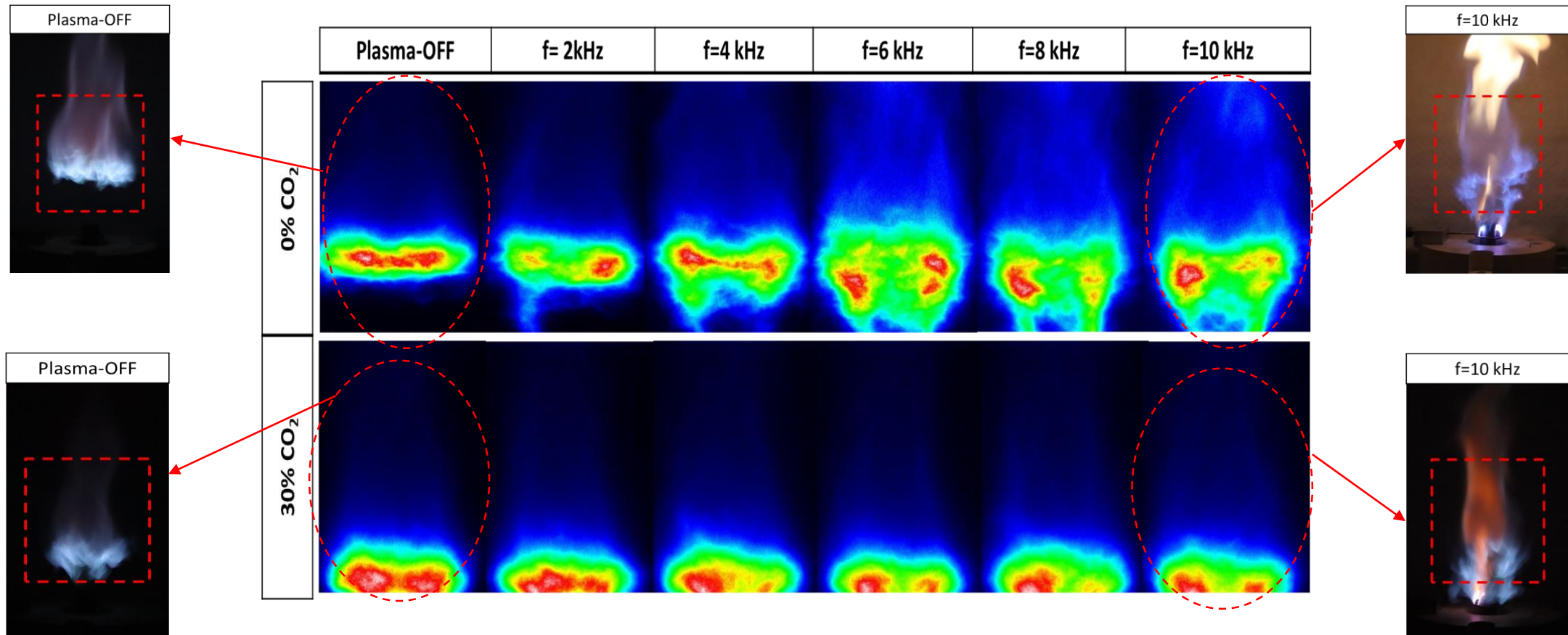

- The addition of CO₂ to the fuel directs the flame toward the holes of the fuel injector.
- The distribution of OH* follows the movement of the plasma along the ring.

Optical emission spectra

Optical emission spectra of CH₄-Air and 70%CH₄/30%CO₂-Air flames with and without plasma activation. The integration time is 2s.

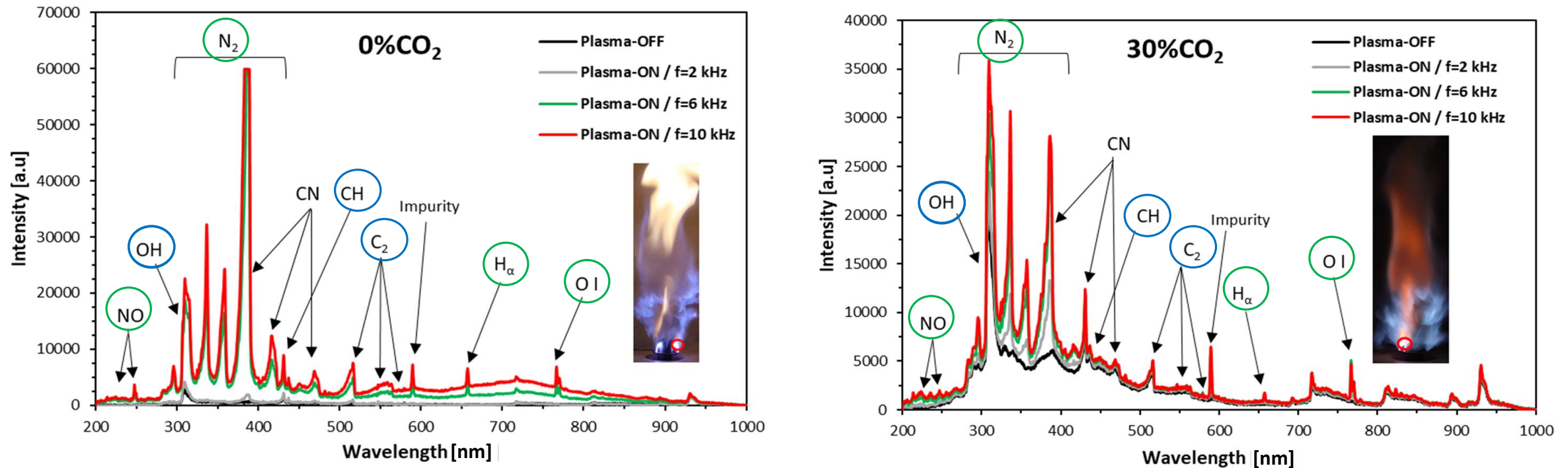

- The excited species OH*, C₂*, CN*, and CH* are amplified with plasma and for a further increase of the frequency.
- The spectral peaks of the excited N₂* and NO* molecules, H_α* and O* atoms appeared with plasma activation, and their intensities level increase with increasing frequency.

Optical emission spectra of the well-known spectral peaks for a hydrocarbon-air flame detected with plasma at two different input voltages, $f=10$ kHz.

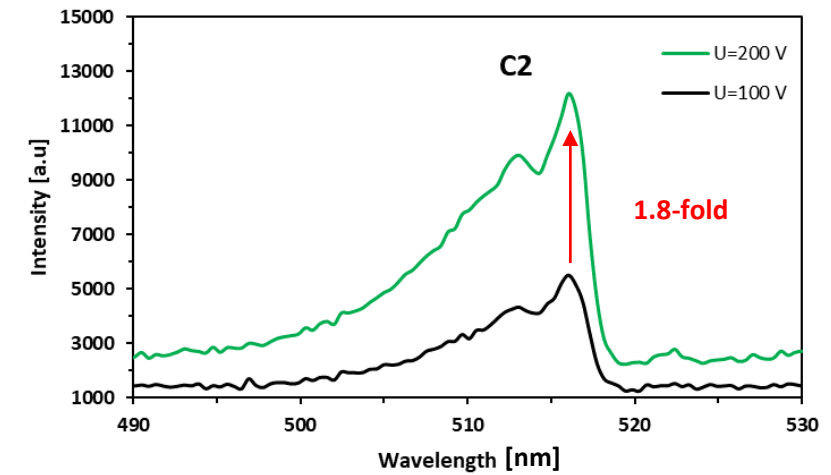
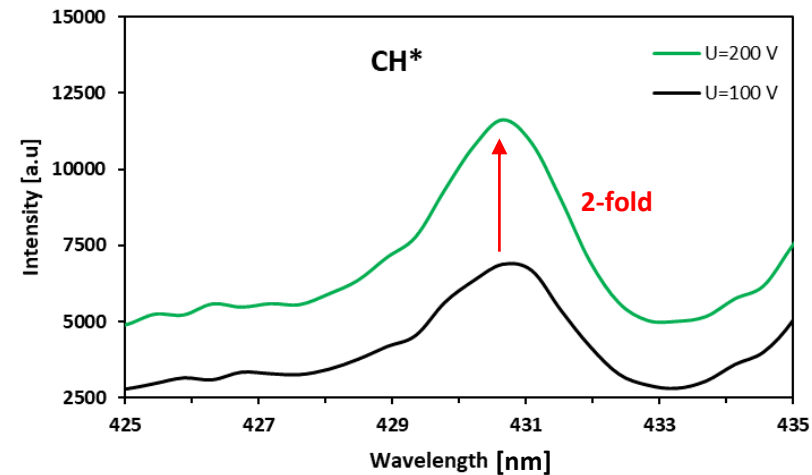
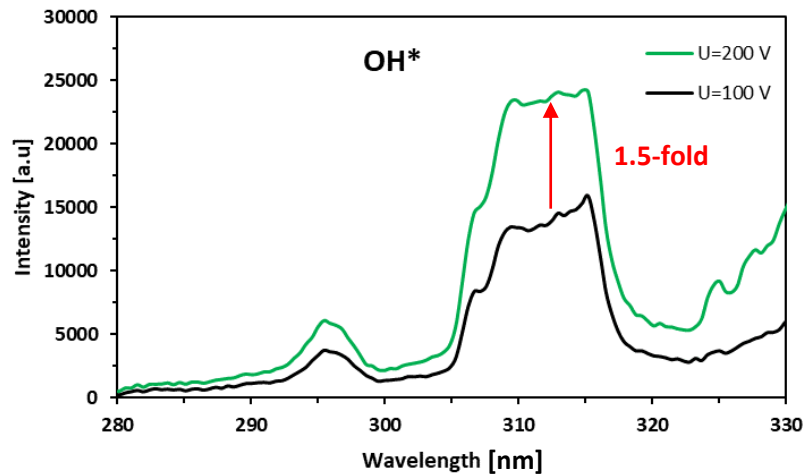

- The line intensity of free radicals such as OH*, CH*, and C₂* increased by increasing the input electrical voltage of 100V (from 100 V to 200 V) at a fixed plasma frequency of 10 kHz.

Optical emission spectra of intermediate chemical species that were detected with plasma activation at two different input voltages, $f=10$ kHz.

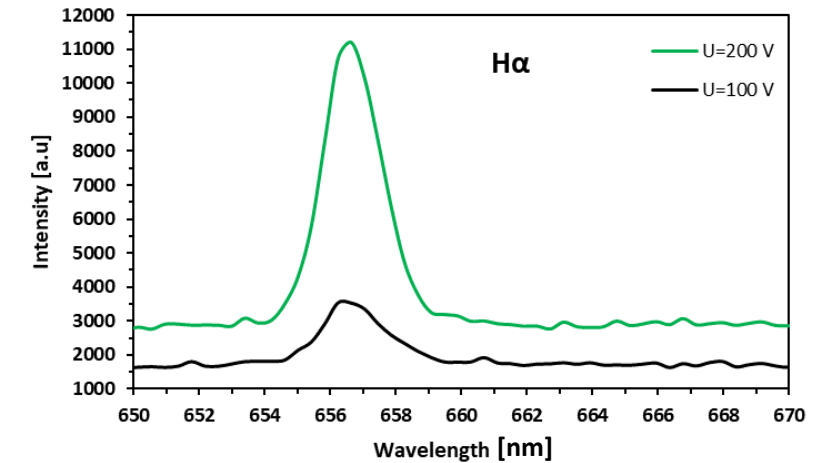
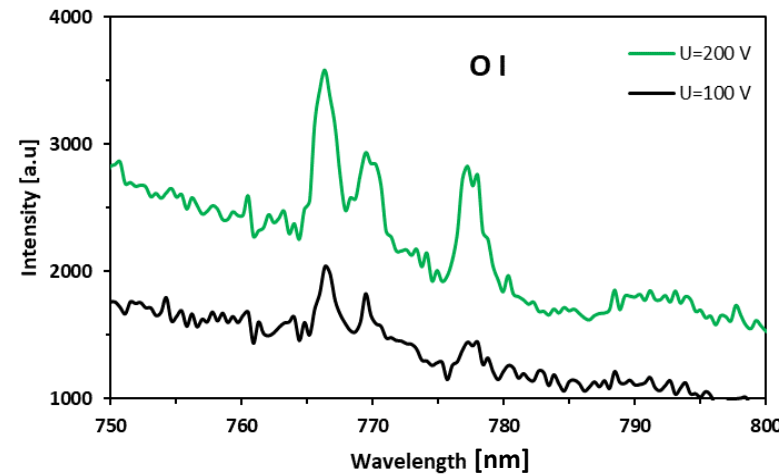
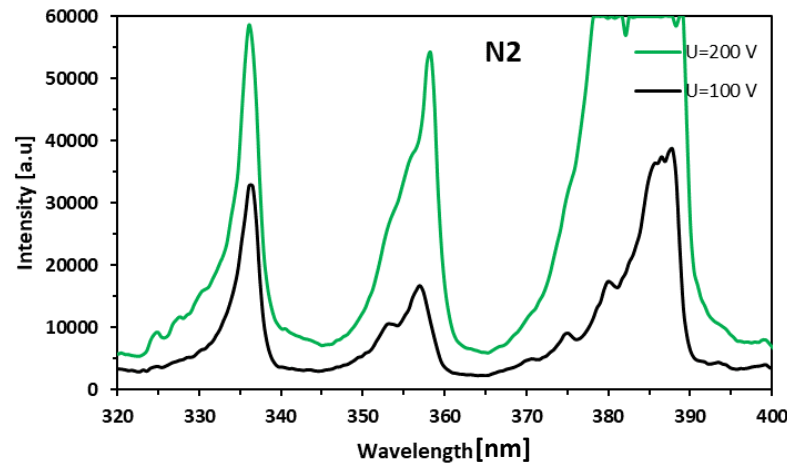

- Plasma generates a lot of intermediate chemical species, such as excited N_2^* , NO^* , O^* , and H^* .
- N_2 dominates the spectra with plasma activation.
- The emitted O (777 nm) is due to the dissociation of O_2 with the excited N_2^* ($N_2^* + O_2 \rightarrow N_2 + O + O$) \longrightarrow O atoms transfer energy to the gas.
- Their intensity levels increase with increasing input voltage.

Pollutant emissions

Effects of rod-ring pulsed plasma on NO_x emissions at different plasma conditions for CH_4 -Air and $70\%\text{CH}_4/30\%\text{CO}_2$ -Air flames

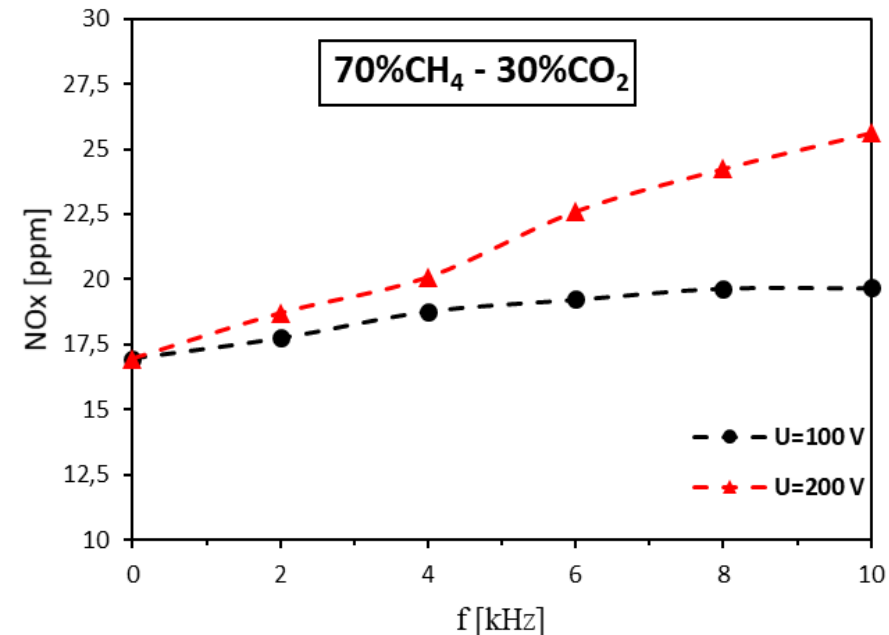
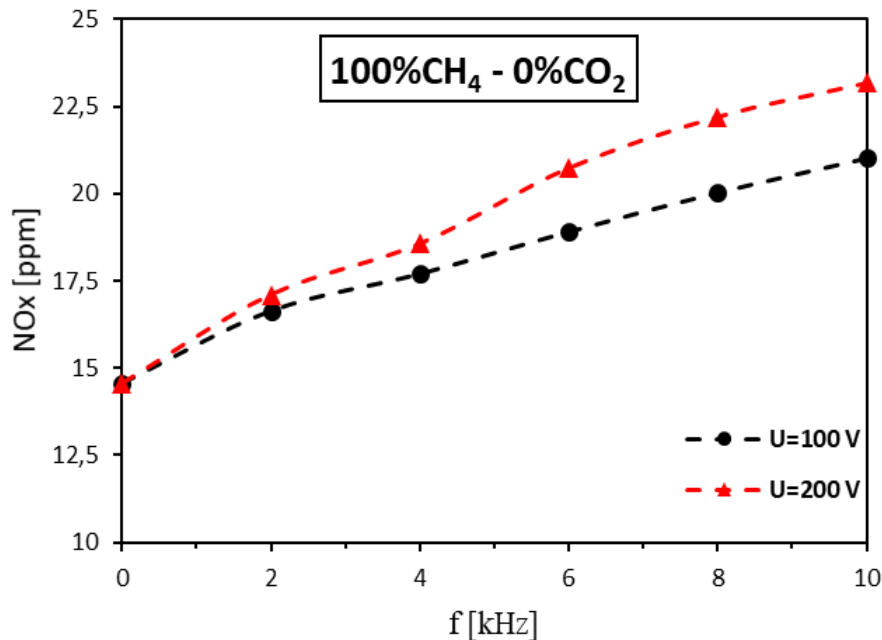

- Slight increase in NO_x emissions with increasing plasma frequency → due to an increase in local temperature and to the generation of meaningful amounts of N^* and O^* radicals by the plasma.
- At high plasma powers, NO^* formation rates from atomic oxygen and various excited states of N_2^* increase leading to increased NO_x emissions.

Effects of rod-ring pulsed plasma on CO emissions at different plasma conditions for CH₄-Air and 70%CH₄/30%CO₂-Air flames

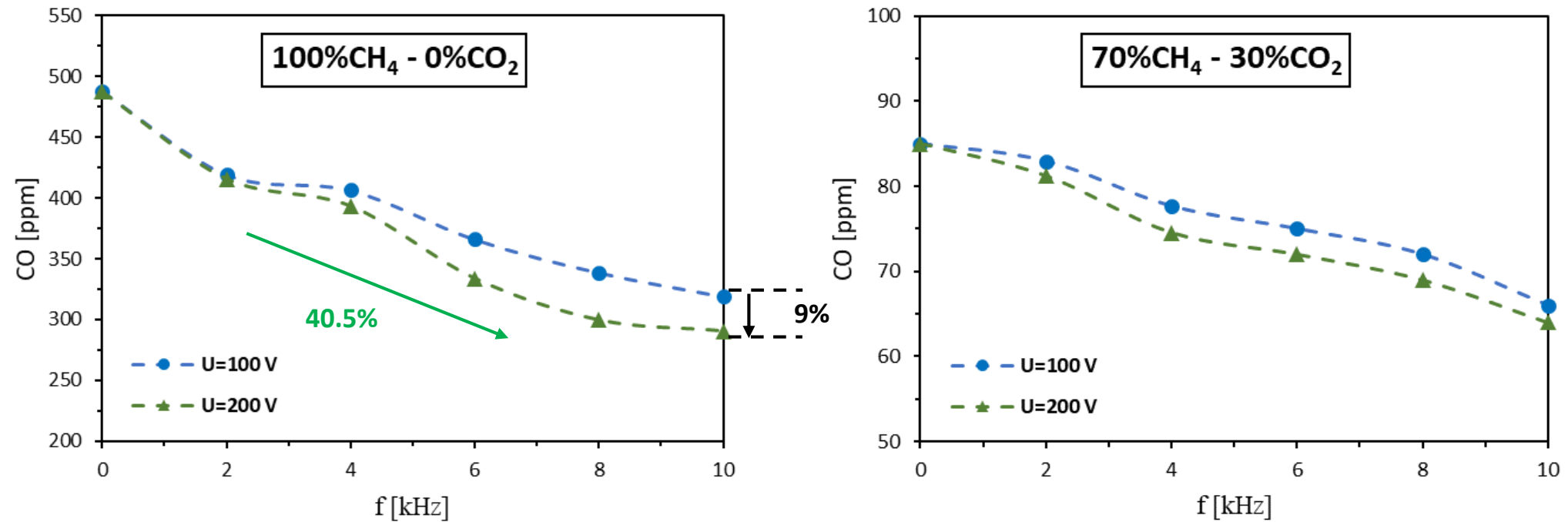

- The presence of the plasma significantly decreases the CO content in flue gases → due to more complete burning of the fuel ($\text{CO} + \text{OH}^* \leftrightarrow \text{CO}_2 + \text{H}^*$).

Conclusion

- Rod-ring microsecond pulsed plasma plays a very important role to stabilize the flame, the lift-off height of the biogas flame decreases significantly with the presence of the plasma and by increasing the plasma input electrical voltage and pulse repetition frequency.
- The rod-ring pulsed plasma can considerably reduce the CO emission of biogas flames. However, NO_x emissions can significantly increase with the plasma addition.
- The Optical emission spectra measurements indicated that the rod-ring pulsed plasma generates a lot of intermediate chemical species, such as excited N₂^{*}, NO^{*}, O^{*}, and H^{*}.
- Microsecond pulsed plasma plays an important role to stabilize the flame, plasma chemistry involved with the excited N₂ molecule, Hα^{*} and O^{*} atoms lead to favorable effects on flame.

Prospects

- Other cases of flame and plasma configurations will be investigated
- Flow velocity with and without plasma (PIV; LDA)
- Temperature measurements in the flame with and without plasma.
- Plasma temperatures (rotational and vibrational)

Thank you for your attention!
Any questions?

Email Address: ahlem.ghabi@cnrs-orleans.fr

Appendix 1: **Microsecond pulsed plasma**

impulse power supply

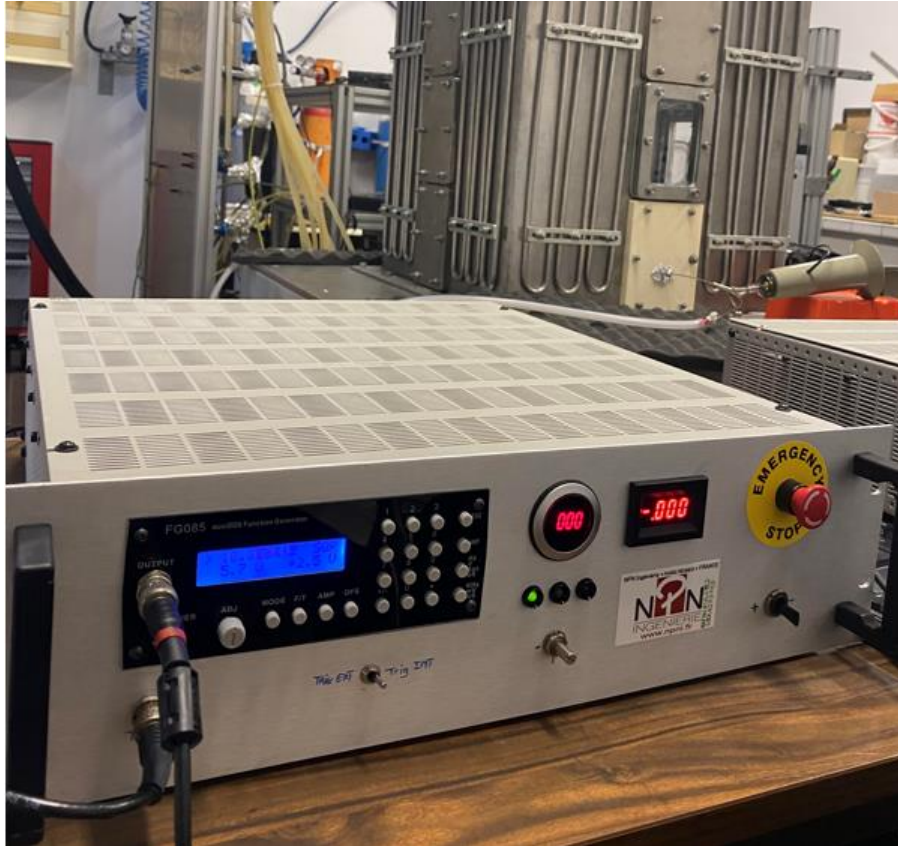

Characteristics:

Pulse duration: 2 μ s

Frequency: from 1 to 30 kHz.

Primary voltage: 0 to 350 VDC

Output voltage: 0 to 30kV

Adjustable parameters: Frequency and voltage

Appendix 2: Swirler

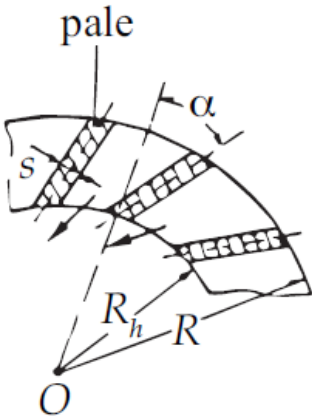
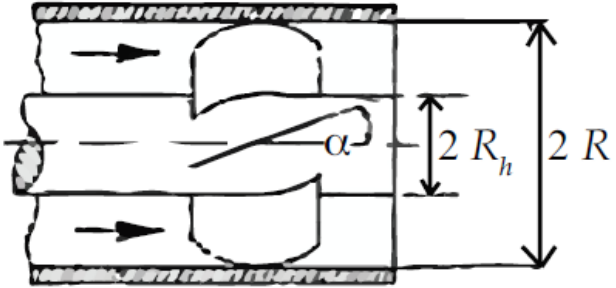

$$S_n = \frac{1}{1 - \psi} \left(\frac{1}{2}\right) \frac{1 - (R_h/R)^4}{1 - (R_h/R)^2} \tan \alpha_0$$

- α_0 : vane angle
- ψ : blockage factor
- R : nozzle radius
- R_h : vane pack hub radius

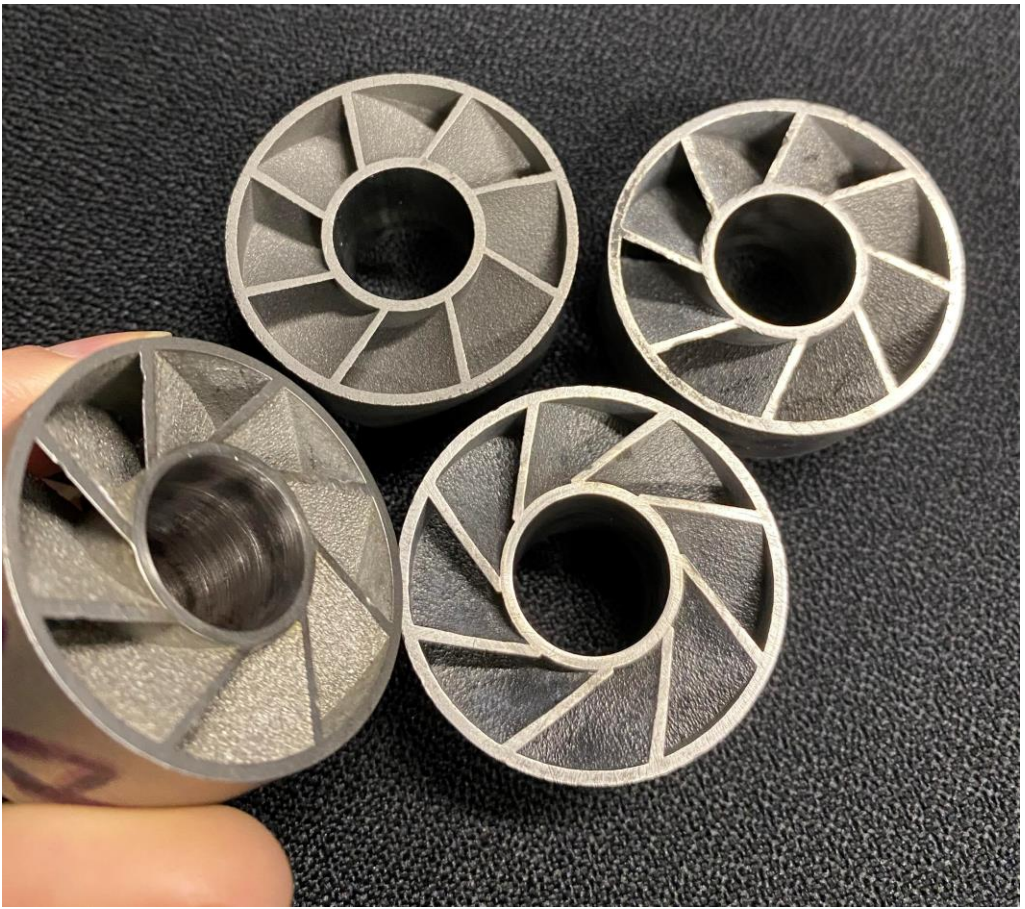

Appendix 3: video of a methane/air flame without and with plasma (f=10 kHz; U=200 V)

