



HAL
open science

Non-contact atomic force microscopy in ultra-high vacuum : concepts & recent trends

Laurent Nony

► **To cite this version:**

Laurent Nony. Non-contact atomic force microscopy in ultra-high vacuum : concepts & recent trends. Doctoral. École d'été "NANOSUM" - Carry le rouet, France. 2022, pp.168. hal-04068413

HAL Id: hal-04068413

<https://cnrs.hal.science/hal-04068413>

Submitted on 13 Apr 2023

HAL is a multi-disciplinary open access archive for the deposit and dissemination of scientific research documents, whether they are published or not. The documents may come from teaching and research institutions in France or abroad, or from public or private research centers.

L'archive ouverte pluridisciplinaire **HAL**, est destinée au dépôt et à la diffusion de documents scientifiques de niveau recherche, publiés ou non, émanant des établissements d'enseignement et de recherche français ou étrangers, des laboratoires publics ou privés.

Public Domain



Institut Matériaux Microélectronique Nanosciences Provence

Non-contact atomic force microscopy in ultra-high vacuum : concepts & recent trends

Laurent Nony
laurent.nony@univ-amu.fr

Aix-Marseille Université
CNRS, Institut Matériaux Microélectronique et Nanosciences de Provence, UMR 7334, 13397, Marseille, France

NANOSUM, June 13th 2022, Carry le Rouet, France



Before starting...

- Documents & references :
 - Many documents (including those slides) and references cited in that lecture are available on the AMUBox server:

<https://amubox.univ-amu.fr/s/Xo5Wiqy7kPc3ddS>

- Slides including the symbols :



refer to **important regular articles, review articles, or books**, some of which are provided in the above link



won't be addressed during that lecture due to lack of time. They remain included in the flow of slides as they are thematically relevant and may be usefull to you when you reread that lecture with a clear head.

Pentacene, chemical structure

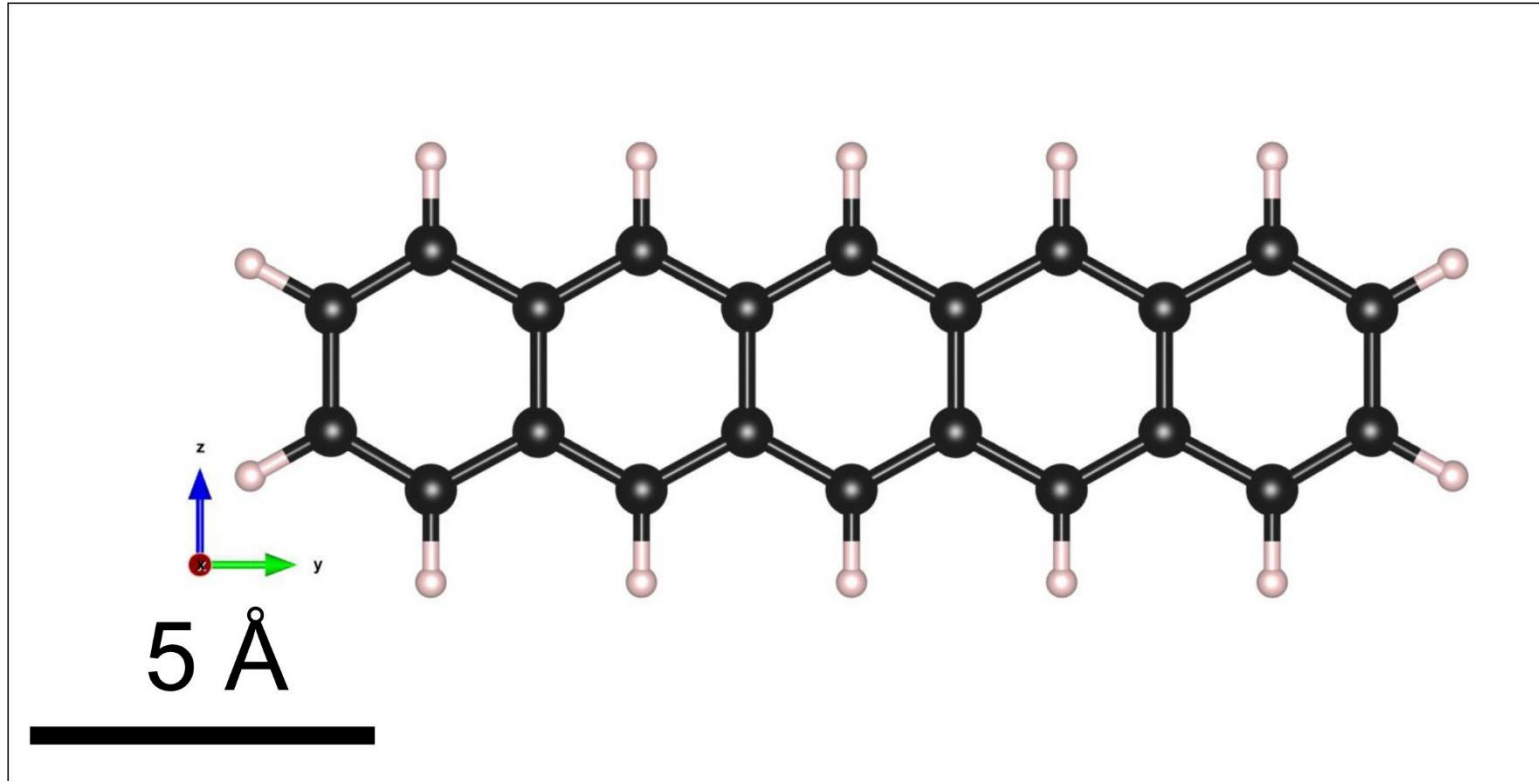

Pentacene: a prototypical organic semi-conductor

Fundamental physics

Charge manipulation

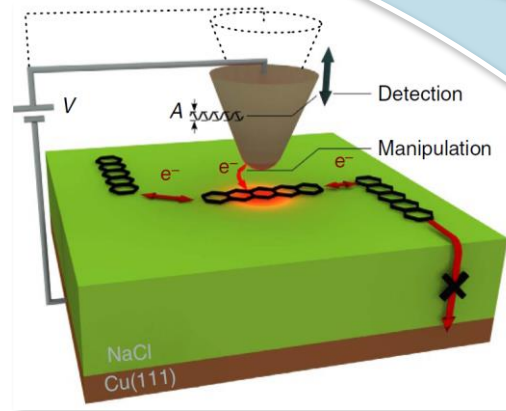

« Probe-based measurement of lateral single-electron transfer between individual molecules »

W. Steurer *et al.*, *Nature Comm.* **6**, 8353 (2015)

Excitonic processes

Exciton Band Structure of Pentacene Molecular Solids: Breakdown of the Frenkel Exciton Model

R. Schuster^{1,2} and M. Knupfer¹

¹IFW Dresden, Postfach 270116, D-01171 Dresden, Germany

²Institut für Physik, Technische Universität Chemnitz, D-09107 Chemnitz, Germany

H. Berger

Institute of Physics of Complex Matter, Ecole Polytechnique Fédérale de Lausanne (EPFL), CH-1015 Lausanne, Switzerland
(Received 28 June 2006; published 16 January 2007)

Employing inelastic electron scattering we demonstrate here the determination of the exciton dispersion in a molecular solid. The failure of the applied tight-binding description provides strong evidence for a necessary reconsideration of the traditional, Frenkel-exciton based, understanding of the lowest-lying electronic transition in organic semiconductors.

R. Shuster *et al.* *PRL* **98**, 037402 (2007)

Applied physics

Organic photovoltaics

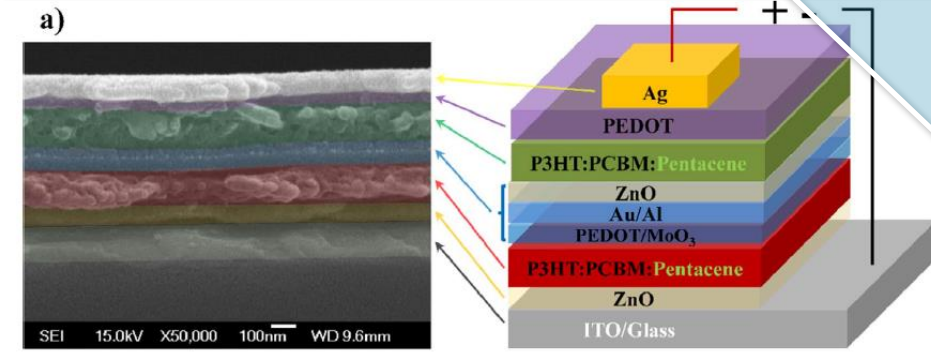

« Pentacene-assisted planarization of photo-active layers for high performance tandem organic photovoltaics »

F. Yang *et al.*, *Solar Energy* **163**, 434–442 (2018)

Organic (field effect) transistors

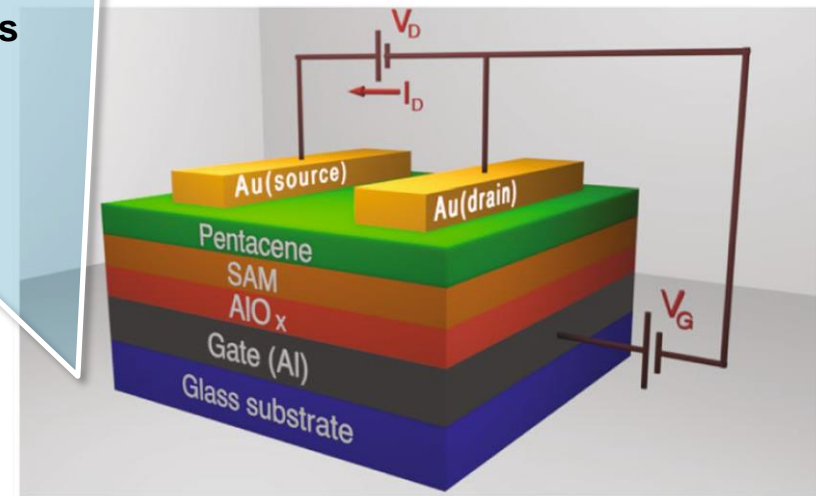

« Orientation analysis of pentacene molecules in organic field effect transistor devices using polarization-dependent Raman Spectroscopy »
B.S. Bhardwaj *et al.*, *Sci. Rep.* **9**, 15149 (2019)

Pentacene, chemical structure

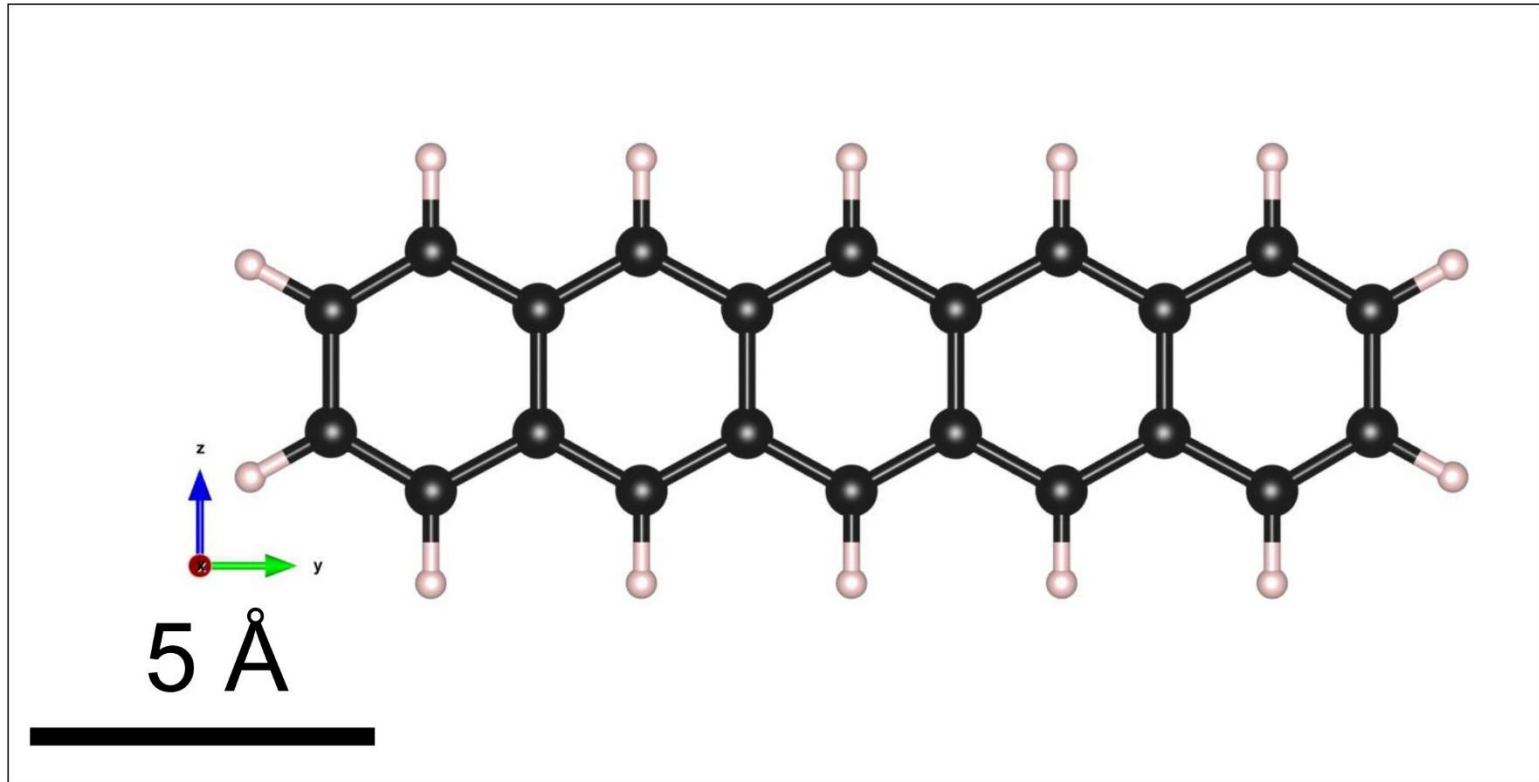

Pentacene, as imaged by Scanning Tunneling Microscopy



« The chemical structure of a molecule resolved by atomic force microscopy »
L. Gross *et al.*, *Science* **325**, 1110 (2009)

Pentacene, as imaged by non-contact Atomic Force Microscopy (nc-AFM)

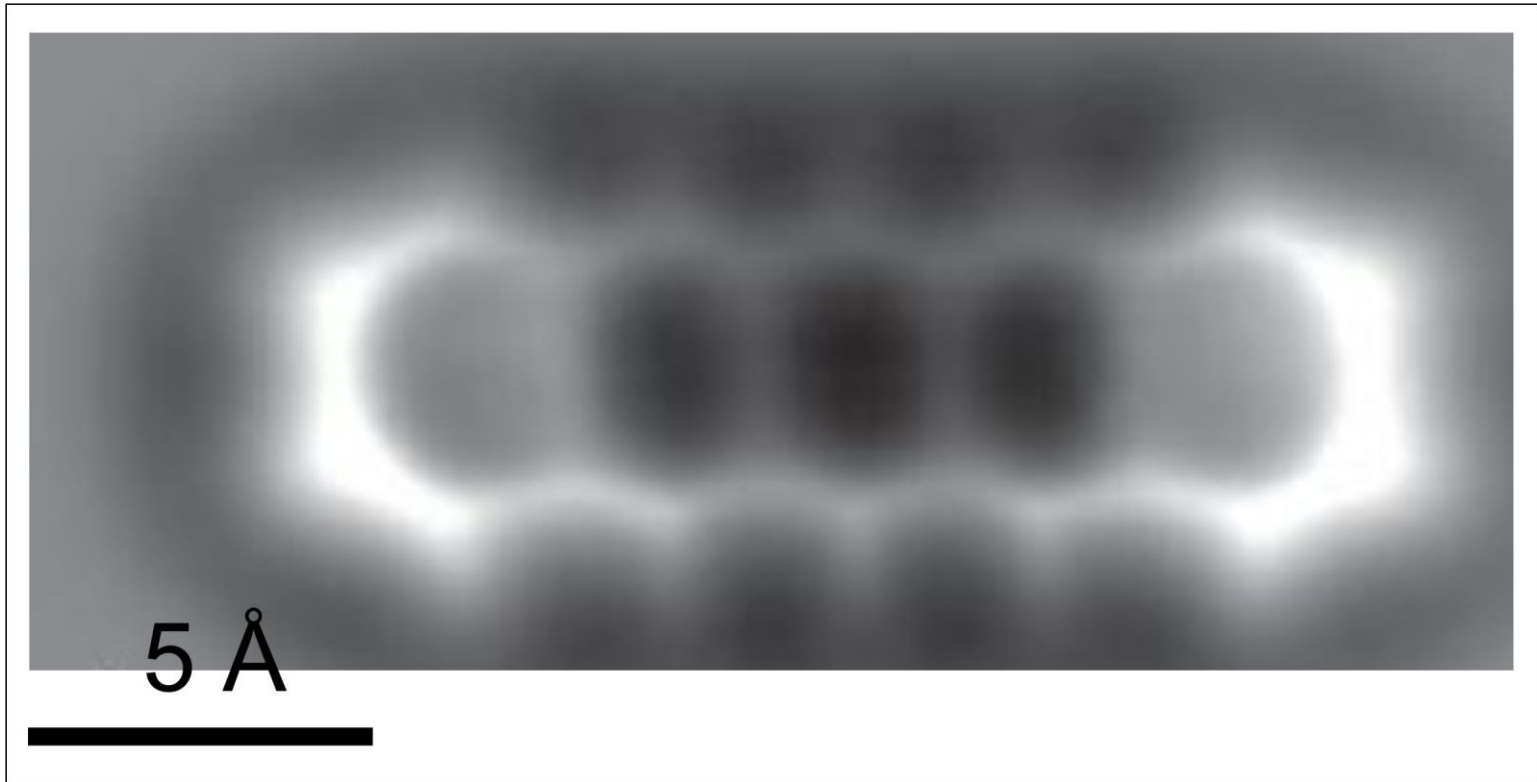

« The chemical structure of a molecule resolved by atomic force microscopy »
L. Gross *et al.*, *Science* **325**, 1110 (2009)

Pentacene, as imaged by non-contact Atomic Force Microscopy (nc-AFM)

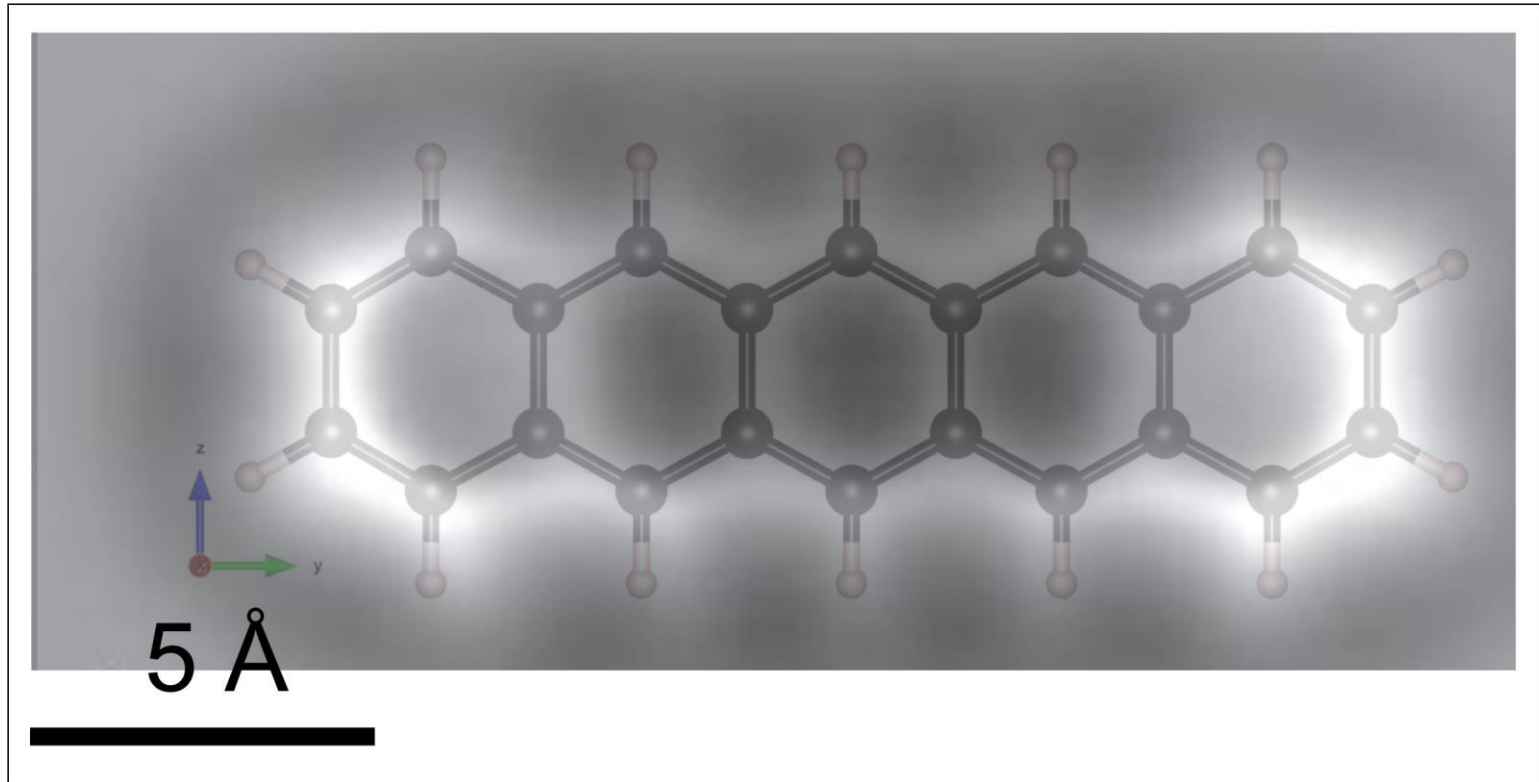

« The chemical structure of a molecule resolved by atomic force microscopy »
L. Gross *et al.*, *Science* **325**, 1110 (2009)



Examples of high-resolution nc-AFM imaging of molecules since 2009



L. Gross *et al.* *Nature Chem.* **2**, 821–825 (2010).

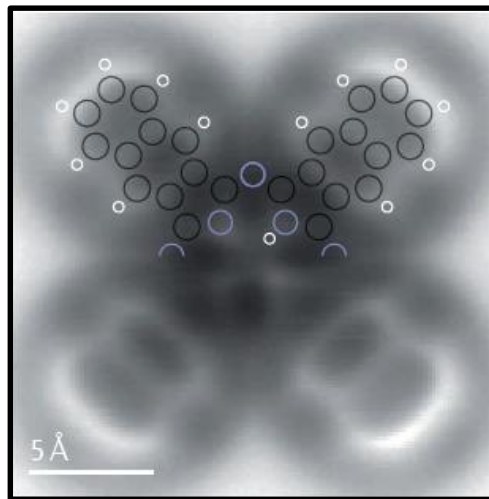

F. Mohn *et al.* *Nat. Nanotechnol.* **7**, 227–231 (2012).

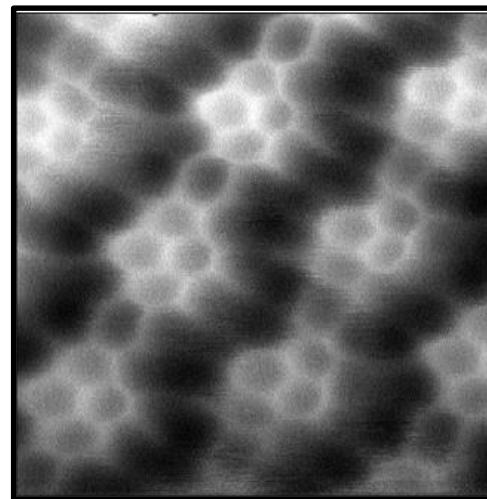

A.M. Sweetman *et al.* *Nature Comm.* **5**, 3931 (2014)

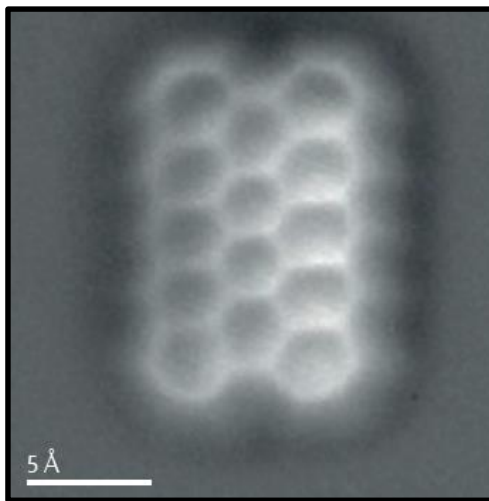

C. Rogers *et al.* *Angew. Chem. Int. Ed.* **54**, 15143–15146 (2015).

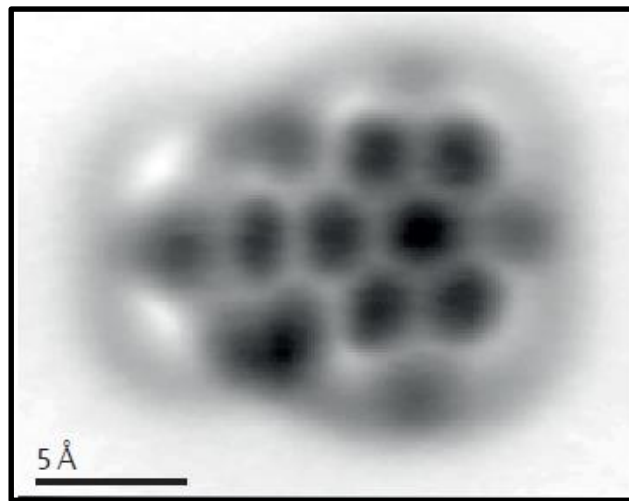

N. Pavlicek *et al.* *Nat. Chem.* **7**, 623–628 (2015).

Examples of high-resolution nc-AFM imaging of molecules since 2009



L. Gross *et al.* *Nature Chem.* **2**, 821–825 (2010).

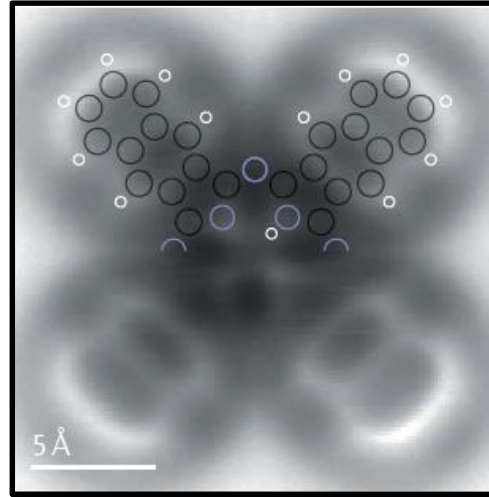

F. Mohn *et al.* *Nat. Nanotechnol.* **7**, 227–231 (2012).

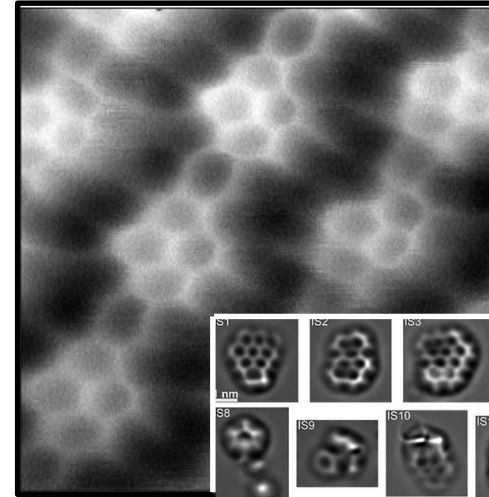

A.M. Sweetman *et al.* (2014)

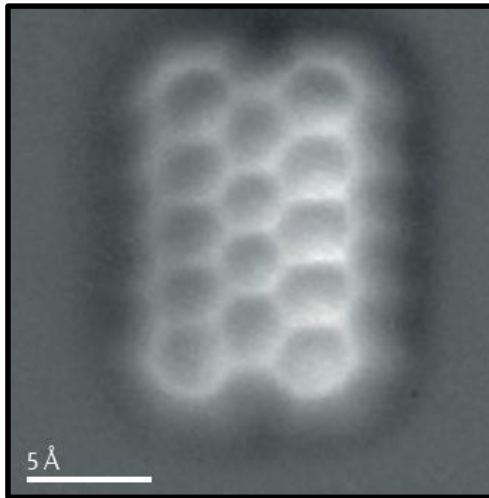

C. Rogers *et al.* *Angew. Chem. Int. Ed.* **54**, 15143–15146 (2015).

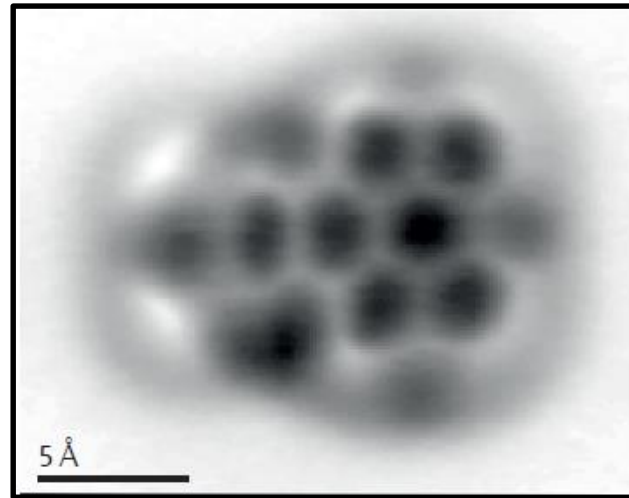

N. Pavlicek *et al.* *Nat. Chem.* **7**, 623–628 (2015).

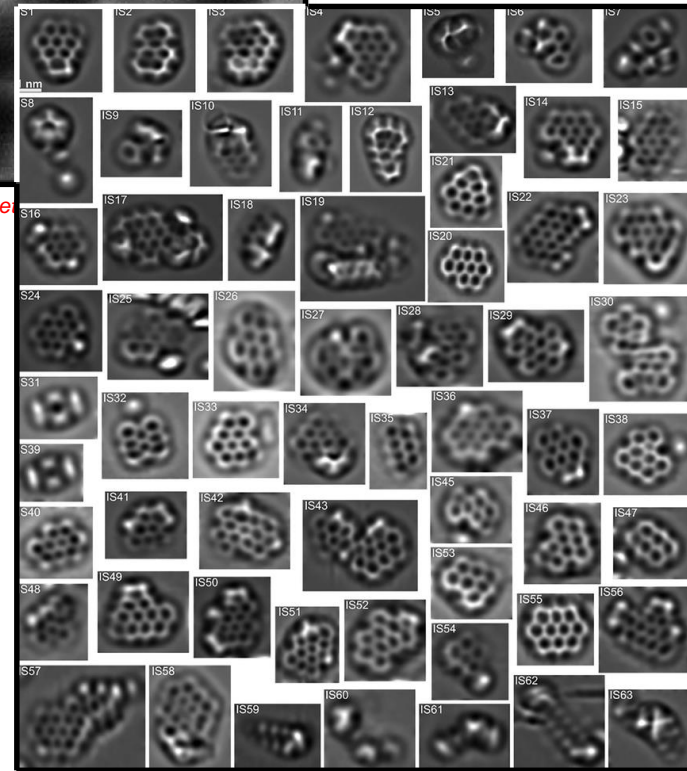

M. Commodo *et al.* *Combustion and Flame* **205**, 154–164 (2019)



Reference / review papers & books

- “Resolving Intra- and Inter-Molecular Structure with Non-Contact Atomic Force Microscopy”

S. Jarvis, Int. J. Mol. Sci. **16**, 19936-19959 (2015)

- “Generation, manipulation and characterization of molecules by atomic force microscopy”

N. Pavlicek & L. Gross, Nature Reviews Chemistry **1** (2017)

High-resolution nc-AFM imaging: molecules, but bare surfaces too (earlier results)...

CaF₂

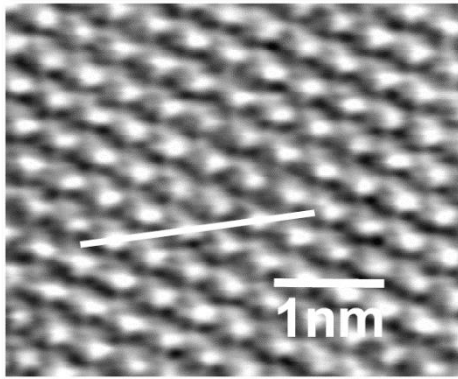

C. Barth *et al.*
J. Phys.: Condens. Matter **13**, 2061(2001)

**NaCl islands on
Cu(111)**

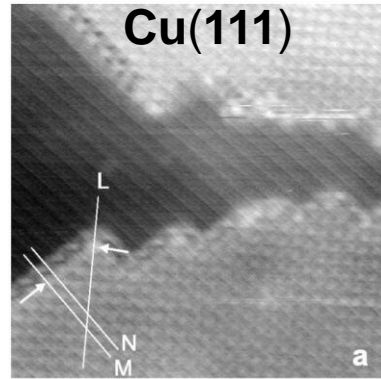

R. Bennewitz *et al.*
Phys. Rev. B **13**, 2061 (2001)

KBr + e⁻

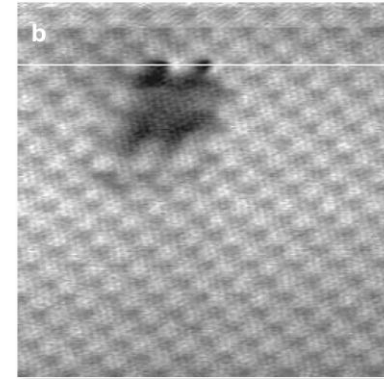

R. Bennewitz *et al.*
Surf. Sci. **474**, L197 (2001)

NiO(001) @7K

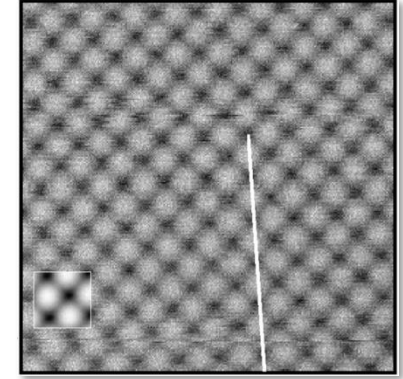

R. Hoffmann *et al.*
Phys. Rev. B **67**, 085402 (2003)

Insulators (ionic crystals, metal oxides)

High-resolution nc-AFM imaging: molecules, but bare surfaces too (earlier results)...

CaF₂

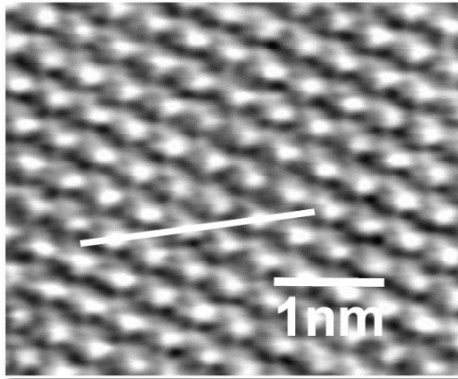

C. Barth *et al.*
J. Phys.: Condens. Matter **13**, 2061(2001)

**NaCl islands on
Cu(111)**

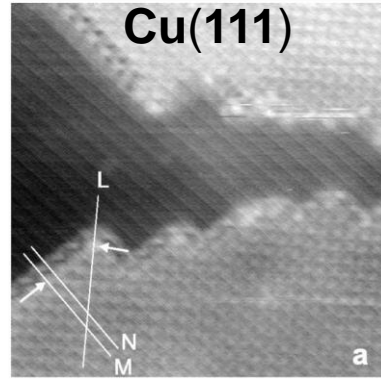

R. Bennewitz *et al.*
Phys. Rev. B **13**, 2061 (2001)

KBr + e⁻

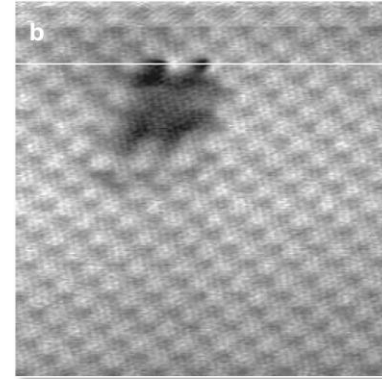

R. Bennewitz *et al.*
Surf. Sci. **474**, L197 (2001)

NiO(001) @7K

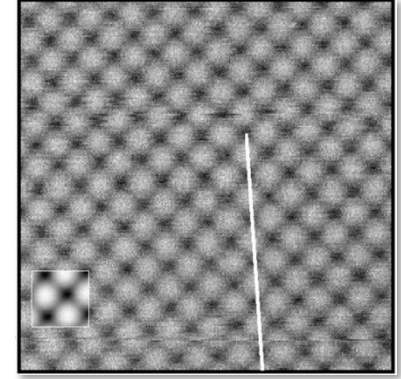

R. Hoffmann *et al.*
Phys. Rev. B **67**, 085402 (2003)

Cu(001)

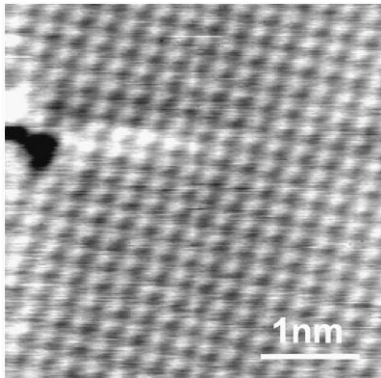

C. Loppacher *et al.*
Phys. Rev. B **62**, 16944 (2000)

Metals

High-resolution nc-AFM imaging: molecules, but bare surfaces too (earlier results)...

CaF₂

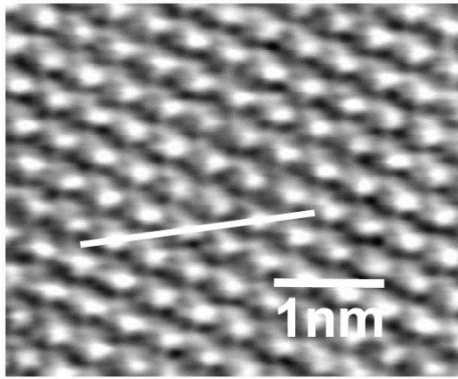

C. Barth *et al.*
J. Phys.: Condens. Matter **13**, 2061(2001)

**NaCl islands on
Cu(111)**

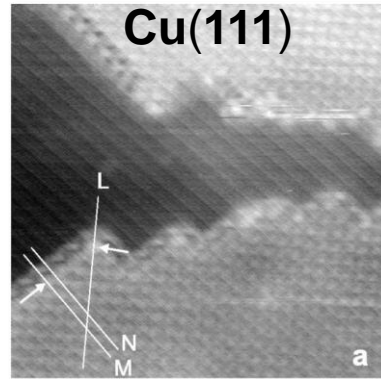

R. Bennewitz *et al.*
Phys. Rev. B **13**, 2061 (2001)

KBr + e⁻

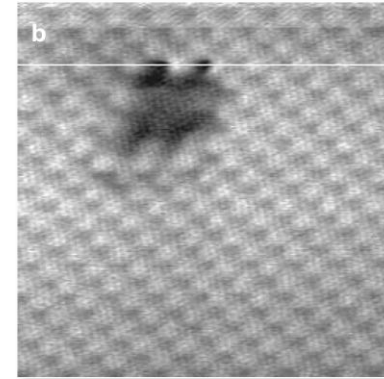

R. Bennewitz *et al.*
Surf. Sci. **474**, L197 (2001)

NiO(001) @7K

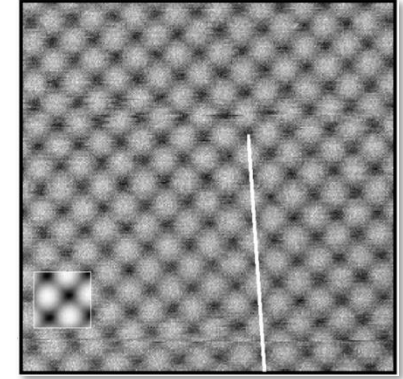

R. Hoffmann *et al.*
Phys. Rev. B **67**, 085402 (2003)

Cu(001)

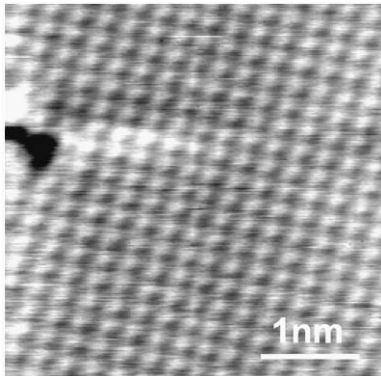

C. Loppacher *et al.*
Phys. Rev. B **62**, 16944 (2000)

InAs(110) @14K

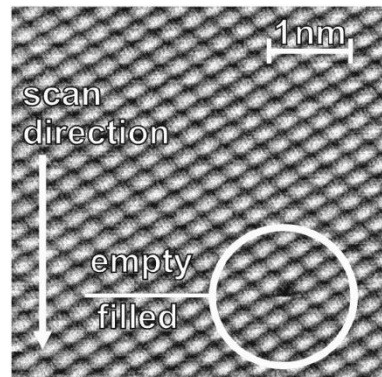

A. Schwarz *et al.*
Phys. Rev. B **61**, 2837 (2000)

Si(111)7x7 @RT & 7K

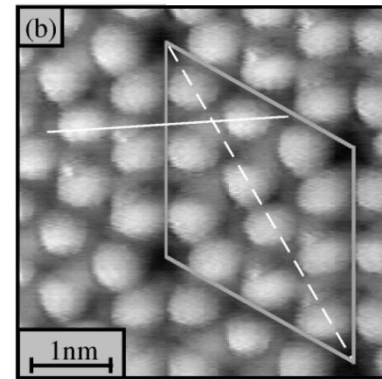

M. Lantz *et al.*
Phys. Rev. Lett. **84**, 2642 (2000)

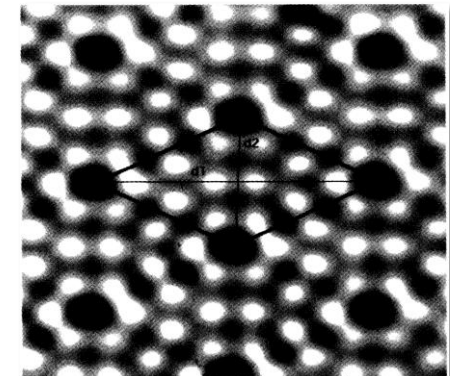

F. Giessibl
Science **267**, 68 (1995)

Semi-conductors

Beyond « imaging »...

- Promoting / tracking chemical synthesis at the atomic scale :

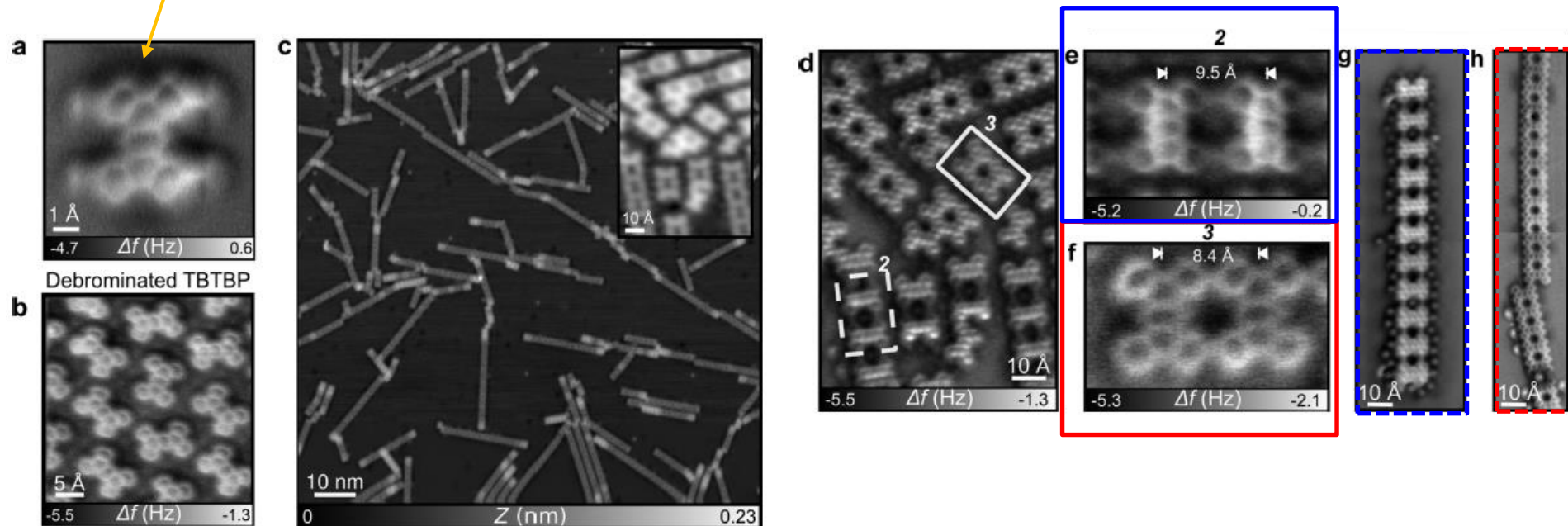
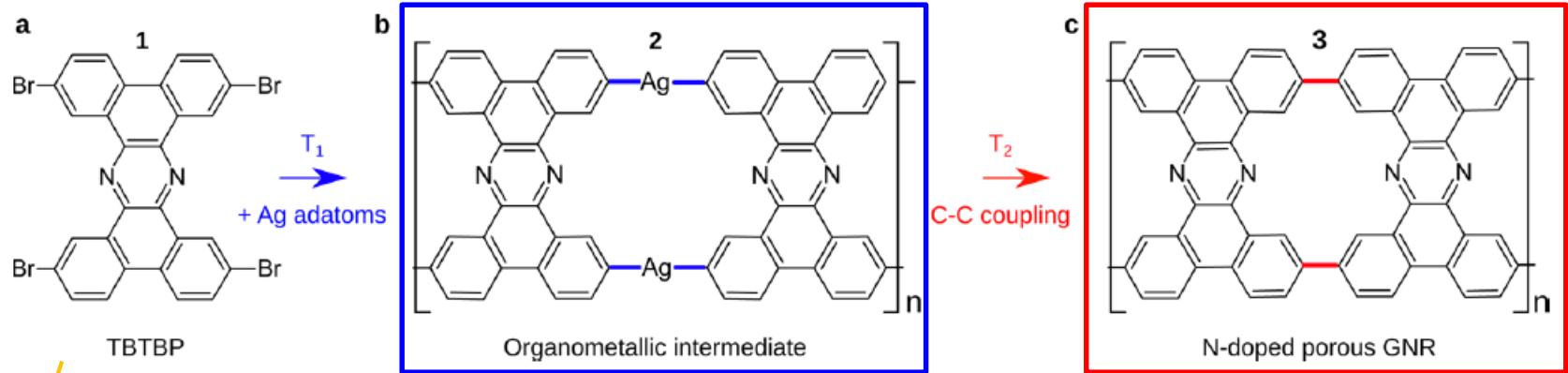

Beyond « imaging »...

- Chemical identification at the atomic scale :



Y. Sugimoto *et al.* Nature **446**, 64 (2007)



VOLUME 92, NUMBER 14

PHYSICAL REVIEW LETTERS

week ending
9 APRIL 2004

Sublattice Identification in Scanning Force Microscopy on Alkali Halide Surfaces

R. Hoffmann,^{1,2,*} L. N. Kantorovich,³ A. Baratoff,¹ H. J. Hug,^{1,4} and H.-J. Güntherodt¹

¹National Center of Competence in Research on Nanoscale Science, Institute of Physics, University of Basel, Klingelbergstrasse 82, CH-4056 Basel, Switzerland

²Physikalisches Institut, Universität Karlsruhe, 76128 Karlsruhe, Germany

³Department of Physics, School of Physical Sciences and Engineering, King's College London, London WC2R 2LS, United Kingdom

⁴Swiss Federal Laboratory for Materials Testing and Research, CH-8600 Dübendorf, Switzerland

(Received 17 March 2003; published 9 April 2004)

Beyond « imaging »...

- Atomic / molecular manipulation :

PRL 98, 106104 (2007) PHYSICAL REVIEW LETTERS week ending
9 MARCH 2007

Mechanism for Room-Temperature Single-Atom Lateral Manipulations on Semiconductors using Dynamic Force Microscopy

Yoshiaki Sugimoto,¹ Pavel Jelinek,² Pablo Pou,³ Masayuki Abe,^{1,4} Seizo Morita,¹ Ruben Perez,³ and Oscar Custance¹

VOLUME 90, NUMBER 6 PHYSICAL REVIEW LETTERS week ending
14 FEBRUARY 2003

Direct Determination of the Energy Required to Operate a Single Molecule Switch

Ch. Loppacher,^{1,*} M. Guggisberg,¹ O. Pfeiffer,¹ E. Meyer,¹ M. Bammerlin,² R. Lüthi,² R. Schlittler,²
J. K. Gimzewski,^{2,†} H. Tang,³ and C. Joachim³

¹*Institute of Physics, University of Basel, Klingelbergstrasse 82, CH-4056 Basel, Switzerland*

²*IBM Research Division, Zurich Research Laboratory, CH-8803 Rüschlikon, Switzerland*

³*CEMES/CNRS, 29, rue Jeanne Marvig, 31055-Toulouse Cedex, France*

(Received 11 October 2002; published 14 February 2003)

Beyond « imaging »...

- Atomic / molecular charge control :

« Measuring the charge state of an adatom with non-contact atomic force microscopy »
L. Gross et al., Science 324, 1428 (2009)

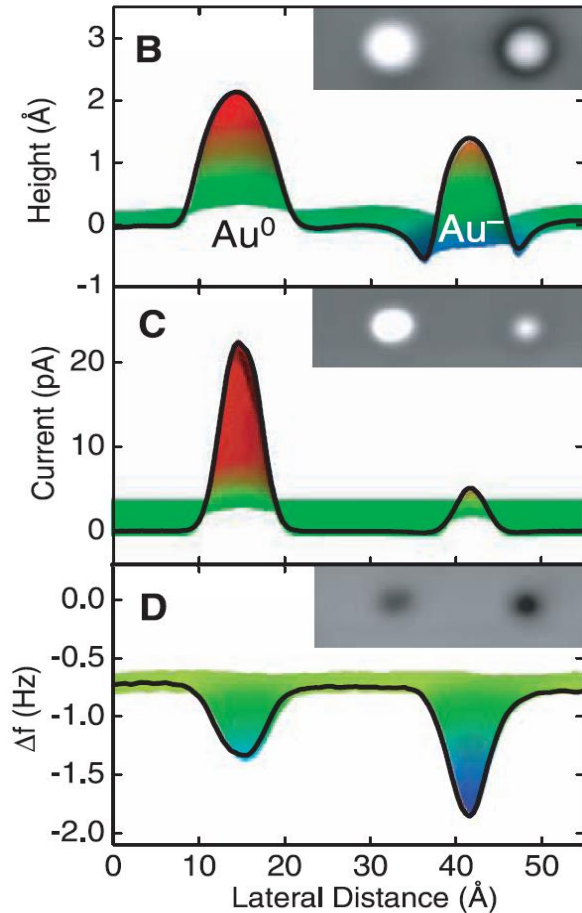

« Probe-based measurement of lateral single-electron transfer between individual molecules »
W. Steurer et al., Nature Comm. 6, 8353 (2015)

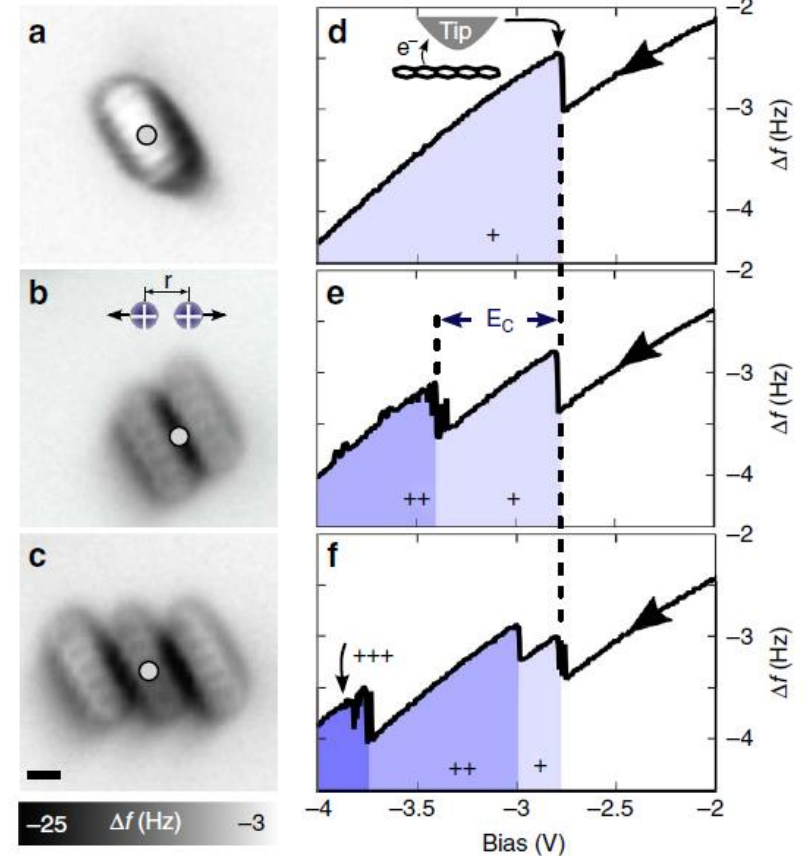
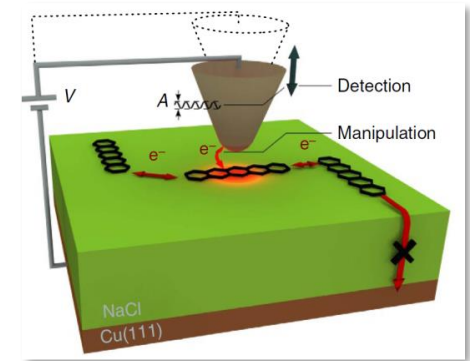

Focus of that lecture

- Introduction to non-contact Atomic Force Microscopy (nc-AFM) :
 - Physical concepts
 - Technical concepts (instrumentation, ultra-high vacuum environment)
 - Examples of recent results
 - Worldwide nc-AFM groups leaders



- How does nc-AFM allow such a spatial resolution?

Outline

A. Scanning Probe Microscopies: historical context

B. Ultra-High Vacuum environment

C. AFM in 4 steps (contact mode concept)

D. Dynamic AFM

E. Non-contact AFM

Outline

A. Scanning Probe Microscopies: historical context

B. Ultra-High Vacuum environment

C. AFM in 4 steps (contact mode concept)

D. Dynamic AFM

E. Non-contact AFM

A – Scanning Probe Micr. : historical context

- Atomic Force Microscopy (AFM) :
 - Developed in 1986 by the contrivers of the **Scanning Tunneling Microscope (STM)**, 1982 at IBM Zurich research lab., G. Binnig & H. Rohrer, Physics Nobel Price)
 - Images of the surface of **any kind of sample** in **real space** with **atomic vertical and lateral resolution** by sensing **interatomic interaction forces** between a nano-tip and the sample surface

STM

Tunneling through a controllable vacuum gap

G. Binnig, H. Rohrer, Ch. Gerber, and E. Weibel
IBM Zurich Research Laboratory, 8803 Rüschlikon-ZH, Switzerland

(Received 30 September 1981; accepted for publication 4 November 1981)

We report on the first successful tunneling experiment with an externally and reproducibly adjustable vacuum gap. The observation of vacuum tunneling is established by the exponential dependence of the tunneling resistance on the width of the gap. The experimental setup allows for simultaneous investigation and treatment of the tunnel electrode surfaces.

PACS numbers: 73.40.Gk

Applied Physics Letters **40**, 178 (1982)

Surface Studies by Scanning Tunneling Microscopy

G. Binnig, H. Rohrer, Ch. Gerber, and E. Weibel
IBM Zurich Research Laboratory, 8803 Rüschlikon-ZH, Switzerland

(Received 30 April 1982)

Error!

Surface microscopy using vacuum tunneling is demonstrated for the first time. Topographic pictures of surfaces on an *atomic scale* have been obtained. Examples of resolved monoatomic steps and surface reconstructions are shown for (110) surfaces of CaIrSn_4 and Au.

PACS numbers: 68.20.+t, 73.40.Gk

Physical Review Letters **49**, 57 (1982)

AFM

Atomic Force Microscope

G. Binnig^(a) and C. F. Quate^(b)

Edward L. Ginzton Laboratory, Stanford University, Stanford, California 94305

and

Ch. Gerber^(c)

IBM San Jose Research Laboratory, San Jose, California 95193

(Received 5 December 1985)

The scanning tunneling microscope is proposed as a method to measure forces as small as 10^{-18} N. As one application for this concept, we introduce a new type of microscope capable of investigating surfaces of insulators on an atomic scale. The atomic force microscope is a combination of the principles of the scanning tunneling microscope and the stylus profilometer. It incorporates a probe that does not damage the surface. Our preliminary results *in air* demonstrate a lateral resolution of 30 Å and a vertical resolution less than 1 Å.

PACS numbers: 68.35.Gy

Physical Review Letters **56**, 930 (1986)

A – Scanning Probe Micr. : historical context

- Non-contact Atomic Force Microscopy (nc-AFM), so-called Frequency Modulation AFM :
 - Developed in 1991 by the Almaden IBM research Lab. (USA)
 - Regular AFM (contact mode) spin-off

Frequency modulation detection using high- Q cantilevers for enhanced force microscope sensitivity

T. R. Albrecht, P. Grütter, D. Horne, and D. Rugar
 IBM Research Division, Almaden Research Center, 650 Harry Road, San Jose, California 95120

(Received 17 September 1990; accepted for publication 28 September 1990)

A new frequency modulation (FM) technique has been demonstrated which enhances the sensitivity of attractive mode force microscopy by an order of magnitude or more. Increased sensitivity is made possible by operating in a moderate vacuum ($< 10^{-3}$ Torr), which increases the Q of the vibrating cantilever. In the FM technique, the cantilever serves as the frequency determining element of an oscillator. Force gradients acting on the cantilever cause instantaneous frequency modulation of the oscillator output, which is demodulated with a FM detector. Unlike conventional "slope detection," the FM technique offers **increased sensitivity** through increased Q without restricting system bandwidth. Experimental comparisons of FM detection in vacuum ($Q \sim 50\,000$) versus slope detection in air ($Q \sim 100$) demonstrated an improvement of more than 10 times in sensitivity for a fixed bandwidth. This improvement is evident in images of magnetic transitions on a thin-film CoPtCr magnetic disk. In the future, the increased sensitivity offered by this technique should extend the range of problems accessible by force microscopy.

J. Applied Physics **69(2)**, 668 (1991)

- First nc-AFM image with atomic resolution reported in 1995 on the Si(111)7x7 surface :

« Atomic resolution of the Si(111) 7x7 surface by atomic force microscopy »

F. Giessibl, Science **267**, 68 (1995)

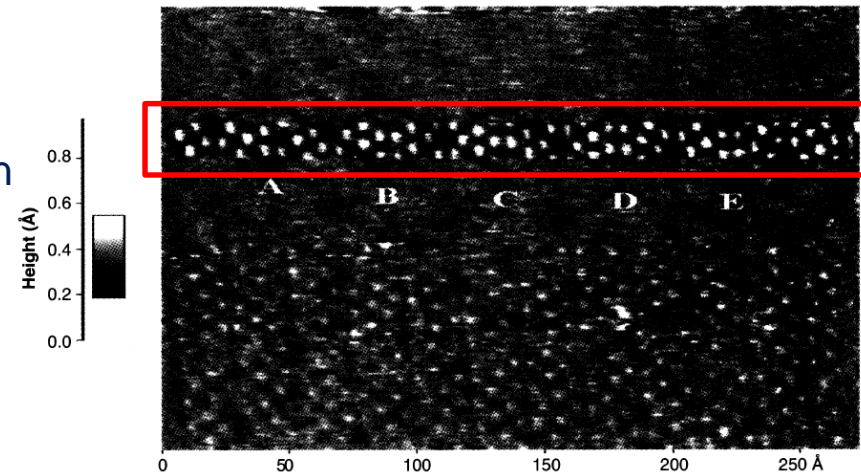

Outline

A. Scanning Probe Microscopies: historical context

B. Ultra-High Vacuum environment

C. AFM in 4 steps (contact mode concept)

D. Dynamic AFM

E. Non-contact AFM

B- Ultra-High Vacuum environment

- Investigating surface physics processes down to atomic scale requires :
 - To have sample preparation methods with atomic-scale control
 - To perform the sample preparation within a clean environment to keep it clean over a long-enough duration (no humidity, no external contaminants...)
 - To perform SPM experiments within that laps of time

B- Ultra-High Vacuum environment

- Investigating surface physics processes down to atomic scale requires :
 - To have sample preparation methods with atomic-scale control
 - To perform the sample preparation within a clean environment to keep it clean over a long-enough duration (no humidity, no external contaminants...)
 - To perform SPM experiments within that laps of time



Low pressure environment = Ultra-High Vacuum (UHV) $\sim 10^{-10}$ mbar

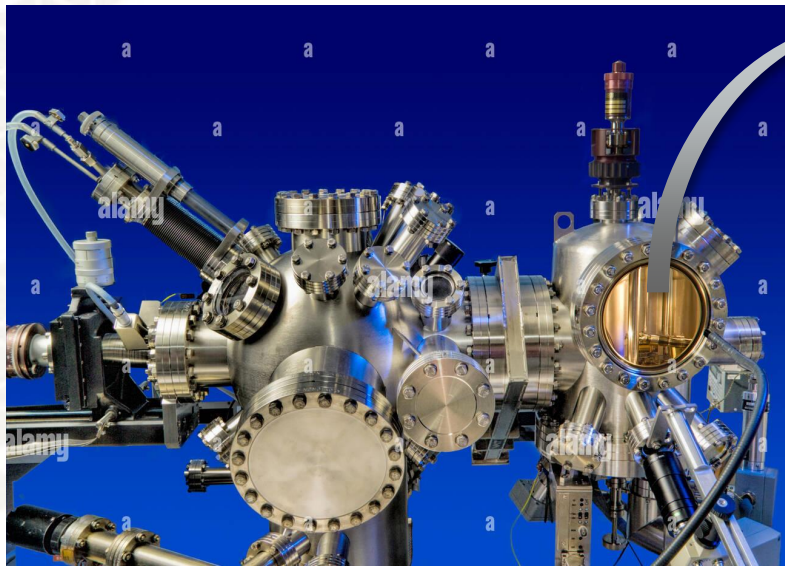

AFM / STM
(room temperature, or low temperature)



B- Ultra-High Vacuum environment

- A good starting point : ideal gas law

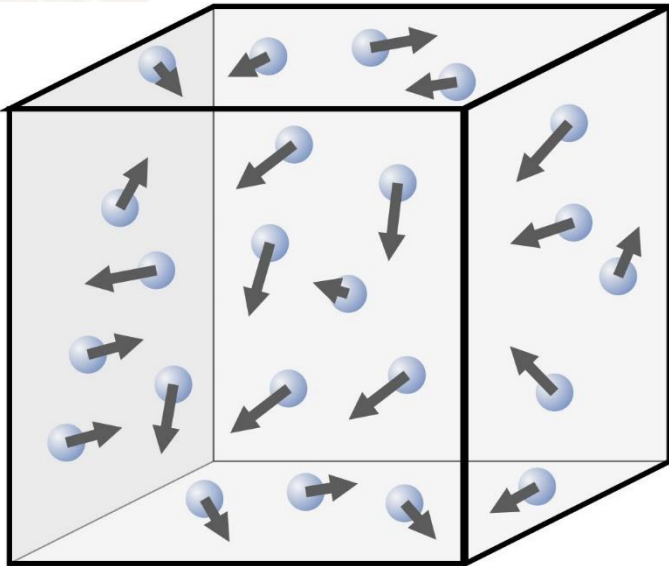

*Gas molecules confined
within a tank with a random
speeds distribution defining an
averaged temperature T*



B- Ultra-High Vacuum environment

- A good starting point : ideal gas law

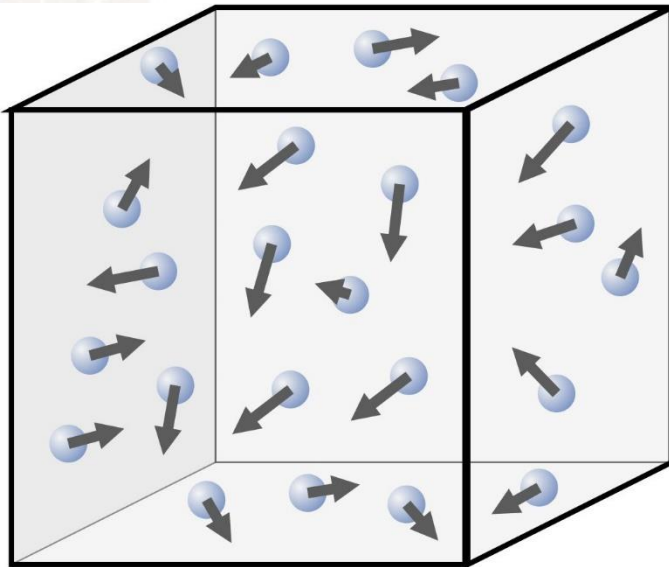

Gas molecules confined within a tank with a random speeds distribution defining an averaged temperature T

$$PV = nRT \quad (\text{Equ.01})$$

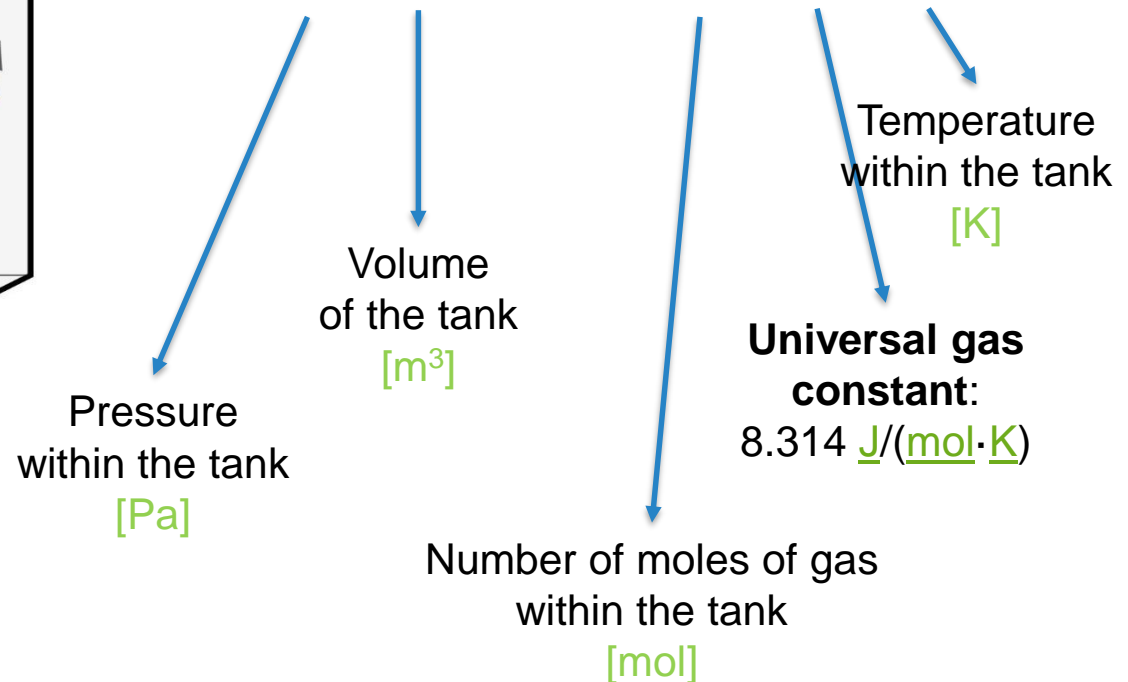



B- Ultra-High Vacuum environment

- A good starting point : ideal gas law

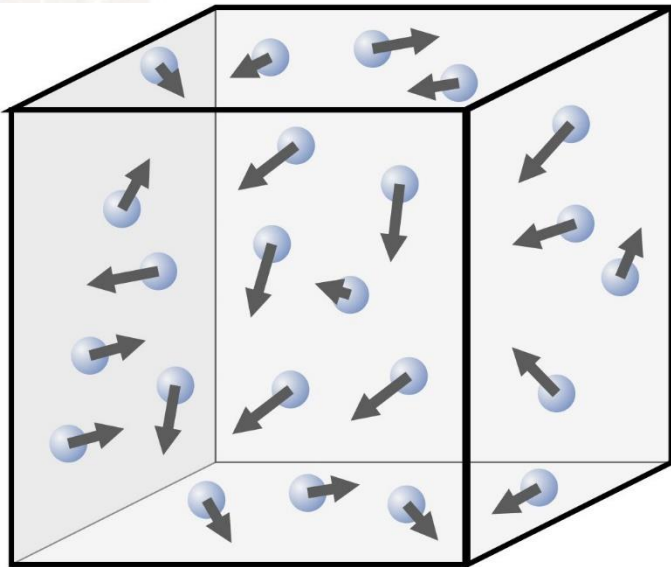

Gas molecules confined within a tank with a random speeds distribution defining an averaged temperature T

$$PV = nRT \quad (\text{Equ.01})$$

Upon **standard conditions of pressure and temperature:**

- $P = 1013 \text{ hPa} = 1 \text{ atm.} = 1013 \text{ mbar} = 770 \text{ Torr}$
- $T = 25 \text{ }^\circ\text{C} = 298 \text{ K}$

One mole of gas ($n = 1$, i.e. $N = n \times N_A = 6.02 \cdot 10^{23}$ atoms) occupies a volume:

$$V = 24.4 \text{ l} = 24.4 \text{ dm}^3$$

Density : $\sim 2.5 \cdot 10^{19} \text{ at./cm}^3$



B- Ultra-High Vacuum environment

- Pumping down the tank at **constant volume** and **constant temperature** :

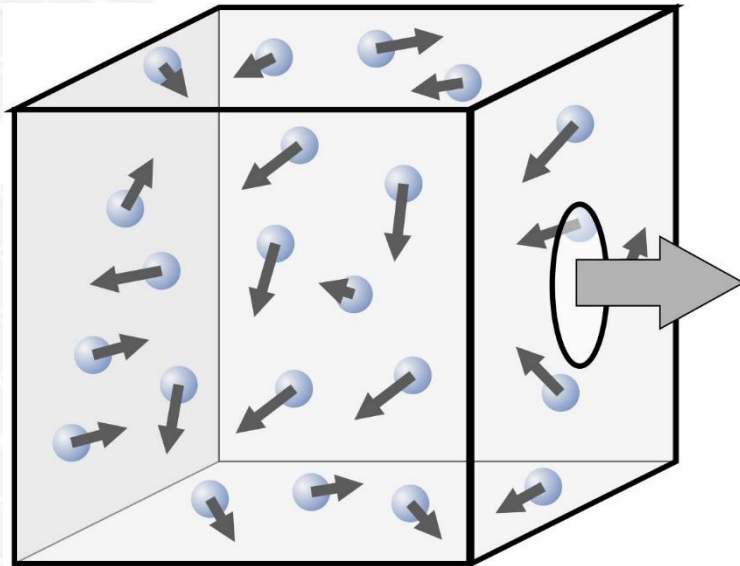

Gas molecules confined within a tank with a random speeds distribution defining an averaged temperature T

$$PV = nRT \quad (\text{Equ.01})$$

Pumping flow
(pumping methods won't be detailed here)



B- Ultra-High Vacuum environment

- Vacuum regimes :

Rough vacuum

Atm. pressure – 10^{-4} mbar

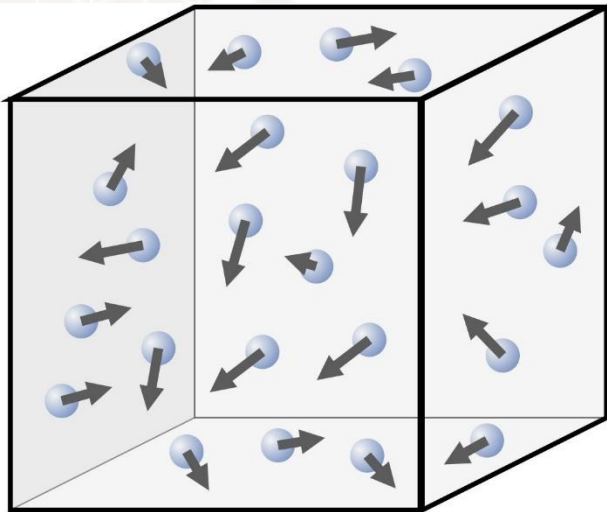

density : $2.5 \cdot 10^{12}$ at./cm³

High vacuum

10^{-4} – 10^{-8} mbar

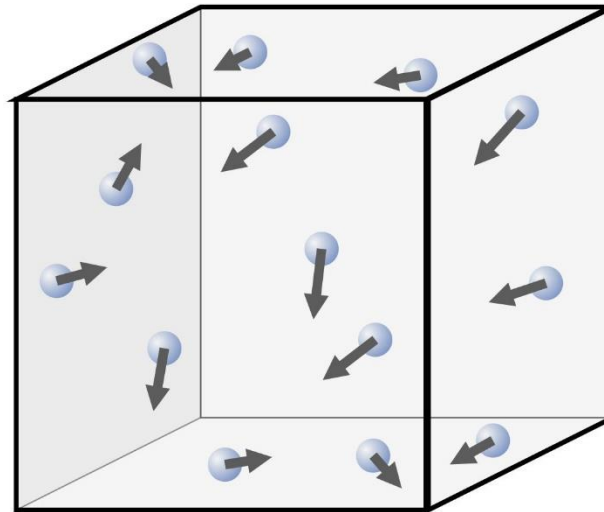

density : $2.5 \cdot 10^8$ at./cm³

Ultra-high vacuum

10^{-8} – 10^{-11} mbar

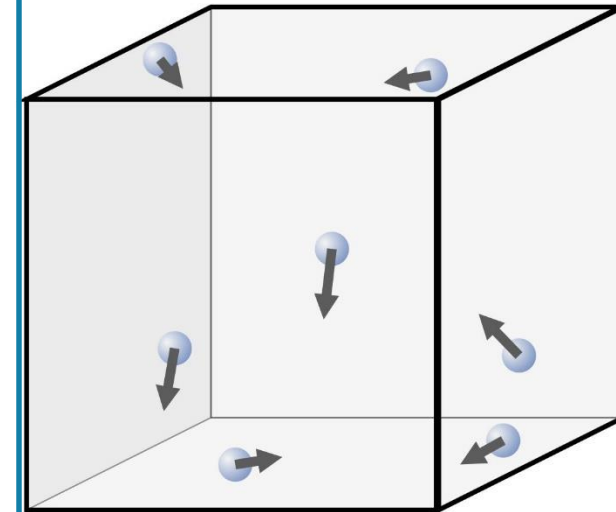

density : $2.5 \cdot 10^5$ at./cm³



B- Ultra-High Vacuum environment

- Langmuir (L) : residual gas monolayer

$$1 \text{ L} := 10^{-6} \text{ Torr} \times 1 \text{ s} \sim 10^{-6} \text{ mbar} \times 1 \text{ s}$$

High Vacuum (HV)

$4 \cdot 10^{-6}$ mbar

1 residual gas monolayer
every 4 SECONDS

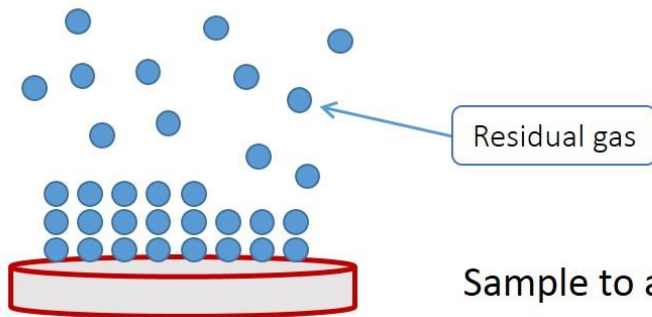

Ultra High Vacuum (UHV)

$4 \cdot 10^{-11}$ mbar

1 residual gas monolayer
a DAY

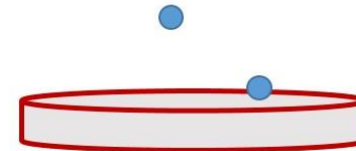



B- Ultra-High Vacuum environment

- UHV allows the samples to be kept clean at the atomic scale over couple of days, which permits SPM experiments to be performed
- From **room** down to **low temperature** (RT/LT):

$$PV = nRT$$

Assume a UHV & **room temperature** ($T_1=298$ K) regime:

- $P_1 = 4 \cdot 10^{-11}$ mbar \rightarrow 1 L / day



B- Ultra-High Vacuum environment

- UHV allows the samples to be kept clean at the atomic scale over couple of days, which permits SPM experiments to be performed
- From **room** down to **low temperature** (RT/LT):

$$PV = nRT$$

Assume a UHV & **room temperature** ($T_1 = 298 \text{ K}$) regime:

- $P_1 = 4 \cdot 10^{-11} \text{ mbar} \rightarrow 1 \text{ L / day}$

At **liquid nitrogen** ($T_2 = 77 \text{ K}$):

- $P_2 = P_1 \times T_2 / T_1 = 10^{-11} \text{ mbar} \rightarrow 1 \text{ L / 4 days}$

At **liquid helium** ($T_3 = 4 \text{ K}$):

- $P_3 = P_1 \times T_3 / T_1 = 5.3 \cdot 10^{-13} \text{ mbar} \rightarrow 1 \text{ L / 20 days}$



B- Ultra-High Vacuum environment

- A prototypical UHV SPM setup:

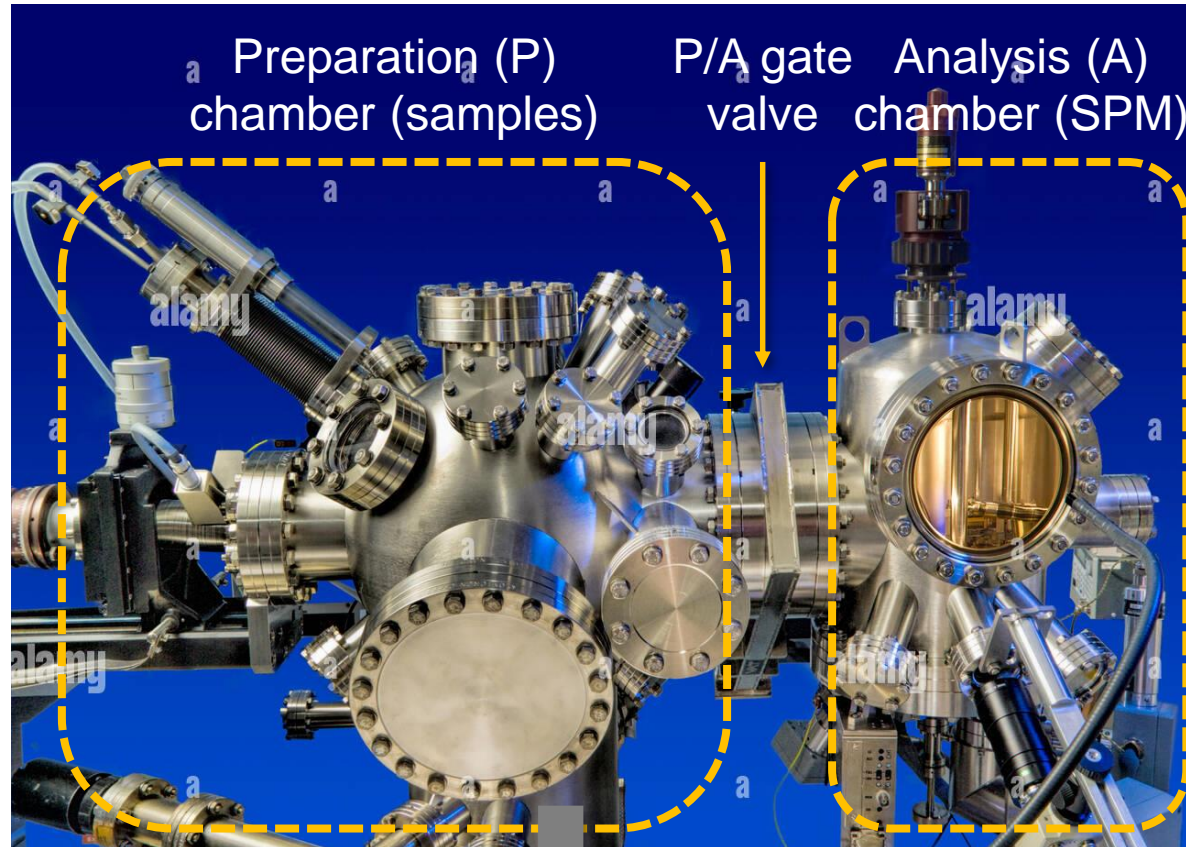

Pumping flow

UHV environment : summary

- UHV $\sim 10^{-10}$ mbar (NB: ambient pressure = 1013 mbar)
- Allows the samples to be kept clean at the atomic scale over couple of days, which permit SPM experiments to be performed with atomic sensitivity
- SPM experiments in UHV can either be carried out at **room temperature (298 K)**, or **low temperature (LN₂ 77 K, LHe 4 K)**
- Requires a dedicated setup (UHV chambers, cryostats, pumps, preparation stages, manipulators...)

Outline

A. Scanning Probe Microscopies: historical context

B. Ultra-High Vacuum environment

C. AFM in 4 steps (contact mode concept)

D. Dynamic AFM

E. Non-contact AFM

C – AFM in 4 steps (contact mode concept)

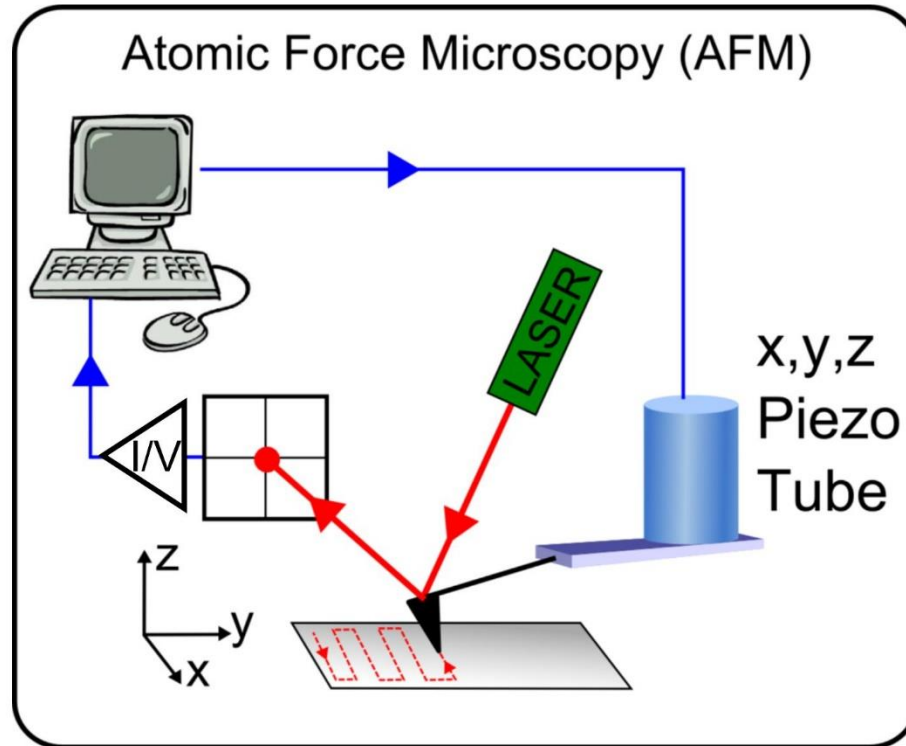

C – AFM in 4 steps (contact mode concept)

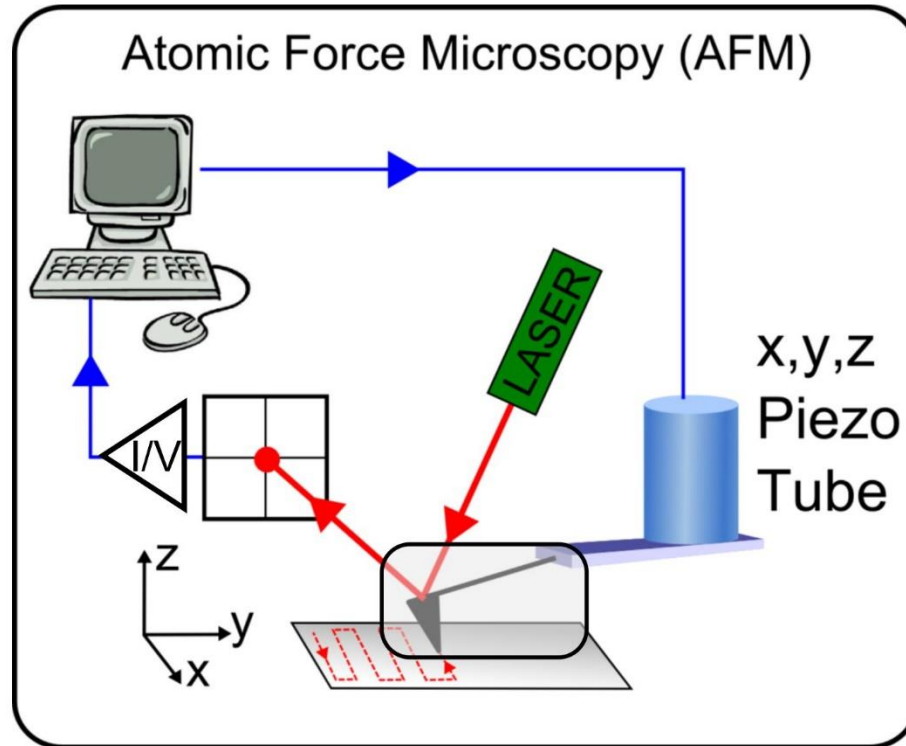

1- The probe

C – AFM in 4 steps (contact mode concept)

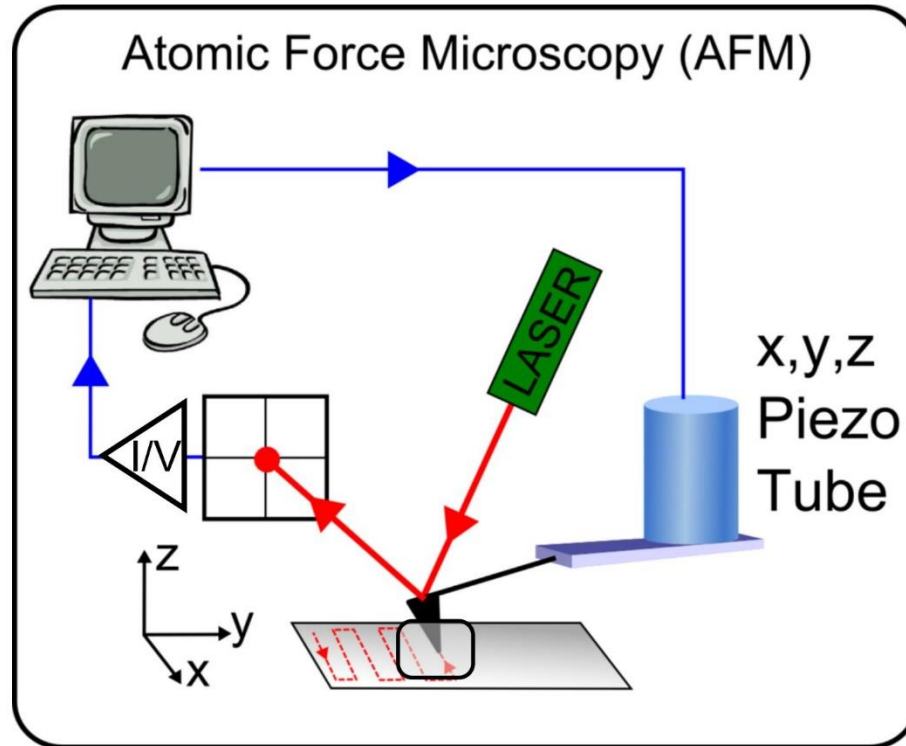

- 1- The probe
- 2- Tip-surface interaction forces

C – AFM in 4 steps (contact mode concept)

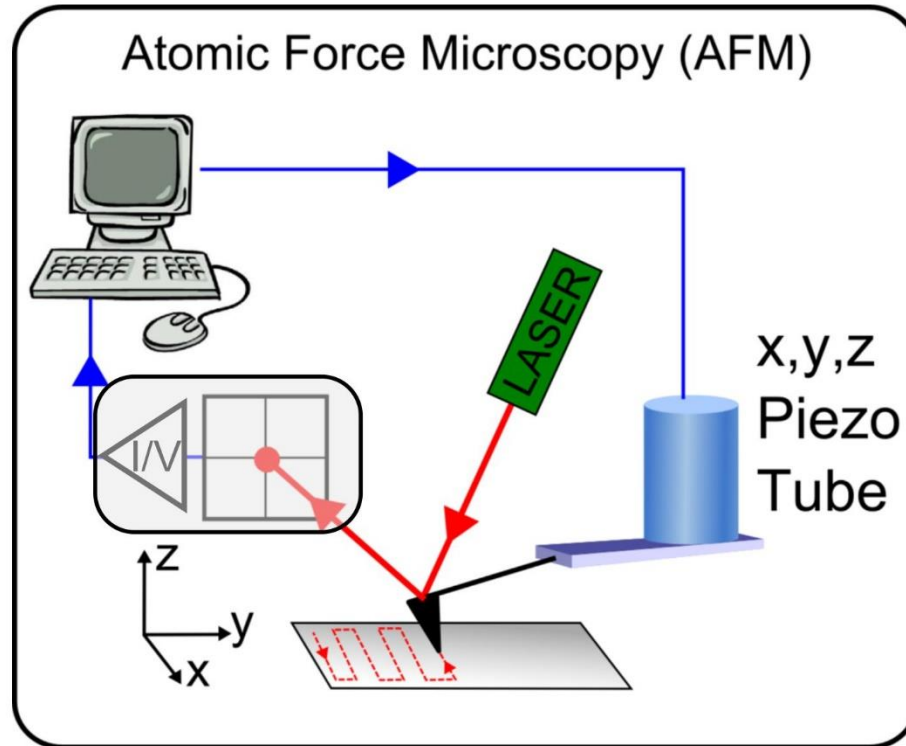

- 1- The probe
- 2- Tip-surface interaction forces
- 3- Detecting the interaction forces

C – AFM in 4 steps (contact mode concept)

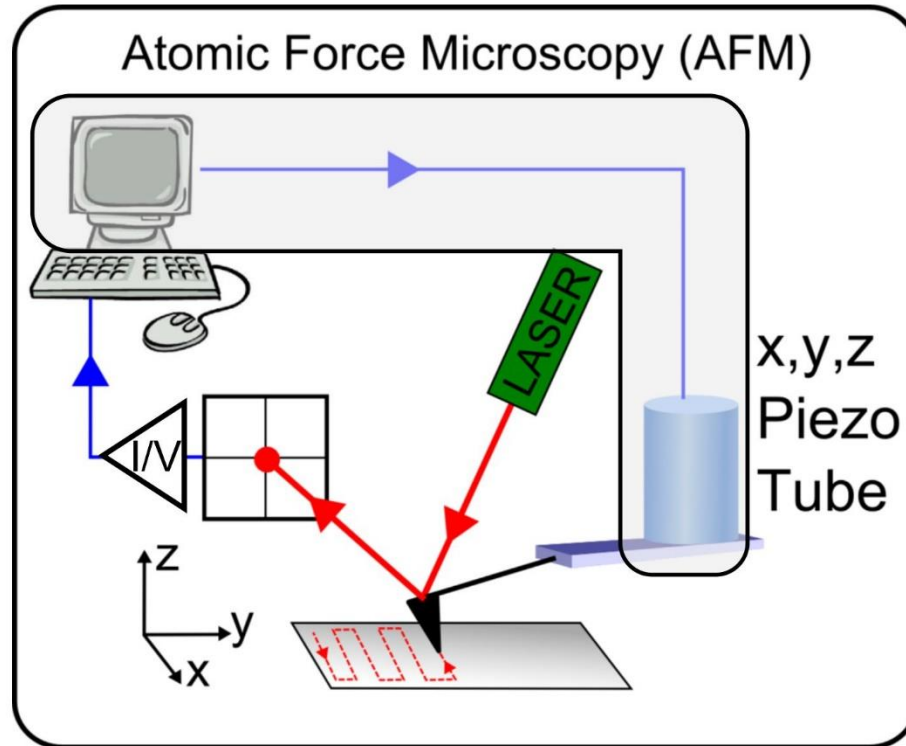

- 1- The probe
- 2- Tip-surface interaction forces
- 3- Detecting the interaction forces
- 4- Scanning & feedback

C – AFM in 4 steps (contact mode concept)

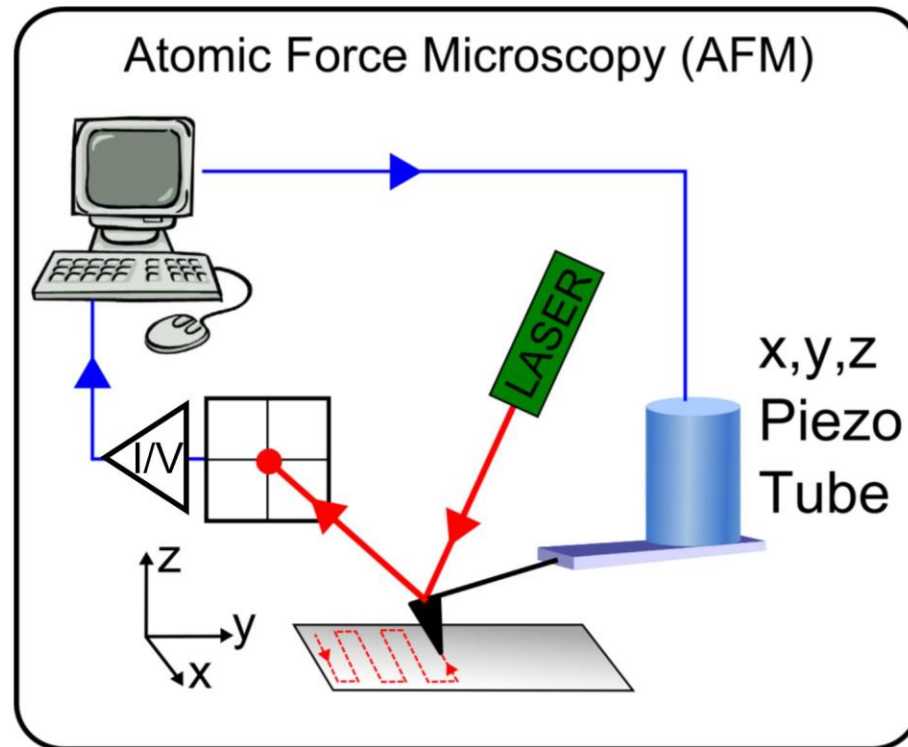

- 1- The probe
- 2- Tip-surface interaction forces
- 3- Detecting the interaction forces
- 4- Scanning & feedback

Operation modes:

Static
(Contact)



Dynamic
(Tapping & nc-AFM)

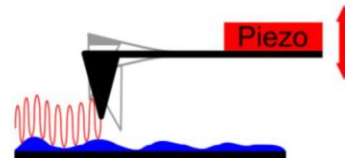

Force spectroscopy

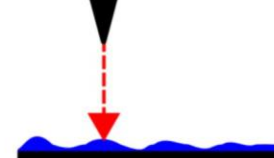

C – AFM in 4 steps (contact mode concept)

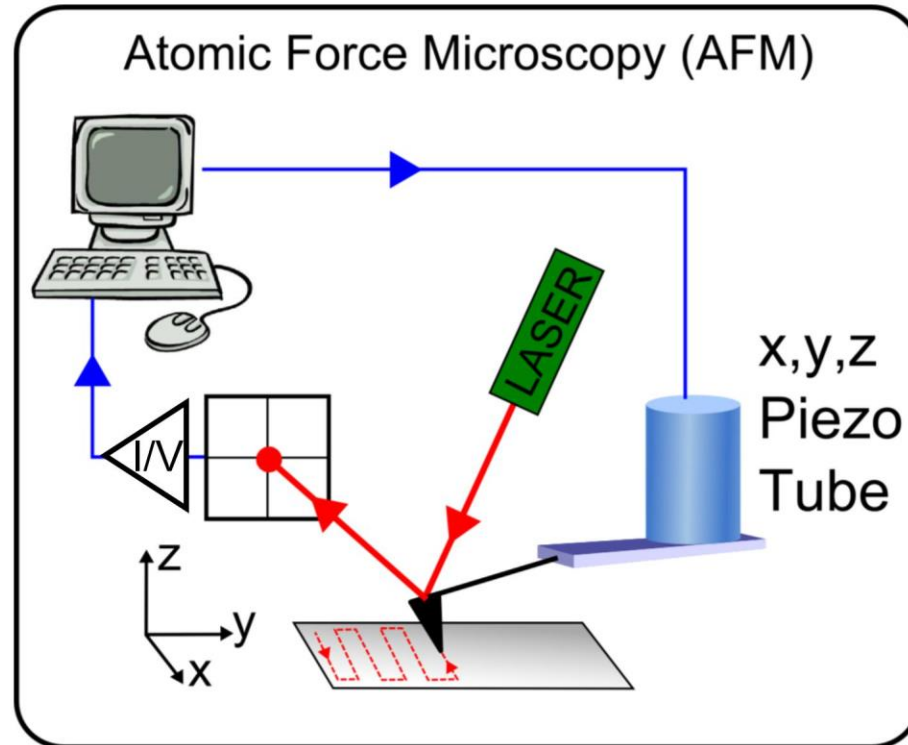

- 1- The probe
- 2- Tip-surface interaction forces
- 3- Detecting the interaction forces
- 4- Scanning & feedback

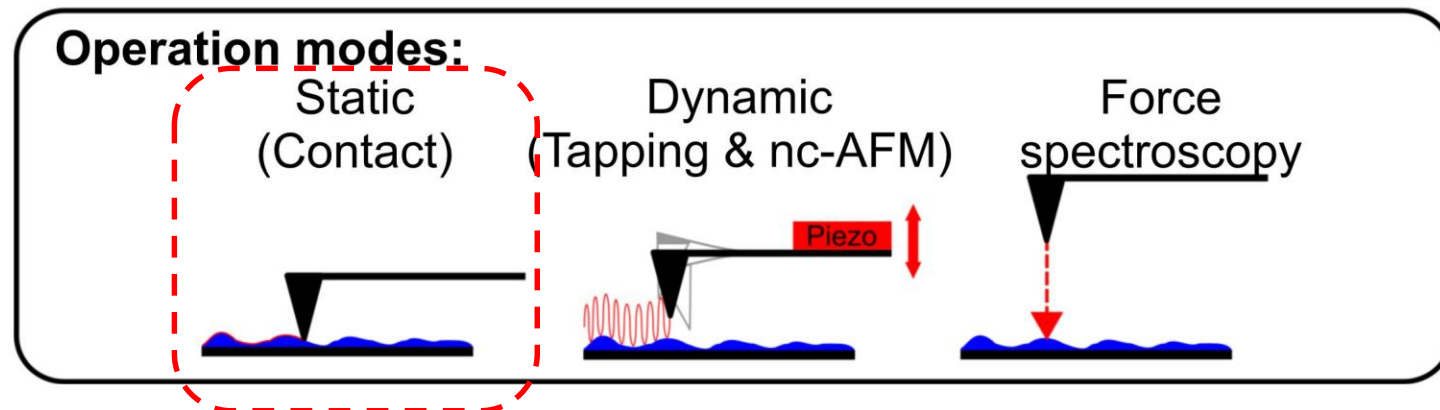

C – AFM in 4 steps (contact mode concept)

1. The probe:
 - a. Cantilever
 - b. Quartz tuning fork
2. Tip-surface interaction forces
3. Detecting the tip-surface interaction force:
 - a. Cantilever
 - b. Quartz tuning fork
4. Surface scanning and feedback

C1- The probe

- **AFM = scanning probe technic** (nano-tip close to a surface): tip is located at the end of a micro-lever that can either be a **cantilever**, or a **Quartz Tuning Fork (QTF)**

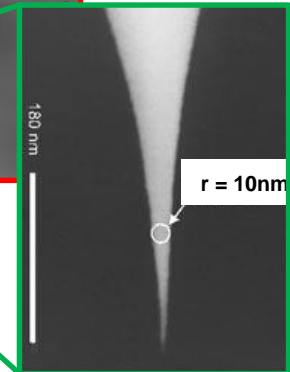
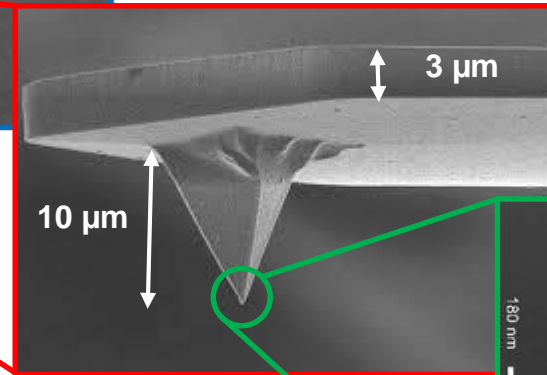
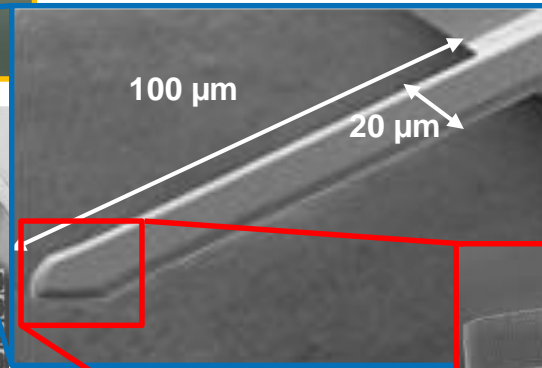
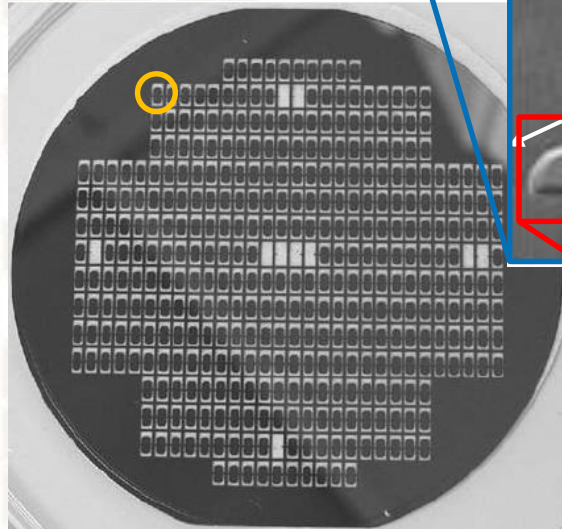

Manufacturers:

- Nanosensors: <https://www.nanosensors.com>
- Nanoandmore: <https://www.nanoandmore.com>
- Nanoworld: <https://www.nanoworld.com/>
- ...

Silicon wafer → lithography methods →
Integrated tip-cantilever mechanical system

C1- The probe

- **AFM = scanning probe technic** (nano-tip close to a surface): tip is located at the end of a micro-lever = this can either be a **cantilever**, or a **Quartz Tuning Fork (QTF)**

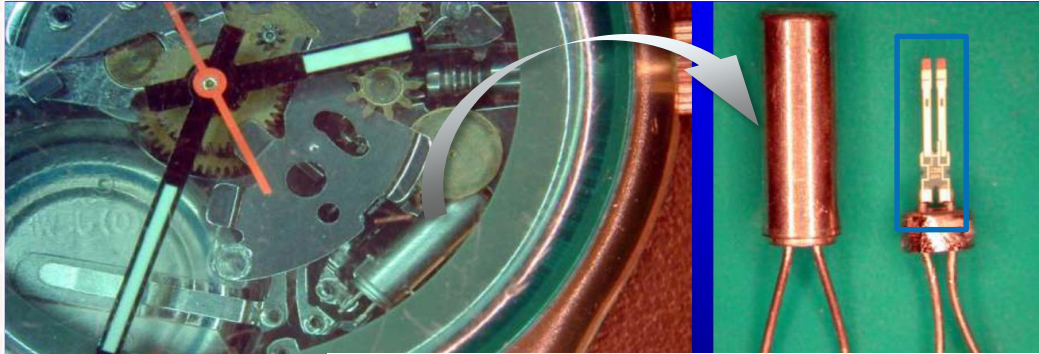

Quartz crystal (piezoelectric material) → cutting according to watch industry methods → QTF

QTF applied to nc-AFM:

- The tip consists in a PtIr or W chemically-etched wire that is glued at the end of one of the QTF's prongs
- qPlus™ sensor concept¹

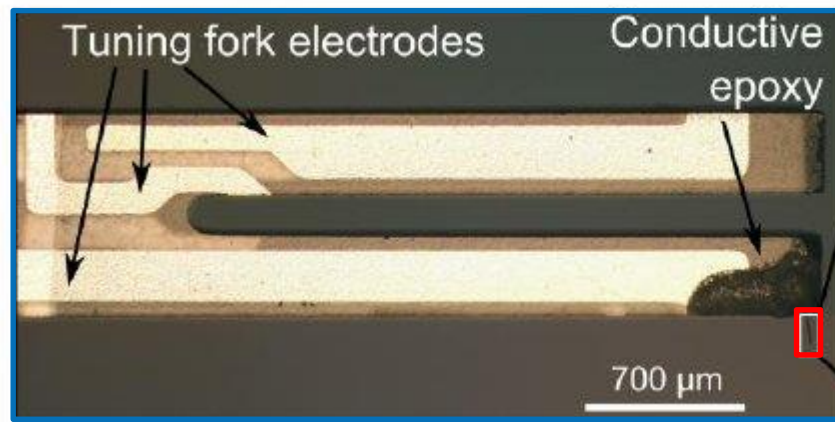
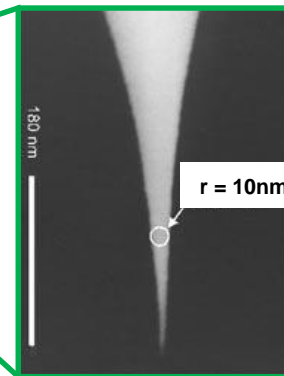

Image after ²



¹F.Giessibl, Appl.PhysLett. **76**, 1470 (2000); *Science* **267**, 68 (1995)

²A. Castellanos-Gomez *et al.* Scanning Probe Microscopy in Nanoscience and Nanotechnology 3, 23-53 (2013)



Reference / review papers & books

- “The qPlus sensor, a powerful core for the atomic force microscope”
F. Giessibl, Rev. Sci. Instrum. **90**, 011101 (2019)

C1- The probe

- **AFM = scanning probe technic** (nano-tip close to a surface): tip is located at the end of a micro-lever = **cantilever / QTF**
- **Mechanical analogy** for the tip-microlever system : **oscillator** of stiffness k_0 , resonance frequency of the fundamental bending mode f_0 subject to an interaction force F_{int} with the sample surface

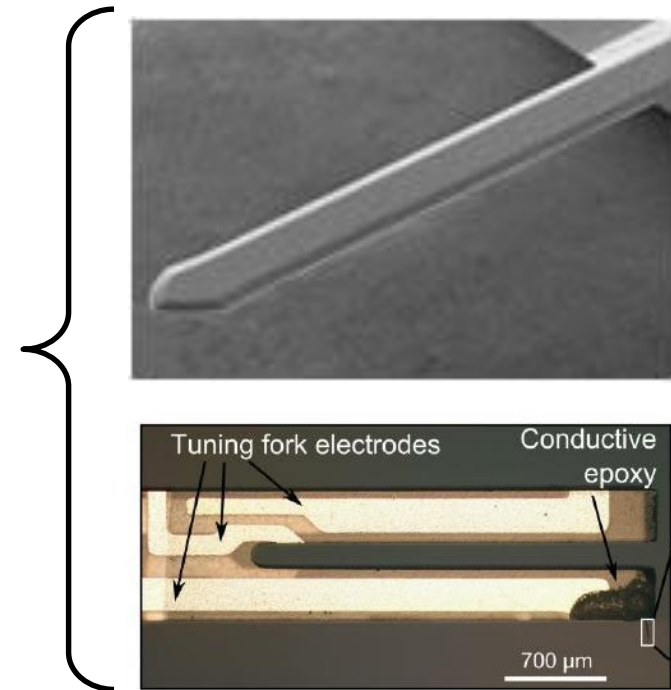
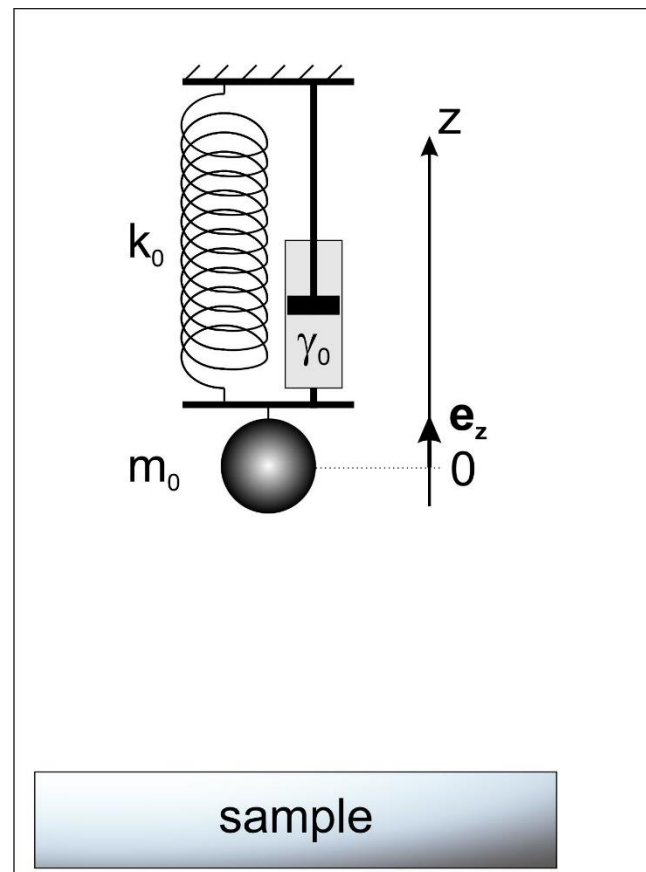

C1- The probe

- **AFM = scanning probe technic** (nano-tip close to a surface): tip is located at the end of a micro-lever = **cantilever / QTF**
- **Mechanical analogy** for the tip-microlever system : **oscillator** of stiffness k_0 , resonance frequency of the fundamental bending mode f_0 subject to an interaction force F_{int} with the sample surface

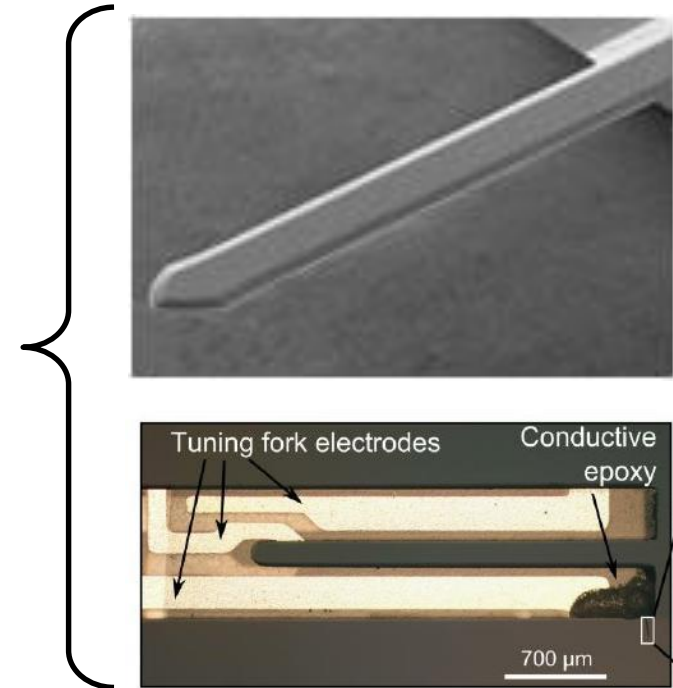
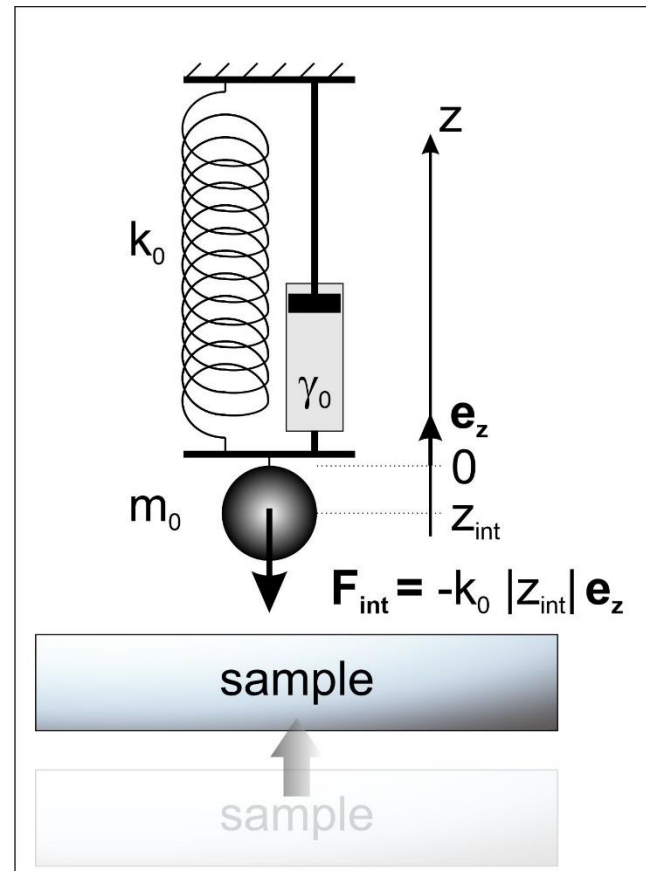

C1- The probe

- **AFM = scanning probe technic** (nano-tip close to a surface): tip is located at the end of a micro-lever = **cantilever / QTF**
- **Mechanical analogy** for the tip-microlever system : **oscillator** of stiffness k_0 , resonance frequency of the fundamental bending mode f_0 subject to an interaction force \mathbf{F}_{int} with the sample surface

- Thus, measuring \mathbf{F}_{int} “resumes to measuring the tip deflection z_{int} ” (upon k_0 calibration)

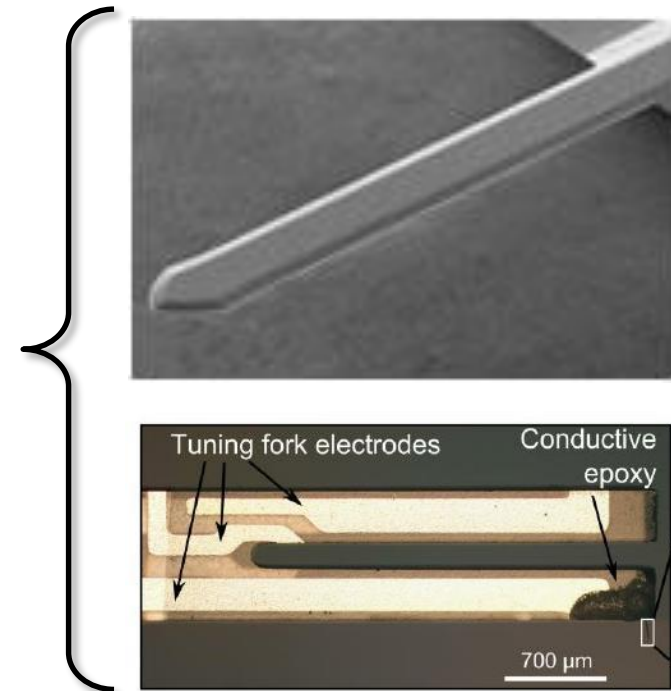
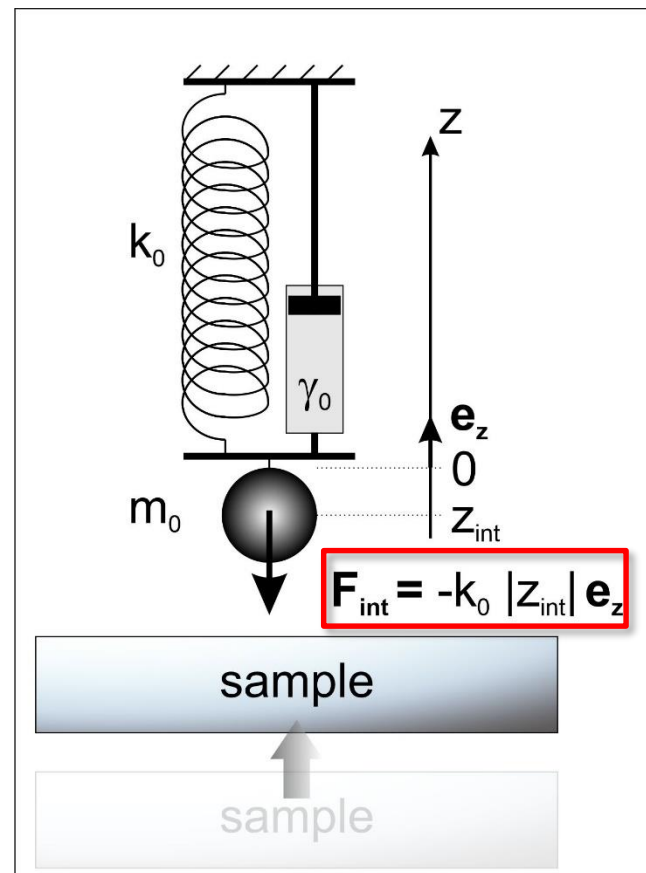

C1- The probe

- **AFM = scanning probe technic** (nano-tip close to a surface): tip is located at the end of a micro-lever = **cantilever / QTF**
- **Mechanical analogy** for the tip-microlever system : **oscillator**
frequency
- **Technical implementation** of the probes for nc-AFM applications in UHV :

Cantilevers

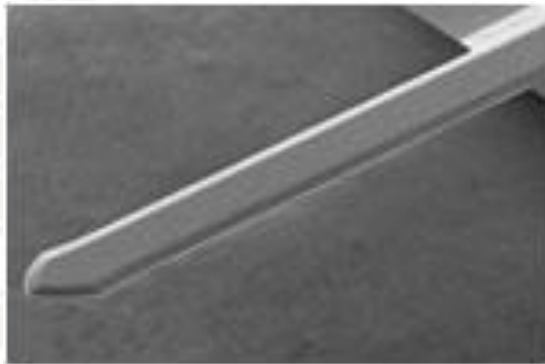

- Mostly used at **room temperature (298 K)**
- Wide range of resonance frequencies
- Wide range of stiffnesses
- Detection of the tip deflection demanding in UHV

C1- The probe

- **AFM = scanning probe technic** (nano-tip close to a surface): tip is located at the end of a micro-lever = **cantilever / QTF**
- **Mechanical analogy** for the tip-microlever system : **oscillator**
frequency
- **Technical implementation** of the probes for nc-AFM applications in UHV :

Cantilevers

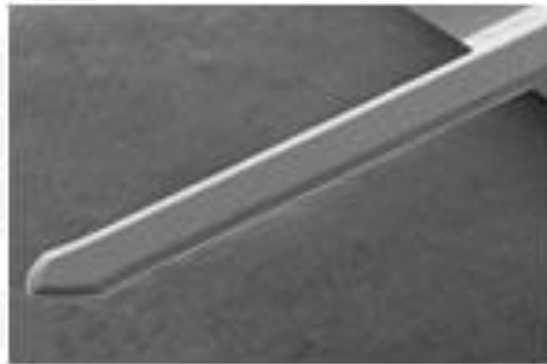

- Mostly used at **room temperature (298 K)**
- Wide range of resonance frequencies
- Wide range of stiffnesses
- Detection of the tip deflection demanding in UHV

Quartz tuning fork

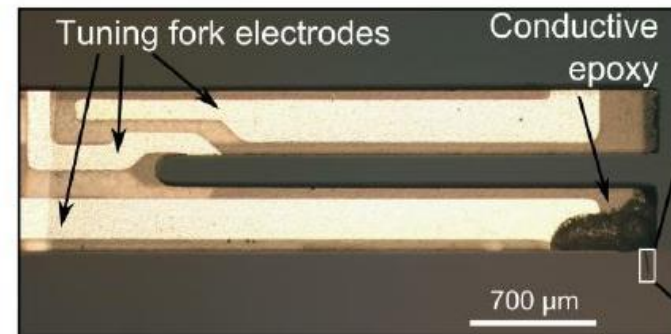

- Mostly used at **low temperature (4 K)**
- Narrow range of resonance frequencies
- Narrow range of stiffnesses
- Ease of detection of the tip deflection in UHV

C1- The probe

- **AFM = scanning probe technic** (nano-tip close to a surface): tip is located at the end of a micro-lever = **cantilever / QTF**
- **Mechanical analogy** for the tip-microlever system : **oscillator**
frequency
- **Technical implementation** of the probes for nc-AFM applications in UHV :

Cantilevers

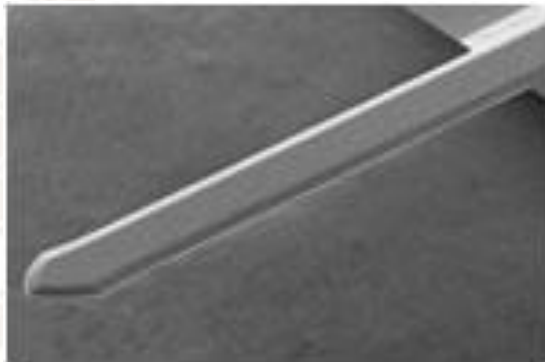

Orders of magnitude:

- Material: Silicon (mostly)
- Size: $(100 \times 20 \times 3) \mu\text{m}^3$
- Stiffness: 30 N/m ... 100 N/m
- Frequency: 50 kHz ... 1 MHz

The tip:

- Aspect ratio upon manufacturers
- Height: 10 μm
- Curvature radius: 5 nm (at best)

Quartz tuning fork

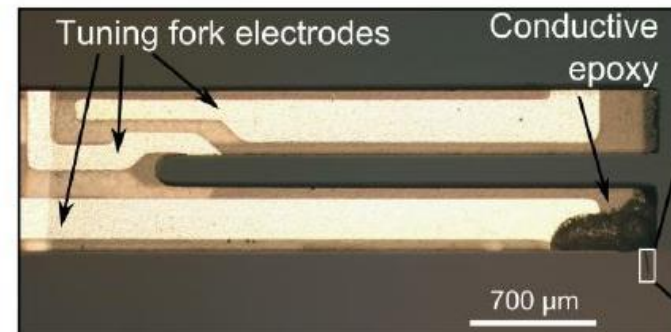

Orders of magnitude:

- Material: piezoelectric quartz
- Size: $(2.0 \times 1.5 \times 0.2) \text{mm}^3$
- Stiffness: 2000 N/m
- Frequency: 30 kHz

The tip:

- W, or PtIr etched wire
- Height: 100 μm
- Curvature radius: 5 nm (at best)

C – AFM in 4 steps (contact mode concept)

1. The probe:
 - a. Cantilever
 - b. Quartz tuning fork
2. Tip-surface interaction forces
3. Detecting the tip-surface interaction force:
 - a. Cantilever
 - b. Quartz tuning fork
4. Surface scanning and feedback

C2- Tip-surface interaction forces

- The **micro-lever deflection** is induced by **tip-surface interatomic forces**:
 - Orders of magnitude:
 - ✓ Strength: 0.1 pN..10 nN
 - ✓ Distances: 1 Å .. 10 nm
 - Derive from conservative interaction potentials
 - Nature:
 - ✓ **Van der Waals** (London, Debye, Keesom) : attractive, long-range (> 1 nm, classical description)
 - ✓ **Electrostatic** (due to charges or dipoles) : attractive/repulsive, long-range/short-range, but primarily attractive & long-range by capacitive influence (> 10 nm, classical description)
 - ✓ **Chemical** (interatomic) : attractive/repulsive, short-range (~ Å, classical / quantum description)
 - ✓ **Magnetic** : attractive/repulsive, long-range (> 10 nm, classic description)



Reference / review papers & books

- “Scanning probe microscopy: the lab on a tip” (E.Meyer, H.J. Hug, R. Bennewitz, Springer-Verlag Berlin Heidelberg 2004)
- “Intermolecular and surface forces, 3rd edition” (J.N.Israelachvili, Elsevier 2011)

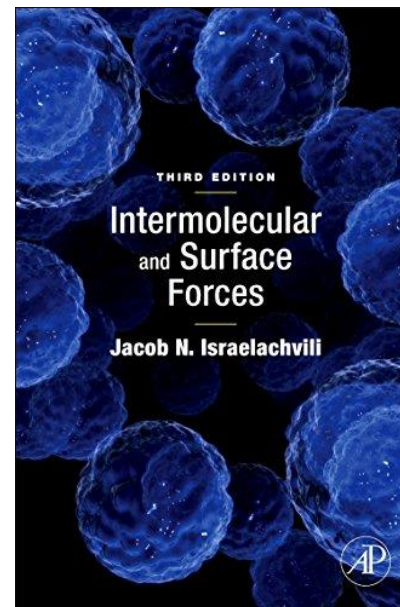
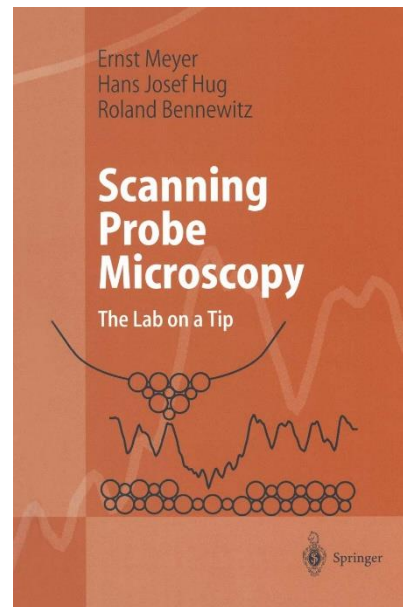

C2- Tip-surface interaction forces

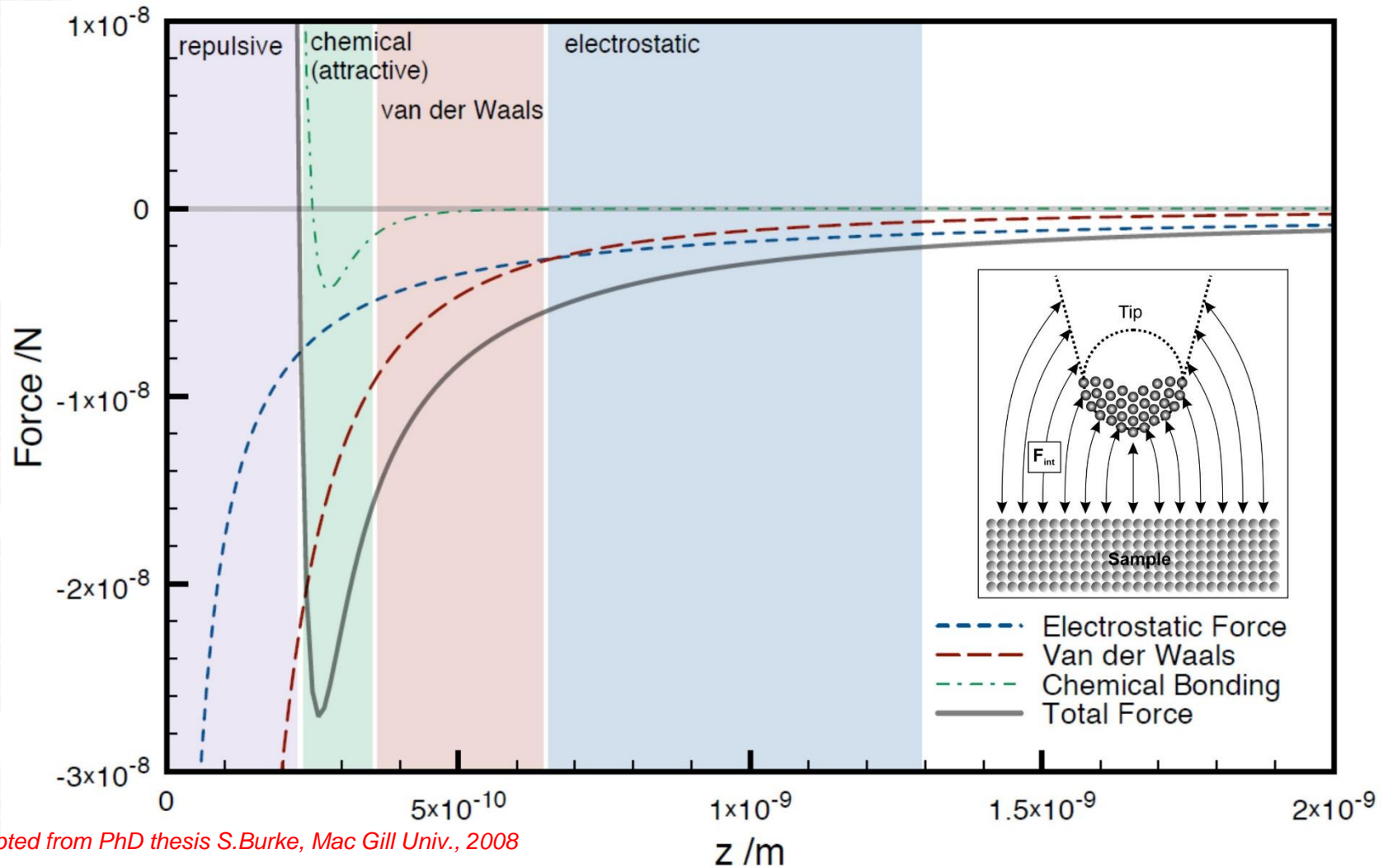

¹Adapted from PhD thesis S.Burke, Mac Gill Univ., 2008

C2- Tip-surface interaction forces

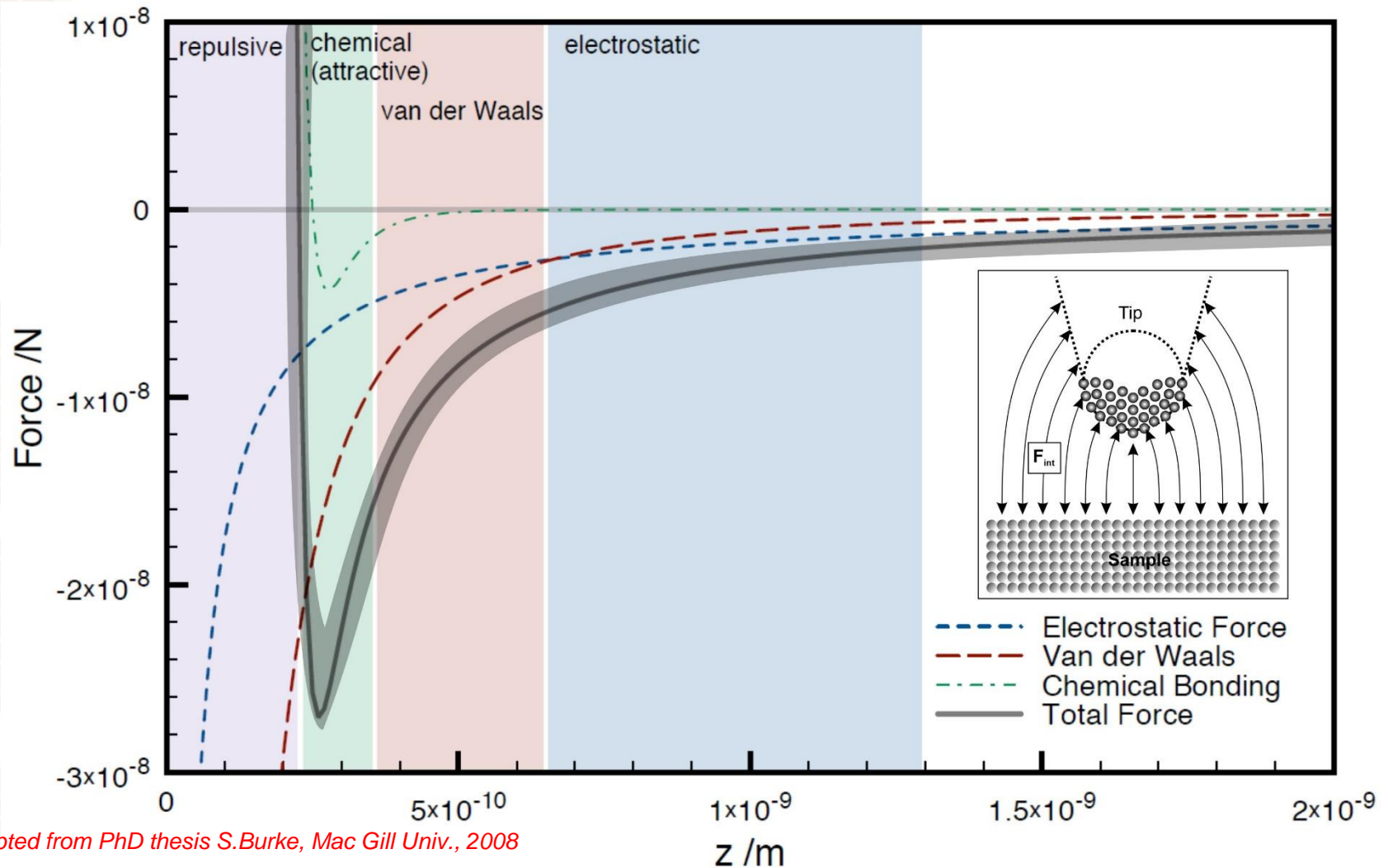

¹Adapted from PhD thesis S.Burke, Mac Gill Univ., 2008

C2- Tip-surface interaction forces

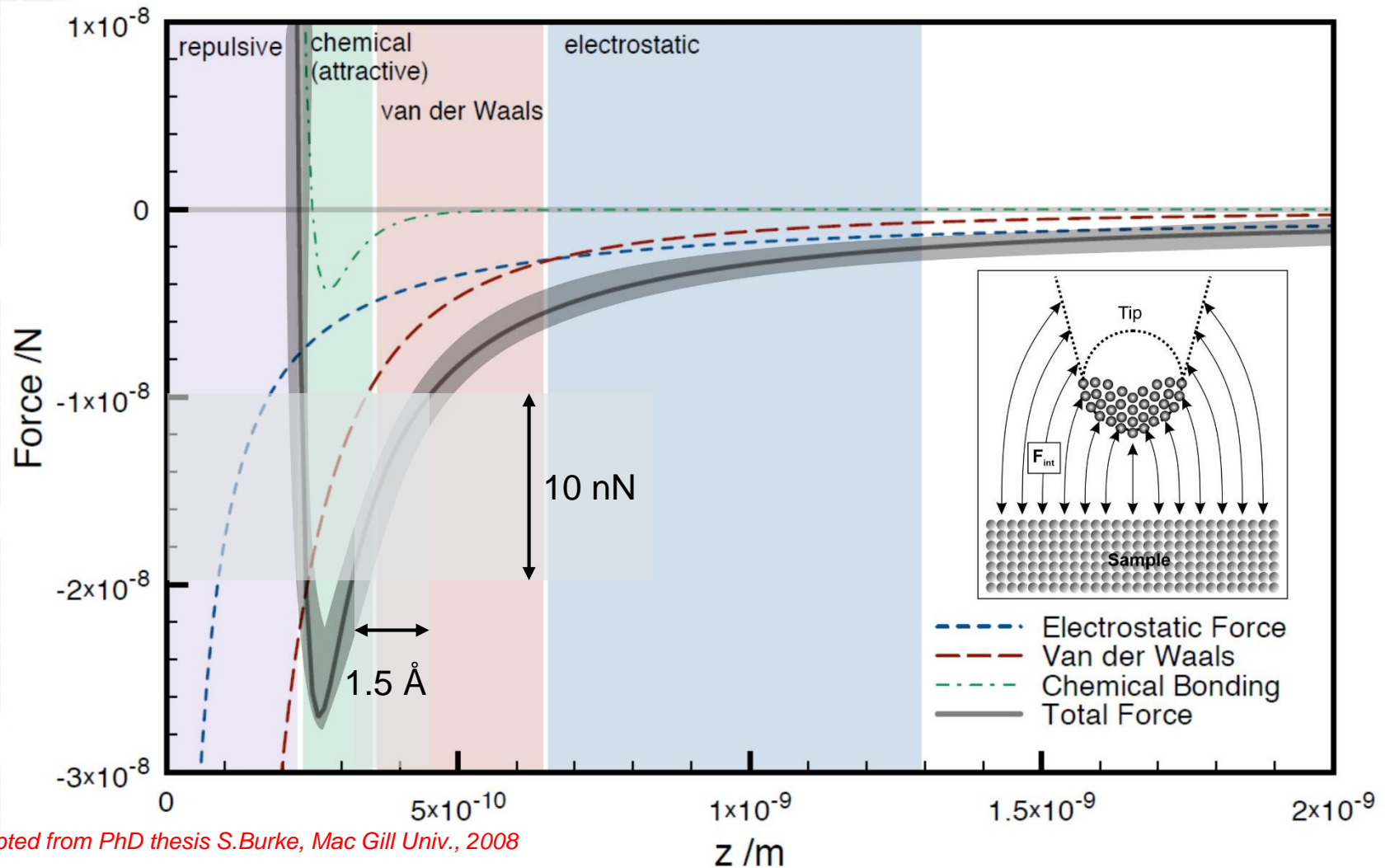

¹Adapted from PhD thesis S.Burke, Mac Gill Univ., 2008

C2- Tip-surface interaction forces

- The **micro-lever deflection** is induced by **tip-surface interatomic forces**:
 - Orders of magnitude:
 - ✓ Strength: 1 pN..10 nN
 - ✓ Distances: 1 Å .. 10 nm
 - Derive from conservative interaction potentials
 - Nature:
 - ✓ **Van der Waals** (London, Debye, Keesom) : attractive, long-range (> 1 nm, classical description)
 - ✓ **Electrostatic** (due to charges or dipoles) : attractive/repulsive, long-range/short-range, but primarily attractive & long-range by capacitive influence (> 10 nm, classical description)
 - ✓ **Chemical** (interatomic) : attractive/repulsive, short-range (~ Å, classical / quantum description)
 - ✓ **Magnetic** : attractive/repulsive, long-range (> 10 nm, classic description)

C2- Tip-surface interaction forces

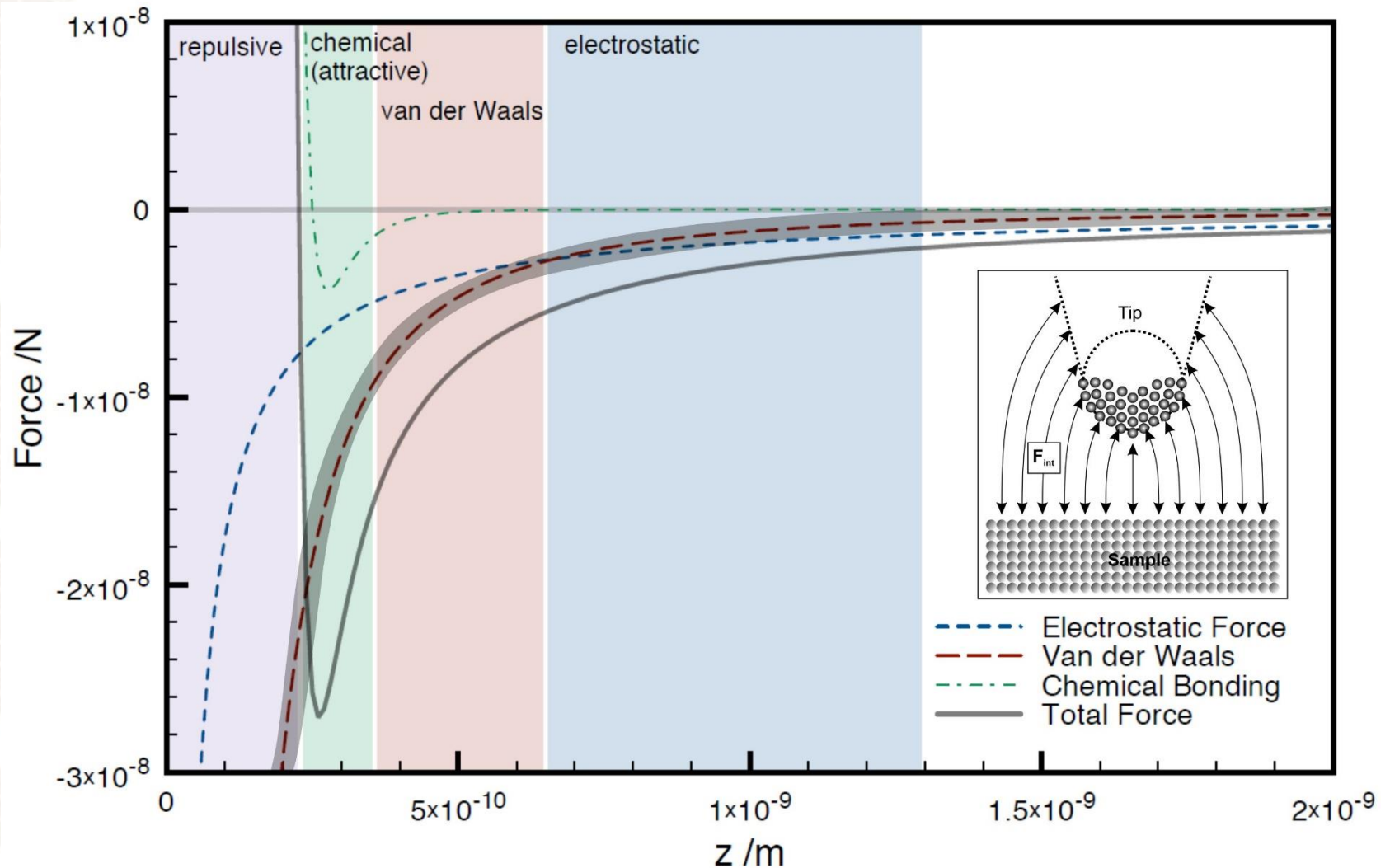

C2- Tip-surface interaction forces

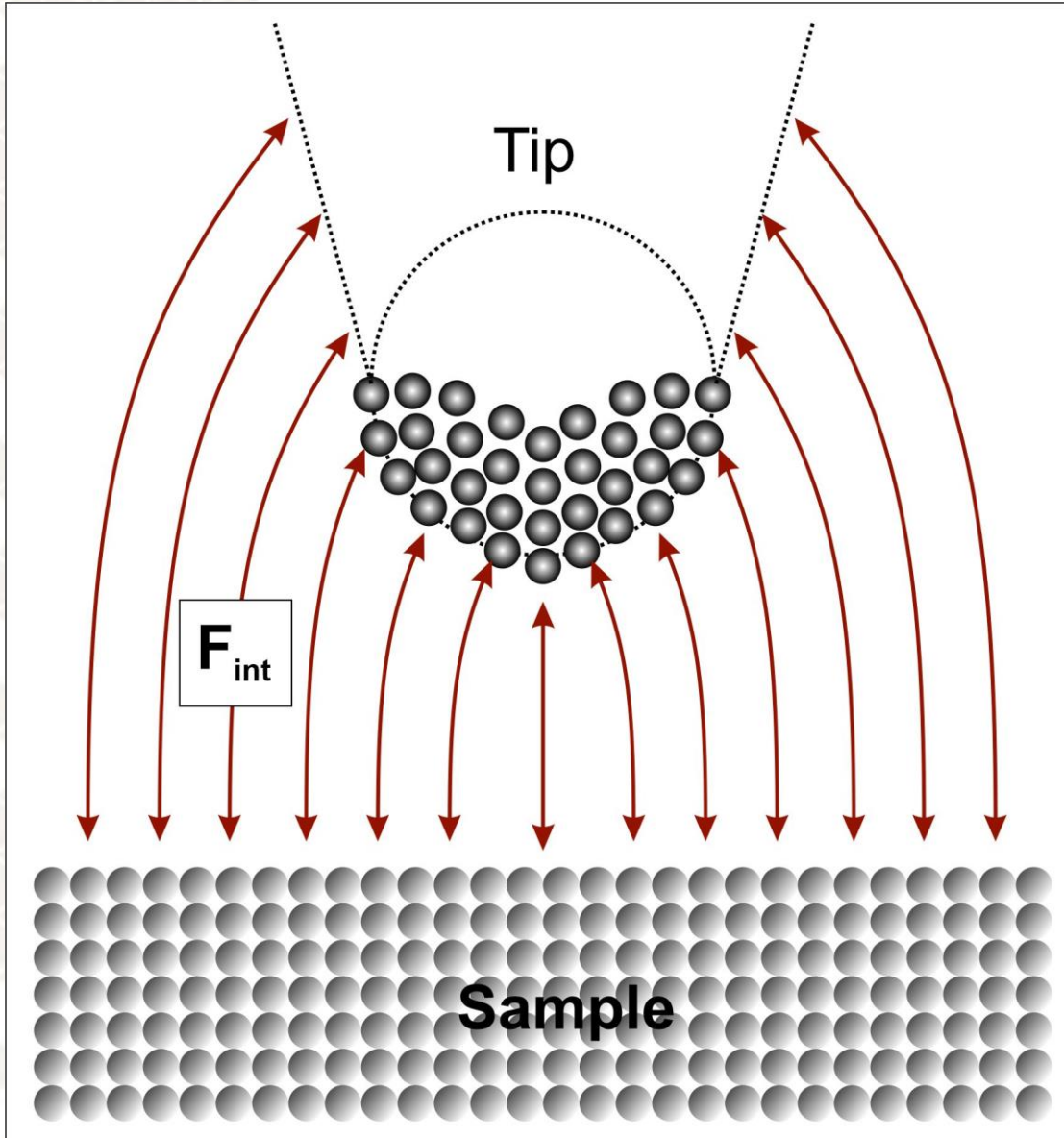

- **VdW forces** are **attractive** forces and arise between face to face surfaces in the nm range and beyond

C2- Tip-surface interaction forces

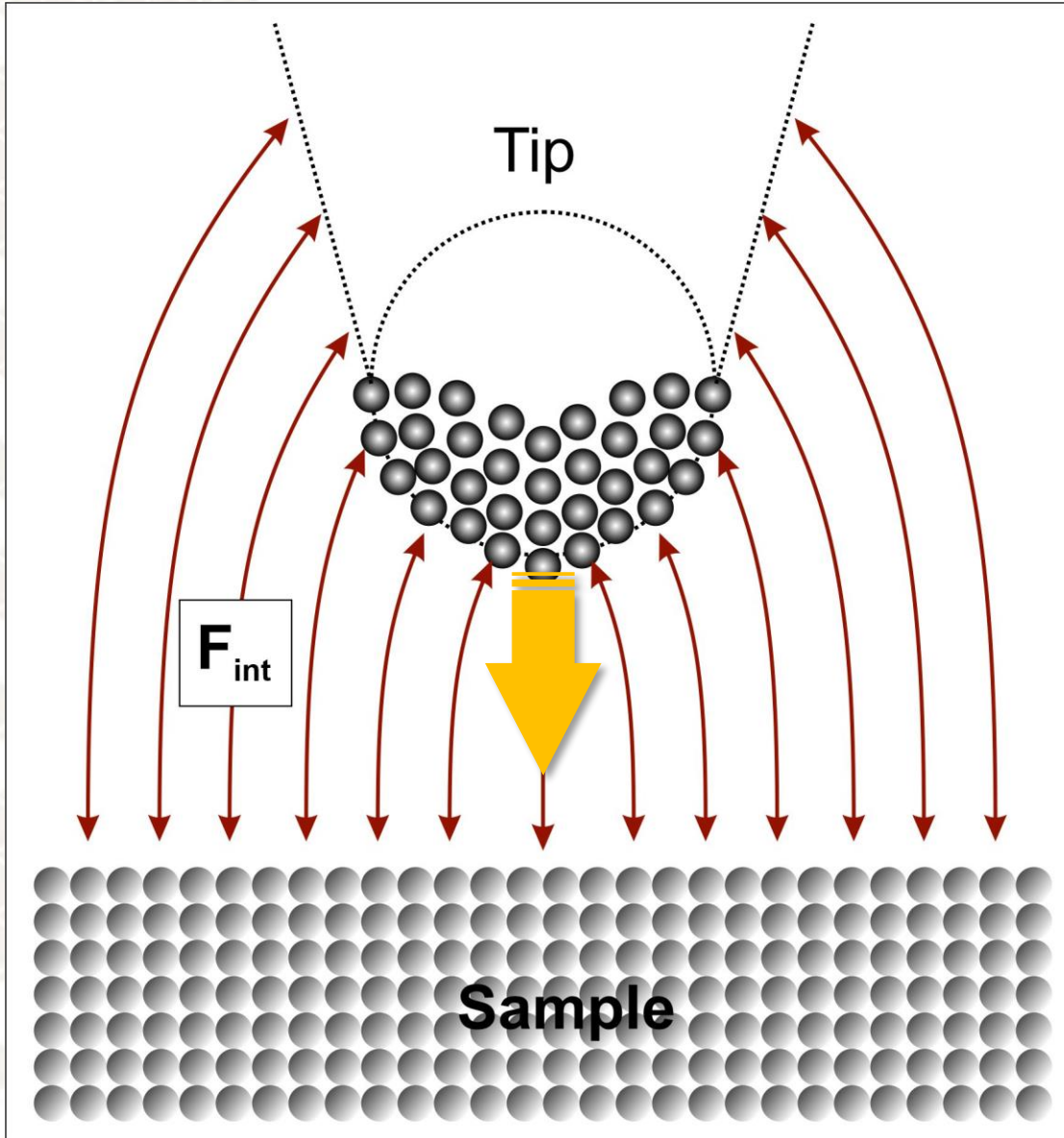

- **VdW forces** are **attractive** forces and arise between face to face surfaces in the nm range and beyond

C2- Tip-surface interaction forces

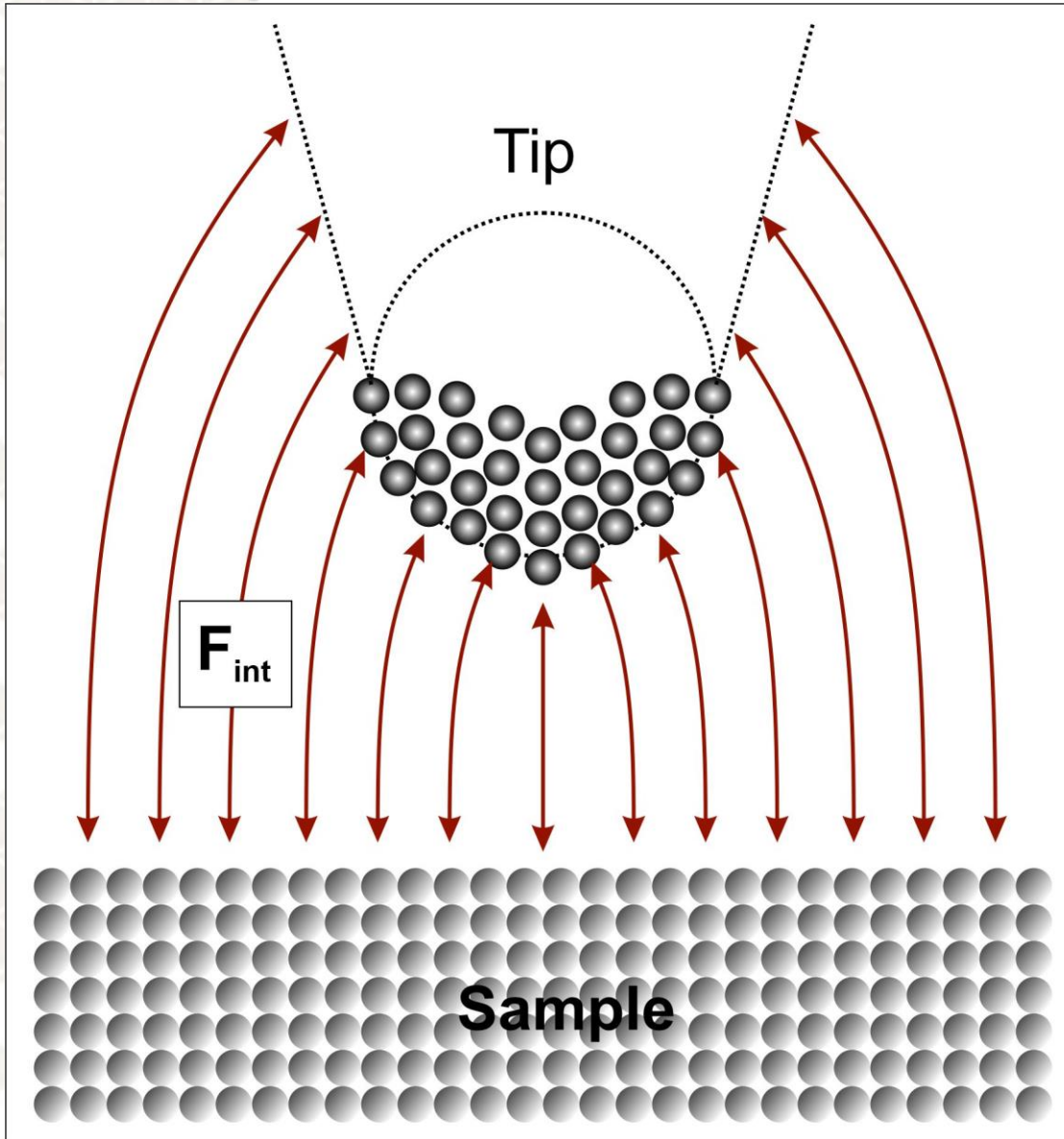

- **VdW forces** are **attractive** forces and arise between face to face surfaces in the nm range and beyond
- They stem from permanent (Debye, Keesom), and/or fluctuating (London = dispersive term), atomic dipoles
- They are universal (always occur, any type of atom)
- They result from collective effects (pairwise integration over the atoms of both surfaces), leading to the concept of Hamaker constant H of an interface
- Long-range character
- E.g. sphere (tip of radius R)/planar surface interaction force:

$$F_{\text{vdW}}(z) = -\frac{HR}{6z^2} \quad (\text{Equ.02})$$



C2- Tip-surface interaction forces

- **The micro-lever deflection** is induced by **tip-surface interatomic forces**:
 - Orders of magnitude:
 - ✓ Strength: 1 pN..10 nN
 - ✓ Distances: 1 Å .. 10 nm
 - Derive from conservative interaction potentials
 - Nature:
 - ✓ *Van der Waals* (London, Debye, Keesom) : attractive, long-range (> 1 nm, classical description)
 - ✓ **Electrostatic** (due to charges or dipoles) : attractive/repulsive, long-range/short-range, but primarily attractive & long-range by capacitive influence (> 10 nm, classical description)
 - ✓ **Chemical** (interatomic) : attractive/repulsive, short-range (~ Å, classical / quantum description)
 - ✓ **Magnetic** : attractive/repulsive, long-range (> 10 nm, classic description)

C2- Tip-surface interaction forces

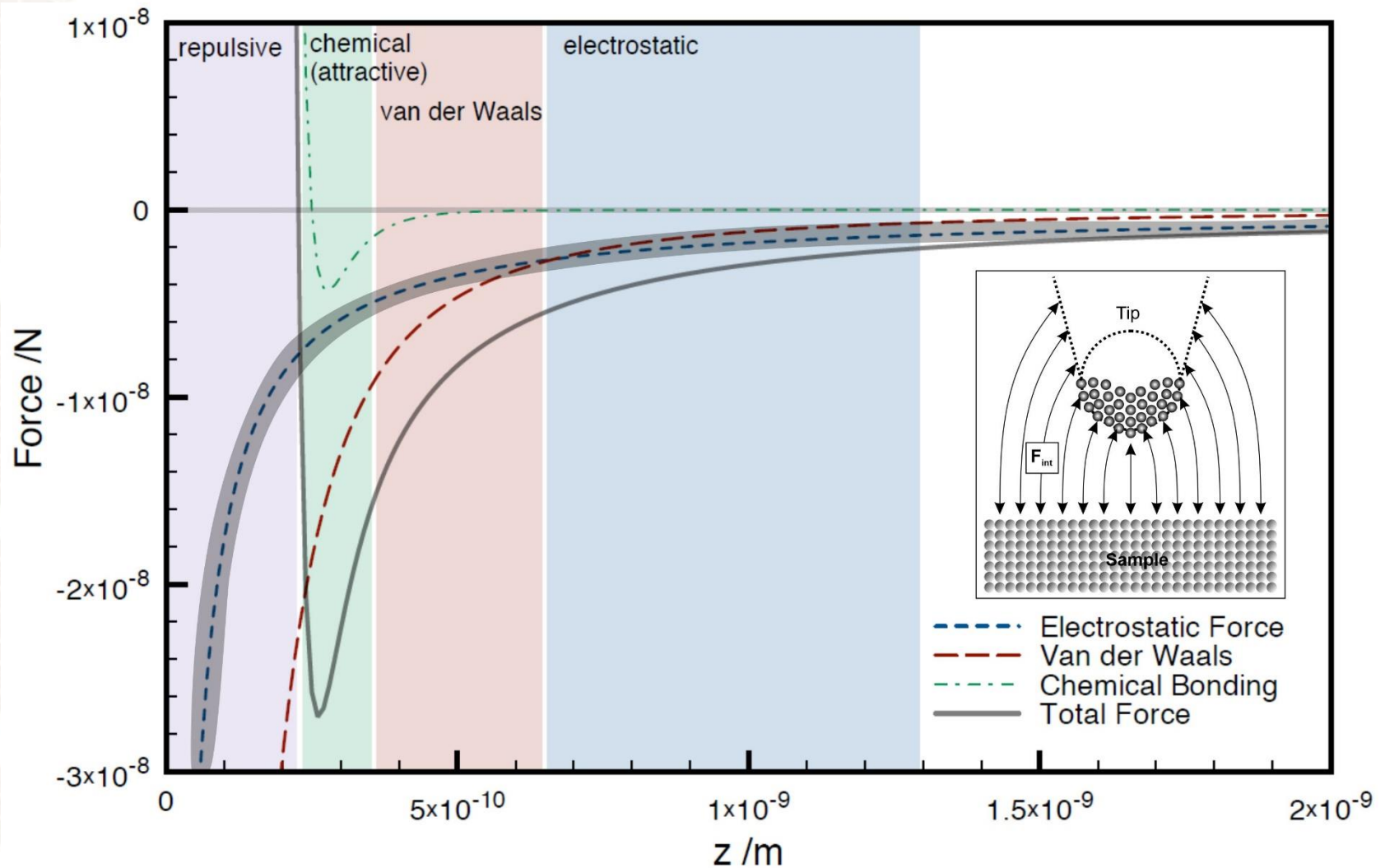

C2- Tip-surface interaction forces

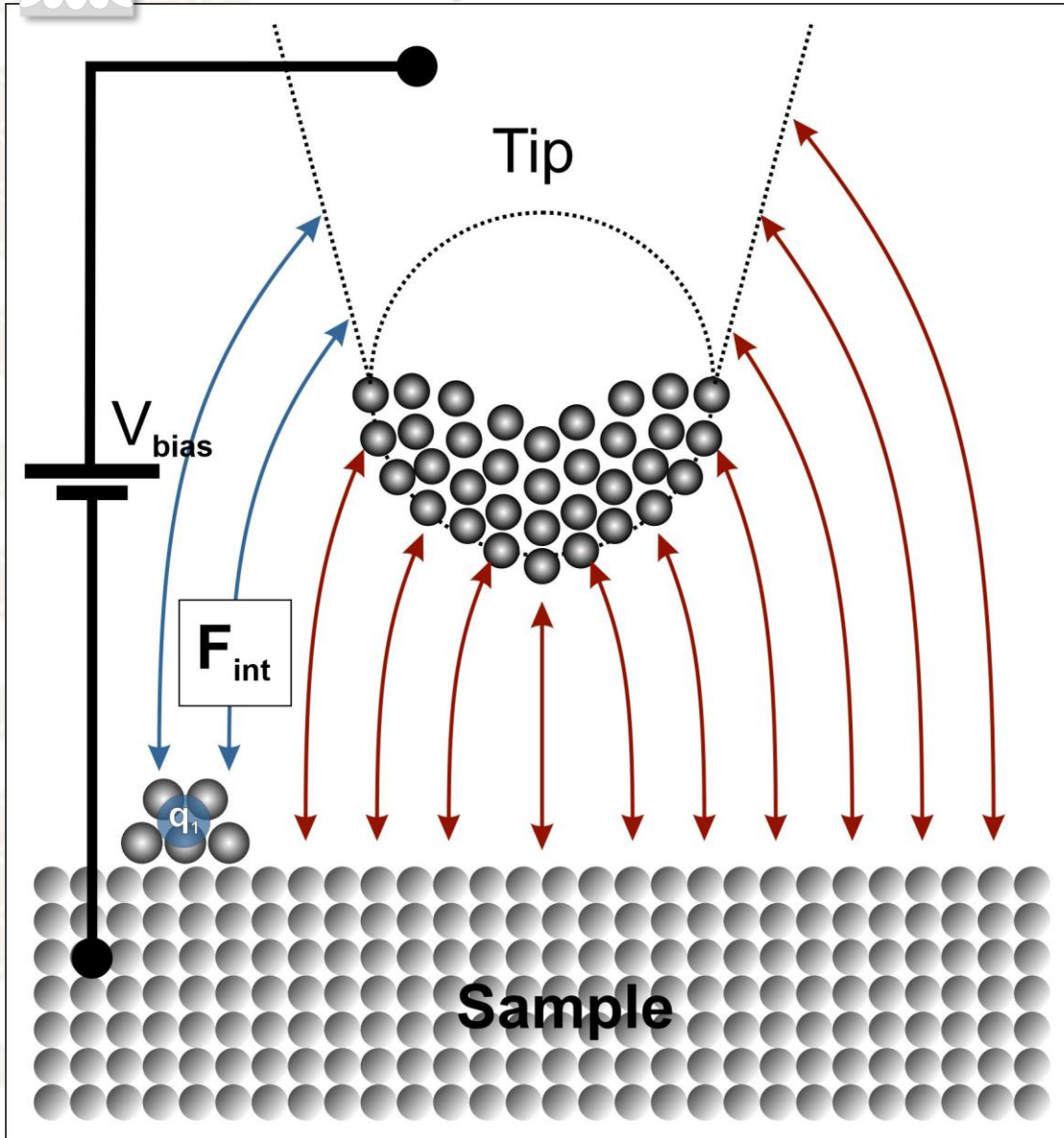

- Electrostatic forces are **mostly attractive** forces and arise between charged objects / surfaces in the nm range and beyond
- They stem from local charges (atomic adsorbates,)

C2- Tip-surface interaction forces

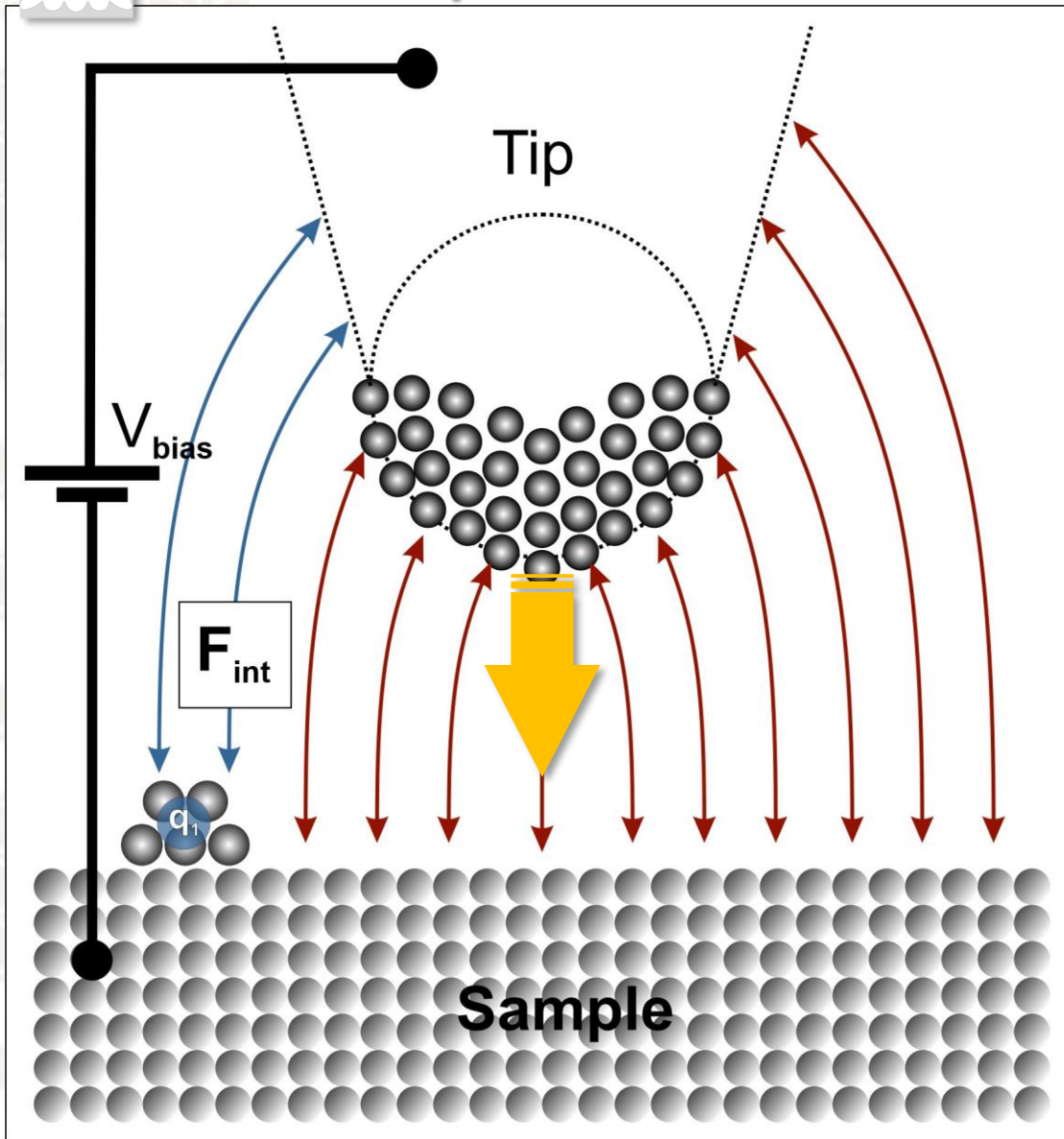

- Electrostatic forces are **mostly attractive** forces and arise between charged objects / surfaces in the nm range and beyond
- They stem from local charges (atomic adsorbates,)

C2- Tip-surface interaction forces

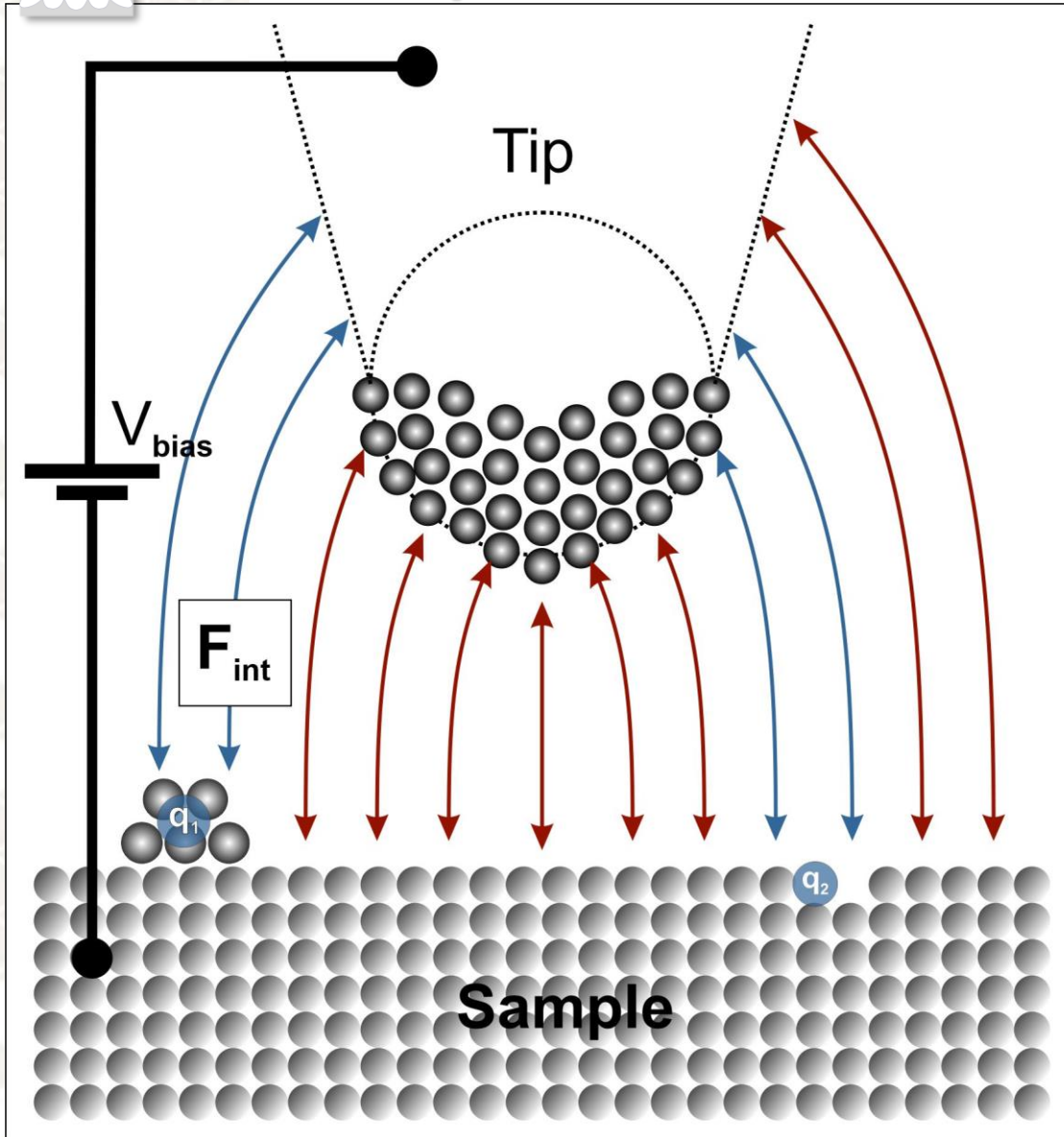

- Electrostatic forces are **mostly attractive** forces and arise between charged objects / surfaces in the nm range and beyond
- They stem from local charges (atomic adsorbates, defects)

C2- Tip-surface interaction forces

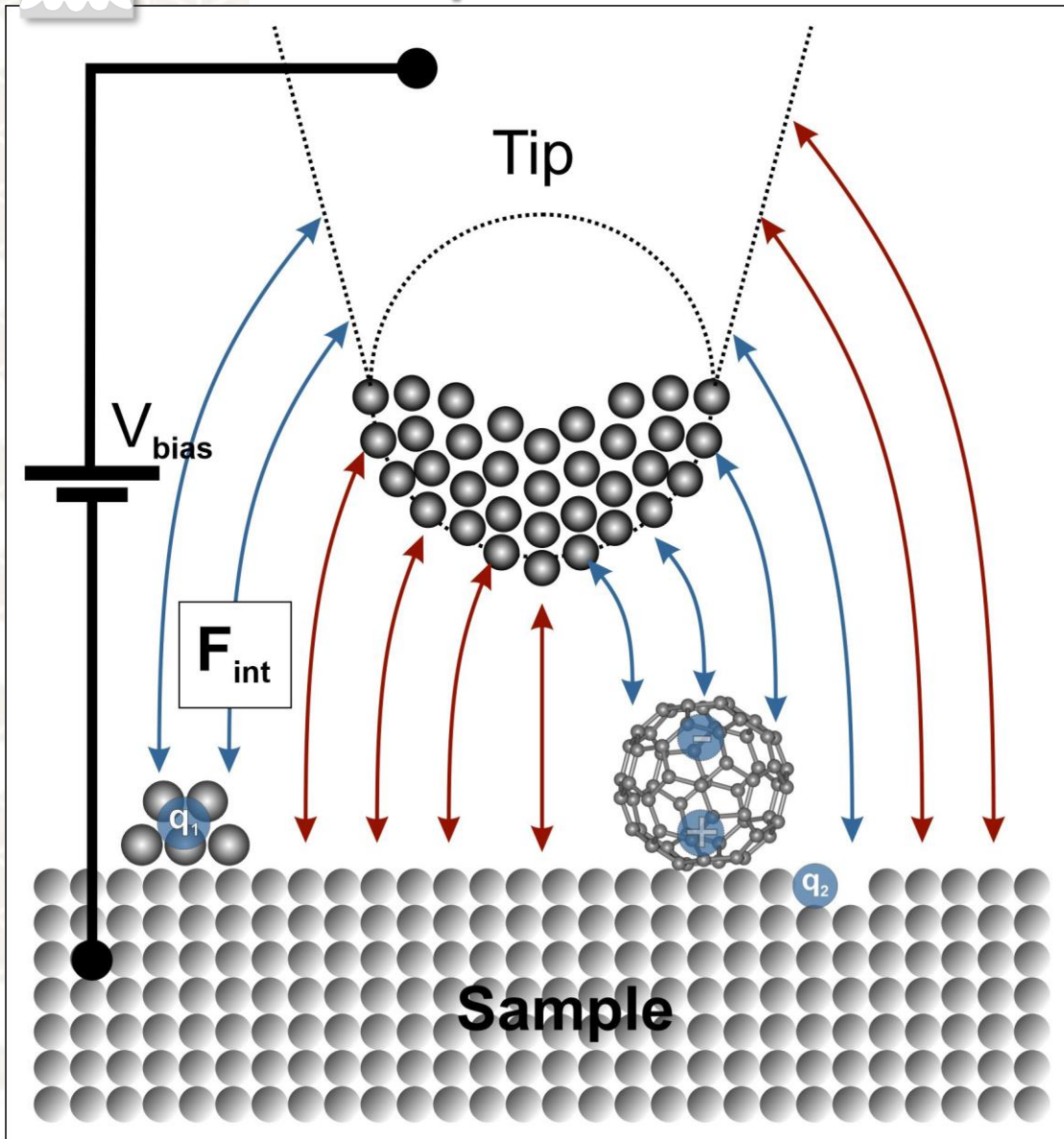

- Electrostatic forces are **mostly attractive** forces and arise between charged objects / surfaces in the nm range and beyond
- They stem from local charges (atomic adsorbates, defects) and/or dipoles (heteroatoms, molecules) and are tuned by the bias voltage applied in the interface

C2- Tip-surface interaction forces

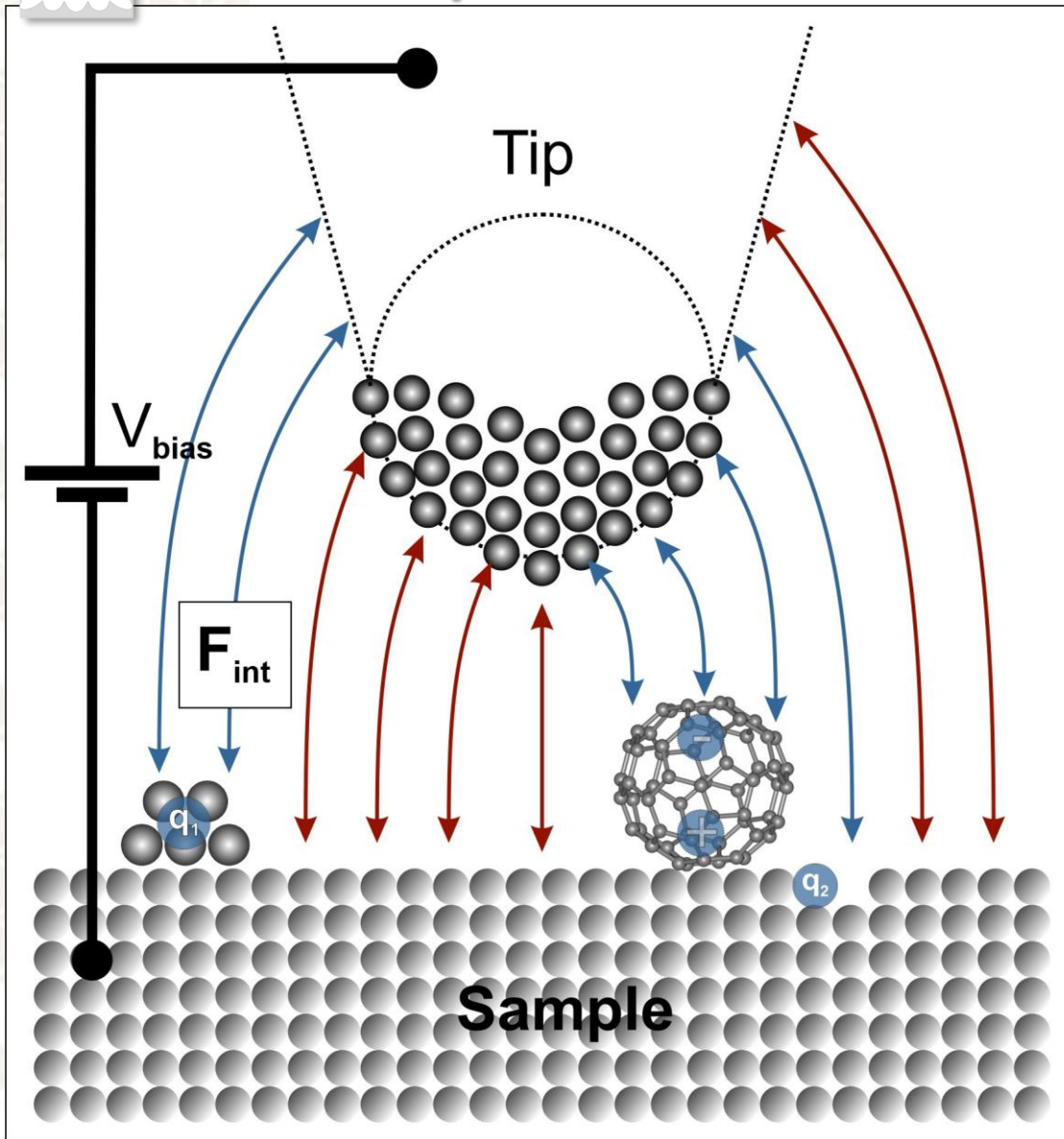

- Electrostatic forces are **mostly attractive** forces and arise between charged objects / surfaces in the nm range and beyond
- They stem from local charges (atomic adsorbates, defects) and/or dipoles (heteroatoms, molecules) and are tuned by the bias voltage applied in the interface
- They influence the interface by inducing image charges in the tip and the surface yielding capacitive forces as well as additional components that are accounted for in the framework of electrostatic multipolar analysis
- Mostly long-range character, but may also exhibit short-range effects
- Require fine modelization



Reference / review papers & books

- “Polarization effects in noncontact atomic force microscopy: A key to model the tip-sample interaction above charged adatoms”

F. Bocquet *et al.*, Phys. Rev. B **83**, 035411 (2011)

- “Multiscale approach for simulations of Kelvin probe force microscopy with atomic resolution”

A. Sadeghi *et al.*, Phys. Rev. B **86**, 075407 (2012)

- “The weight function for charges—A rigorous theoretical concept for Kelvin probe force microscopy”

H. Söngen *et al.*, J. Appl. Phys. **119**, 025304 (2016)

C2- Tip-surface interaction forces

- **The micro-lever deflection** is induced by **tip-surface interatomic forces**:
 - Orders of magnitude:
 - ✓ Strength: 1 pN..10 nN
 - ✓ Distances: 1 Å .. 10 nm
 - Derive from conservative interaction potentials
 - Nature:
 - ✓ *Van der Waals* (London, Debye, Keesom) : attractive, long-range (> 1 nm, classical description)
 - ✓ *Electrostatic* (due to charges or dipoles) : attractive/repulsive, long-range/short-range, but primarily attractive & long-range by capacitive influence (> 10 nm, classical description)
 - ✓ **Chemical** (interatomic) : attractive/repulsive, short-range (~ Å, classical / quantum description)
 - ✓ *Magnetic* : attractive/repulsive, long-range (> 10 nm, classic description)

C2- Tip-surface interaction forces

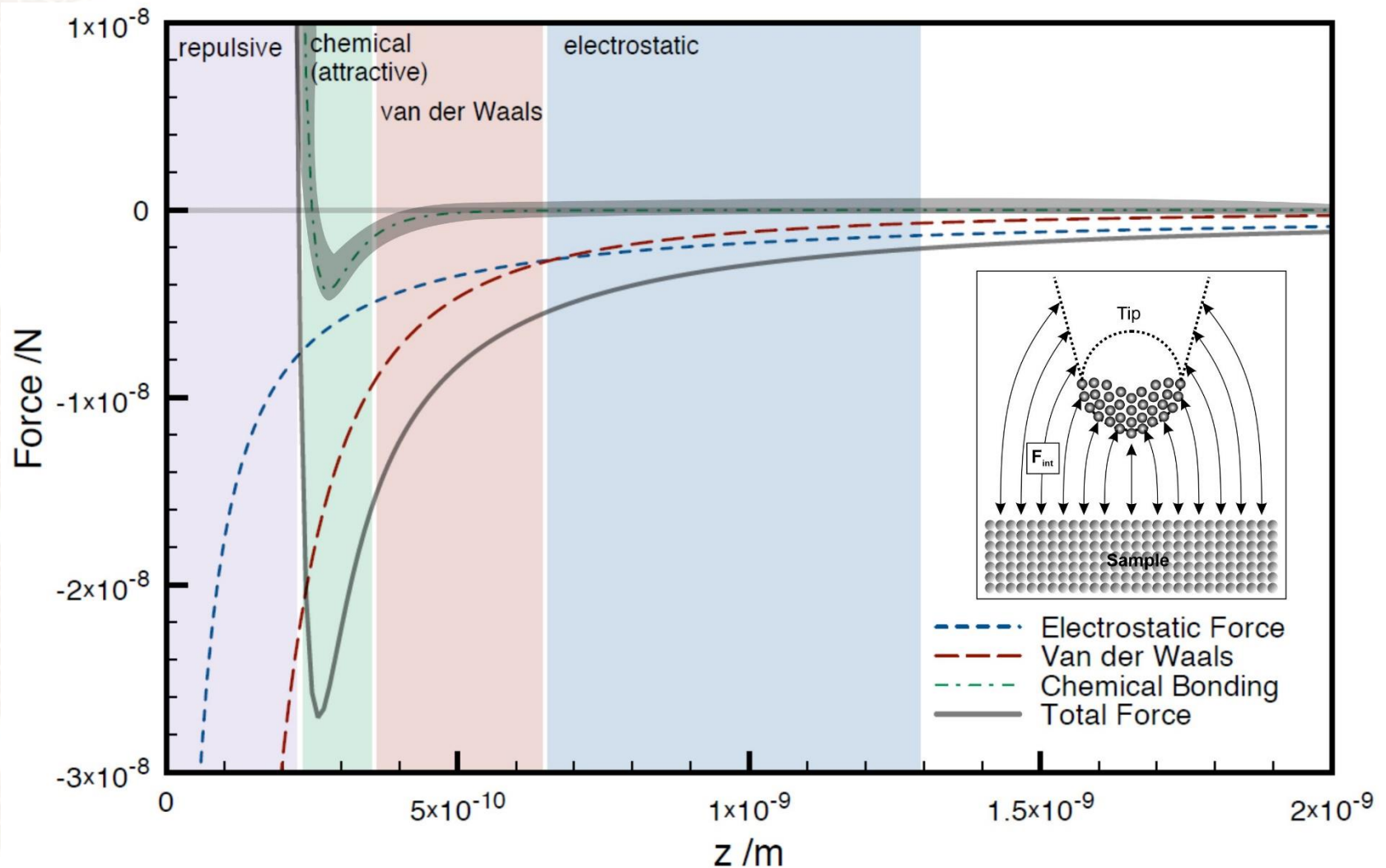

C2- Tip-surface interaction forces

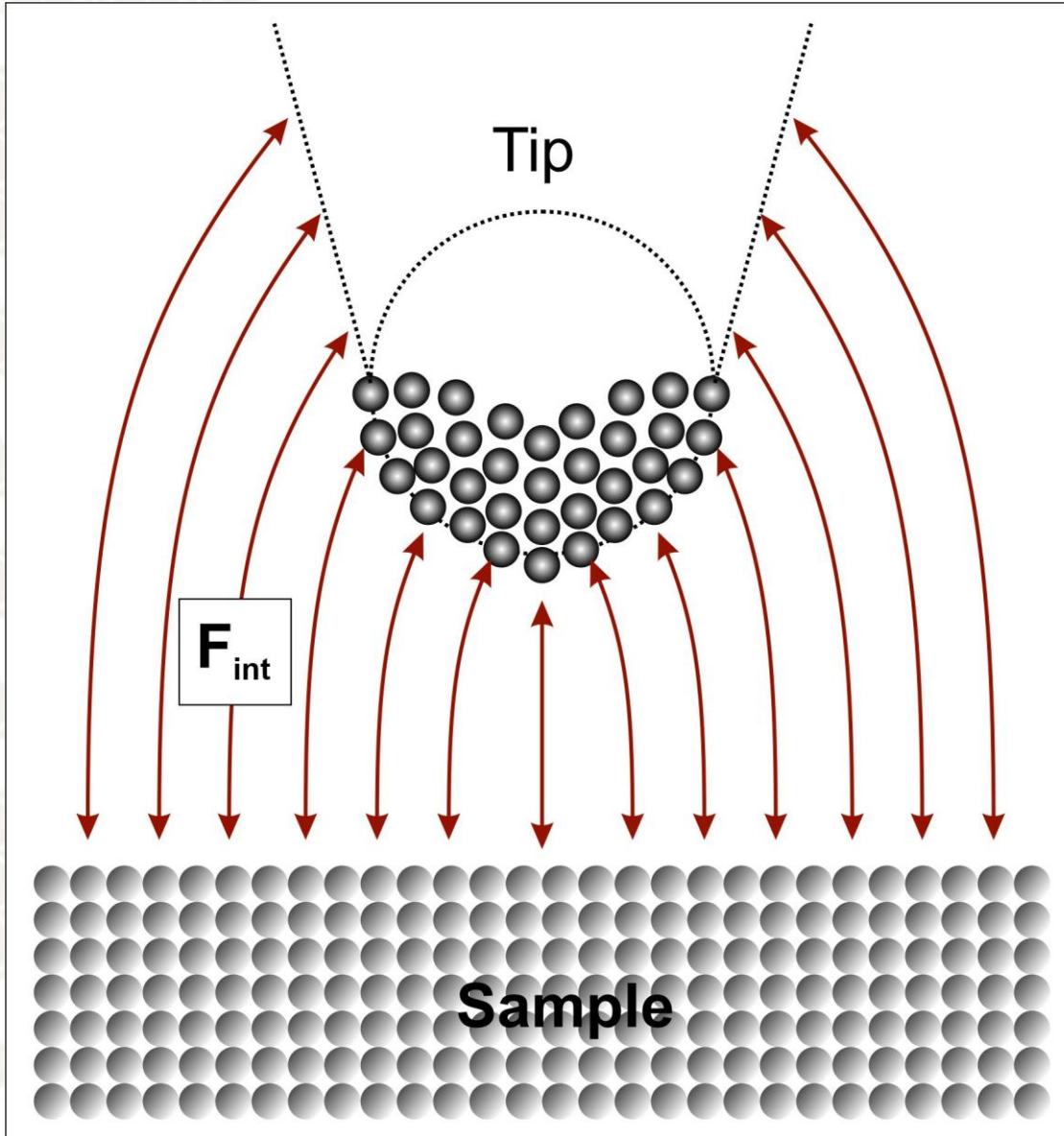

- Chemical interatomic forces start prevailing few Å above the surface

C2- Tip-surface interaction forces

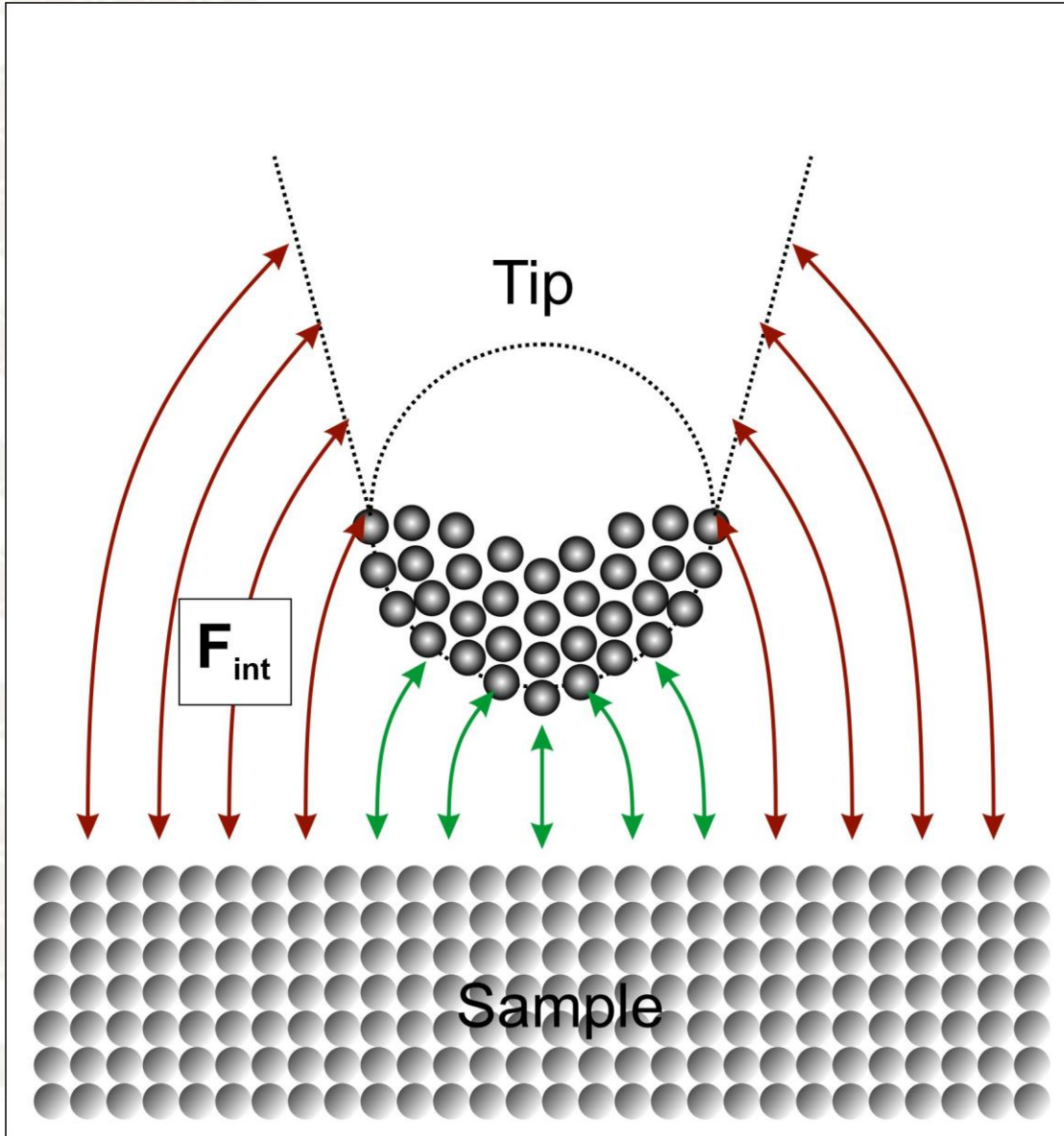

- Chemical interatomic forces start prevailing few Å above the surface
- They derive from interatomic interaction potentials (Morse, Lennard-Jones) with a short-range character

C2- Tip-surface interaction forces

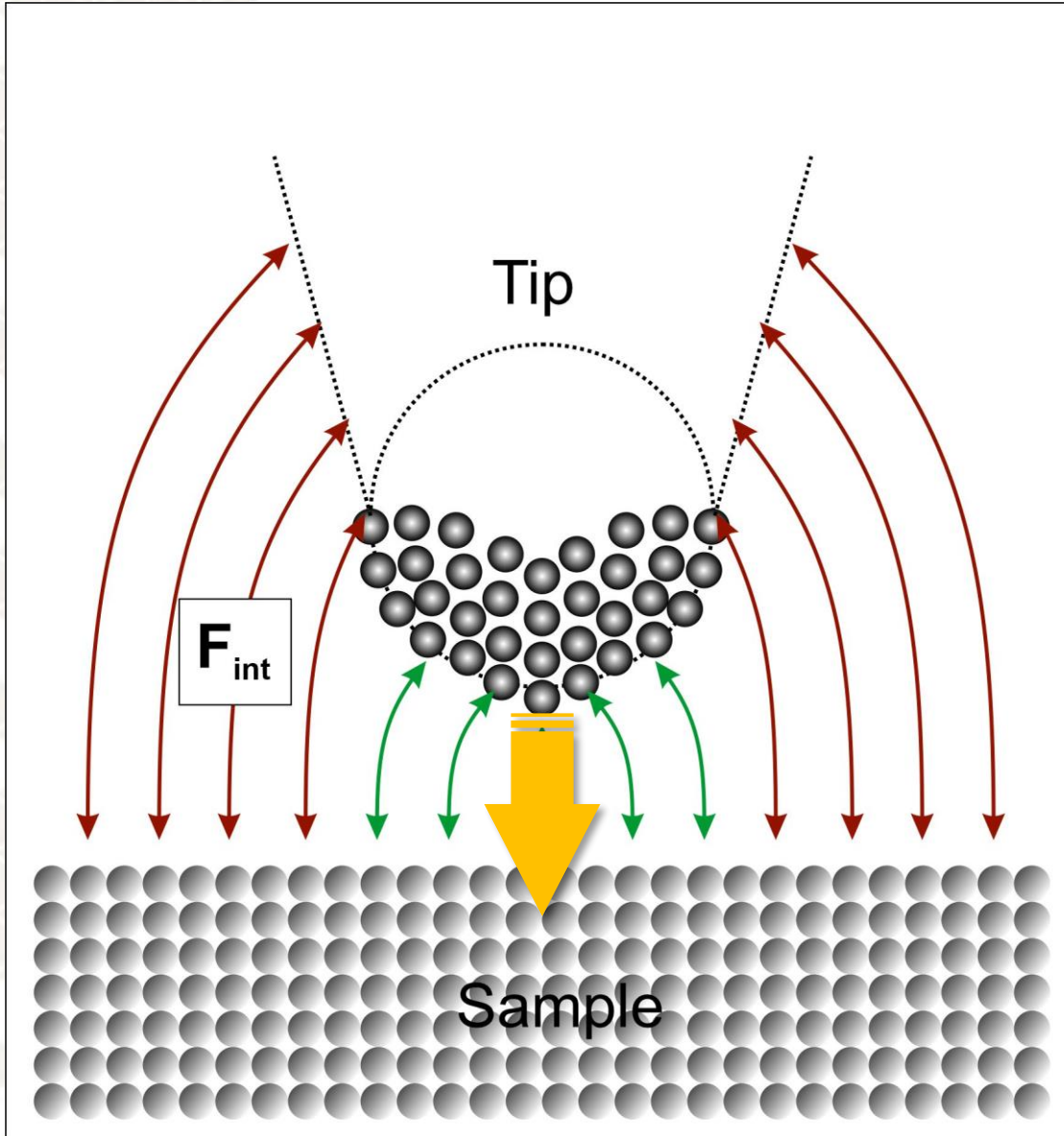

- Chemical interatomic forces start prevailing few Å above the surface
- They derive from interatomic interaction potentials (Morse, Lennard-Jones) with a short-range character
- They are **attractive**
- E.g. Morse interaction:

$$F_{\text{Morse}}(z) = -U_0 \frac{\partial}{\partial z} \left(e^{-(z-r_c)/\lambda} \right)$$

C2- Tip-surface interaction forces

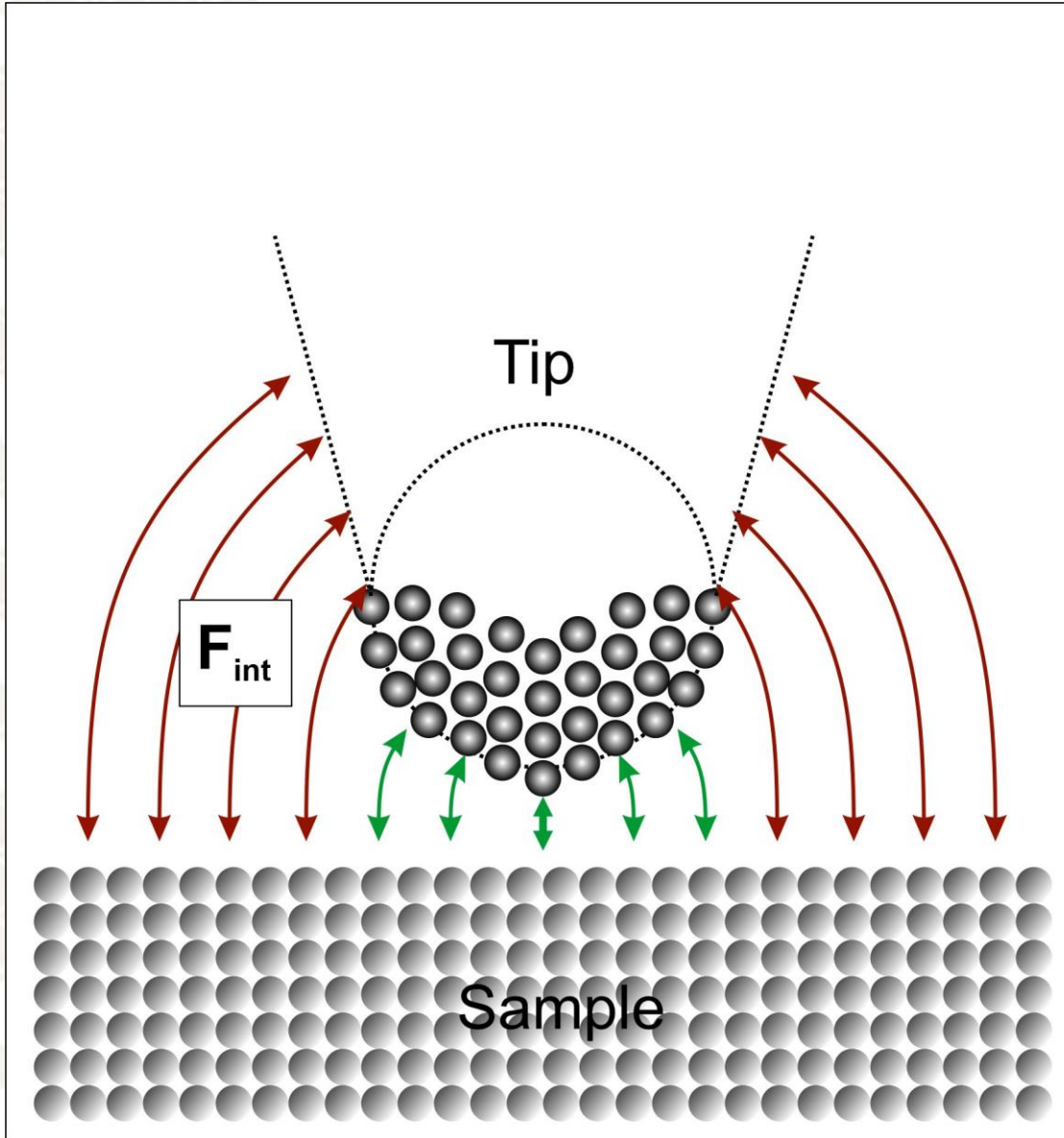

- Chemical interatomic forces start prevailing few Å above the surface
- They derive from interatomic interaction potentials (Morse, Lennard-Jones) with a short-range character
- They are **attractive** & **repulsive** (Pauli repulsion)
- E.g. Morse interaction:

$$F_{\text{Morse}}(z) = -U_0 \frac{\partial}{\partial z} \left(e^{-(z-r_c)/\lambda} \right)$$

(Equ.03)

C2- Tip-surface interaction forces

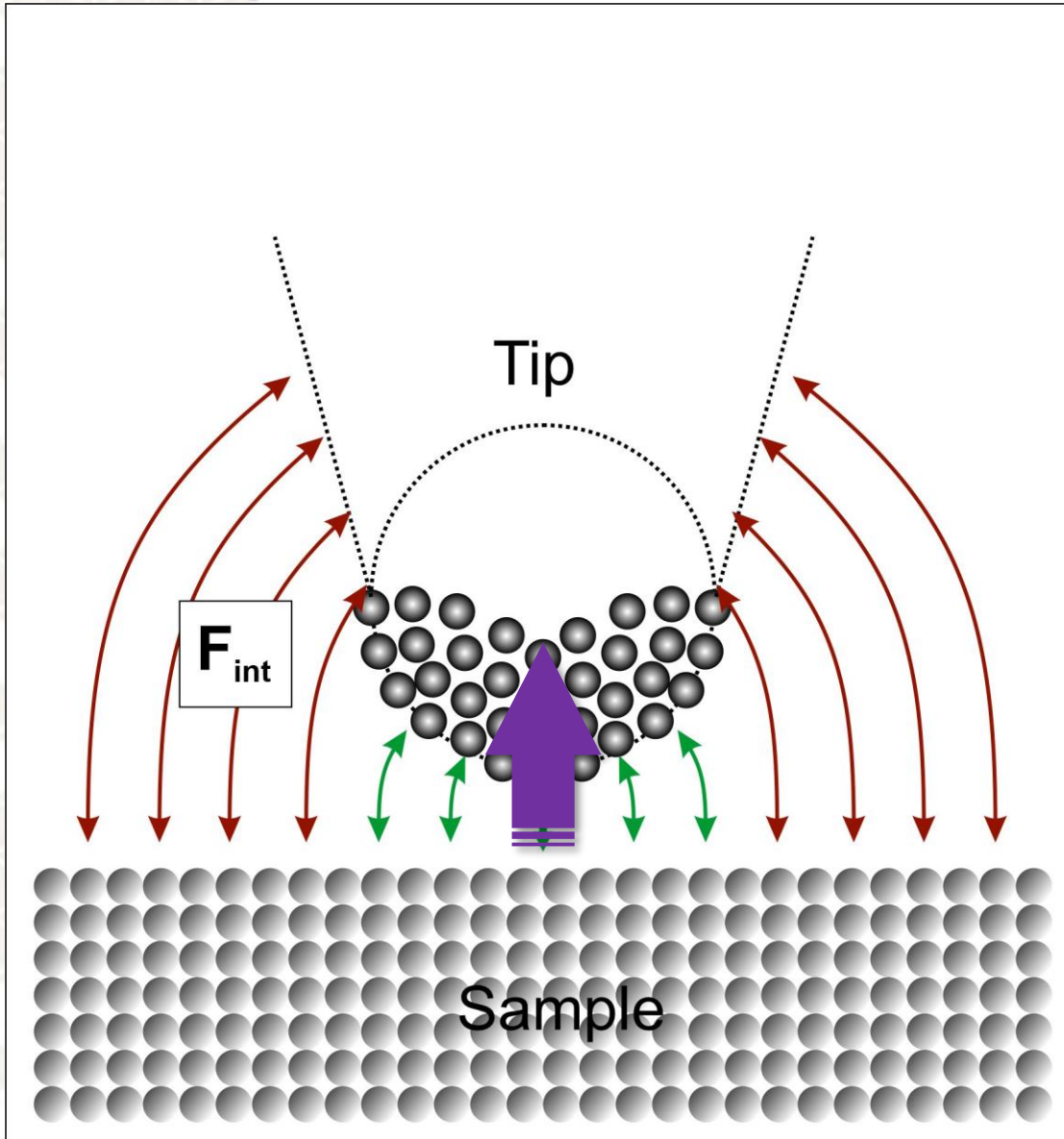

- Chemical interatomic forces start prevailing few Å above the surface
- They derive from interatomic interaction potentials (Morse, Lennard-Jones) with a short-range character
- They are **attractive** & **repulsive** (Pauli repulsion)
- E.g. Morse interaction:

$$F_{\text{Morse}}(z) = -U_0 \frac{\partial}{\partial z} \left(e^{-(z-r_c)/\lambda} - e^{-2(z-r_c)/\lambda} \right)$$

(Equ.03)

C2- Tip-surface interaction forces

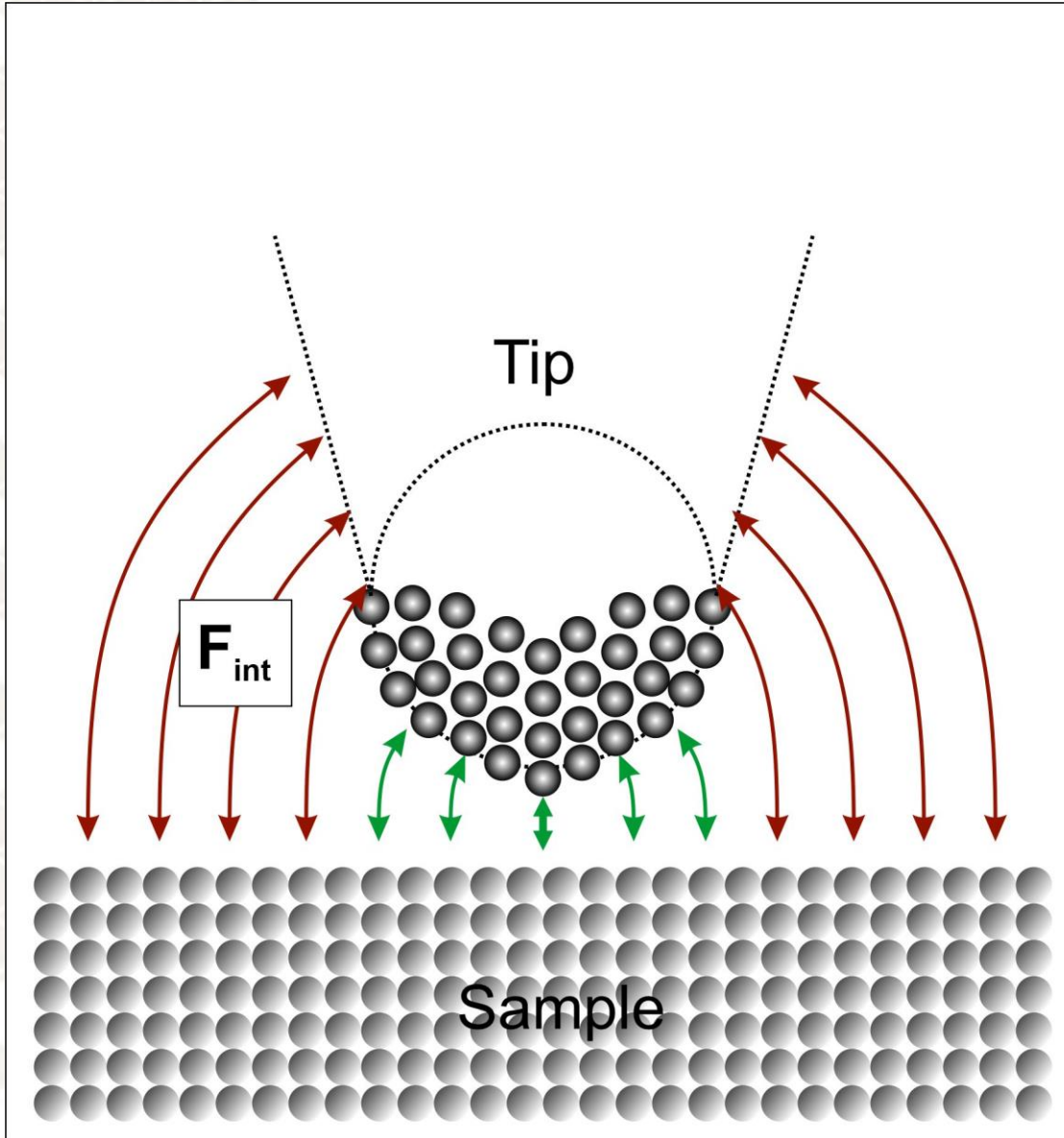

- Chemical interatomic forces start prevailing few Å above the surface
- They derive from interatomic interaction potentials (Morse, Lennard-Jones) with a short-range character
- They are **attractive** & **repulsive** (Pauli repulsion)
- E.g. Morse interaction:

$$F_{\text{Morse}}(z) = -U_0 \frac{\partial}{\partial z} \left(e^{-(z-r_c)/\lambda} - e^{-2(z-r_c)/\lambda} \right)$$

(Equ.03)

- Those forces are primarily responsible for the high-resolution imaging in nc-AFM!

C2- Tip-surface interaction forces

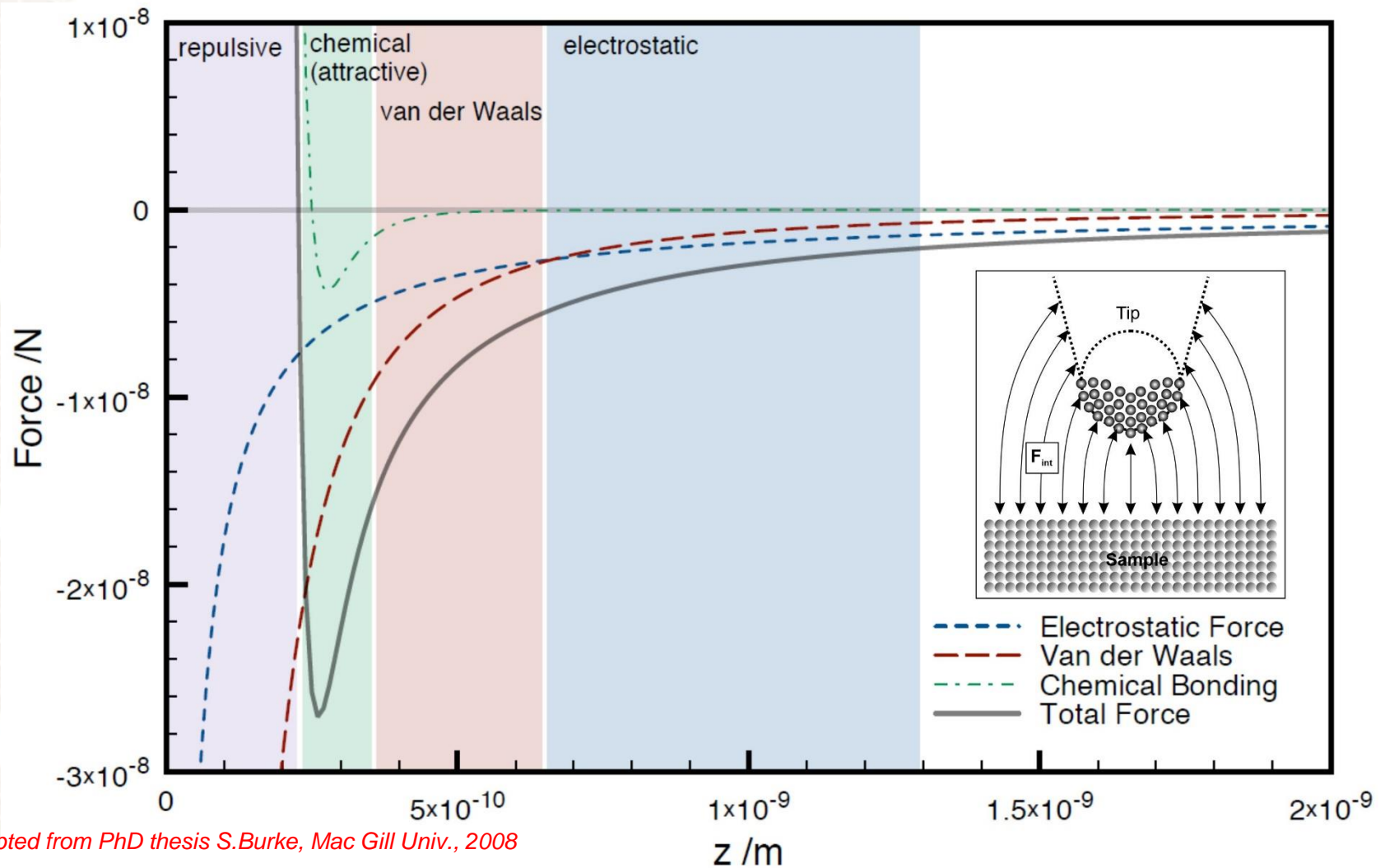

¹Adapted from PhD thesis S.Burke, Mac Gill Univ., 2008

C2- Tip-surface interaction forces

- Tip-surface interatomic forces : figuring out the scaling

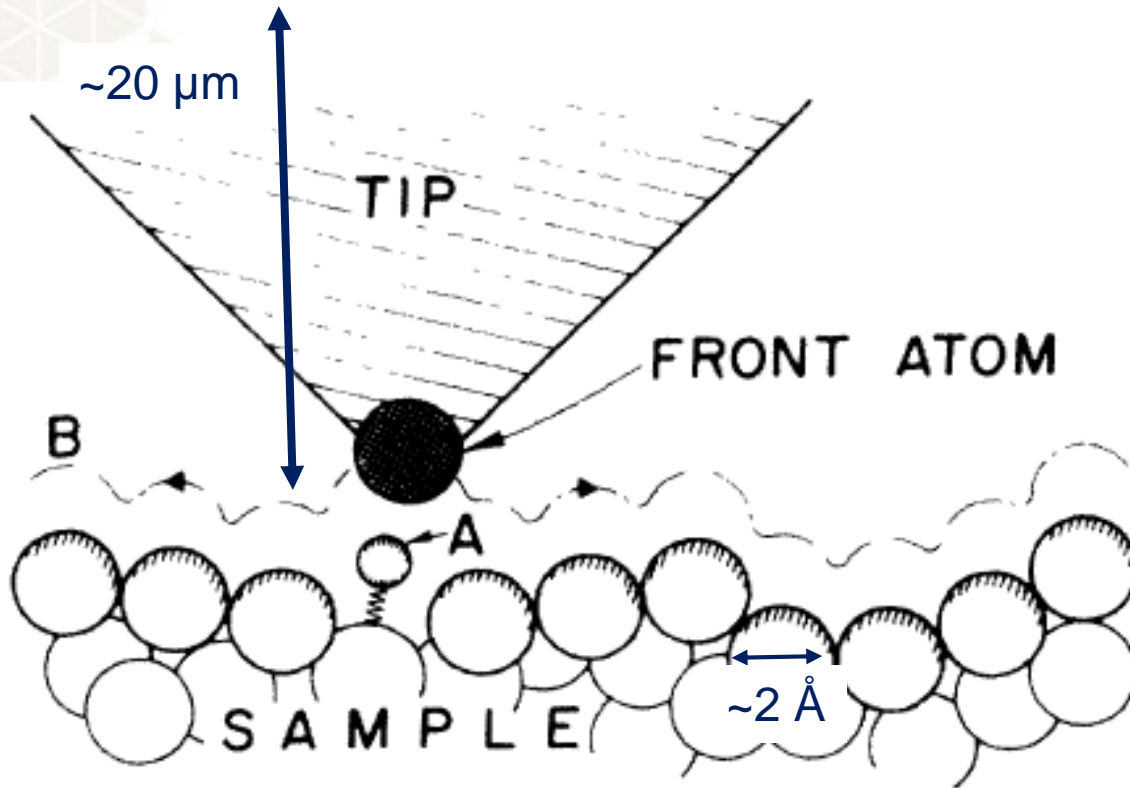

G.Binnig et al., Phys. Rev. Lett. 56, p930 (1986)

C2- Tip-surface interaction forces

- Tip-surface interatomic forces : figuring out the scaling

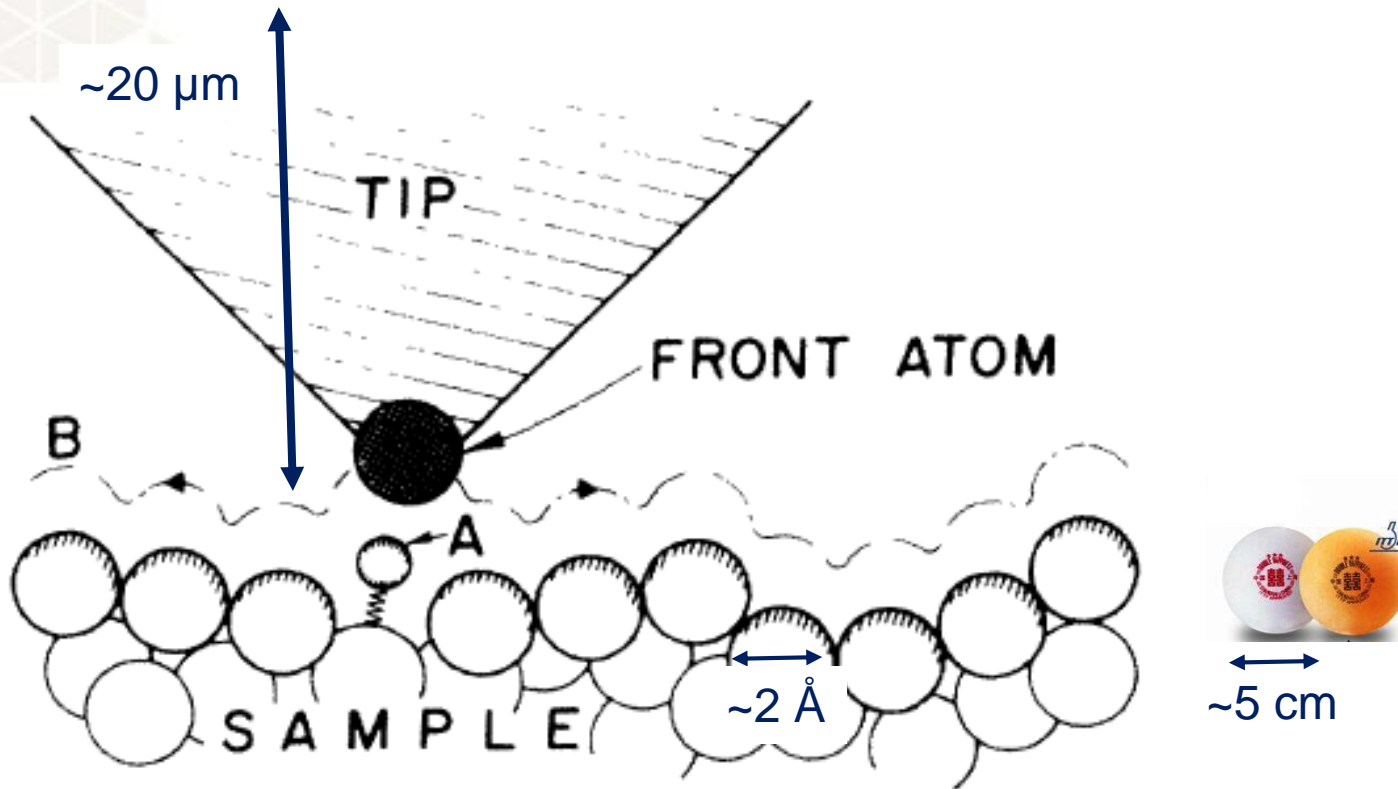

G.Binnig et al., *Phys. Rev. Lett.* **56**, p930 (1986)

C2- Tip-surface interaction forces

- Tip-surface interatomic forces : figuring out the scaling

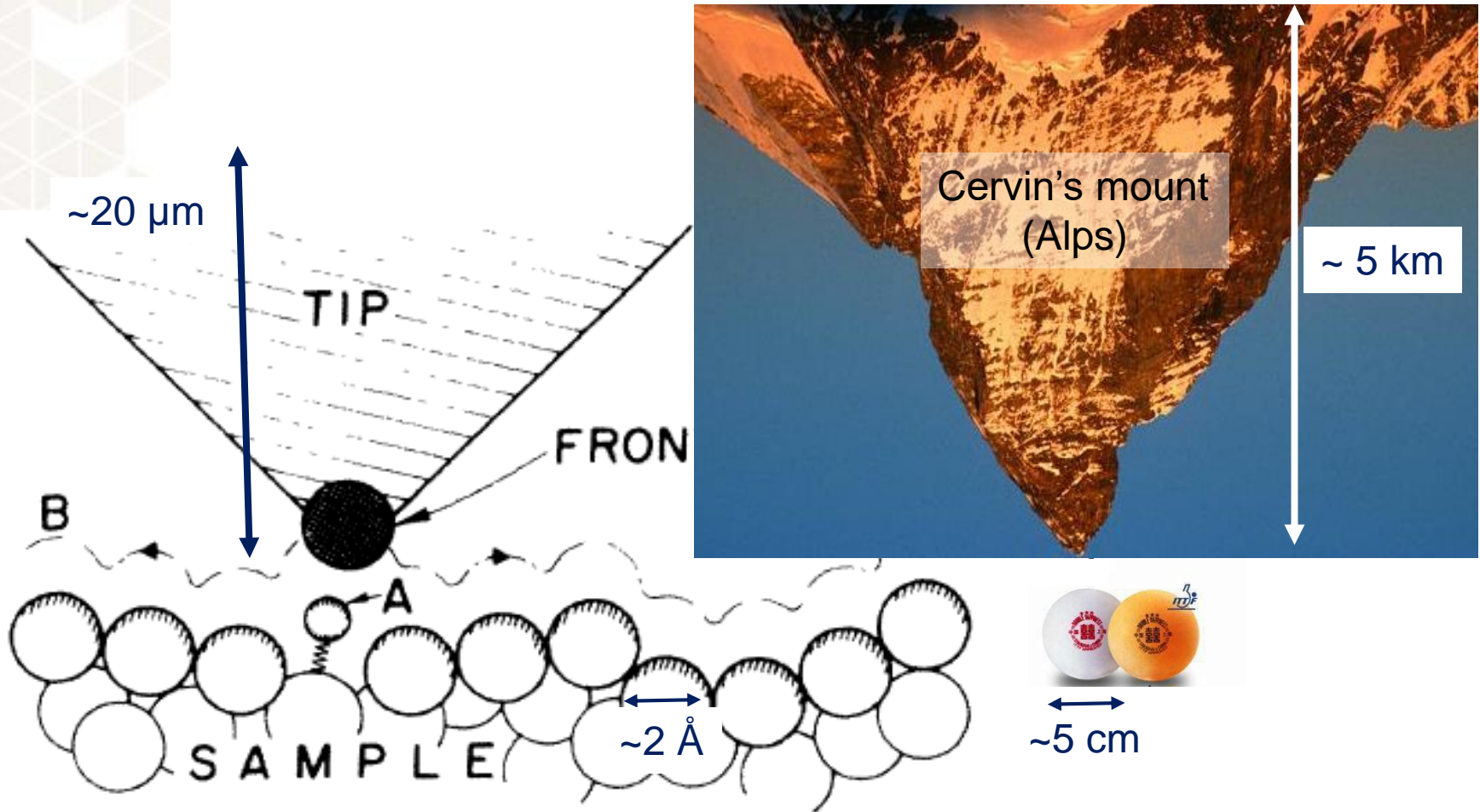

G.Binnig et al., *Phys. Rev. Lett.* **56**, p930 (1986)

C – AFM in 4 steps (contact mode concept)

1. The probe:
 - a. Cantilever
 - b. Quartz tuning fork
2. Tip-surface interaction forces
3. Detecting the tip-surface interaction force:
 - a. Cantilever
 - b. Quartz tuning fork
4. Surface scanning and feedback

C3- Detecting the interaction force: cantilever

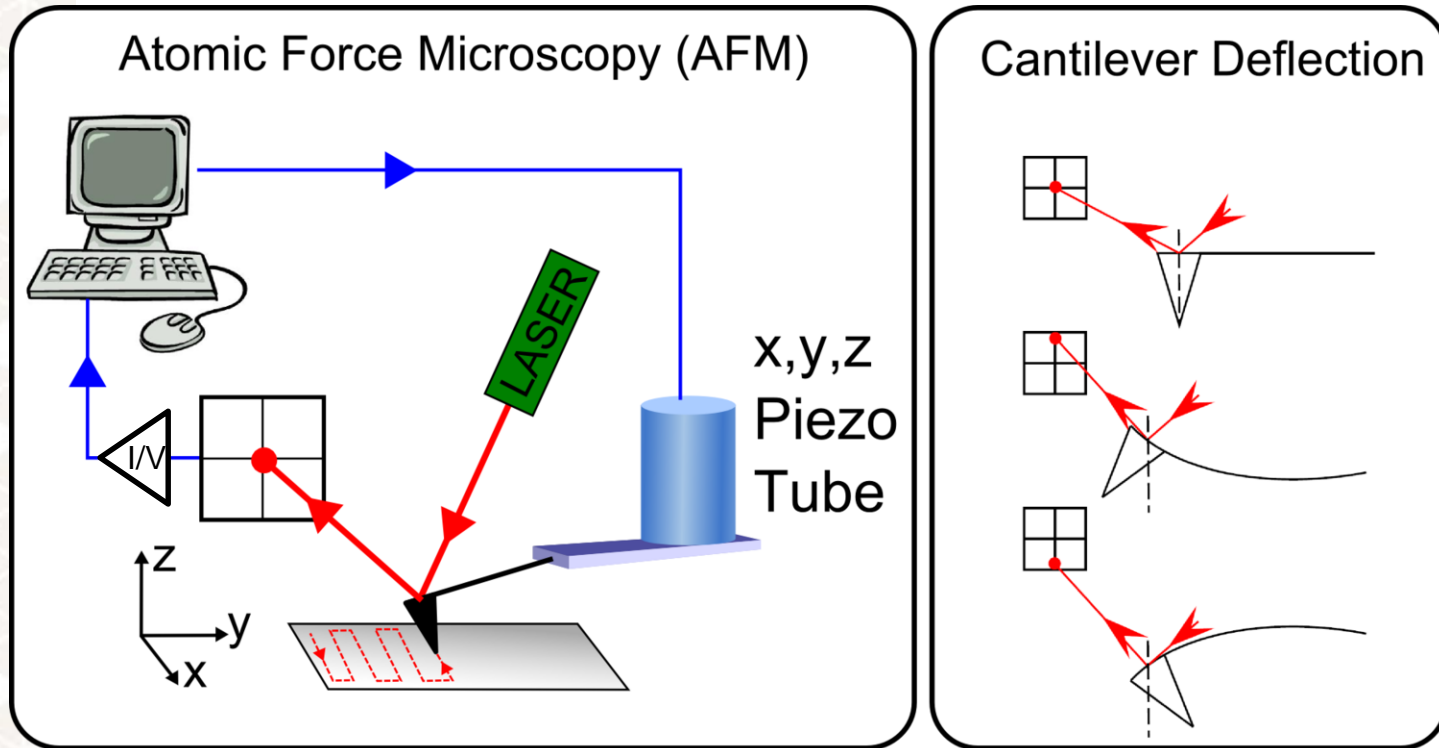



C3- Detecting the interaction force: cantilever

- 4-quadrants PhotoSensitive Detector : PSD

- 4 PN junctions side-by-side
- 4 anodes + 1 common cathode

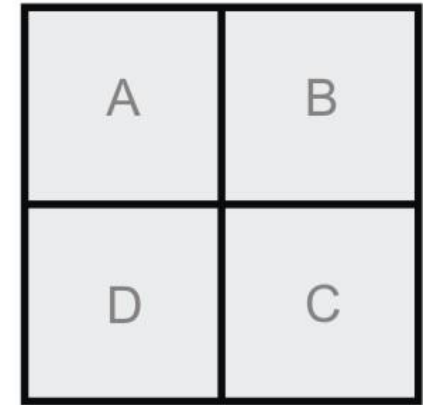
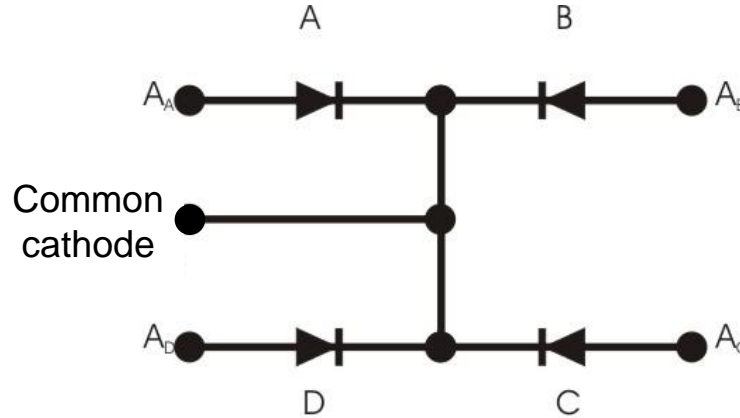

Ex.: PDB c-203 (Advanced photonix, Inc)

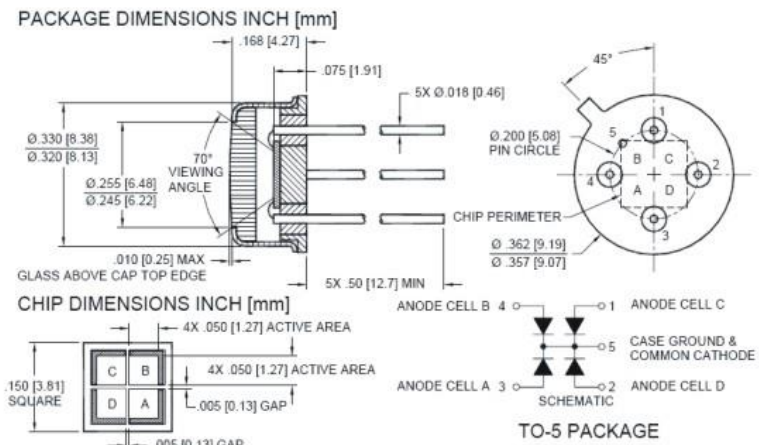



C3- Detecting the interaction force: cantilever

- 4-quadrants PhotoSensitive Detector : PSD

- 4 PN junctions side-by-side
- 4 anodes + 1 common cathode

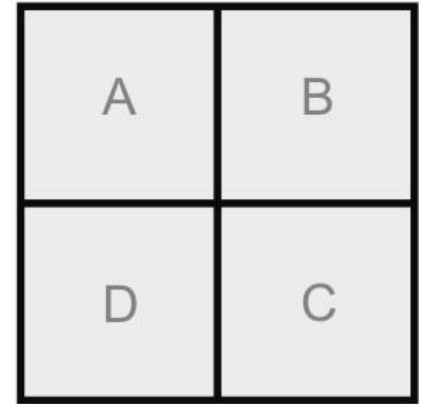
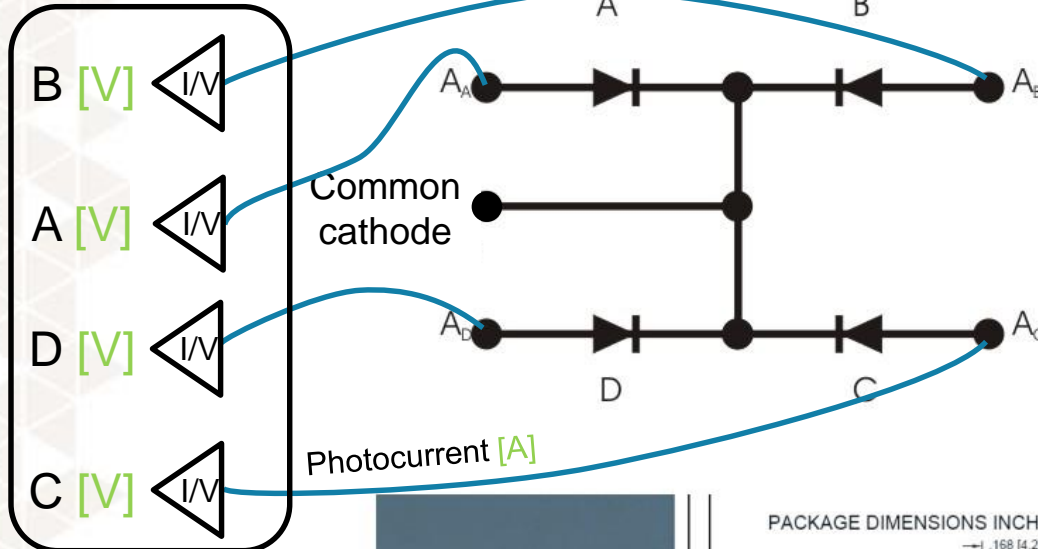

Preamplifiers



Ex.: PDB c-203 (Advanced photonix, Inc)

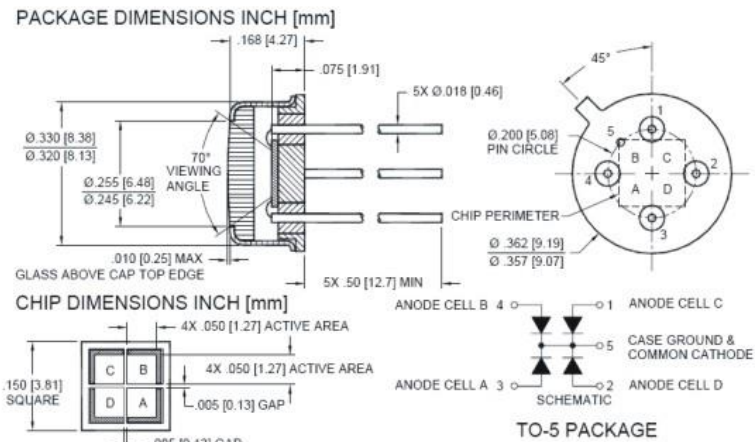



C3- Detecting the interaction force: cantilever

- Detection process :

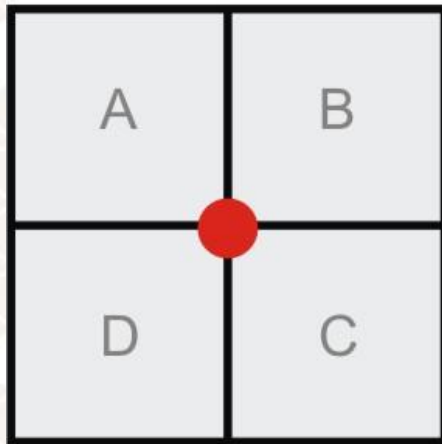

Photocurrent (/quad)

Total photocurrent

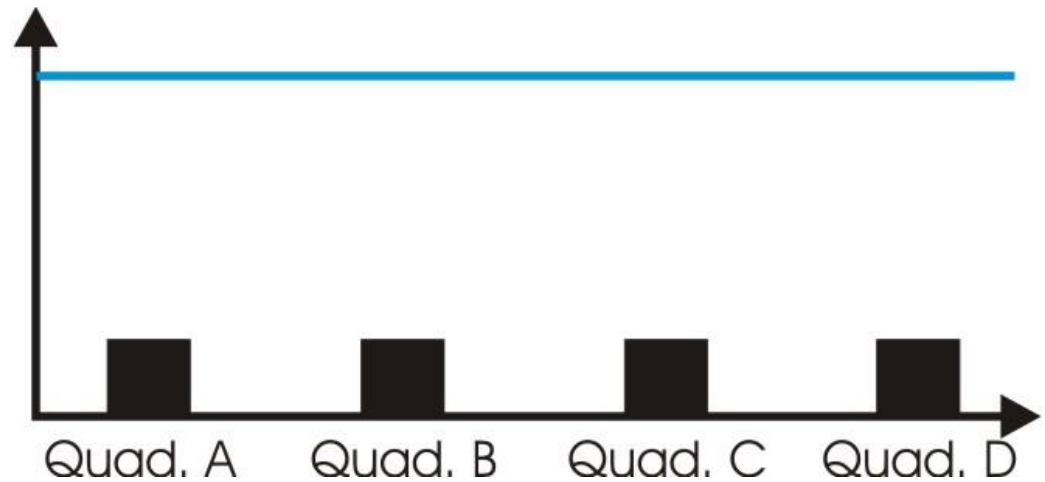



C3- Detecting the interaction force: cantilever

- Detection process :

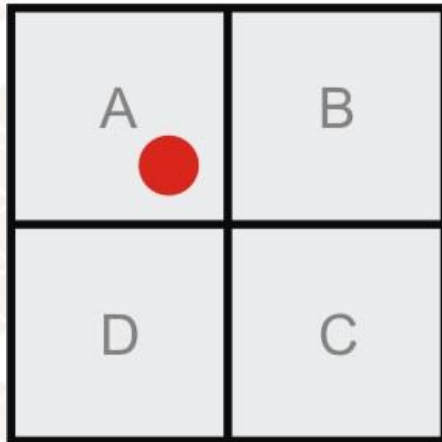

Photocurrent (/quad)

Total photocurrent

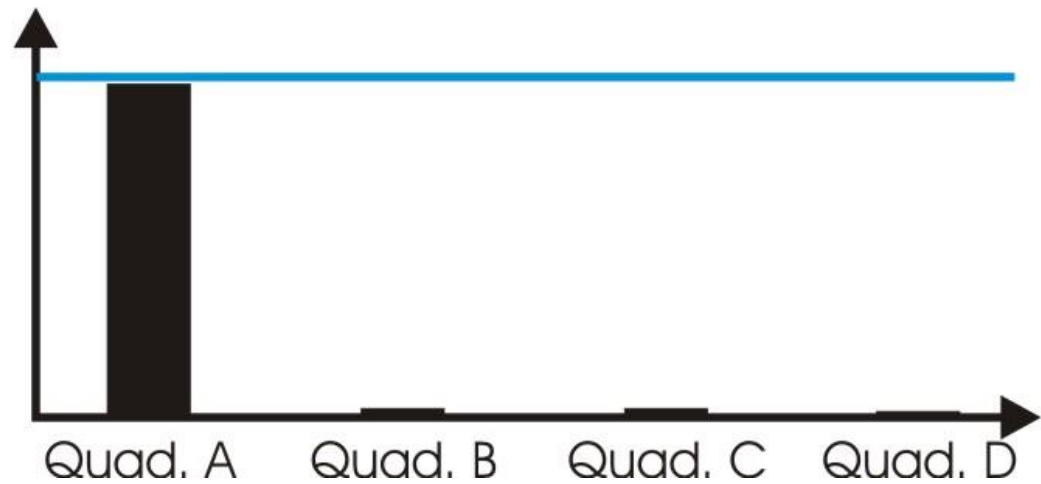



C3- Detecting the interaction force: cantilever

- Detection process :

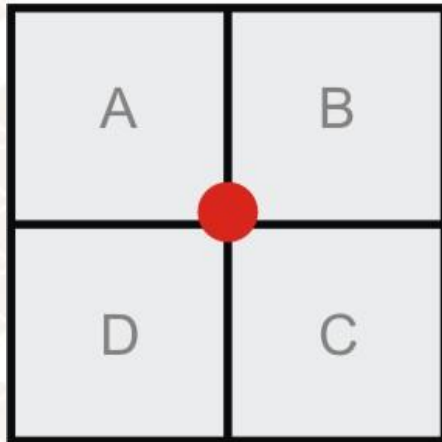

Photocurrent (/quad)

Total photocurrent

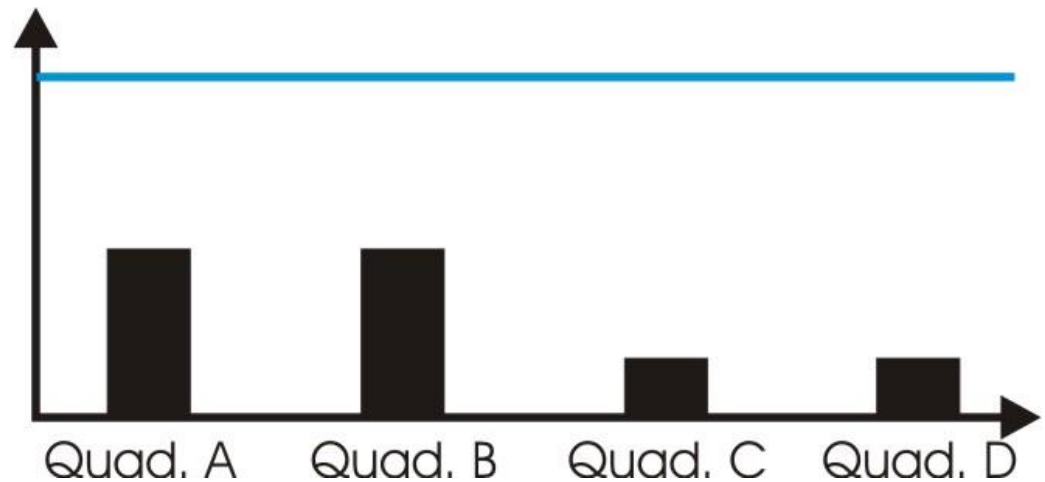



C3- Detecting the interaction force: cantilever

- Detection process :

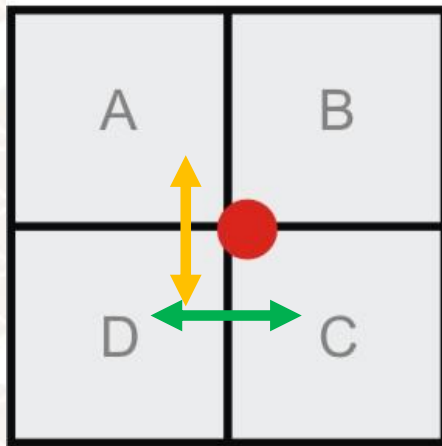

Photocurrent (/quad)

Total photocurrent

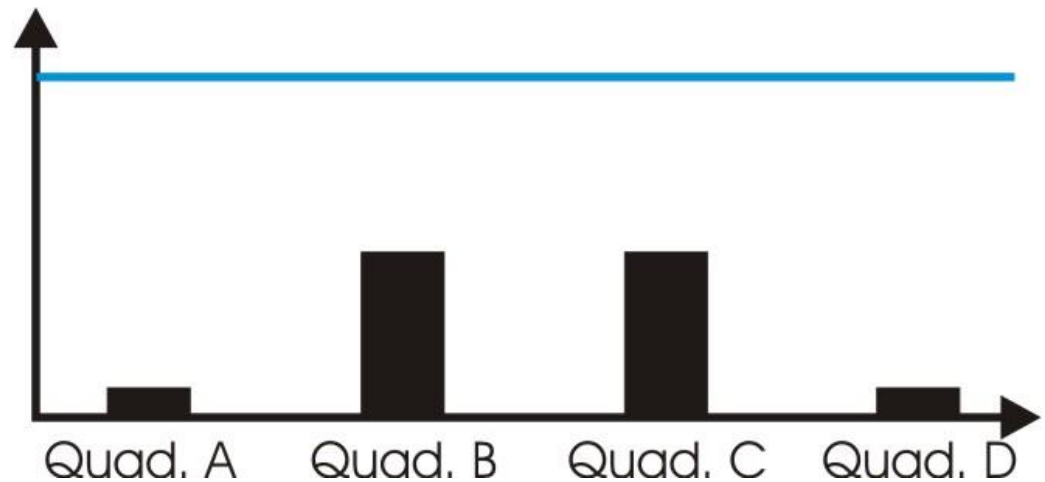

Cantilever deflection = « Normal force » = $(A + B) - (C + D)$

Cantilever torsion = « Lateral force » = $(A + D) - (B + C)$



C3- Detecting the interaction force: cantilever

- Detection process : the **deflection** & the **torsion** calculation is performed out of a further analog operationnal stage

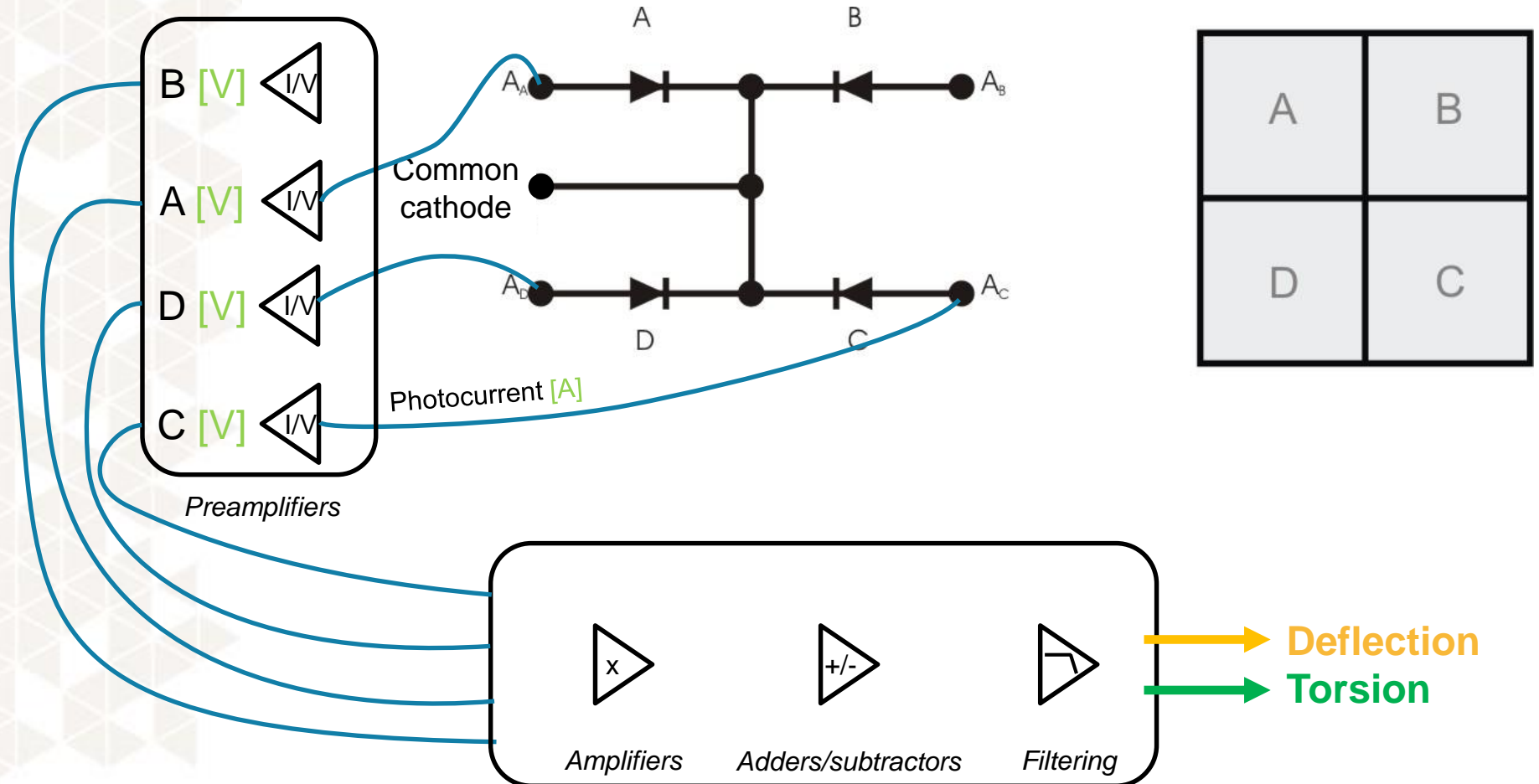

C3- Detecting the interaction force: QTF

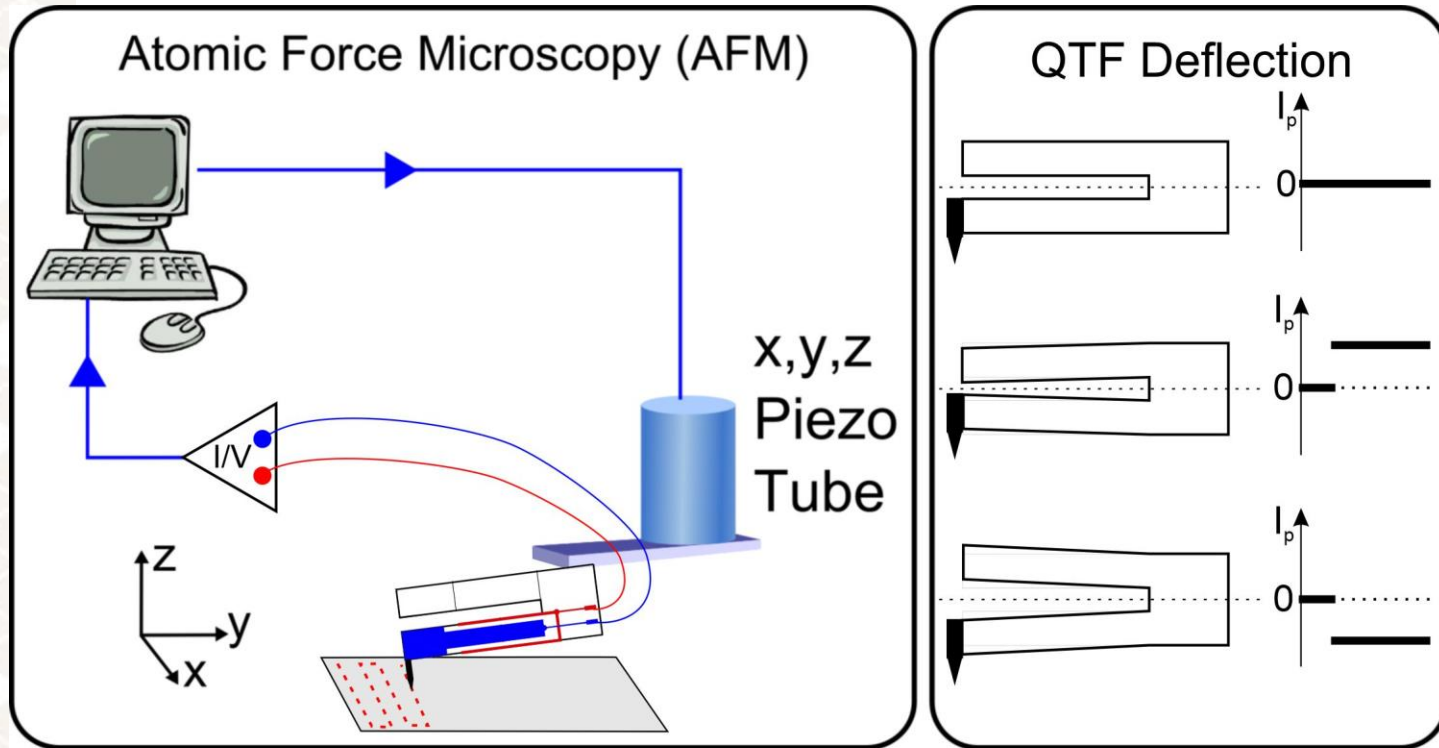

- Here a simple I/V converter is enough to convert the piezoelectric current produced by the quartz upon deflection into a useful measurable voltage
- Detection of the QTF deflection is made much easier compared to cantilevers!

C – AFM in 4 steps (contact mode concept)

1. The probe:
 - a. Cantilever
 - b. Quartz tuning fork
2. Tip-surface interaction forces
3. Detecting the tip-surface interaction force:
 - a. Cantilever
 - b. Quartz tuning fork
4. **Surface scanning and feedback**

C4- Surface scanning & feedback

- Concept, along a single line¹ :

¹ Movie adapted from Park systems: <https://parksystems.com>

Surface Sensing | Detection Method | **Imaging**

Imaging

C4- Surface scanning & feedback

- Concept, along a single line :

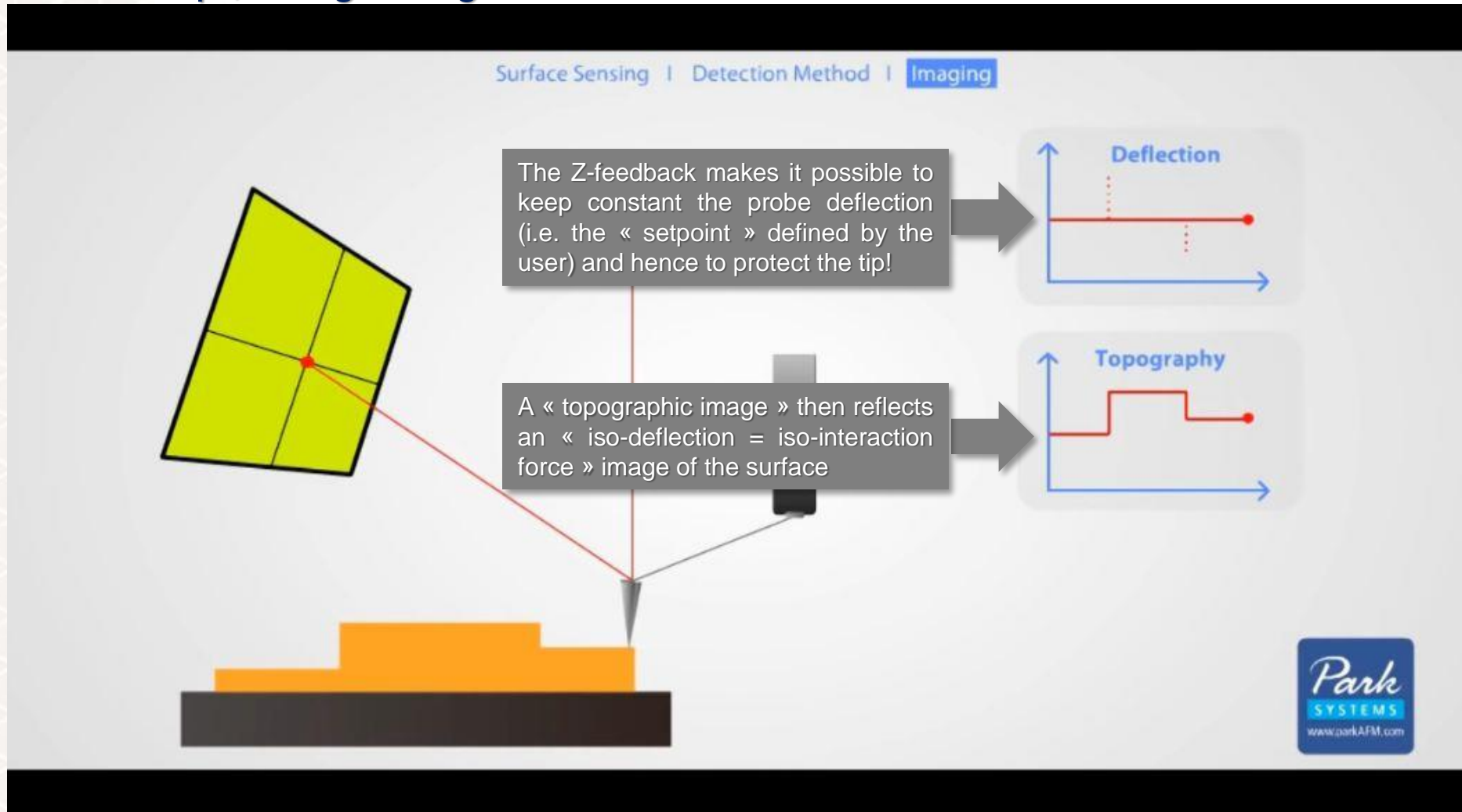

C4- Surface scanning & feedback

- Image topography :

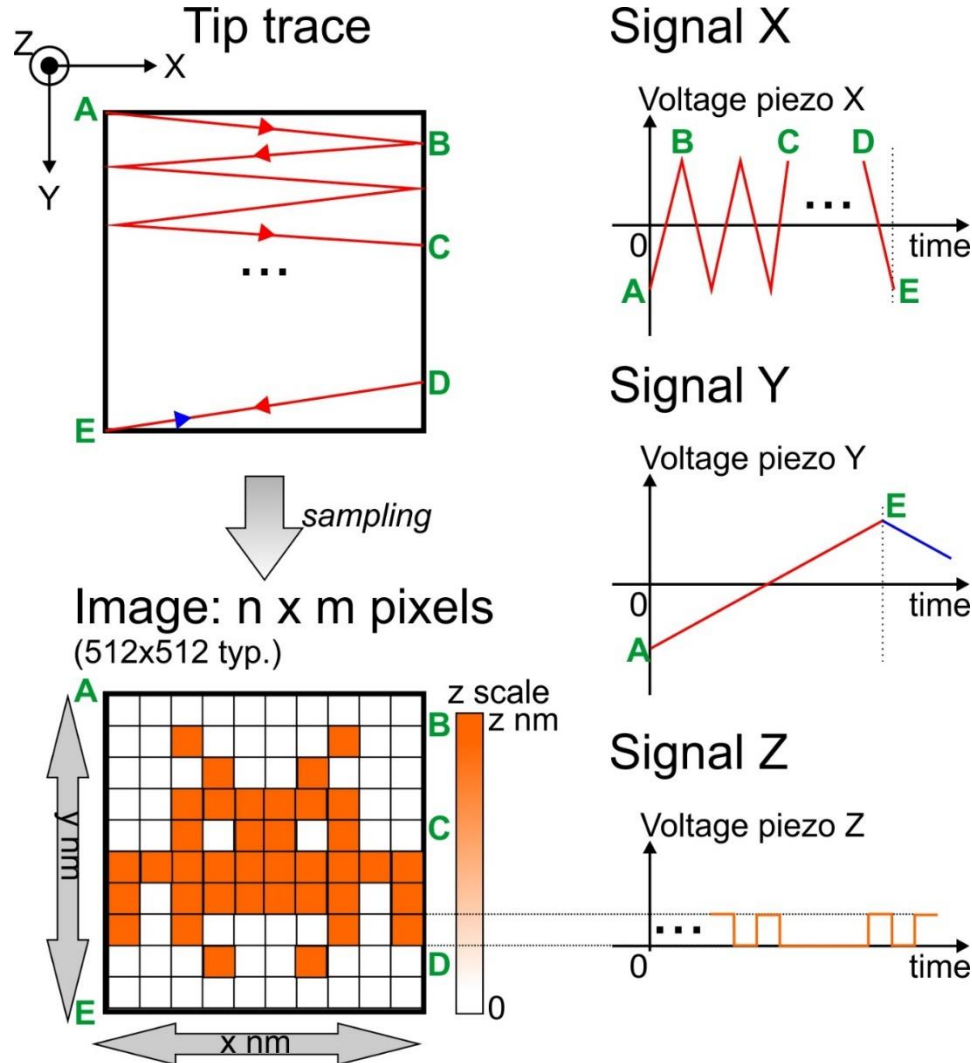

AFM (contact mode concept): summary

- A probe (cantilever / QTF) detects the interaction force that develops between the nanoscopic tip and the surface
- A good mechanical analogy for the probe is the damped harmonic oscillator
- The resulting force ranges typically from 0.1 pN to 10 nN. It consists in a superposition of several components (van der Waals, electrostatic, interatomic) with various ranges of distances (>10 nm, \sim nm, 0.1 nm), first attractive (non-contact), then repulsive (contact).
- Upon the sample surface topography, that force gives rise to a deflection of the probe that can be detected and used as a feedback signal to control the position of the surface while scanning and ultimately form a « topographic » image of the surface

Outline

A. Scanning Probe Microscopies: historical context

B. Ultra-High Vacuum environment

C. AFM in 4 steps (contact mode concept)

D. Dynamic AFM

E. Non-contact AFM

D – Dynamic AFM

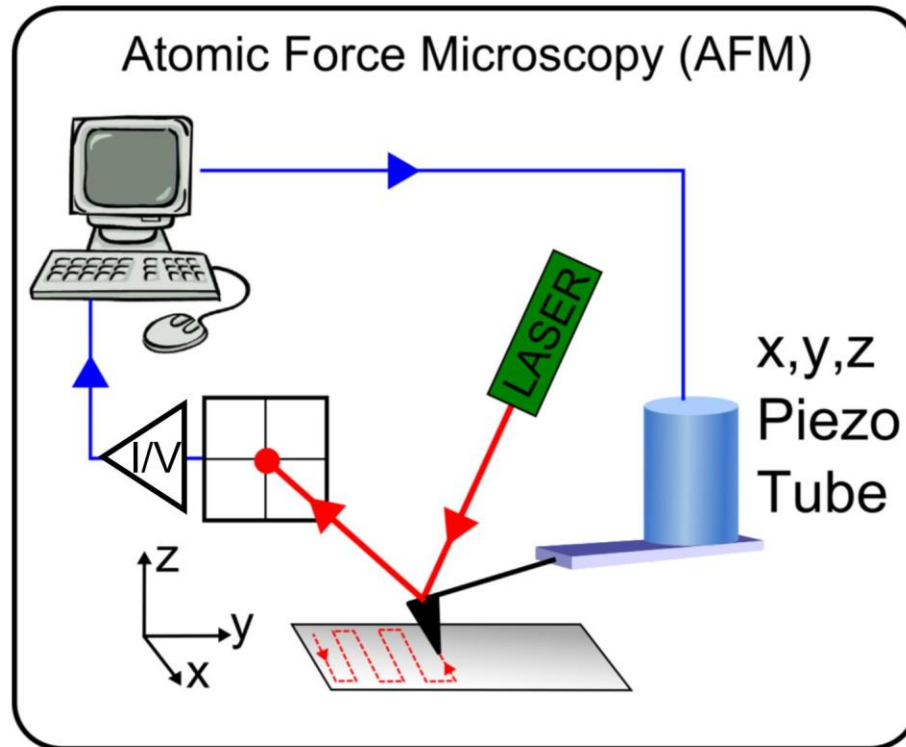

- 1- The probe
- 2- Tip-surface interaction forces
- 3- Detecting the interaction forces
- 4- Scanning & feedback

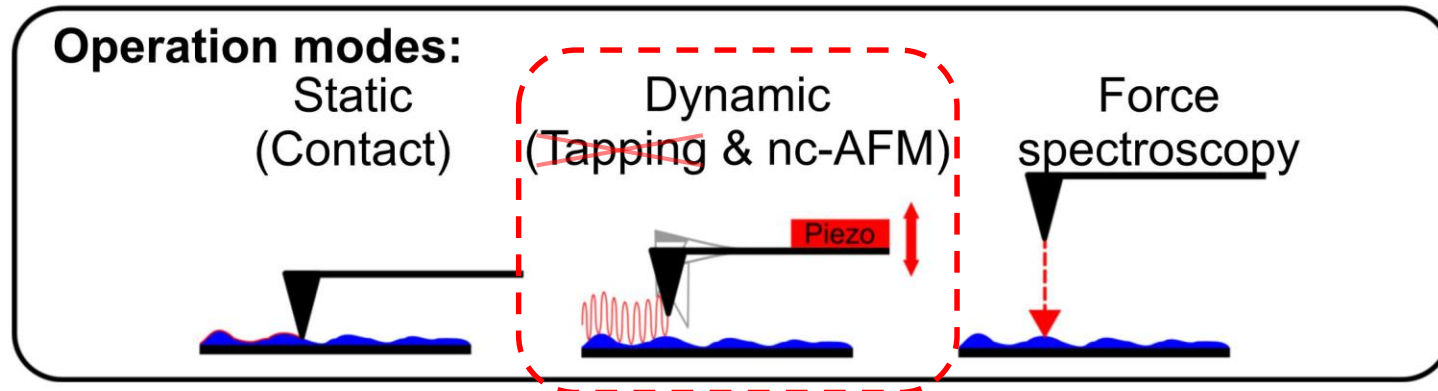

D – Dynamic AFM

1. Specificities
2. Force sensitivity
3. Non-linear dynamics and modelization
4. Towards non-contact AFM

D – Dynamic AFM

1. Specificities
2. Force sensitivity
3. Non-linear dynamics and modelization
4. Towards non-contact AFM

D1- Dynamic AFM specificities

- Question :

What is the pressure that applies on a 1 \AA^2 surface loaded with a 1 nN force?

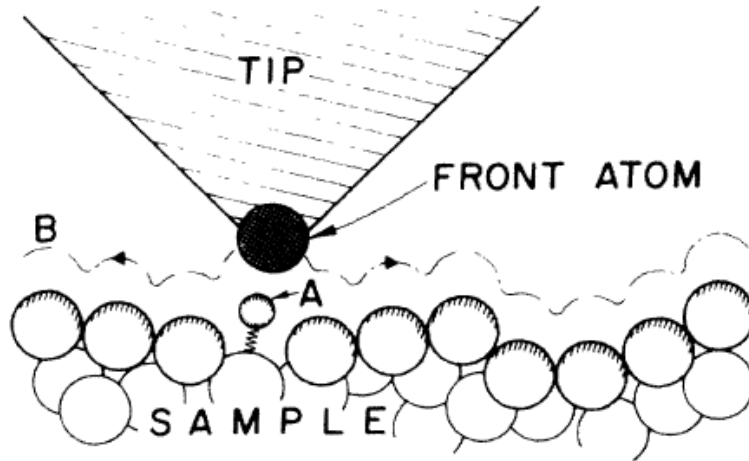

G. Binnig et al., Phys. Rev. Lett. 56, p930 (1986)

D1- Dynamic AFM specificities

- Question :

What is the pressure that applies on a 1 \AA^2 surface loaded with a 1 nN force?

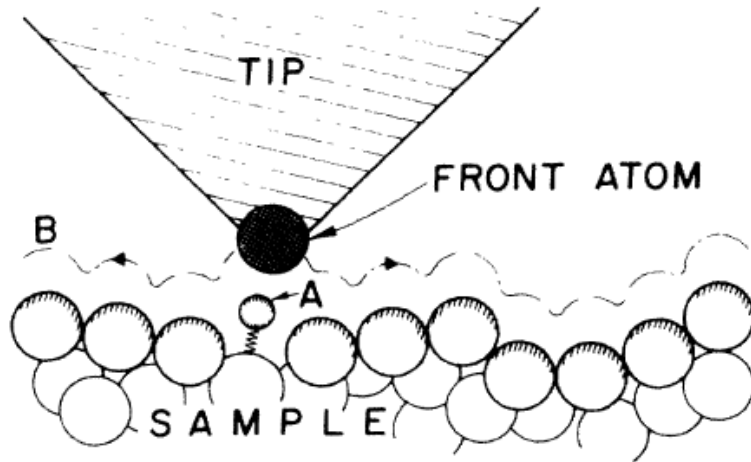

$$P = \frac{F}{s} = \frac{10^{-9} \text{ N}}{(10^{-10} \text{ m})^2} = 100 \text{ GPa}$$

NB: Steel's Young modulus: 200 GPa

G.Binnig et al., Phys. Rev. Lett. 56, p930 (1986)

D1- Dynamic AFM specificities

- Question :

What is the pressure that applies on a 1 \AA^2 surface loaded with a 1 nN force?

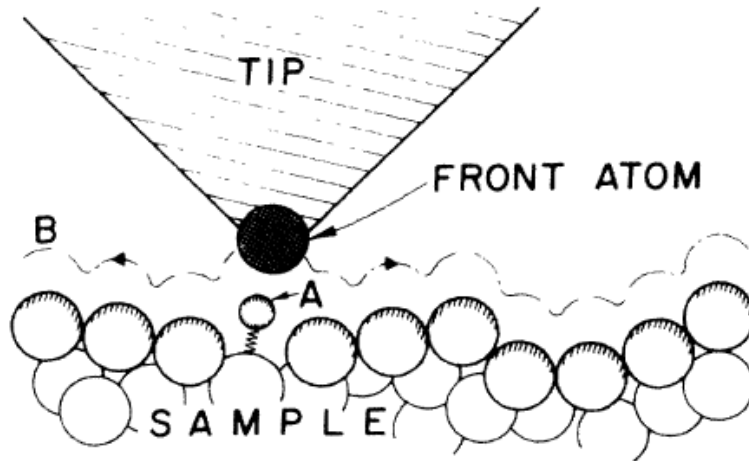

$$P = \frac{F}{s} = \frac{10^{-9} \text{ N}}{(10^{-10} \text{ m})^2} = 100 \text{ GPa}$$

NB: Steel's Young modulus: 200 GPa

- Answer :** tip and/or surface damaging due to contact shear forces while scanning.



G.Binnig et al., Phys. Rev. Lett. 56, p930 (1986)

D1- Dynamic AFM specificities

- Sinusoidal excitation of the probe at a frequency equal or close to the resonance frequency of its fundamental bending mode :
 - **Pros:**
 - ✓ Lowering the shear force between tip and surface
 - ✓ Increasing force sensitivity w.r.t. the contact mode
 - ✓ Non-contact (attractive force mapping only)
 - **Cons:**
 - ✓ Understanding the cantilever dynamics
 - ✓ Detection of the oscillation (detection bandwidth > MHz)
 - ✓ ~~Static deflection~~ : how does the image contrast reflects F_{int} ? Origin of the contrast?
- Measures with the tip-surface distance:
 1. Oscillation frequency f
 2. Oscillation amplitude A
 3. Excitation amplitude A_{exc}
 4. Phase shift between excitation and oscillation φ
- The mechanical system behaves as a forced damped harmonic oscillator (to be checked experimentally)

Fundamental bending mode

Cantilever

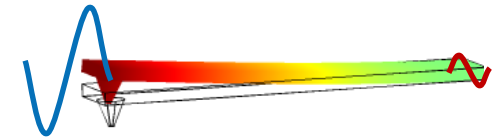

Orders of magnitude:
 Amplitude : 2 nm ... 30 nm
 Frequency: 100 kHz ... 1 MHz

QTF

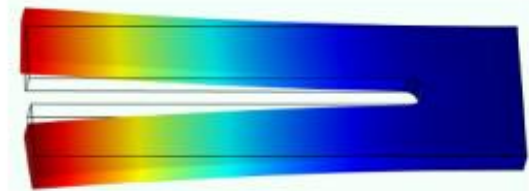

Orders of magnitude:
 Amplitude : 50 pm ... 500 pm
 Frequency: 30 kHz

D – Dynamic AFM

1. Specificities
- 2. Force sensitivity**
3. Non-linear dynamics and modelization
4. Towards non-contact AFM



D2- Force sensitivity

- Question : Relevant forces in AFM are in the nN range. Are these below the minimum force an AFM can detect?
- Conceptually, the **minimum force** the apparatus may detect is the force due to the **thermal fluctuations** of the probe

- The corresponding expression is :

$$F_{\min} = \sqrt{\frac{4kk_B T}{\omega_0 Q}} B \quad (\text{Equ.08})$$

- k : probe stiffness
- $k_B T$: thermal energy (temp. T)
- $\omega_0 = 2\pi f_0$: resonance pulsation
- Q : probe quality factor
- B : measurement bandwidth

- *Orders of magnitude (meas. bandwidth $B \sim 250$ Hz) :*

Parameter	Cantilever		QTF	
Temperature [K]	298	4	298	4
Stiffness k [N/m]	30	30	1800	1800
Resonance f_0 [kHz]	150	150	32	32
Q-factor (UHV)	40000	40000	40000	40000
Thermal force [pN]	0.06	0.007	1	0.1



D2- Force sensitivity

- Tip-surface interaction force :

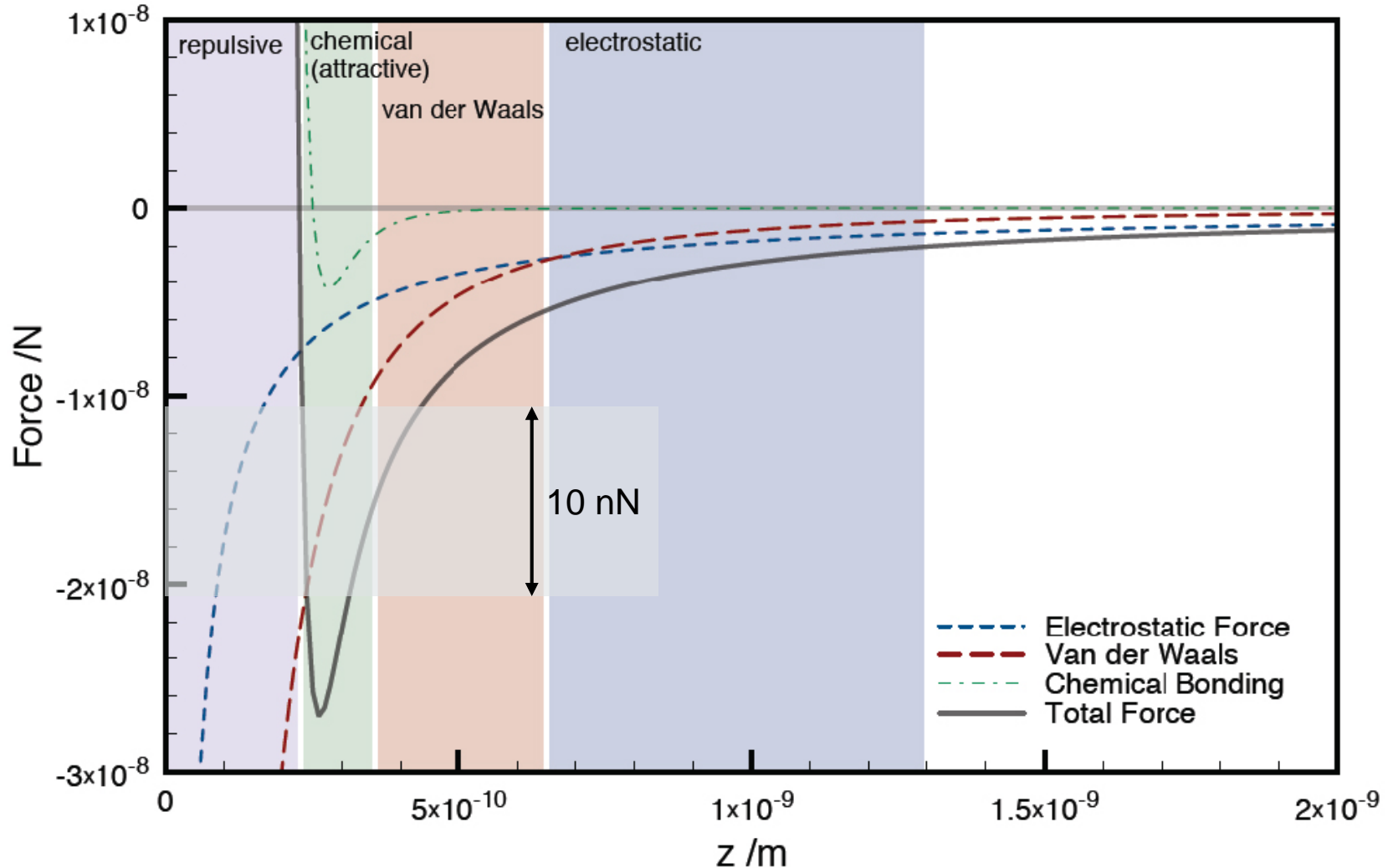



D2- Force sensitivity

- Tip-surface interaction force :

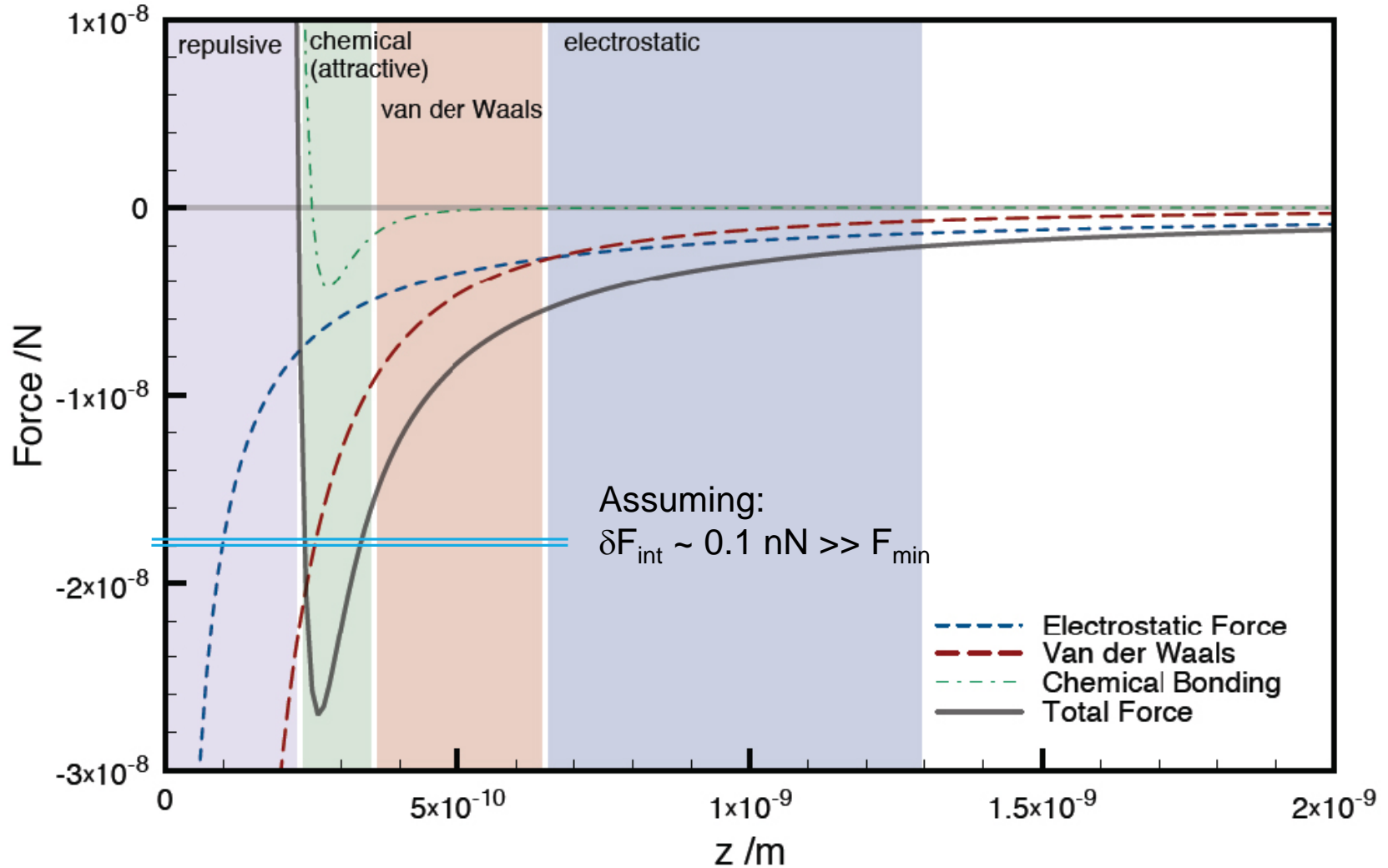



D2- Force sensitivity

- Tip-surface interaction force :

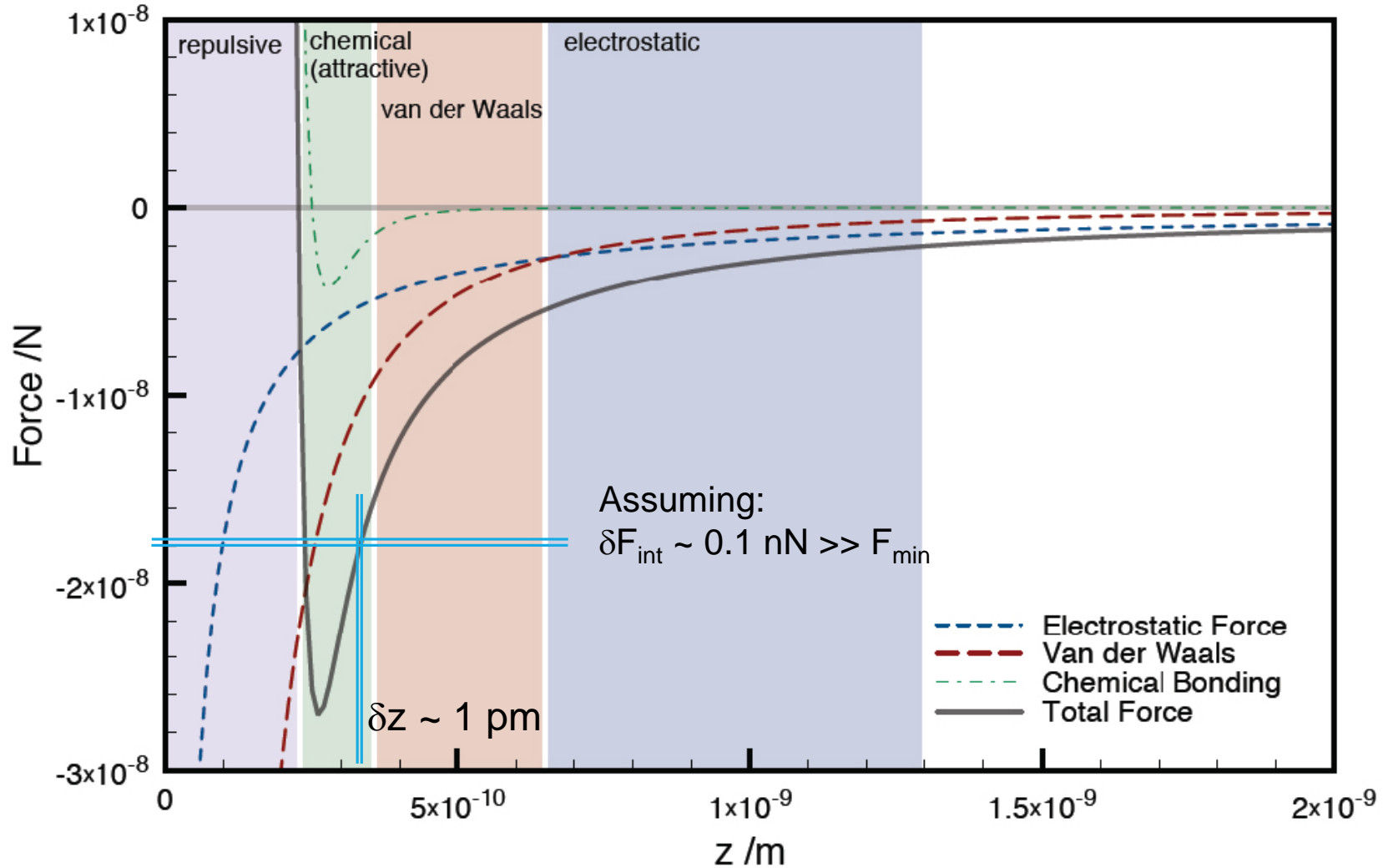



D2- Force sensitivity

- Tip-surface interaction force :

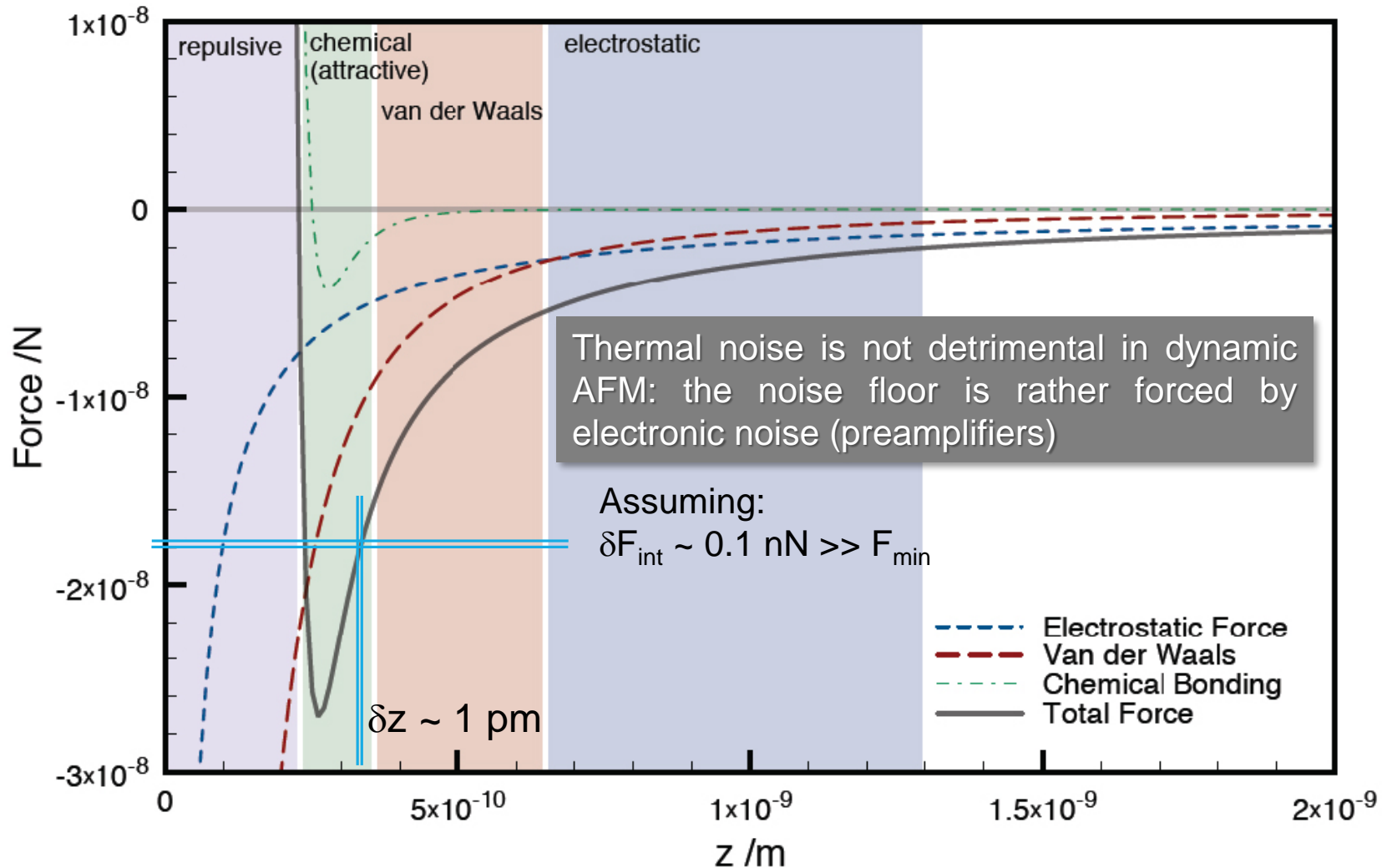

D – Dynamic AFM

1. Specificities
2. Force sensitivity
- 3. Non-linear dynamics and modelization**
4. Towards non-contact AFM

D3- Non-linear dynamics and modelization

- 5 variables : Excitation amplitude A_{exc} , Excitation frequency f (pulsation $\omega = 2\pi f$), Oscillation amplitude A , Phase φ (excitation / oscillation) and Tip-surface distance D

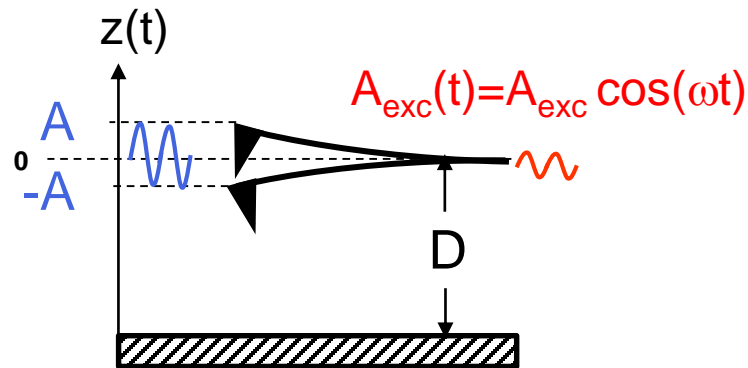

- The probe behaves as a forced damped harmonic oscillator

- Theoretical framework for the free oscillator ($D \rightarrow \infty$, no interaction force) :

Differential equation :

$$\ddot{z}(t) + \frac{\omega_0}{Q} \dot{z}(t) + \omega_0^2 z(t) = \omega_0^2 A_{exc}(t) \quad (\text{Equ.04})$$

Harmonic solution :

$$z(t) = A(\omega) \cos(\omega t + \varphi(\omega)) \quad (\text{Equ.05})$$

Q : Probe quality factor (hint on intrinsic dissipation)

$$Q = 2\pi \frac{\langle E_{stored} \rangle_T}{\langle E_{diss} \rangle_T} = \frac{2\pi f_0}{\Gamma_0} \quad (\text{Equ.06})$$

D3- Non-linear dynamics and modelization

- 5 variables : Excitation amplitude A_{exc} , Excitation frequency f (pulsation $\omega = 2\pi f$), Oscillation amplitude A , Phase φ (excitation / oscillation) and Tip-surface distance D

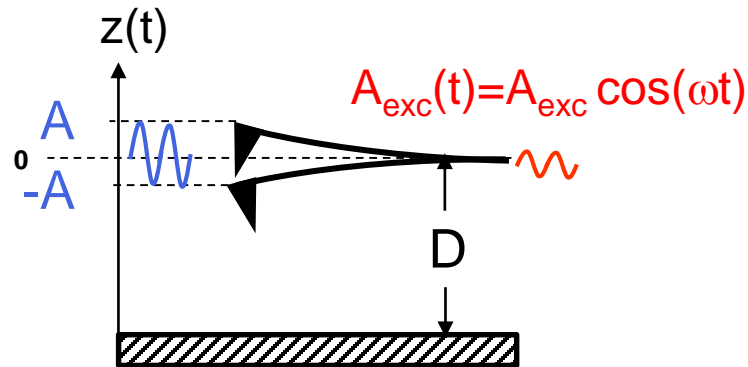

- The probe behaves as a forced damped harmonic oscillator
- Theoretical framework for the free oscillator ($D \rightarrow \infty$, no interaction force) :

Amplitude vs. frequency

$$a \left(u = \frac{f}{f_0} \right) = \frac{A(u)}{A_0} = \frac{1}{\sqrt{Q^2 (1 - u^2)^2 + u^2}} \quad (\text{Equ.07a})$$

Phase vs. frequency

$$\varphi(u) = \arctan \left\{ \frac{u}{Q(u^2 - 1)} \right\} \quad (\text{Equ.07b})$$

D3- Non-linear dynamics and modelization

- Experimental illustration¹ (cantilever, $f_0 = 270$ kHz, $Q = 45000$, UHV) : no interaction force with the surface ($D \rightarrow \infty$)

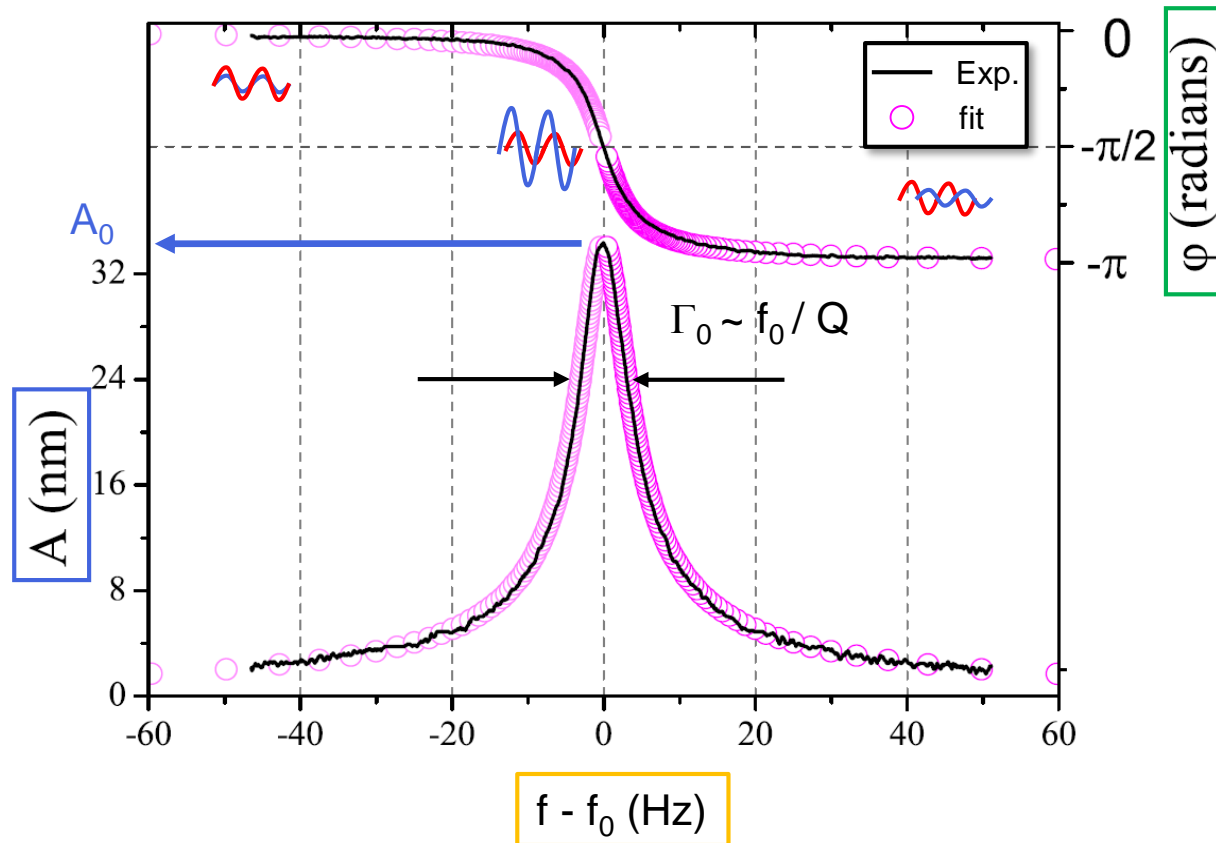

¹ Polesel *et al.*, Nanotechnology **14**,1036 (2003)

D3- Non-linear dynamics and modelization

- Experimental illustration¹ (cantilever, $f_0 = 270$ kHz, $Q = 45000$, UHV) : no interaction force with the surface ($D \rightarrow \infty$)

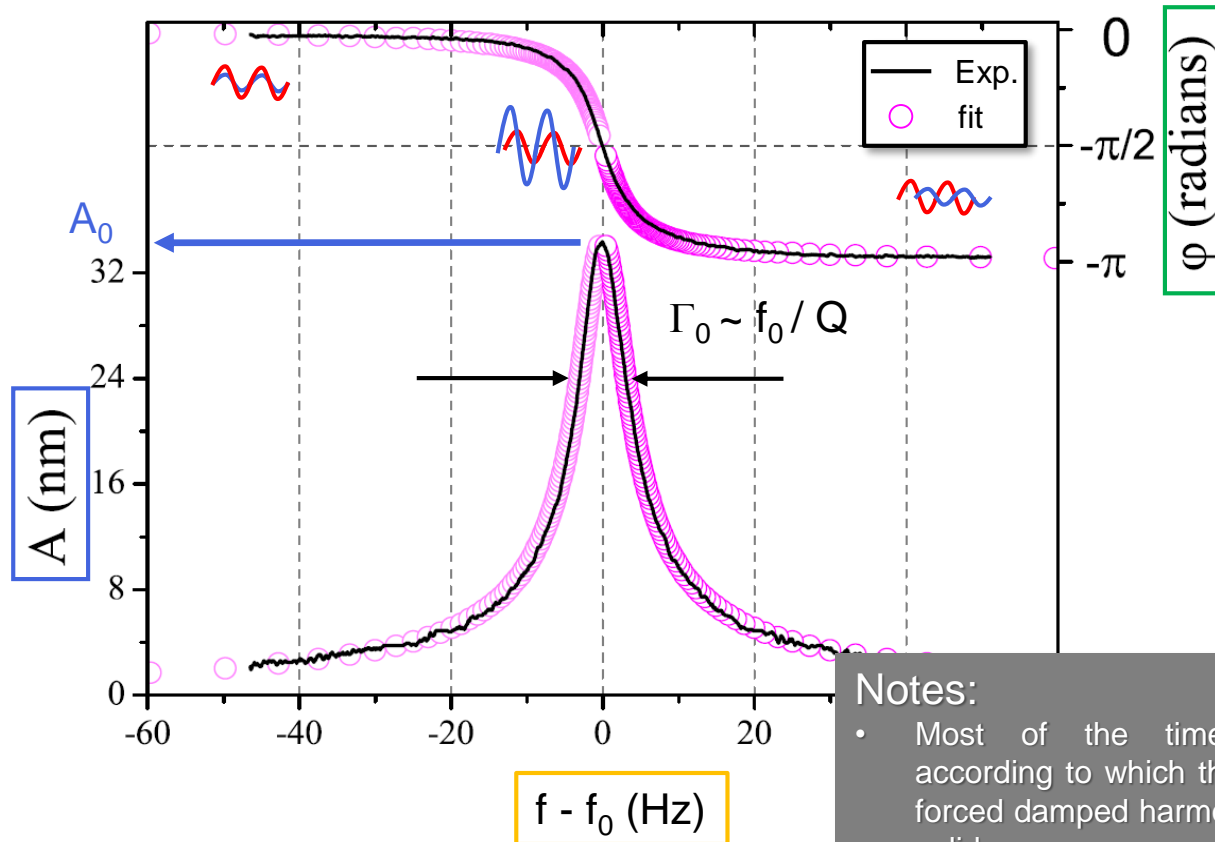

Notes:

- Most of the time, the assumption according to which the probe behaves as forced damped harmonic oscillator is well-valid
- $Q = 45000$ & $f_0 = 270$ kHz $\rightarrow \Gamma_0 = 6$ Hz : sharp resonances ! (UHV-forced)

¹ Polesel *et al.*, *Nanotechnology* **14**,1036 (2003)

D3- Non-linear dynamics and modelization

- Question : how does the interaction force change the probe dynamic?

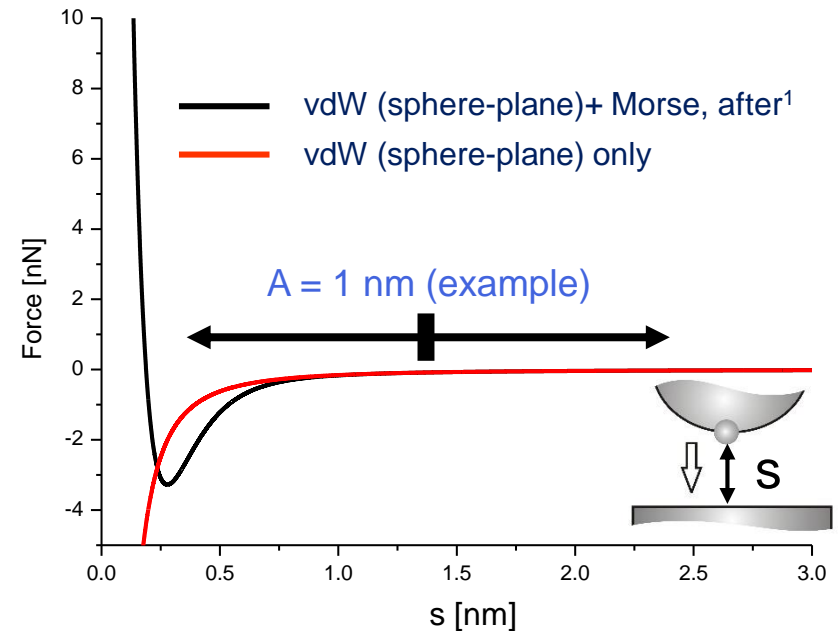
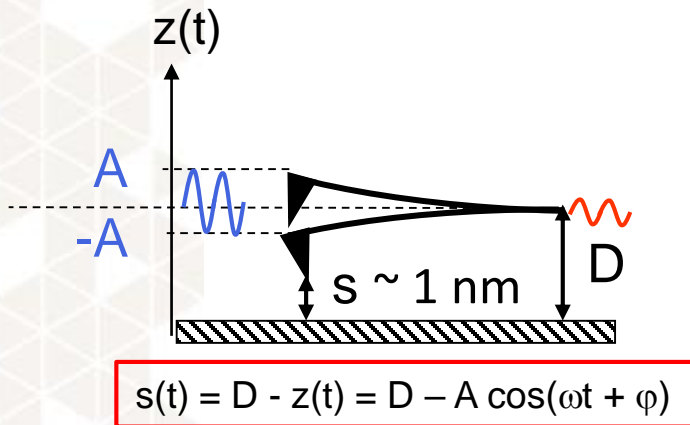

- Theoretical framework :

$$\text{(Equ.09)} \quad \ddot{z}(t) + \frac{\omega_0}{Q} \dot{z}(t) + \omega_0^2 z(t) = \omega_0^2 A_{\text{exc}}(t) + \frac{\omega_0^2 F_{\text{int}}(t)}{k_c} : F_{\text{int}} \text{ is non-linear in } z$$

$$z(t) = A(\omega) \cos(\omega t + \varphi(\omega)) \quad : \text{non solution}$$

$$A(\omega), \varphi(\omega) \rightarrow A(\omega, D), \varphi(\omega, D) \quad : D \text{ dependence}$$

¹Pérez *et al.*, Phys Rev. B **58**, 10835 (1998)

D3- Non-linear dynamics and modelization

- Experimental illustration¹ (cantilever, $f_0 = 270$ kHz, $Q = 45000$, UHV) : interaction force with the surface ($D - A_0 \sim 1$ nm)

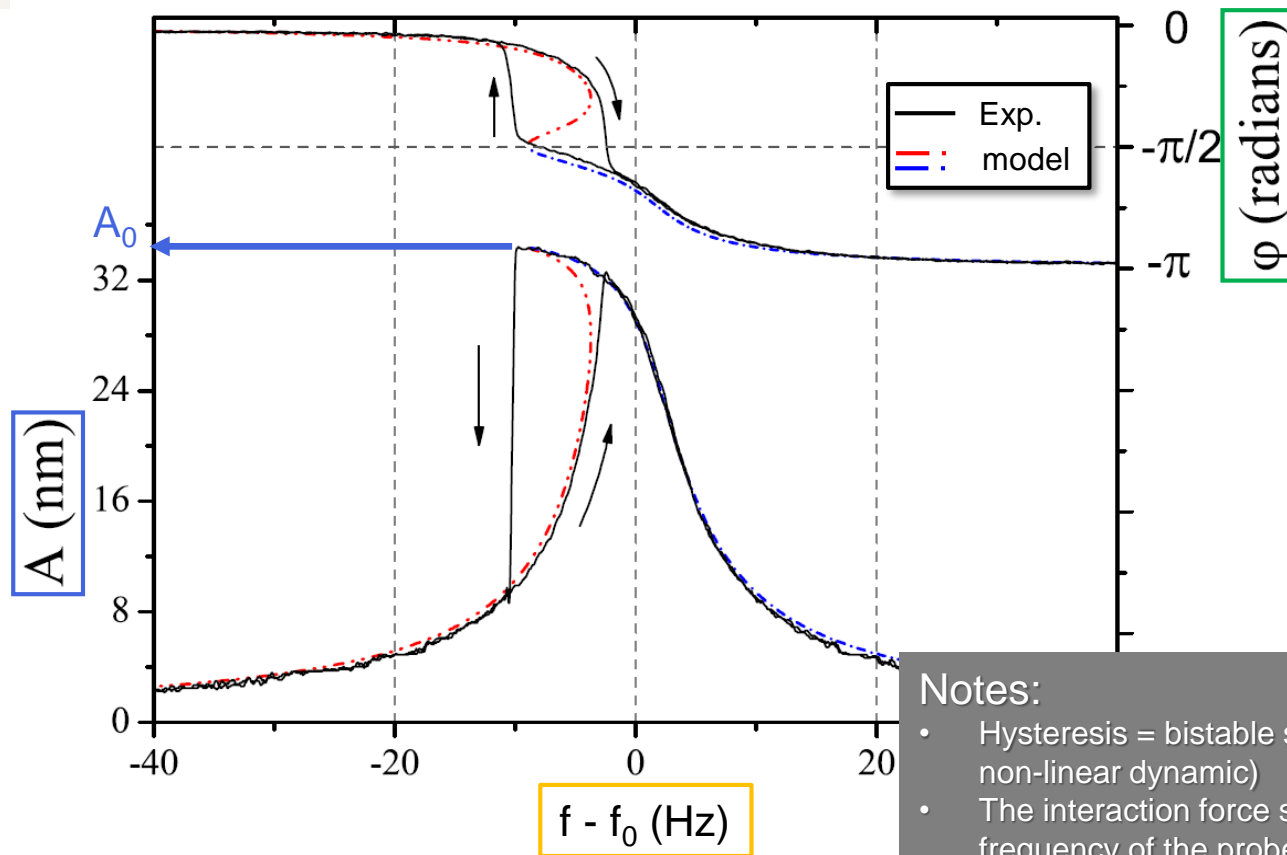

Notes:

- Hysteresis = bistable structure (typical of a non-linear dynamic)
- The interaction force shifts the resonance frequency of the probe (negatively for an attractive force and vice-versa)

¹Polesel *et al.*, *Nanotechnology* **14**:1036 (2003)

D3- Non-linear dynamics and modelization

- Modelization : variational method & least action principle¹

$$\delta S = \delta \left[\int_0^{1/f} L(z, \dot{z}, t) \right] = 0 \quad (\text{Equ.10})$$

$$L \left[z(t), \dot{z}(t) \right] = T - V + W$$

$$= \frac{1}{2} \frac{k_c}{(2\pi f_0)^2} \dot{z}(t)^2 - \left[\frac{1}{2} k_c z(t)^2 - z(t) k_c A_x \cos(2\pi f t) + V_c^{int}(z(t)) \right]$$

$$- \left[\frac{\Gamma_0 k_c}{(2\pi f_0)^2} z(t) \dot{z}(t) + V_d^{int}(z(t), \dot{z}(t)) \right] \quad (\text{Equ.11})$$

- Harmonic trial function : $z(t) = A \cos(2\pi f t + \varphi)$

$$\delta A \Leftrightarrow \cos(\varphi) = \frac{A}{A_x} \left(1 - \frac{f^2}{f_0^2} \right) + \frac{2}{k_c A_x} \langle F_c \rangle \quad (\text{Equ.12a})$$

$$\delta \varphi \Leftrightarrow \sin(\varphi) = -\frac{f}{f_0} \times \frac{A}{Q A_x} - \frac{2}{k_c A_x} \langle F_d \rangle \quad (\text{Equ.12b})$$

Conservative coupling term

Dissipative coupling term

¹L.Nony *et al.* J.Chem.Phys.111,1610 (1999)

D3- Non-linear dynamics and modelization

- Modelization : variational method & least action principle¹

$$\delta S = \delta \left[\int_0^{1/f} L(z, \dot{z}, t) \right] = 0 \quad (\text{Equ.10})$$

$$L \left[z(t), \dot{z}(t) \right] = T - V + W$$

$$= \frac{1}{2} \frac{k_c}{(2\pi f_0)^2} \dot{z}(t)^2 - \left[\frac{1}{2} k_c z(t)^2 - z(t) k_c A_x \cos(2\pi f t) + V_c^{int}(z(t)) \right]$$

$$- \left[\frac{\Gamma_0 k_c}{(2\pi f_0)^2} z(t) \dot{z}(t) + V_d^{int}(z(t), \dot{z}(t)) \right] \quad (\text{Equ.11})$$

- Harmonic trial function : $z(t) = A \cos(2\pi f t + \varphi)$

$$\delta A \Leftarrow \cos(\varphi) = \frac{A}{A_x} \left(1 - \frac{f^2}{f_0^2} \right) + \frac{2}{k_c A_x} \langle F_c \rangle \quad (\text{Equ.12a})$$

Conservative coupling term

$$\delta \varphi \Leftarrow \sin(\varphi) = -\frac{f}{f_0} \times \frac{A}{Q A_x} - \frac{2}{k_c A_x} \langle F_d \rangle \quad (\text{Equ.12b})$$

Dissipative coupling term

¹L.Nony *et al.* J.Chem.Phys.111,1610 (1999)

D3- Non-linear dynamics and modelization

- Coupling terms (Fourier components of the interaction force @ f) :

$$\left\langle F_{\text{int}}^c \right\rangle = -f \times \int_0^{1/f} \frac{\partial}{\partial A} V_{\text{int}}^c(z(t)) dt = \frac{1}{2\pi} \int_0^{2\pi} F_{\text{int}}^c(D - A \cos(u)) \cos(u) du \quad (\text{Equ.13a})$$

$$\left\langle F_{\text{int}}^d \right\rangle = -\frac{f}{A} \int_0^{1/f} \frac{\partial}{\partial \varphi} V_{\text{int}}^d(z(t); \dot{z}(t)) dt = \frac{1}{2\pi} \int_0^{2\pi} F_{\text{int}}^d(D - A \cos(u)) \sin(u) du \quad (\text{Equ.13b})$$

D3- Non-linear dynamics and modelization

- Coupling terms (Fourier components of the interaction force @ f) :

$$\left\langle F_{\text{int}}^c \right\rangle = -f \times \int_0^{1/f} \frac{\partial}{\partial A} V_{\text{int}}^c(z(t)) dt = \frac{1}{2\pi} \int_0^{2\pi} F_{\text{int}}^c(D - A \cos(u)) \cos(u) du \quad (\text{Equ.13a})$$

$$\left\langle F_{\text{int}}^d \right\rangle = -\frac{f}{A} \int_0^{1/f} \frac{\partial}{\partial \varphi} V_{\text{int}}^d(z(t); \dot{z}(t)) dt = \frac{1}{2\pi} \int_0^{2\pi} F_{\text{int}}^d(D - A \cos(u)) \sin(u) du \quad (\text{Equ.13b})$$

- Interaction potential :

$$V_{\text{int}}^c = V_{\text{Lr}} + V_{\text{Sr}} + V_{\text{Elec}} + V_{\text{Magn}} \quad (\text{Equ.14a})$$

$$V_{VdW}(t) = -\frac{HR}{6(D - z(t))} \quad (\text{Equ.14b})$$

Long-range:
Dispersive van der Waals

$$V_{Morse}(t) = -U_0 \left[2e^{-\frac{D-z(t)-r_c}{\lambda}} - e^{-\frac{2(D-z(t)-r_c)}{\lambda}} \right] \quad (\text{Equ.14c})$$

Short-range:
Morse

D – Dynamic AFM

1. Specificities
2. Force sensitivity
3. Non-linear dynamics and modelization
- 4. Towards non-contact AFM**

D4- Towards non-contact AFM

- 5 variables : Excitation amplitude A_{exc} , Excitation frequency f (pulsation $\omega = 2\pi f$), Oscillation amplitude A , Phase φ (excitation / oscillation) and Tip-surface distance D
- The non-linear dynamics of the probe is accounted for by the system $\{\cos(\varphi), \sin(\varphi)\}$ (cf. equs. 12)
- The variables that are kept constant in this system set the operation mode :

*non-contact AFM*¹



Phase φ ($=-\pi/2$: resonance) **and**
Oscillation amplitude A are constant



system $\{\cos(\varphi), \sin(\varphi)\}$ solved w.r.t f and $A_{\text{exc}}\dots$

¹ T.Albrecht *et al.*, J.Appl.Phys.**69**, 668 (1991)

Dynamic AFM : summary

- To avoid damaging the surface and/or the tip upon contact, it is worth using *dynamic* rather than *static* AFM
- Then, the probe is brought into oscillation at a frequency close, or equal, to the one of its fundamental bending mode
- Owing to the non-linear character of the tip-surface interaction force, the probe exhibits a non-linear dynamics that may be well-understood when assuming that it behaves as forced damped harmonic oscillator
- Controlling the oscillation parameters of the probe such as its **excitation amplitude**, **oscillation amplitude**, **phase** and **frequency** set the dynamical operation mode
- In non-contact AFM, the **phase** and the **oscillation amplitude** are kept constant. The phase is set to $-\pi/2$ (resonance condition)

Outline

- A. Scanning Probe Microscopies: historical context
- B. Ultra-High Vacuum environment
- C. AFM in 4 steps (contact mode concept)
- D. Dynamic AFM
- E. Non-contact AFM

E – Non-contact AFM

1. Concept
2. Connection with the modelization
3. Experimental illustrations
4. Instrumentation: PLL & amplitude regulation
5. Main worldwide nc-AFM groups (experimental)

E – Non-contact AFM

1. Concept
2. Connection with the modelization
3. Experimental illustrations
4. Instrumentation: PLL & amplitude regulation
5. Main worldwide nc-AFM groups (experimental)

E1- Concept

Phase ($=-\pi/2$: resonance) and oscillation amplitude A_0 (resonance) are constant

- *Measures* :

- resonance frequency shift : $\Delta f = \tilde{f}_0 - f_0$
- excitation amplitude required to keep the oscillation amplitude A_0 constant

- *Probed interaction* : most generally, attractive interaction force (non-contact)

- *z feedback (Topography image)* : performed to keep Δf constant (more conceptual than the probe deflection)

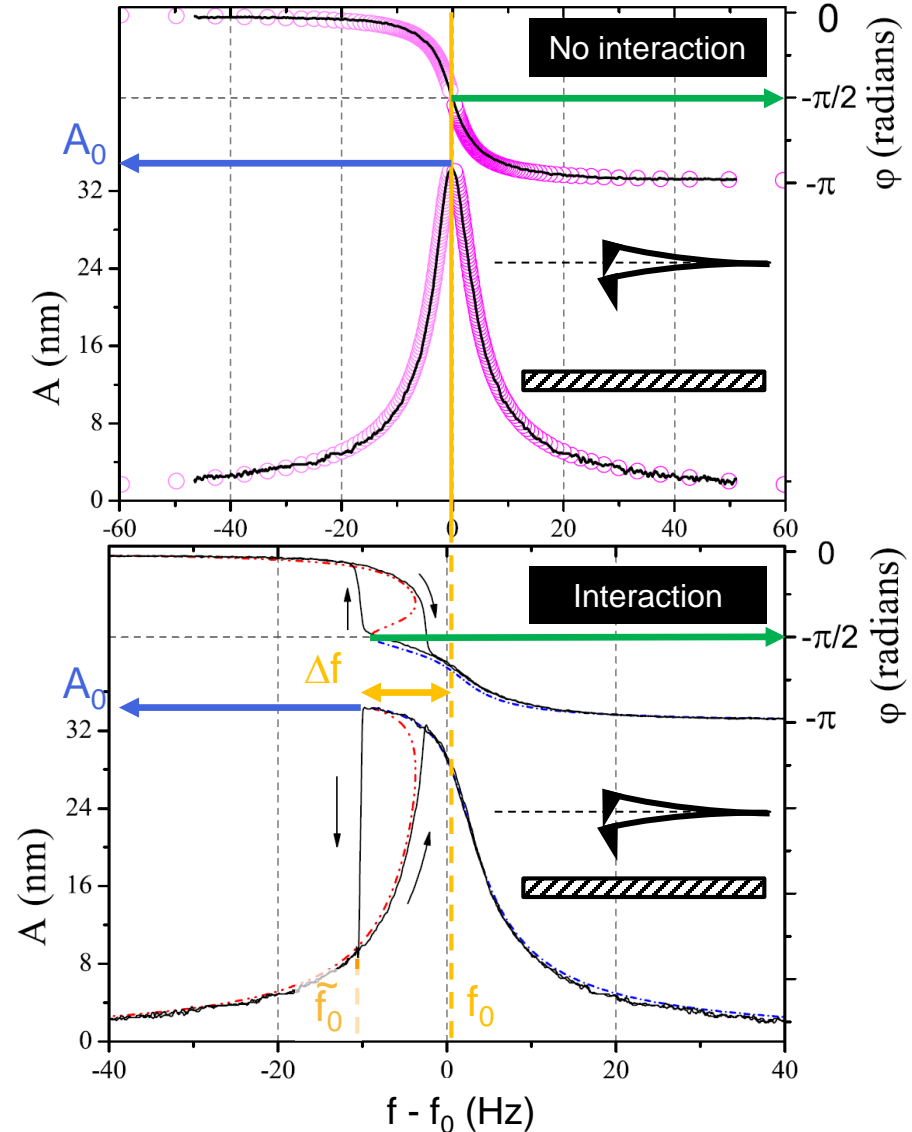

E1- Concept

- Back to the feedback :

Surface Sensing | Detection Method | **Imaging**

Δf

A « topographic image » then reflects an « iso- Δf » image of the surface

~~Deflection~~

Topography

Park
SYSTEMS
www.parkAFM.com



Reference / review papers & books

- “Noncontact Atomic Force Microscopy” (S.Morita, F. Giessibl, E. Meyer, R. Wiesendanger Editors), Springer-Verlag Berlin Heidelberg, Vol.1 (2002), Vol.2 (2009), Vol.3 (2015)

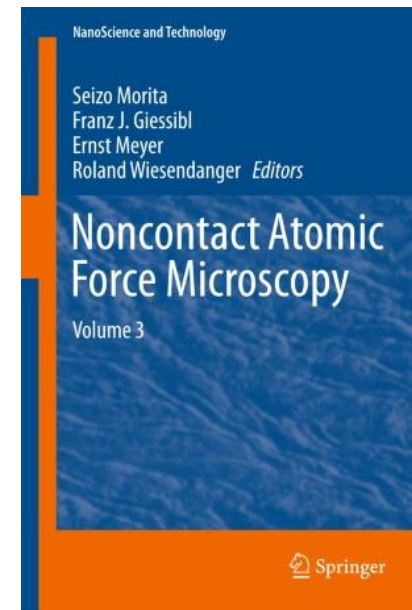
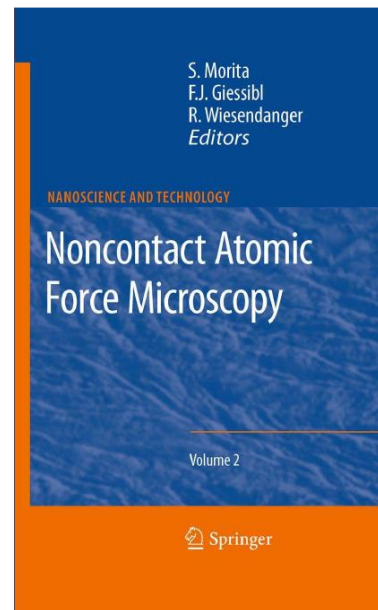
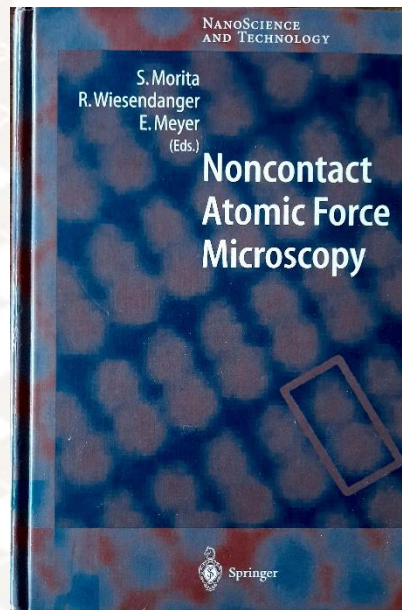

E – Non-contact AFM

1. Concept
- 2. Connection with the modelization**
3. Experimental illustrations
4. Instrumentation: PLL & amplitude regulation
5. Main worldwide nc-AFM groups (experimental)

E2- Connection with the modelization (1)

- Oscillation amplitude ($=A_0$) and phase ($=-\pi/2$) are forced : solving the system $\{\cos(\varphi), \sin(\varphi)\}$ (cf. equ.12a & b) w.r.t. $f \rightarrow \tilde{f}_0$ and A_{exc} .
- Regarding conservative interactions \rightarrow frequency shift : $\Delta f = \tilde{f}_0 - f_0$

$$\frac{\Delta f}{f_0} = -\frac{1}{2\pi k_c A_0} \int_0^{2\pi} F_{int}^c(D + A_0 \cos(u)) \cos(u) du \quad (\text{Equ.15})$$

with : $F_{int}^c(z) = -\frac{\partial}{\partial z} V_{int}^c(z)$ and

$$\begin{cases} V_{VdW}(t) = -\frac{HR}{6(D - z(t))} \\ V_{Morse}(t) = -U_0 \left[2e^{-\frac{D-z(t)-r_c}{\lambda}} - e^{-\frac{2(D-z(t)-r_c)}{\lambda}} \right] \end{cases} \quad (\text{Equ.16})$$

- Hence the analytic expression for Δf :

$$\frac{\Delta f}{f_0} = -\frac{1}{k_c A_0} \left[\frac{HRA_0}{6(D^2 - A_0^2)^{3/2}} + \frac{2U_0}{\lambda} (Y_{1,1/\lambda} - Y_{1,2/\lambda}) \right] \quad (\text{Equ.17})$$

Long-range

Short-range



Reference / review papers & books

- “Forces and frequency shifts in atomic-resolution dynamic-force microscopy”

F.J. Giessibl, *Phys. Rev. B* **56**(24), 16010–16015 (1997)

- “Relations between interaction force and frequency shift in large amplitude dynamic force microscopy”

U. Dürig, *Appl. Phys. Lett.* **75**(3), 433 (1999)

- “Nonlinear dynamical properties of an oscillating tip-cantilever system in the tapping mode”

L. Nony *et al.*, *J. Chem. Phys.* **111**(4) , 1615–1627 (1999)

- “Noncontact atomic force microscopy simulator with phase-locked-loop controlled frequency detection and excitation”

L. Nony *et al.*, *Phys. Rev. B* **74**, 235439, (2006)

E2- Connection with the modelization (1)

- $\Delta f / f_0$ as a function of the normalized tip-surface distance $d = D / A_0$ (van der waals interaction force only):

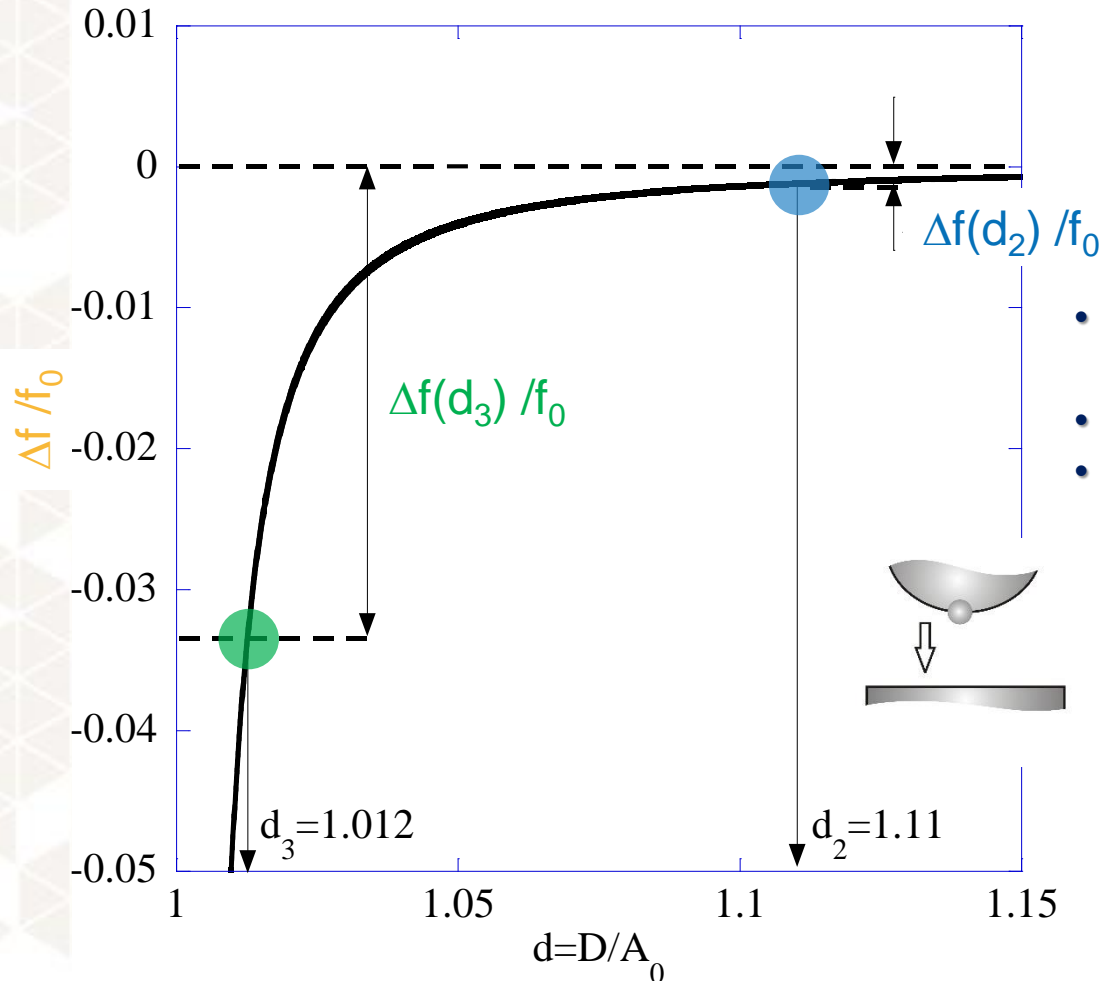

- Rapid change of Δf with the distance (« exponential-like »)
- Similar to tunneling current in STM
- Δf always negative with an attractive interaction force (= non-contact situation)

Orders of magnitude (cantilevers):

$A_0 = 5 \text{ nm}$

$f_0 = 150 \text{ kHz}$

$k = 30 \text{ N/m}$

$\Delta f(D_2 = 5.55 \text{ nm}) = -150 \text{ Hz}$

$\Delta f(D_3 = 5.06 \text{ nm}) = -4800 \text{ Hz!}$



E2- Connection with the modelization (2)

- Question : How is the information of the tip-surface interaction force concealed in the Δf ?
- The calculation of the frequency shift can be simplified upon linearization of the interaction force by assuming small oscillation amplitudes ($A \sim 50 \text{ pm} \ll D$).

$$F_{\text{int}}(t) = F_{\text{int}}(s(t)) = F_{\text{int}}(D - z(t)) \simeq \left. \frac{\partial F_{\text{int}}(s)}{\partial s} \right|_{s_{\text{min}}=D-A_0} s(t) \quad (\text{Equ.18})$$

- In this case, we can prove that the interaction-shifted resonance frequency simplifies to :

$$\tilde{f}_0 = f_0 \sqrt{1 - \frac{1}{k} \left. \frac{\partial F_{\text{int}}}{\partial s} \right|_{s_{\text{min}}}} \quad (\text{Equ.19})$$

- Assuming $k \gg \partial F_{\text{int}} / \partial s$, we get the linearized formula for the frequency shift :

$$\frac{\tilde{f}_0 - f_0}{f_0} = \frac{\Delta f}{f_0} = -\frac{1}{2k} \left. \frac{\partial F_{\text{int}}}{\partial s} \right|_{s_{\text{min}}} \quad (\text{Equ.20})$$



E2- Connection with the modelization (2)

- Question : How is the information of the tip-surface interaction force concealed in the Δf ?
- The calculation of the frequency shift can be simplified upon linearization of the interaction force by assuming small oscillation amplitudes ($A \sim 50 \text{ pm} \ll D$).

$$F_{\text{int}}(t) = F_{\text{int}}(s(t)) = F_{\text{int}}(D - z(t)) \simeq \left. \frac{\partial F_{\text{int}}(s)}{\partial s} \right|_{s_{\text{min}}=D-A_0} s(t) \quad (\text{Equ.18})$$

- In this case, we can For small oscillation amplitudes and with stiff probes such as QTF, the frequency shift is proportionnal to the interaction force gradient. frequency simplifies to :

$$f_0 = f_0 \sqrt{1 - \frac{1}{k} \left. \frac{\partial F_{\text{int}}}{\partial s} \right|_{s_{\text{min}}}} \quad (\text{Equ.19})$$

- Assuming $k \gg \partial F_{\text{int}} / \partial s$, we get the linearized formula for the frequency shift :

$$\frac{\tilde{f}_0 - f_0}{f_0} = \frac{\Delta f}{f_0} = -\frac{1}{2k} \left. \frac{\partial F_{\text{int}}}{\partial s} \right|_{s_{\text{min}}} \quad (\text{Equ.20})$$

E2- Connection with the modelization (3)

- Vertical sensitivity in the short-range regime (order of magnitude):

$$\delta z / \delta \Delta f \sim 10 \text{ pm} / \text{Hz}$$

- The experimental control on Δf is better than 0.1 Hz (around $f_0 \sim 150 \text{ kHz}$), i.e. **1 pm vertical resolution !**
- This is what is achieved at **low temperature** (LHe, 4K).
- At **room temperature**, the noise level of the instrument (amplitude detection...) exceeds that value. The resolution is rather 10 pm.
- This sensitivity is enough to achieve atomic resolution at room temperature too

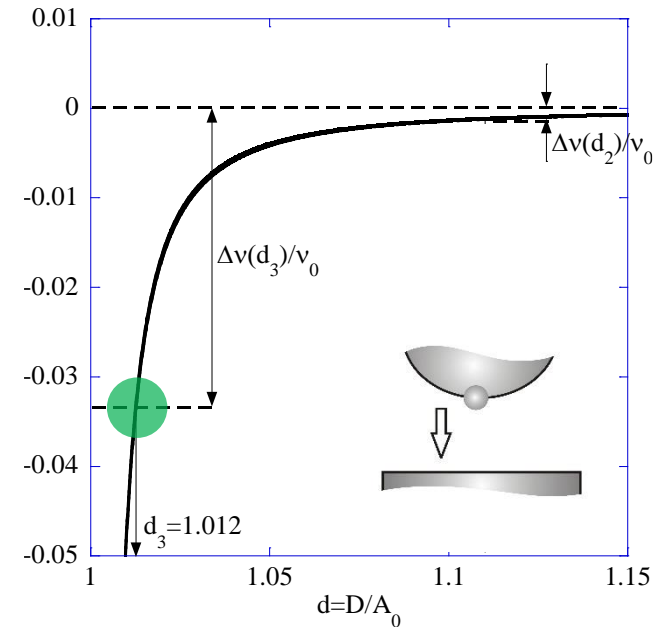

E – Non-contact AFM

1. Concept
2. Connection with the modelization
- 3. Experimental illustrations**
4. Instrumentation: PLL & amplitude regulation
5. Main worldwide nc-AFM groups (experimental)

E3- Experimental illustrations

- Δf as a function of the tip-surface distance measured on Cu(111) surface (QTF, $A_0 = 50$ pm, $f_0 = 23$ kHz, $Q = 40000$, $k = 1800$ N/m) :

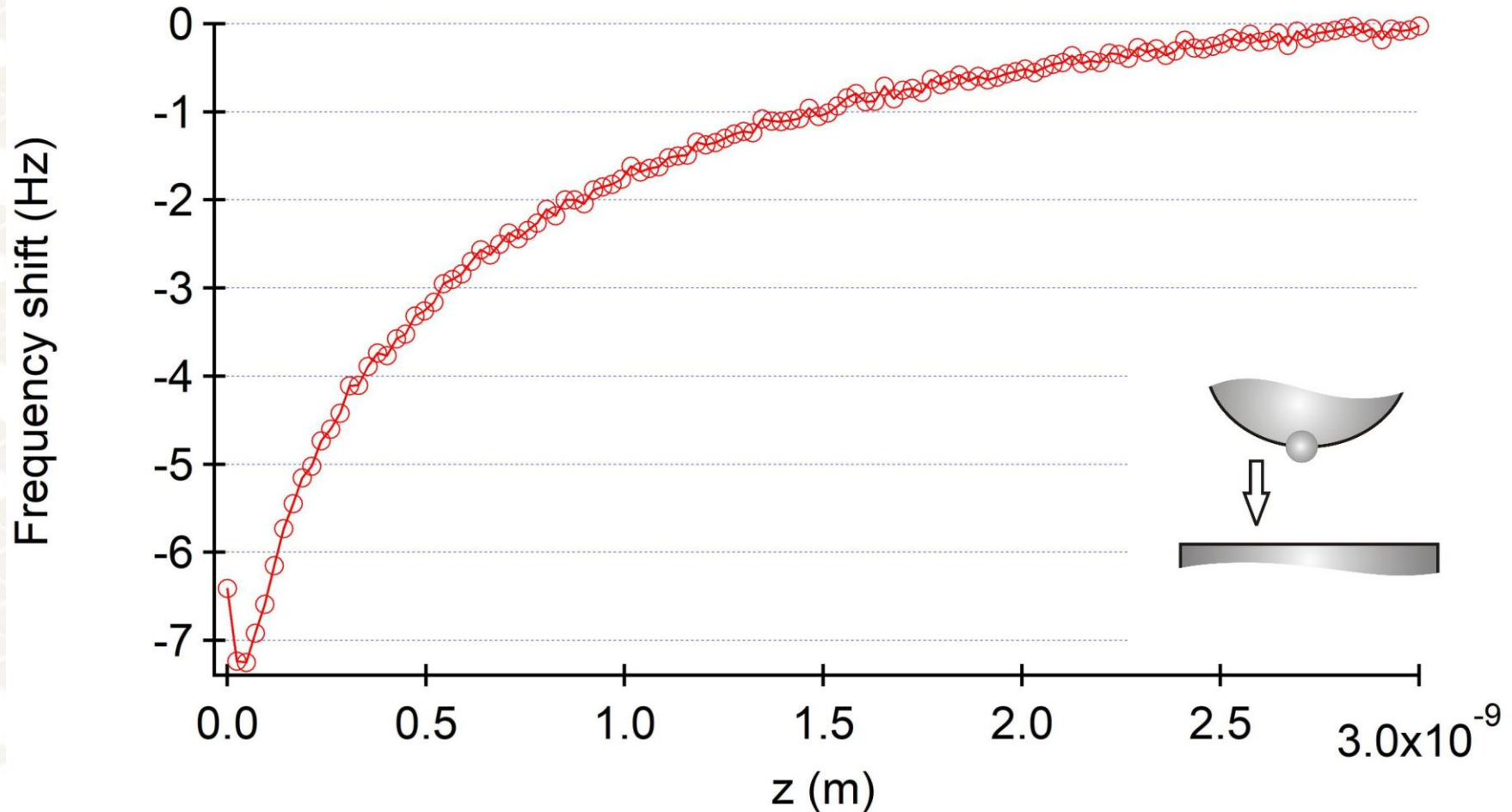

E3- Experimental illustrations

- Δf as a function of the tip-surface distance measured on Cu(111) surface (QTF, $A_0 = 50$ pm, $f_0 = 23$ kHz, $Q = 40000$, $k = 1800$ N/m) :

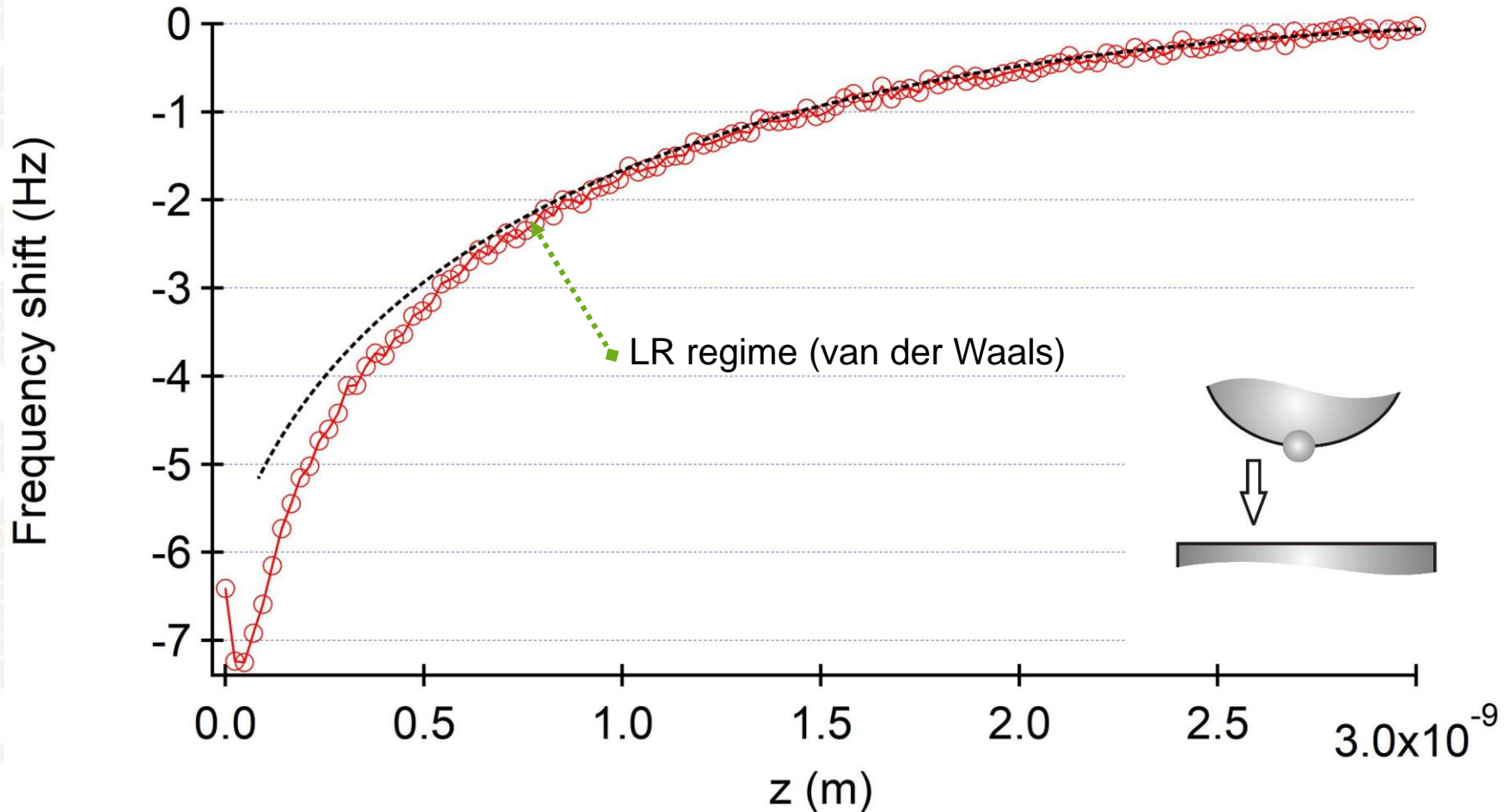

E3- Experimental illustrations

- Δf as a function of the tip-surface distance measured on Cu(111) surface (QTF, $A_0 = 50$ pm, $f_0 = 23$ kHz, $Q = 40000$, $k = 1800$ N/m) :

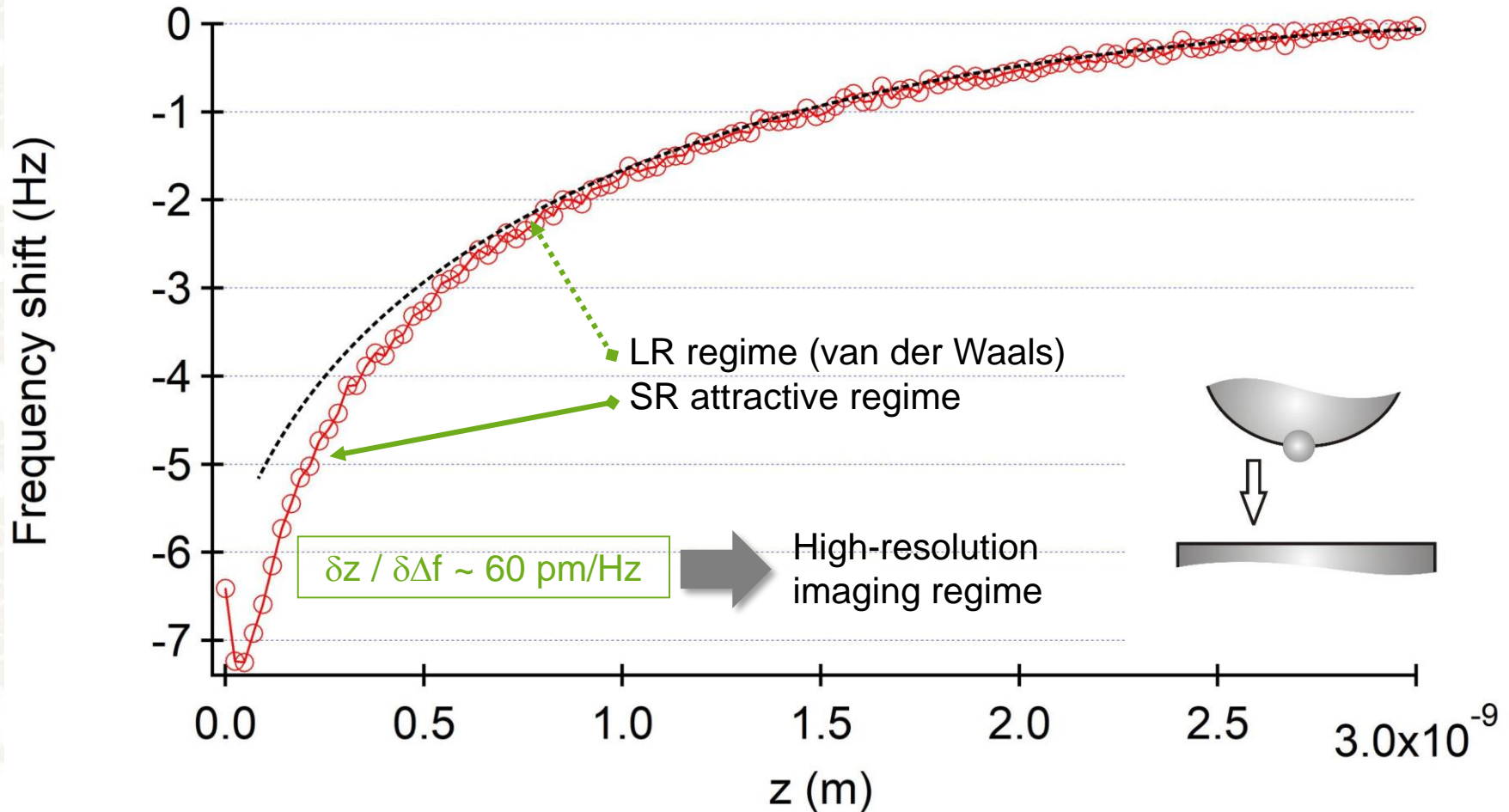

E3- Experimental illustrations

- Δf as a function of the tip-surface distance measured on Cu(111) surface (QTF, $A_0 = 50$ pm, $f_0 = 23$ kHz, $Q = 40000$, $k = 1800$ N/m) :

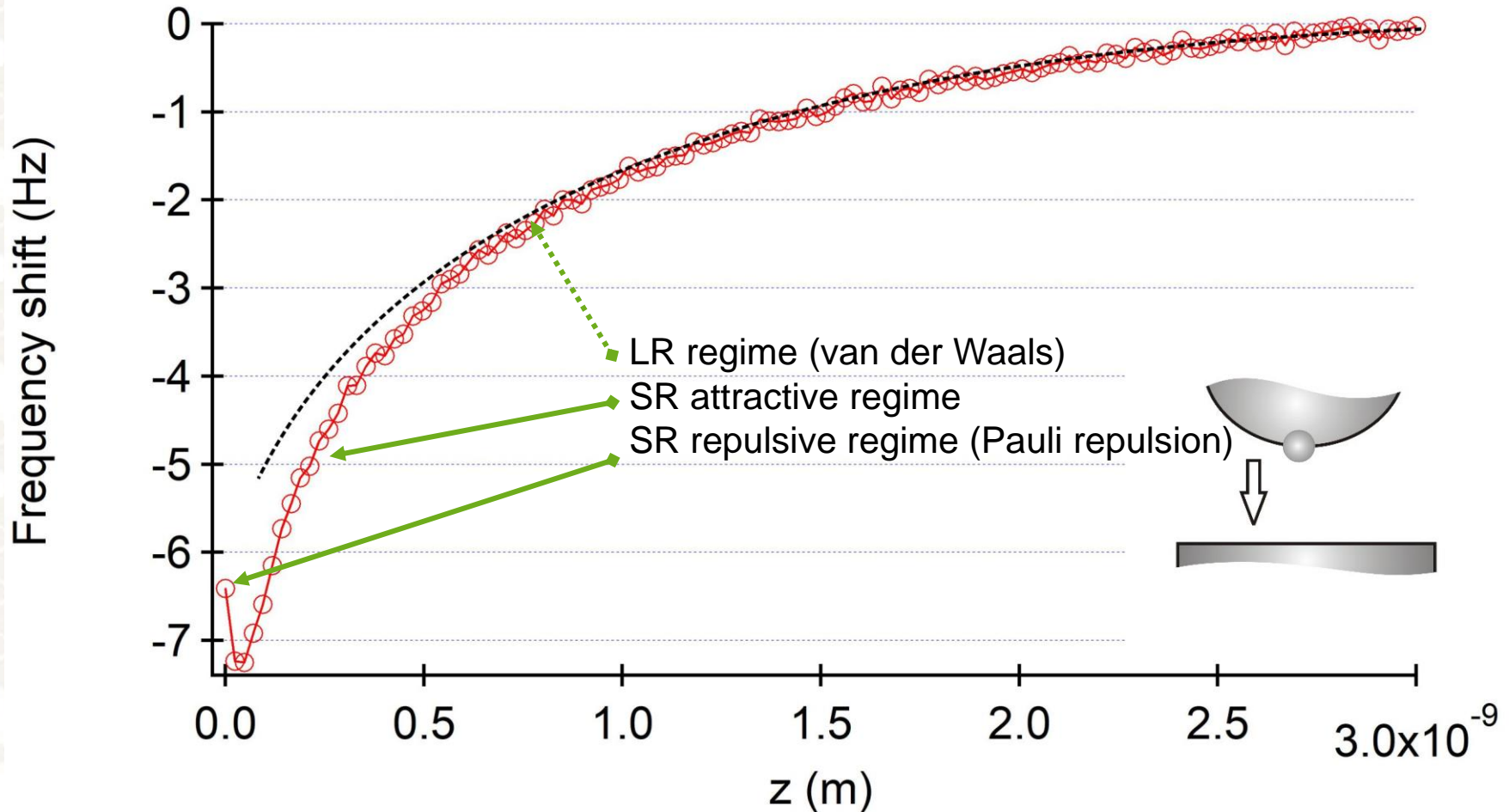

E3- Experimental illustrations

- Back to basics...

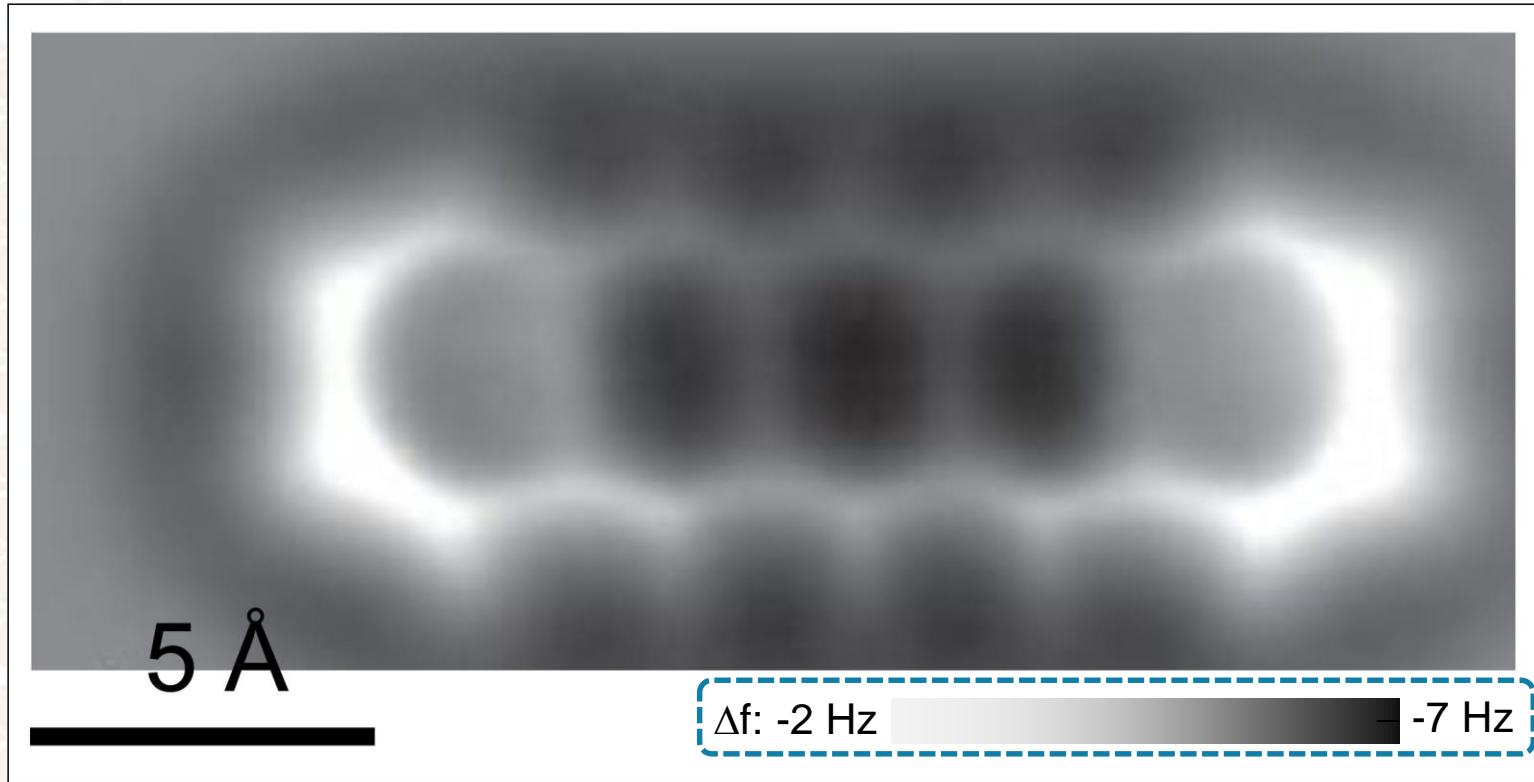

« The chemical structure of a molecule resolved by atomic force microscopy »
L. Gross *et al.*, Science **325**, 1110 (2009)

E3- Experimental illustrations

- Back to basics...

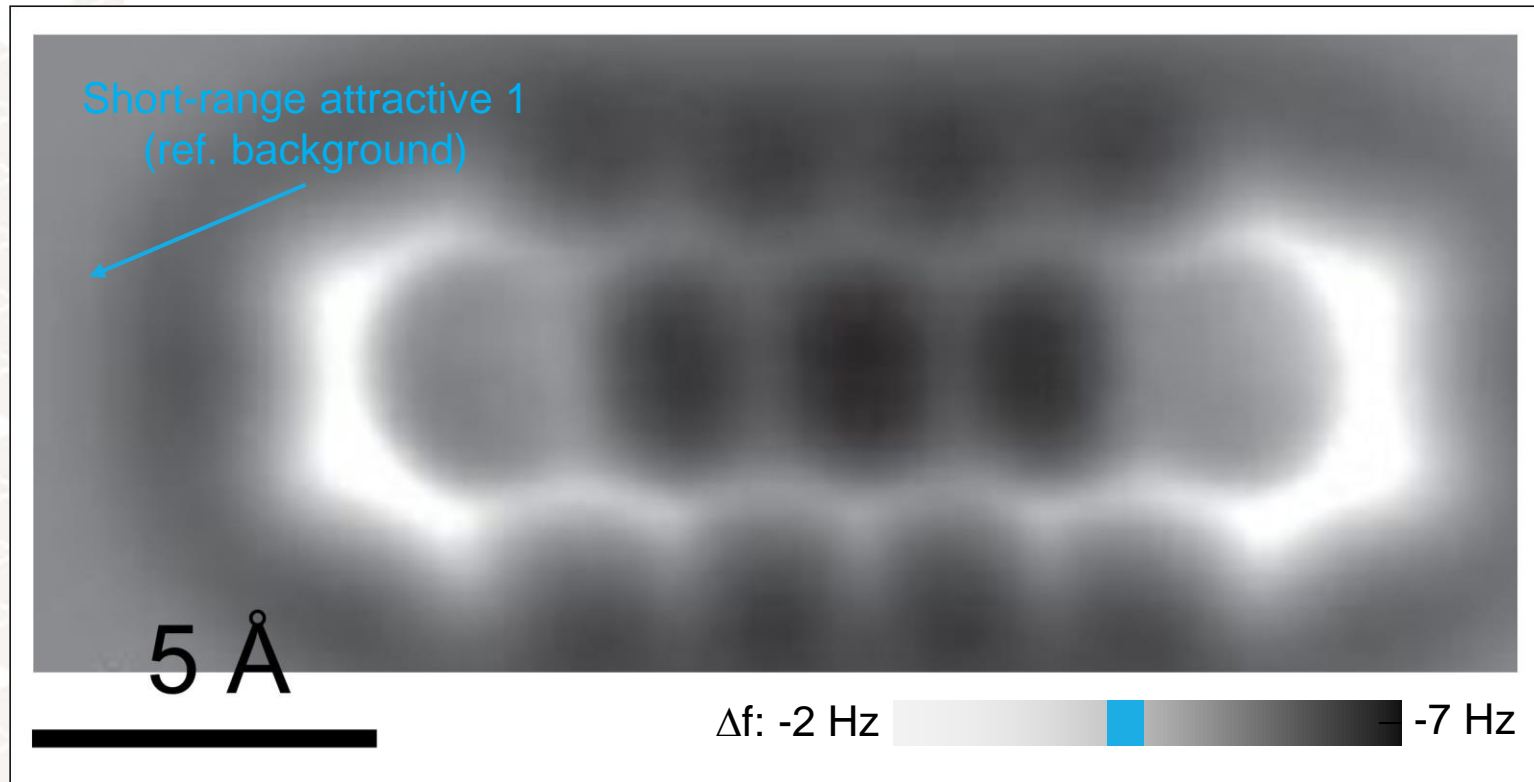

« The chemical structure of a molecule resolved by atomic force microscopy »
L. Gross *et al.*, *Science* **325**, 1110 (2009)

E3- Experimental illustrations

- Back to basics...

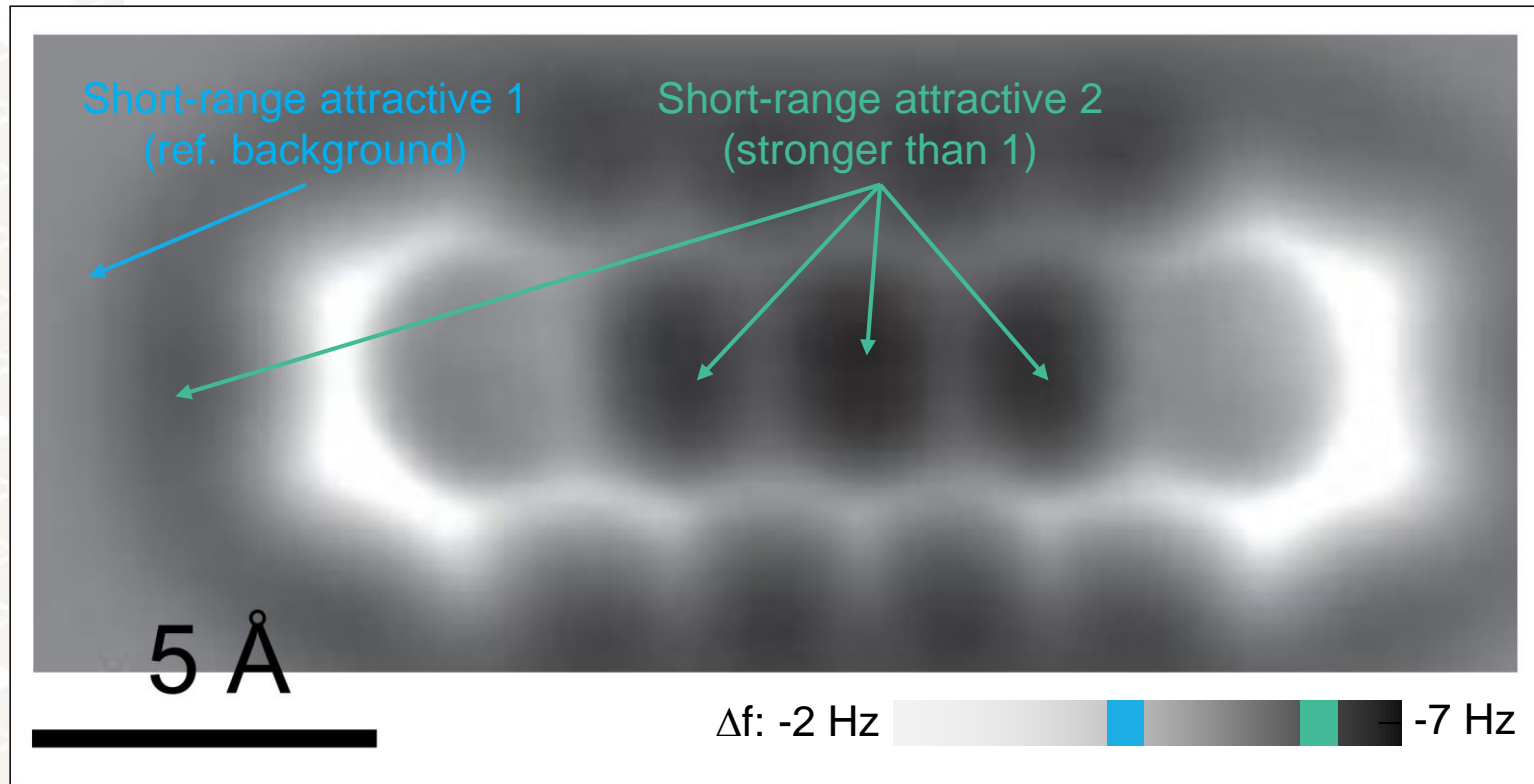

« The chemical structure of a molecule resolved by atomic force microscopy »
L. Gross *et al.*, *Science* **325**, 1110 (2009)

E3- Experimental illustrations

- Back to basics...

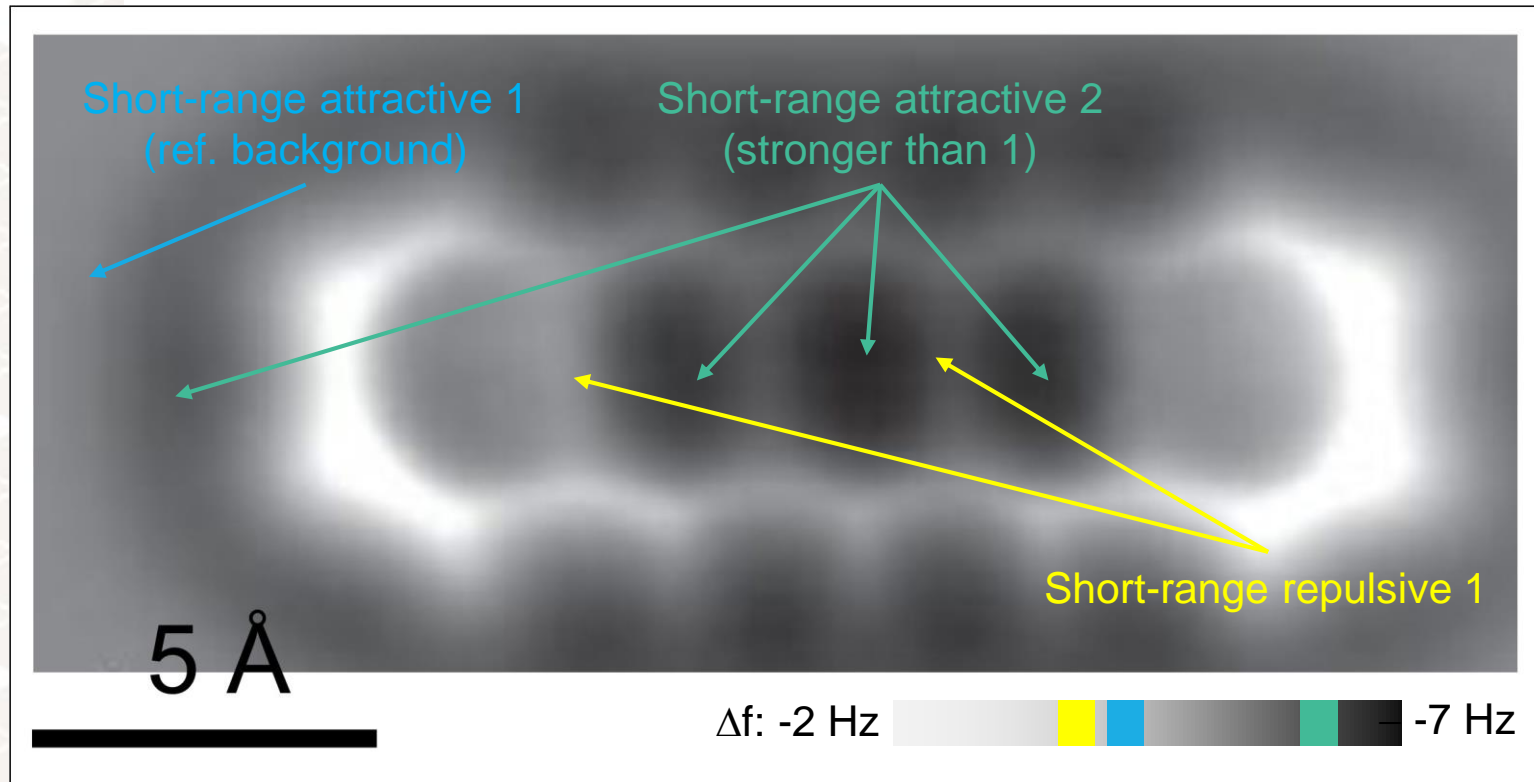

« The chemical structure of a molecule resolved by atomic force microscopy »
 L. Gross *et al.*, Science **325**, 1110 (2009)

E3- Experimental illustrations

- Back to basics...

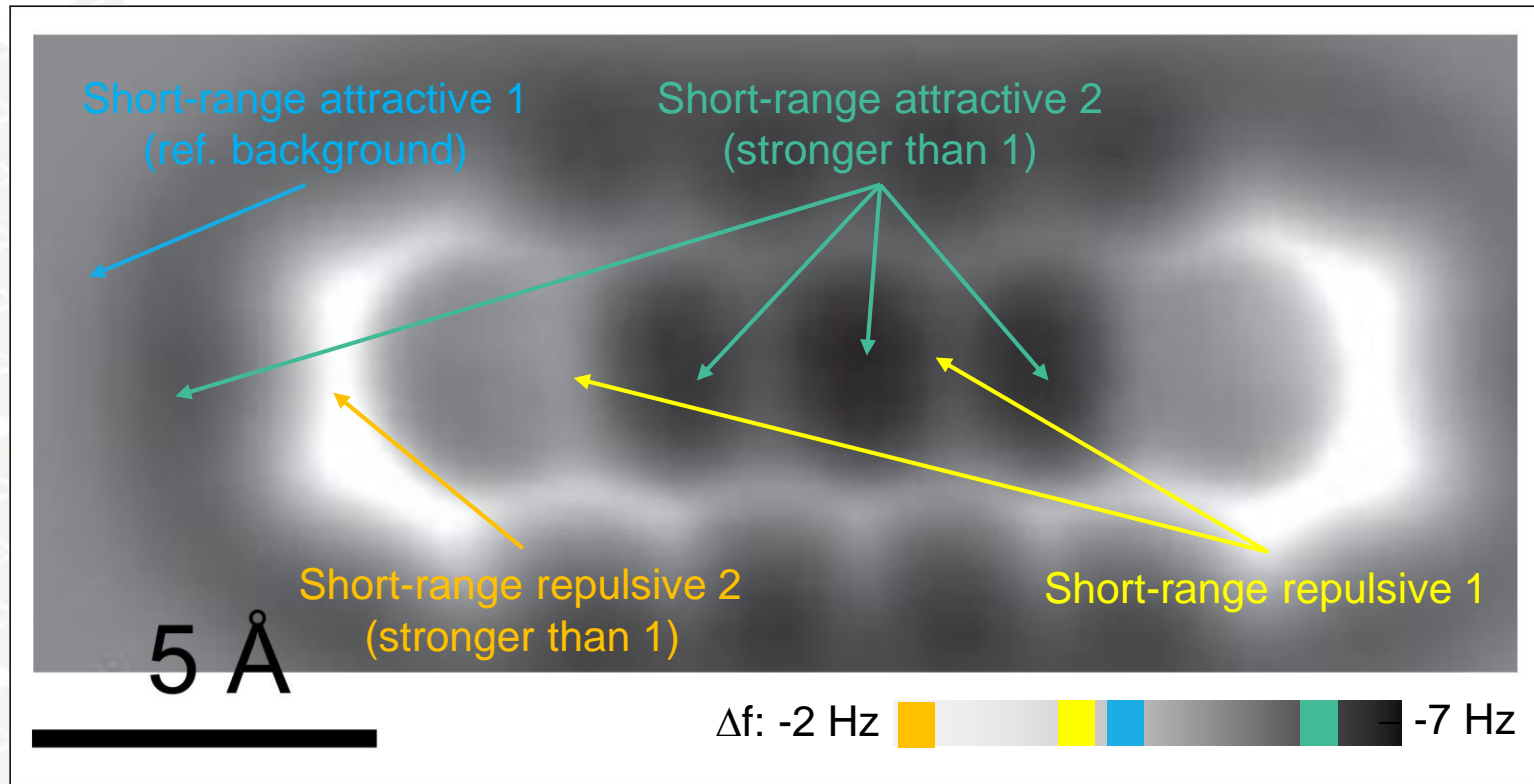

« The chemical structure of a molecule resolved by atomic force microscopy »
 L. Gross et al., Science **325**, 1110 (2009)

E – Non-contact AFM

1. Concept
2. Connection with the modelization
3. Experimental illustrations
- 4. Instrumentation: PLL & amplitude regulation**
5. Main worldwide nc-AFM groups (experimental)



E4- Instrumentation : PLL & amplitude feedback

- Question : how is Δf experimentally detected / what instrumentation ?
- Answer : a Phase Locked Loop (PLL) is used:
 - The PLL ensures the detection of Δf w.r.t. a reference frequency which is fixed equal to the **resonance frequency of the free cantilever f_0** , therefore matching the phase condition $\varphi = -\pi/2$

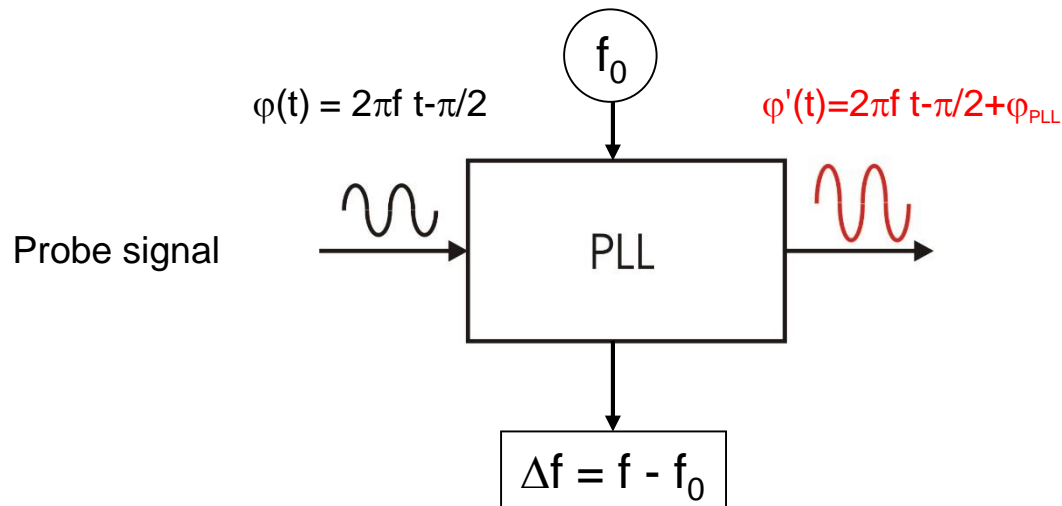

- **Non-contact AFM = Frequency demodulation around f_0 !**



E4- Instrumentation : PLL & amplitude feedback

- Principle for the retention of the excitation at resonance (no interaction):

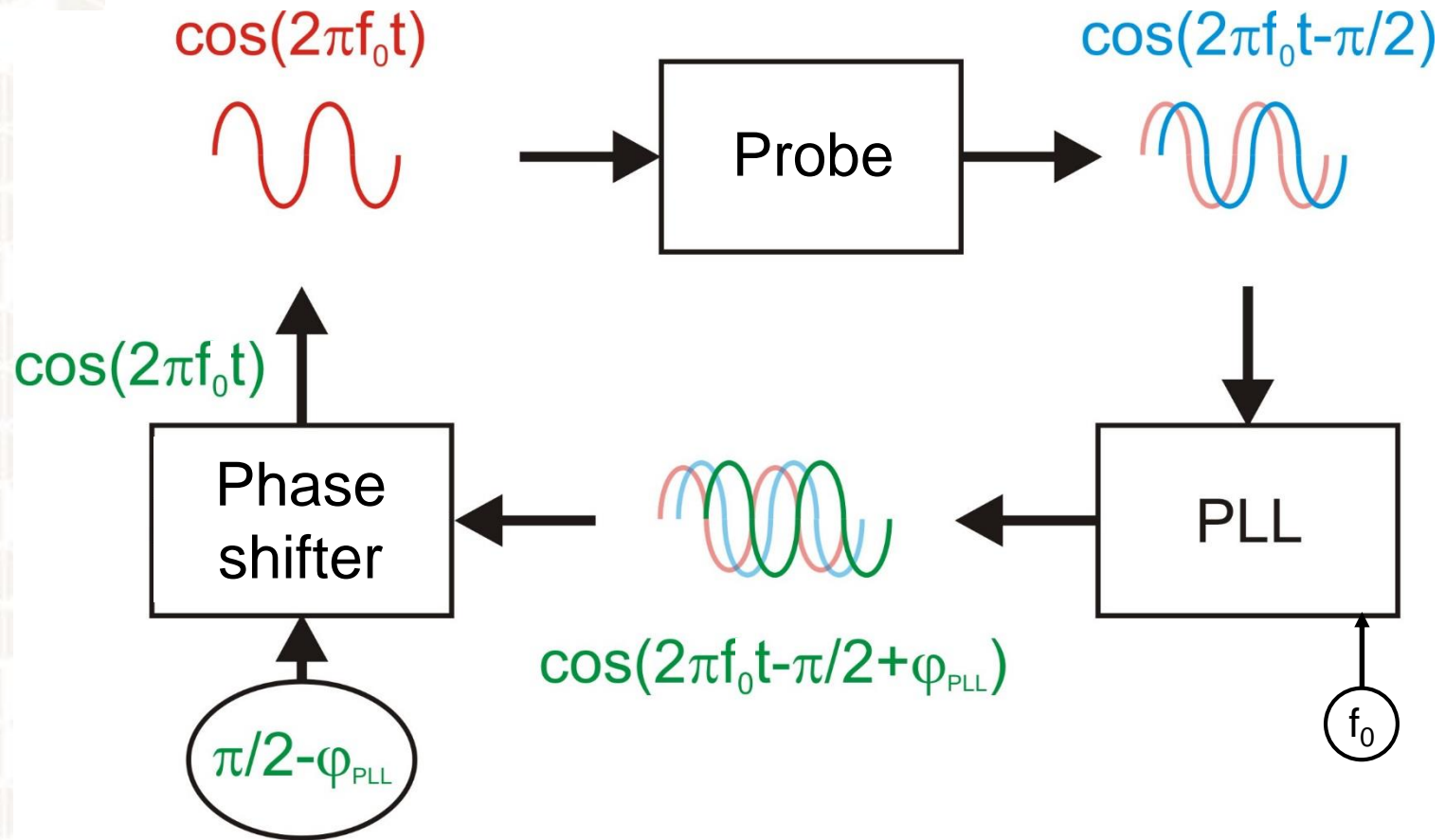



E4- Instrumentation : PLL & amplitude feedback

- Principle for the retention of the excitation at resonance (no interaction):

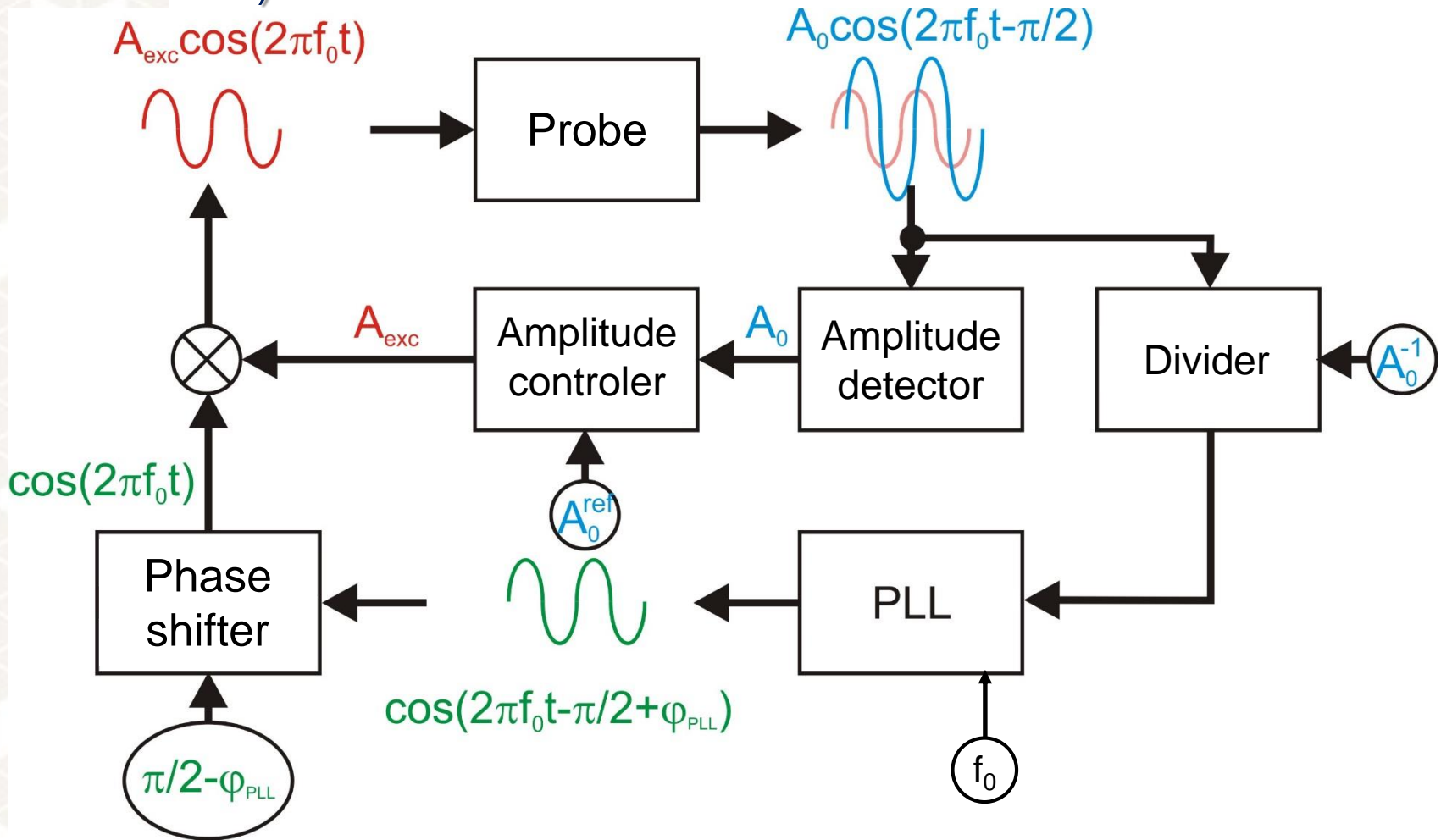



E4- Instrumentation : PLL & amplitude feedback

- Principle for the retention of the excitation at resonance (with interaction $f_0 \rightarrow \tilde{f}_0$):

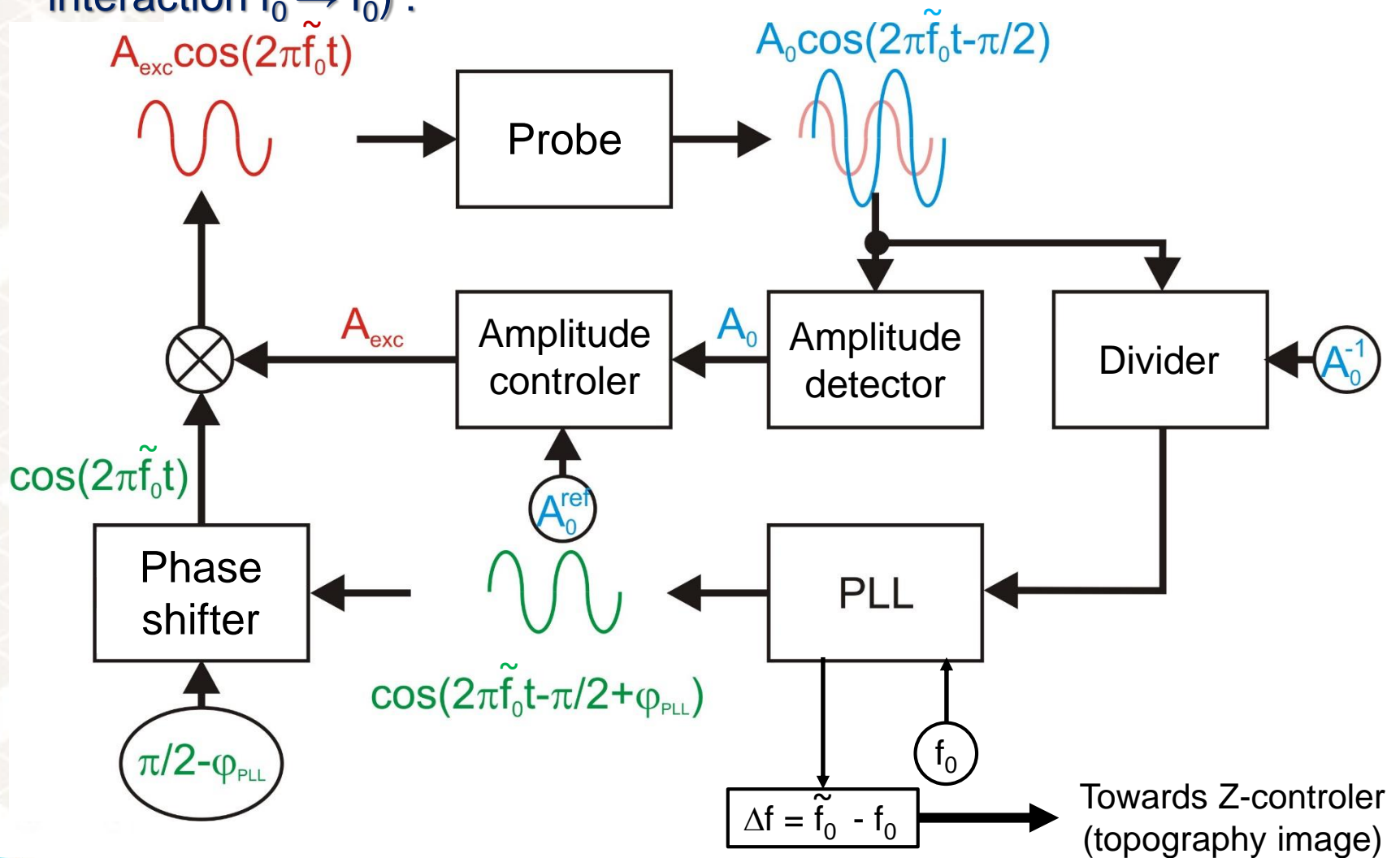



Reference / review papers & books

- “Fast digital electronics for application in dynamic force microscopy using high-Q cantilevers”

Ch. Loppacher *et al.*, Appl. Phys. A **66**, 215 (1998)

- “Noncontact atomic force microscopy simulator with phase-locked-loop controlled frequency detection and excitation”

L. Nony *et al.*, Phys. Rev. B **74**, 235439 (2006)

E – Non-contact AFM

1. Concept
2. Connection with the modelization
3. Experimental illustrations: back to basics
4. Instrumentation: PLL & amplitude regulation
5. **Main worldwide nc-AFM groups (experimental)**

E5 - Main worldwide nc-AFM groups (exp.)

M. Reichling
/ **P. Rahe**
Univ. Osnabrück,
Osnabrück, Germany

R. Wiesendanger,
A. Schwarz
Univ. Hamburg,
Hamburg, Germany

P. Liljeroth
Aalto University
Aalto, Finland

K. Franke
Freie Univ. Berlin
Berlin, Germany

C. Loppacher
/ **C. Barth**
IM2NP / CINaM
Marseille, France

F. Giessibl
/ **J. Repp**
Univ. Regensburg,
Regensburg, Germany

M. Crommie
Univ of California,
Berkeley
San Francisco, USA

B. Grévin
CNRS-CEA
Grenoble, France

Y. Jiang, G. Zhang
Peking University
Beijing, China

U. Schwarz
Yale University
Hartford, USA

E. Meyer,
R. Pawlak
Univ. Basel.
Basel, Switzerland

P. Jelinek
Czech Ac. of Sciences
Prague, Czechia

P. Grütter
Mc Gill University
Montréal, Canada

L. Gross, G. Meyer
IBM research Lab.
Zurich, Switzerland

S. Kawai
National Institute for
Materials Science
Tsukuba, Japan

E5 - Main worldwide nc-AFM groups (exp.)

- Ch. Loppacher's group at IM2NP¹ (AMU) : UHV **RT**-SPM setup

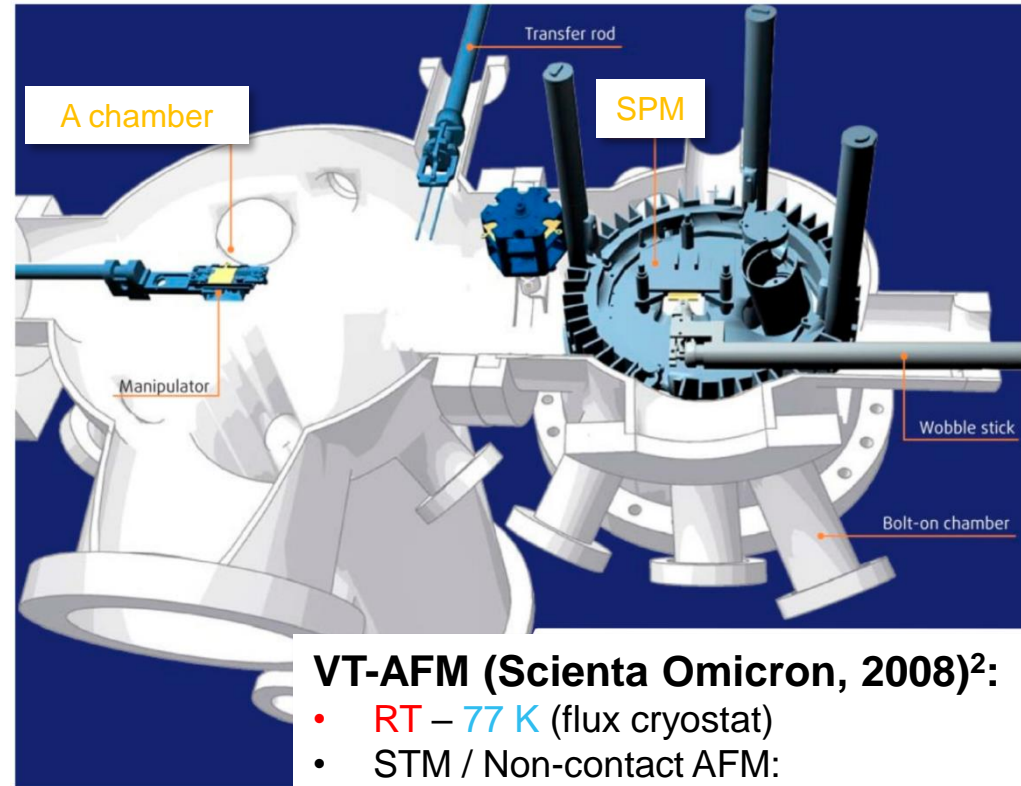
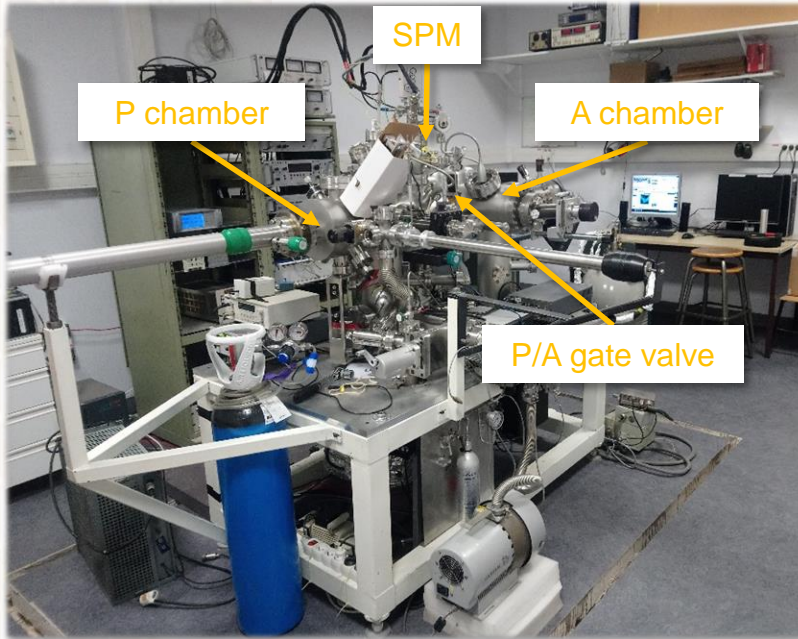

VT-AFM (Scienta Omicron, 2008)²:

- **RT** – **77 K** (flux cryostat)
- STM / Non-contact AFM:
 - Beam deflec. (cantilever)
 - *in situ* 4-quads preamps.
 - $A_{0,min} \sim 2 \text{ \AA}$
 - Mean Z (topo.) noise $\sim 10 \text{ pm}$
 - RHK Rev9 control unit

¹ <https://www.im2np.fr/fr/equipe-nanostructuration-nano>

² DOI: [10.13140/RG.2.2.28075.39200](https://doi.org/10.13140/RG.2.2.28075.39200)

E5 - Main worldwide nc-AFM groups (exp.)

- Ch. Loppacher's group at IM2NP¹ (AMU) : UHV RT-SPM setup

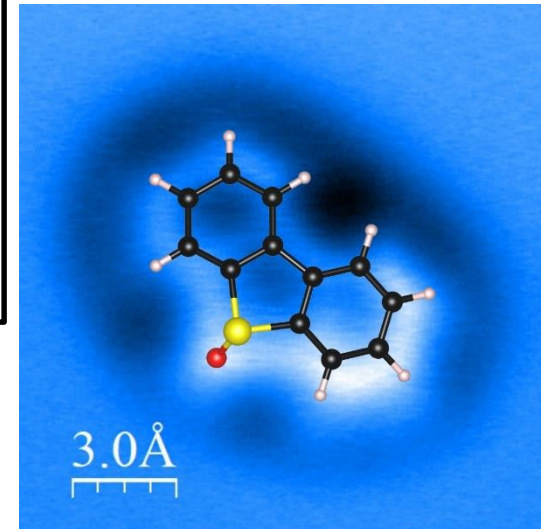
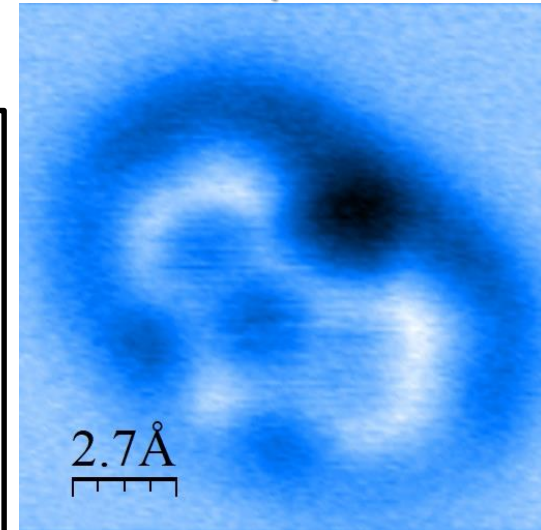
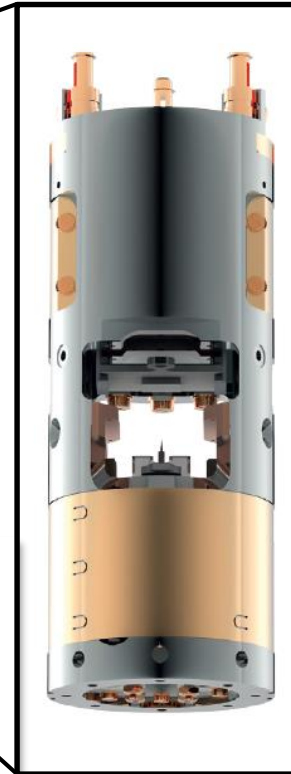
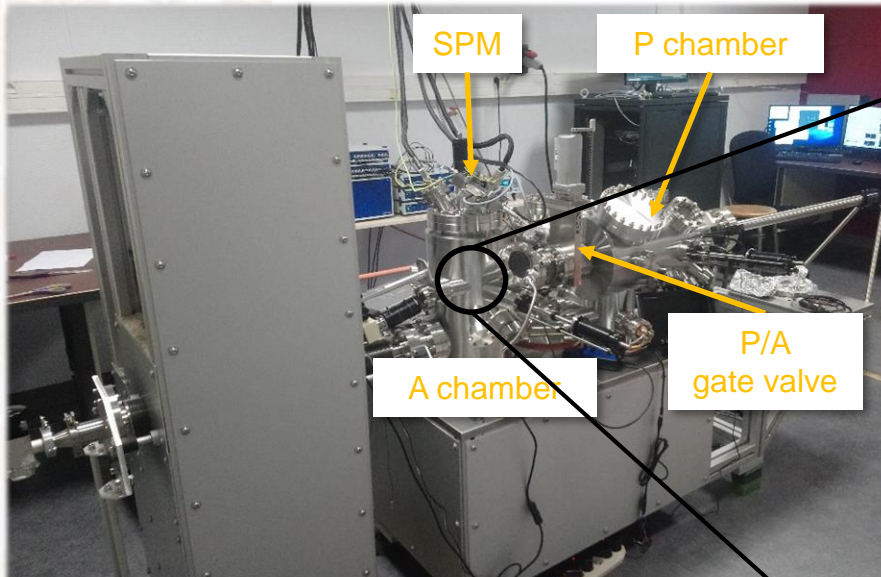

LT-SPM Infinity (Σ Surface Science, Dec.2019)²:

- 8.7 K (cryo-free closed cycle, pulse tube cooler)
- STM / nc-AFM:
 - Quartz tuning fork
 - $A_{0,\min} \sim 10$ pm
 - Mean Z (topo.) noise ~ 1 pm
 - SPECS MIMEA control unit

¹ <https://www.im2np.fr/fr/equipe-nanostructuration-nano>

² a poster is available upon reasonable request

Non contact-AFM : summary

- Demodulation technic of the frequency of the probe when it oscillates close to the surface (\tilde{f}_0) around a central frequency which is the resonance frequency of the free probe (f_0), which forms the so-called frequency shift signal :

$$\Delta f = \tilde{f}_0 - f_0$$

- The oscillation amplitude (A_0) and the phase ($\varphi = -\pi/2$) are kept constant : resonance values
- True non-contact method :
 - Attractive interaction regime with the surface
 - $\Delta f < 0$
- Very large z sensitivity in the short-range interaction regime upon accurate detection of Δf , which allows for large vertical and lateral contrasts (atomic / sub-molecular resolution)

A last (but truly not least!) word...

Pentacene, as imaged by non-contact Atomic Force Microscopy (nc-AFM)

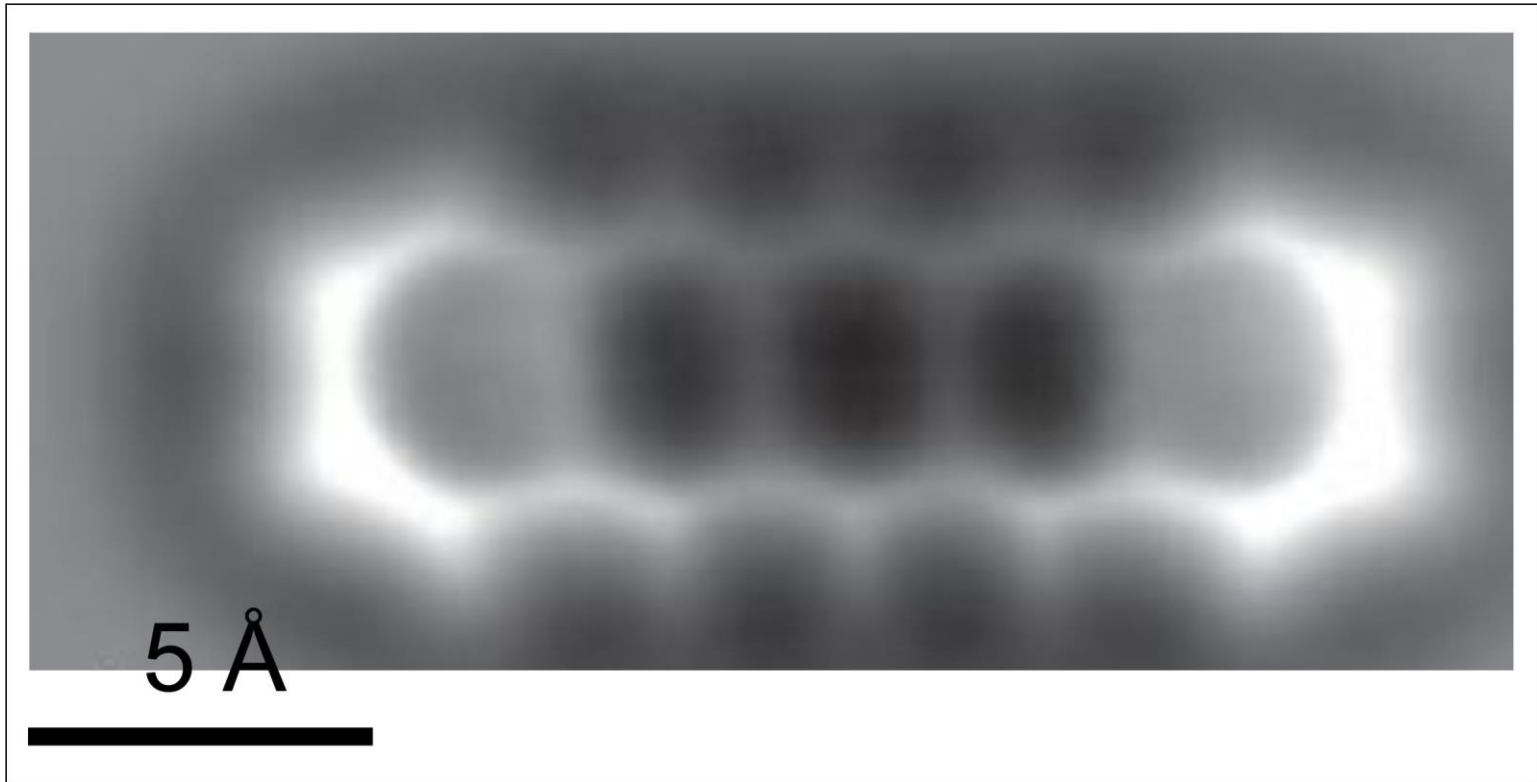

« The chemical structure of a molecule resolved by atomic force microscopy »
L. Gross *et al.*, *Science* **325**, 1110 (2009)

The « trick »: CO tip functionalization

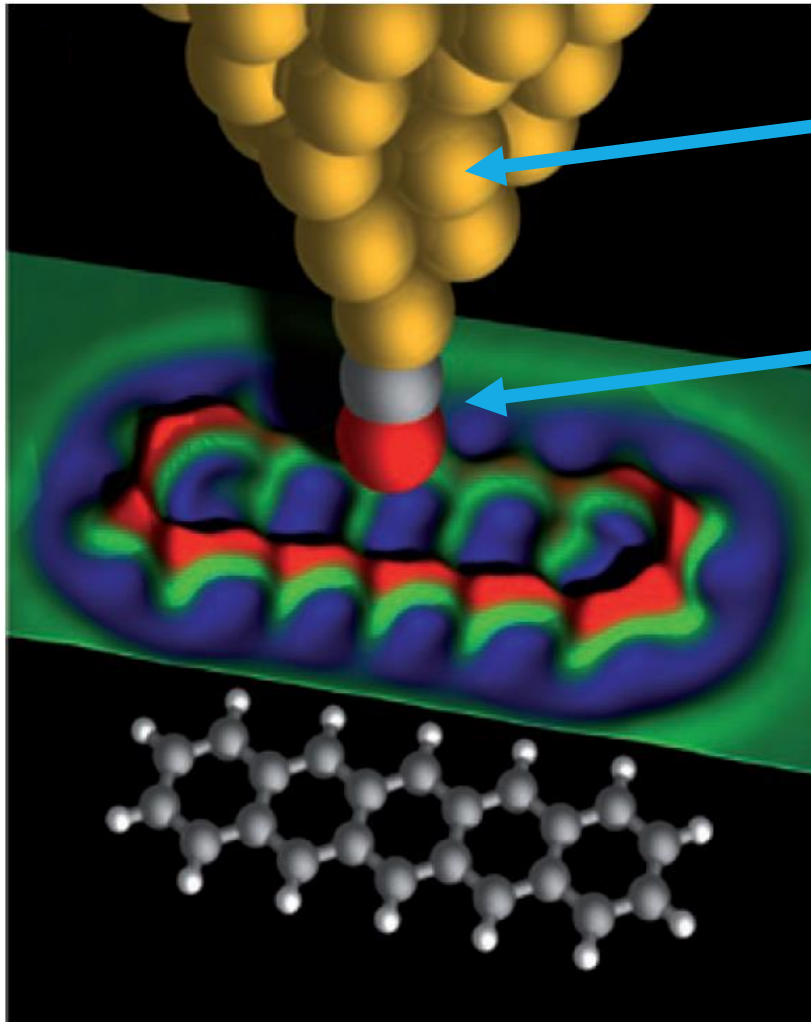

Metallic tip (mostly Cu),
atomically defined

CO molecule

Open question / theme to think about:

"Tracking and sorting interatomic forces down to the fN regime : find recent examples reporting very weak bonds formation and/or transition from physisorption to chemisorption, as measured by non-contact atomic force microscopy."



Institut **M**atériaux **M**icroélectronique **N**anosciences **P**rovence

Thanks for your attention

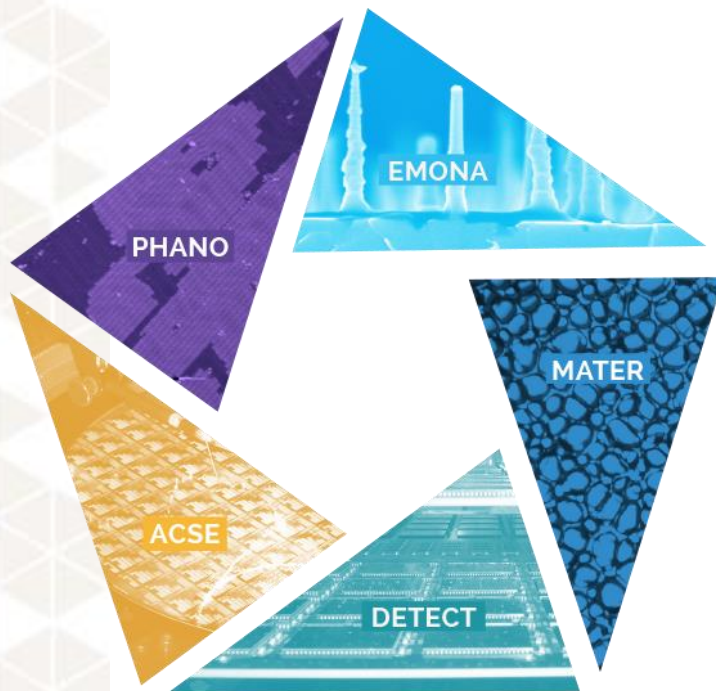

**Relier le fondamental
aux applications
dans nos domaines
d'expertise**

www.im2np.fr

