



HAL
open science

Microscopie de sonde de Kelvin : concepts et applications

Laurent Nony

► **To cite this version:**

Laurent Nony. Microscopie de sonde de Kelvin : concepts et applications. Doctoral. 24ème Forum des microscopies à sonde locale, Obernai, France. 2023, pp.140. hal-04068415

HAL Id: hal-04068415

<https://cnrs.hal.science/hal-04068415>

Submitted on 13 Apr 2023

HAL is a multi-disciplinary open access archive for the deposit and dissemination of scientific research documents, whether they are published or not. The documents may come from teaching and research institutions in France or abroad, or from public or private research centers.

L'archive ouverte pluridisciplinaire **HAL**, est destinée au dépôt et à la diffusion de documents scientifiques de niveau recherche, publiés ou non, émanant des établissements d'enseignement et de recherche français ou étrangers, des laboratoires publics ou privés.

MICROSCOPIE DE SONDE DE KELVIN: CONCEPTS ET APPLICATIONS

Laurent NONY

Aix-Marseille Université, IM2NP, UMR CNRS 7334
Marseille, France

laurent.nony@im2np.fr

24^{ème} Forum des microscopies à sonde locale
Obernai, 3-7 Avril 2023, France



Institut Matériaux Microélectronique
Nanosciences de Provence



Aix-Marseille
université
Initiative d'excellence

UNIVERSITÉ
DE TOULON

ISEN
ALL IS DIGITAL!
MEDITERRANÉE



Association
INSTITUTS
CARNOT

Motivation

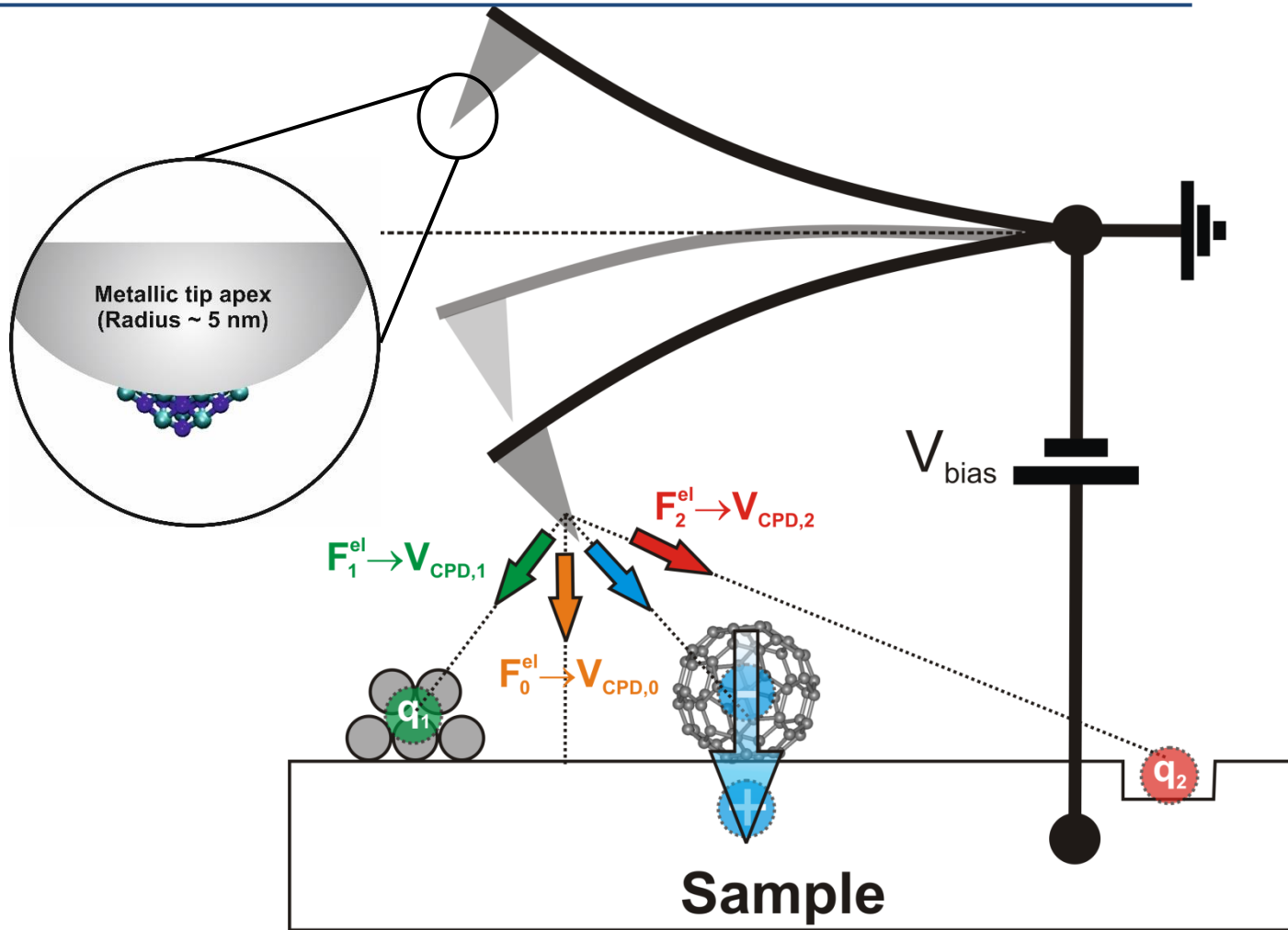

Forces:

- van der Waals
- Chemical
- *Magnetostatic*
- **Electrostatic**

Electrostatic contribution potentially detrimental
for AFM resolution → compensation

AFM zoology



AFM zoology

— Electric modes

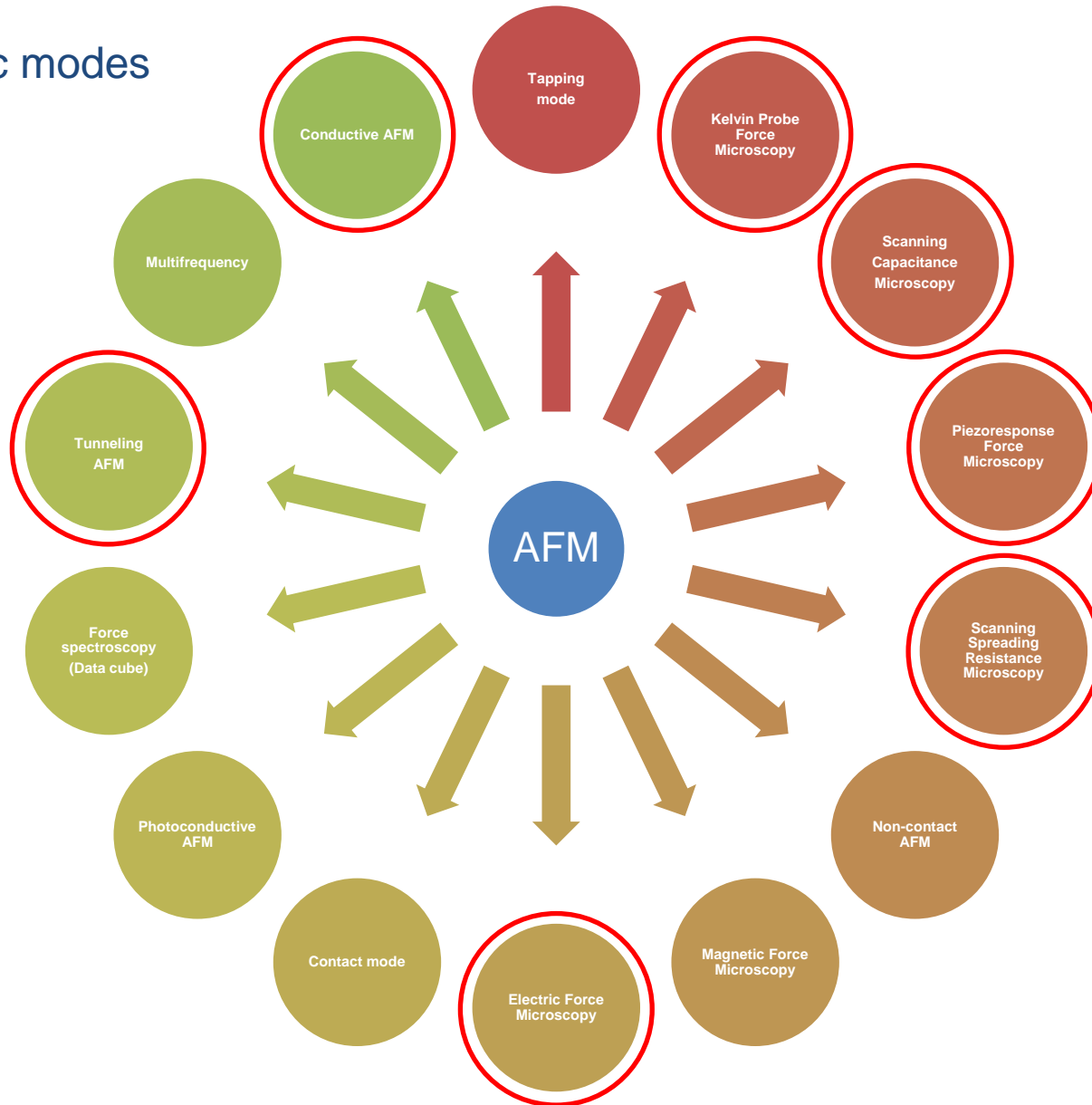

AFM zoology

— Electric modes
— Dynamic modes

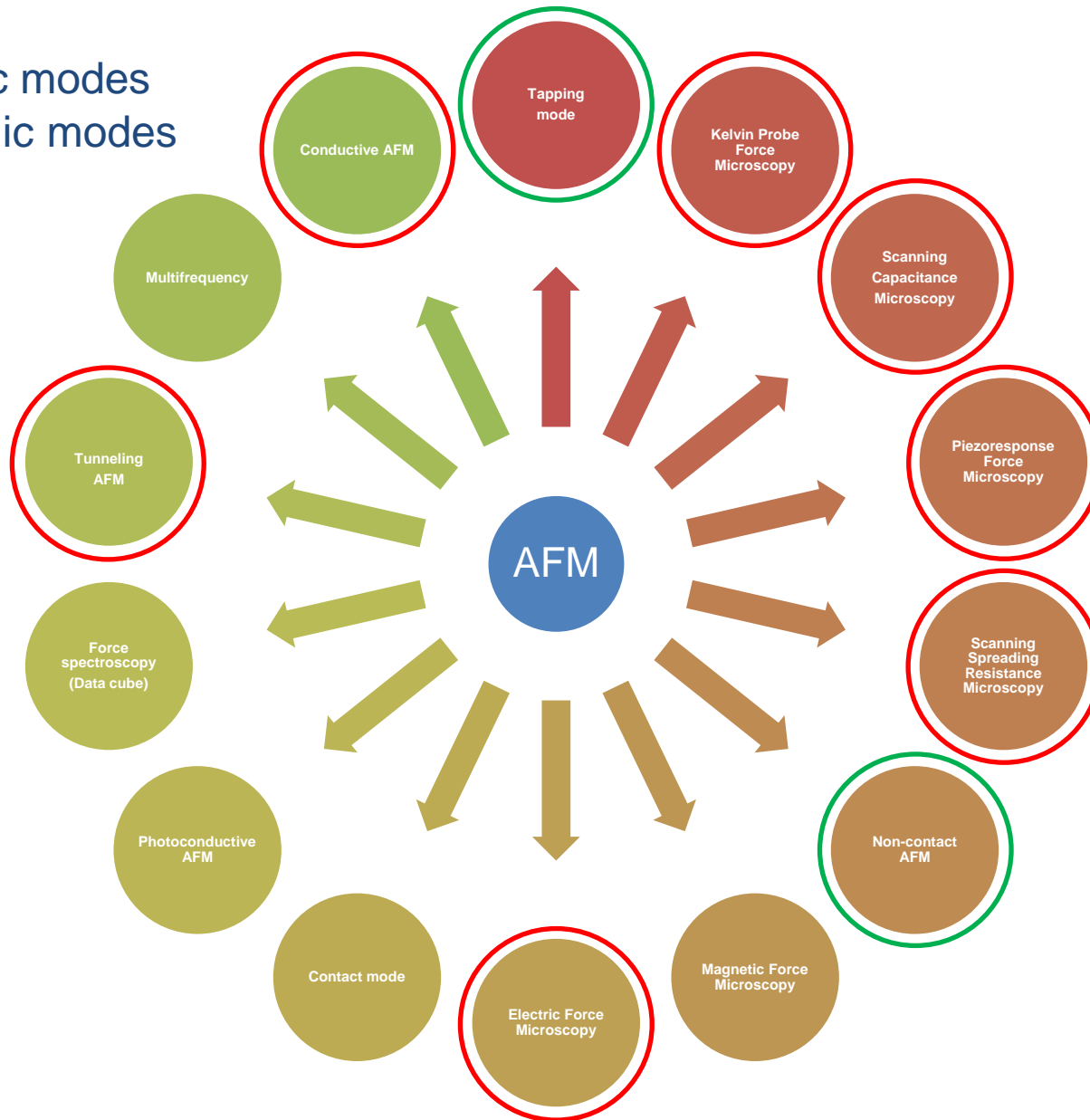

AFM zoology

- Electric modes
- Dynamic modes
- Concepts

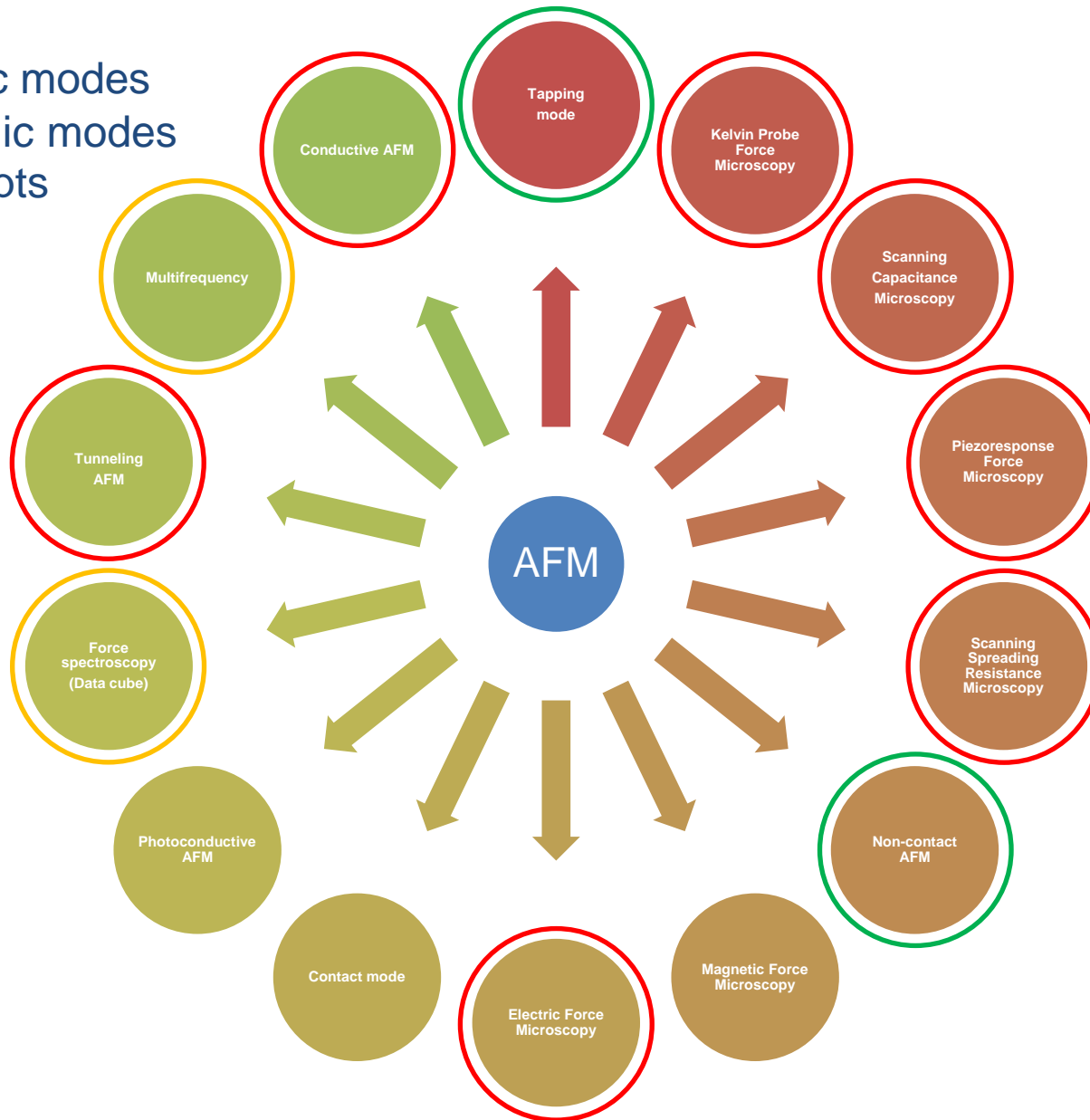

AFM zoology

- Electric modes
- Dynamic modes
- Concepts

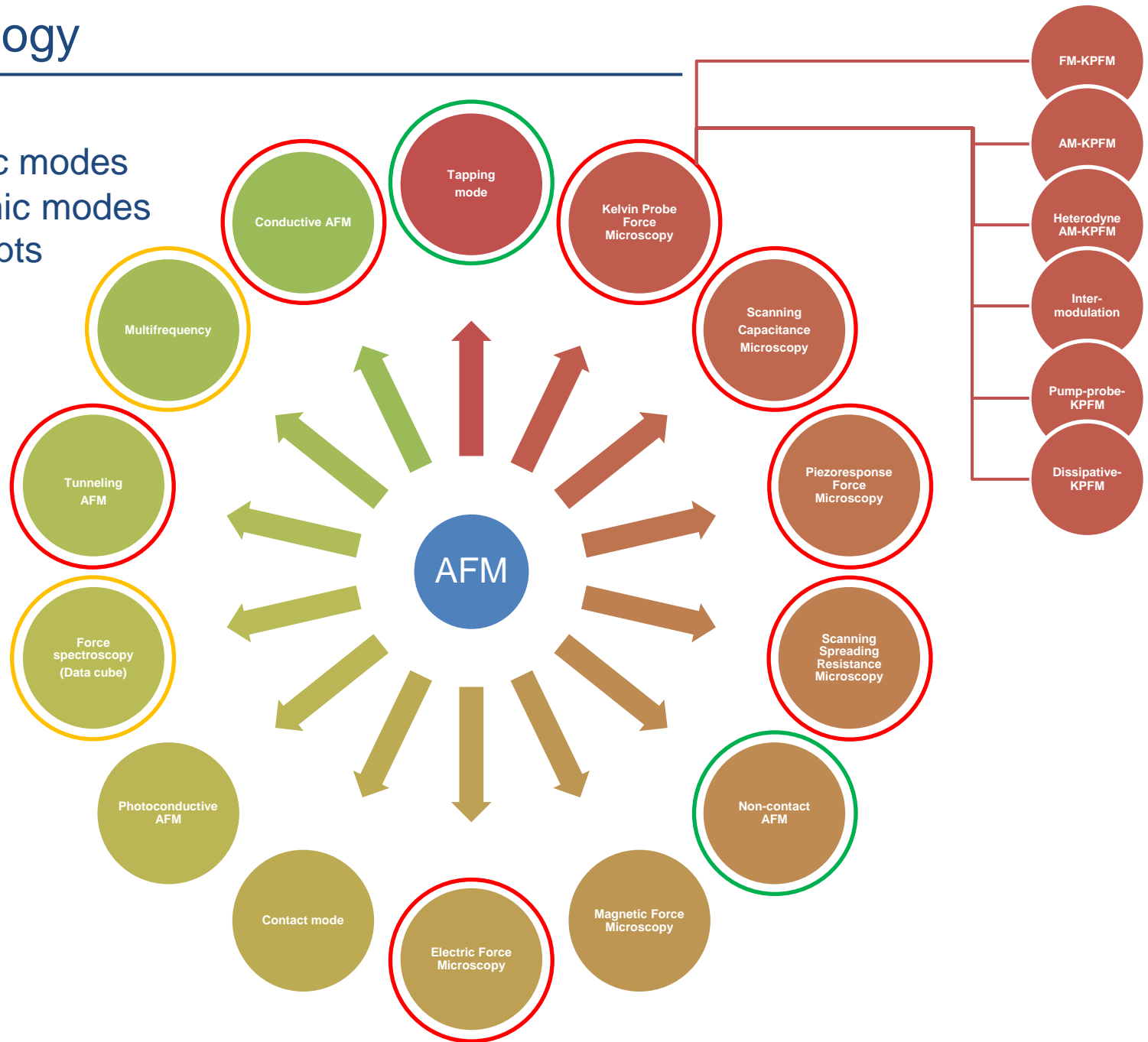

TINTIN

et LES FORCES OBSCURES

*Rêve, voyance, hypnose,
radiesthésie, télépathie,
extraterrestres, superstitions,
sociétés secrètes, folie...*

Historia

A black and white illustration of Tintin and a man in a dark coat. Tintin is on the right, wearing his signature blue shirt and red trousers, with his hands raised to his face in a gesture of shock or fear. The man on the left is wearing a dark coat and a cap with a gold emblem, looking towards Tintin with a serious expression. The background is a dark, swirling tunnel.

The focus of that lecture...

- Electric modes
- Dynamic modes
- Concepts

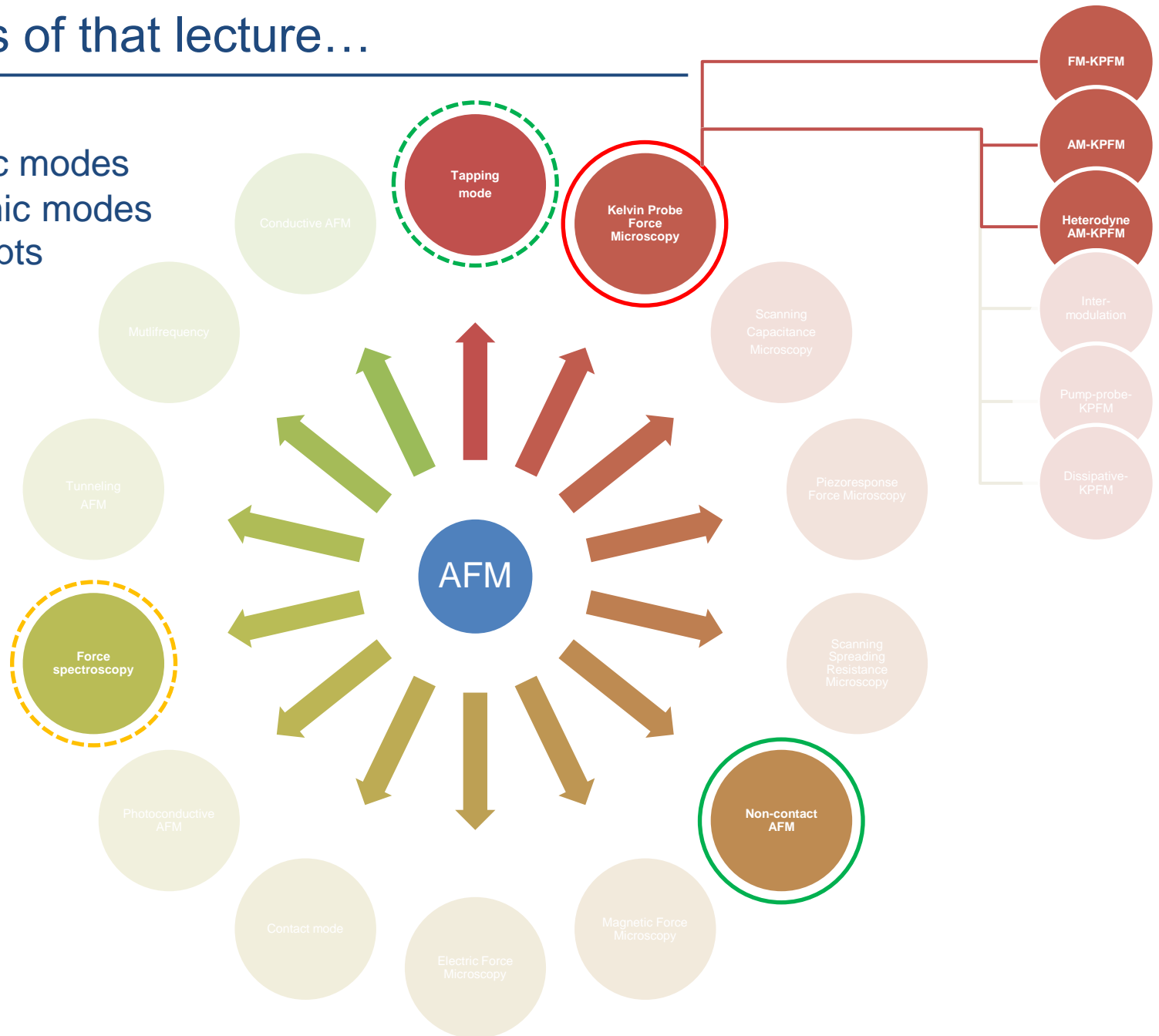

Motivation

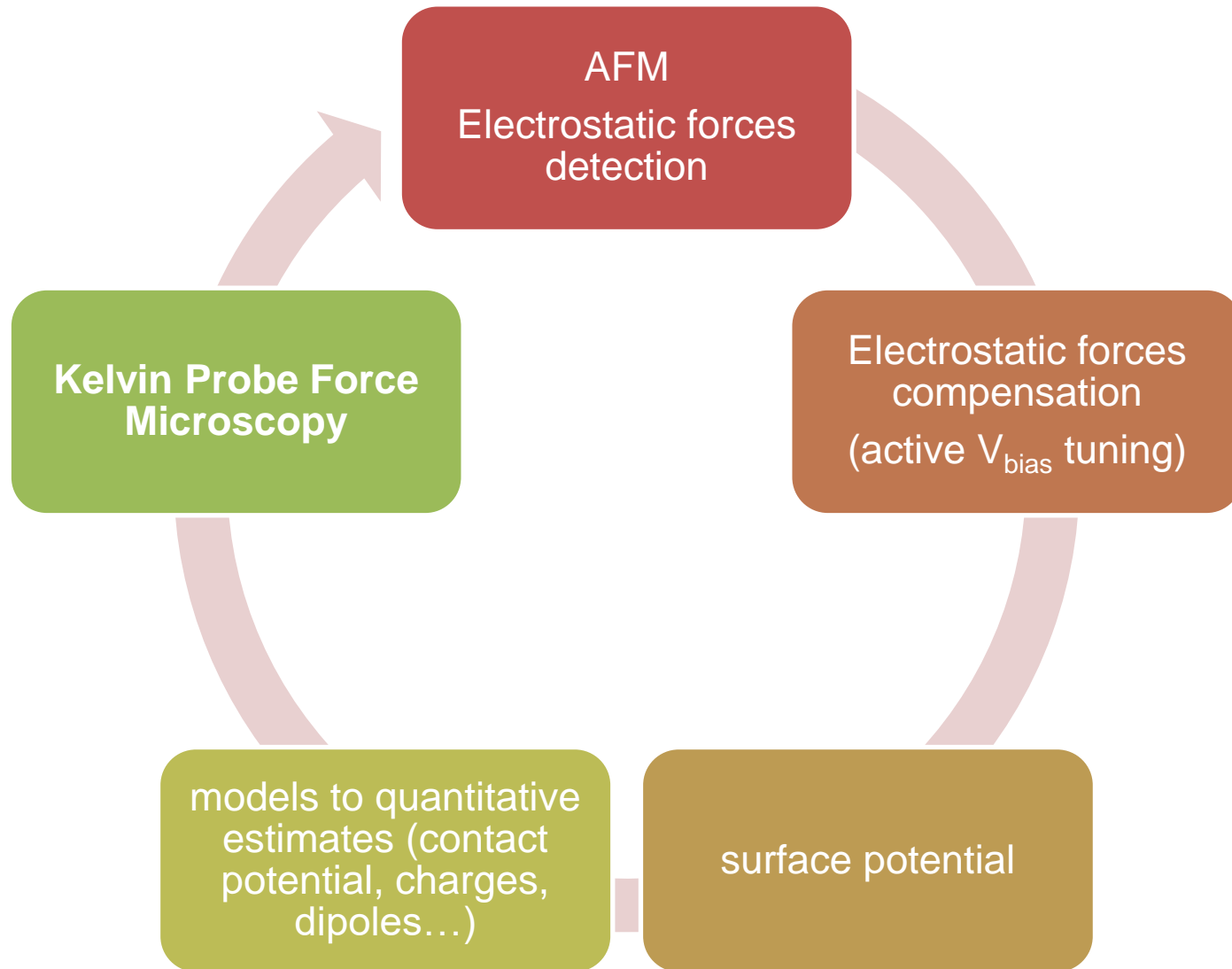

Major references (see also last section...)

☐ Books:

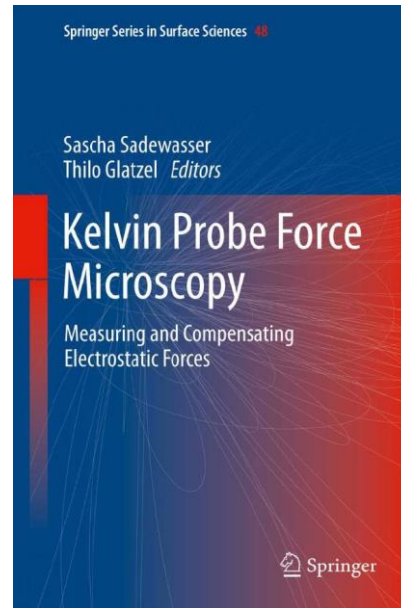

2011

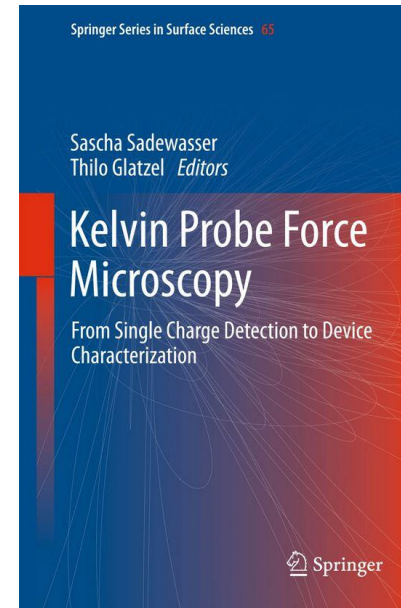

2018



☐ Review article:

- “Kelvin probe force microscopy and its application”, W. Melitz *et al.*, Surf. Sci. Rep. **66** (2011)

☐ Webinars

Before starting...

❑ There will be color...

- ✓ Slides marked with  are to be understood
- ✓ Slides marked with  can conceptually be accepted and be understood later
- ✓ Slides marked with  address more complex concepts. Use the related references to get into them and take your time

❑ Slides including the symbol won't be addressed during that lecture

- ✓ They may contain relevant information for you, though
- ✓ They remain included in the flow of slides as they are thematically relevant

Outline

I. INTRODUCTION to KPFM

II. CONCEPTS & IMPLEMENTATIONS

III. ELECTROSTATIC MODELS



IV. EXAMPLES OF APPLICATIONS



CONCLUSION

Some references...

Outline

I. INTRODUCTION to KPFM

II. CONCEPTS & IMPLEMENTATIONS

III. ELECTROSTATIC MODELS

IV. EXAMPLES OF APPLICATIONS

CONCLUSION

Some references...

I. Introduction to KPFM

Electrostatic force: macroscopic concept

- Parallel-plate capacitor (metallic electrodes) :

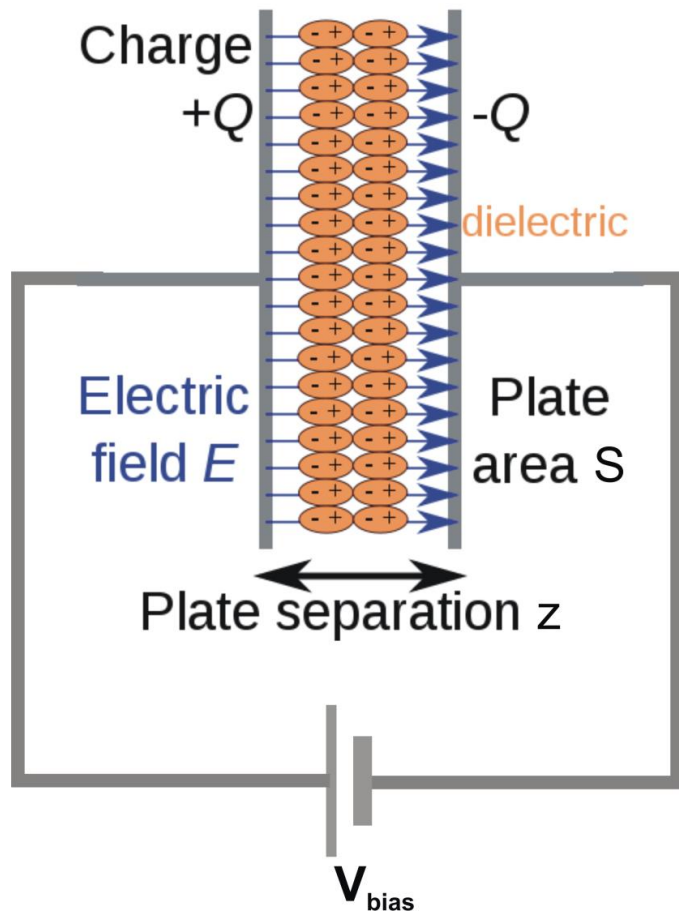

- Capacitance $C(z)$:

$$C(z) = \frac{\epsilon_0 \epsilon_r S}{z} = \frac{Q}{V_{\text{bias}}}$$

(Eq.1)

Electrostatic force: macroscopic concept



William Thomson (later Lord Kelvin of Largs):
1824 (Belfast, Ireland) - 1907 (Largs, UK)

V. *Contact Electricity of Metals.* By Lord KELVIN,
G.C.V.O., D.C.L., LL.D., F.R.S., M.R.I.*

§ 1. **W**ITHOUT preface two 95 years' old experiments of Volta's were, one of them shown, and the other described. The apparatus used consists of: (a) a Volta-condenser of two varnished brass plates, of which the lower plate is insulated in connexion with the gold leaves of a gold-leaf electroscope, and the upper plate is connected by a flexible wire with the sole plate of the instrument; (b) two circular discs, one of copper and the other of zinc, each polished and unvarnished. I hold one in my right hand by a varnished glass stem attached to it, while on my left hand I hold the

* Communicated by the Author, having been read at the meeting of the Royal Institution on May 21st, 1897.

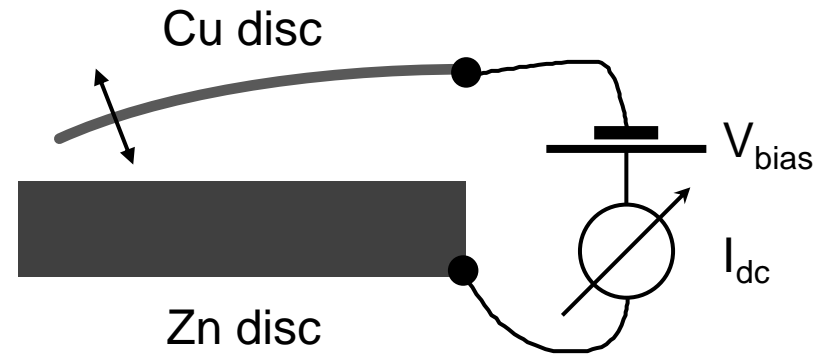

$$I_{dc} = \frac{dC}{dt} (V_{bias} - V_{offs}) \quad (Eq.2)$$

*Lord Kelvin, *Phil. Mag.* Series 5, **46(278)**, 82 (1898)

Electrostatic force: relevance for AFM

- Parallel-plate, empty, capacitor (metallic tip, metallic sample with no inner charges, or dipoles):

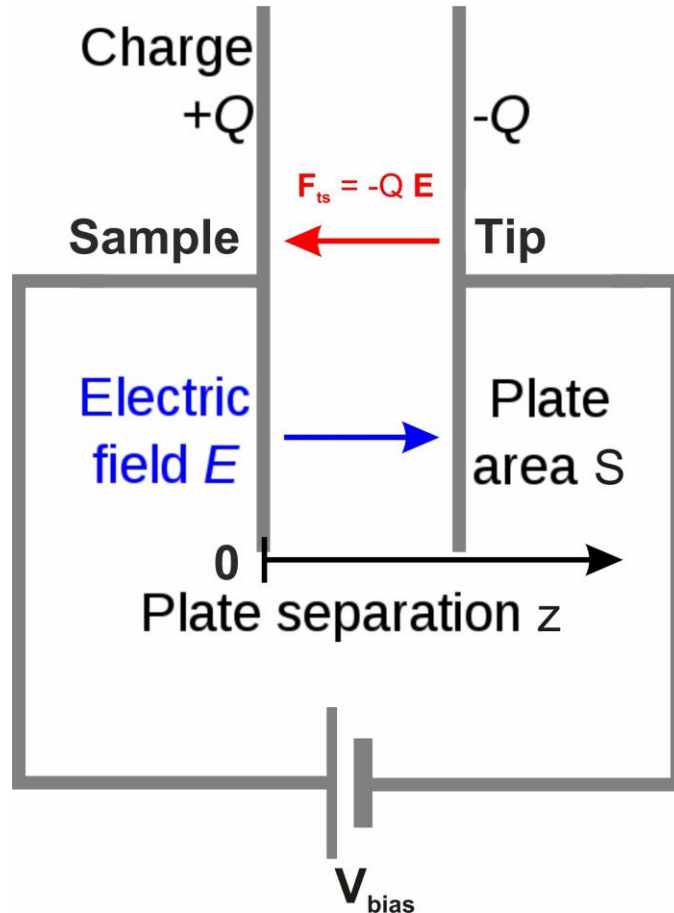

Electrostatic energy :

$$W^{el} = \frac{1}{2} Q V_{bias} = \frac{1}{2} C V_{bias}^2 \quad (Eq.3a)$$

Electrostatic force: relevance for AFM

- Parallel-plate, empty, capacitor (metallic tip, metallic sample with no inner charges, or dipoles):

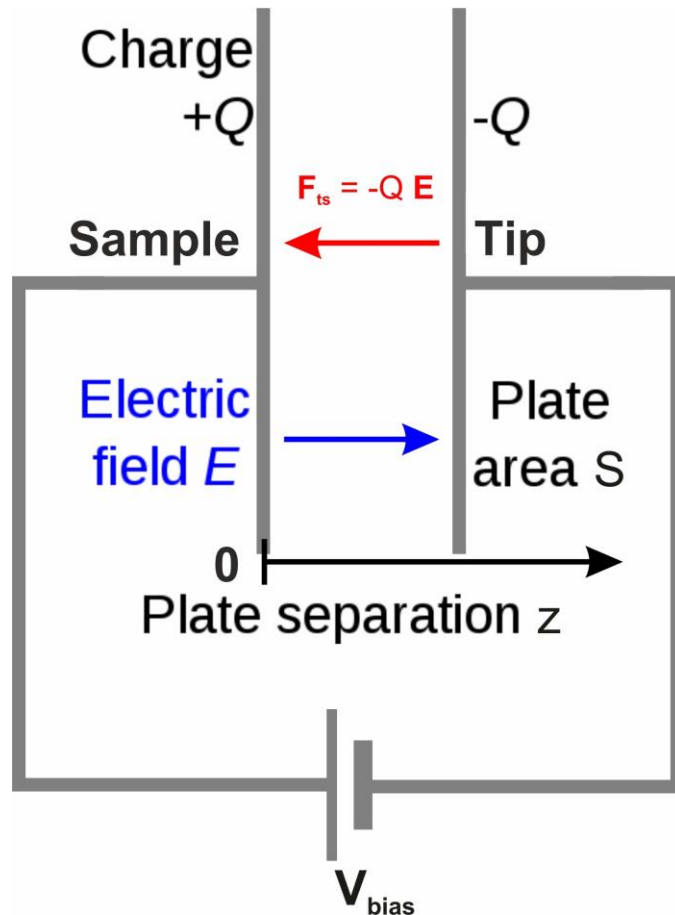

Electrostatic energy :

$$W^{el} = \frac{1}{2} Q V_{bias} = \frac{1}{2} C V_{bias}^2 \quad (Eq.3a)$$

Resulting electrostatic force :

$$\begin{aligned} \mathbf{F}_{tip}^{el} &= \frac{\partial W^{el}}{\partial z} \hat{\mathbf{z}} = \frac{1}{2} \frac{\partial C}{\partial z} V_{bias}^2 \hat{\mathbf{z}} \\ &= -\frac{1}{2} \left| \frac{\partial C}{\partial z} \right| V_{bias}^2 \hat{\mathbf{z}} \quad (Eq.3b) \end{aligned}$$

- **Attractive** (at play in **non-contact regime**)
- **Quadratic dependence on V_{bias}**

Electrostatic force: relevance for AFM

- Parallel-plate, empty, capacitor (metallic tip, metallic sample with no inner charges, or dipoles):

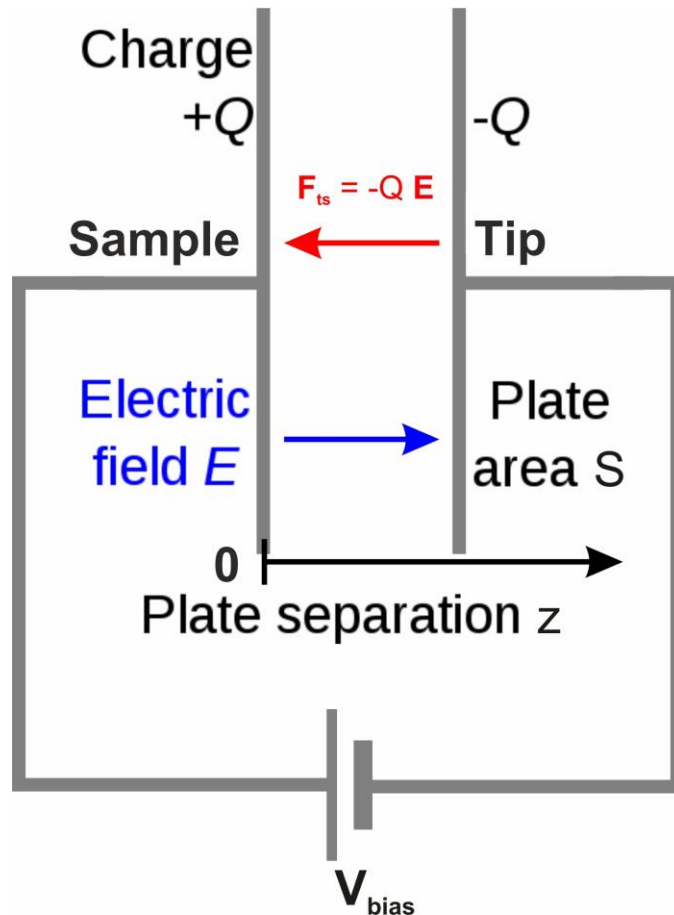

Here:

$$\mathbf{F}_{tip}^{el} = -\frac{1}{2} \frac{\epsilon_0 \epsilon_r S}{z^2} V_{bias}^2 \hat{\mathbf{z}} \quad (Eq.3c)$$

$$\epsilon_r = 1, S = 630 \text{ nm}^2, z \sim 1 \text{ nm}, V_{bias} = 1 \text{ V}$$

↑
Half-sphere $R=10 \text{ nm}$

$$\Rightarrow F^{el} \sim -3 \text{ nN}$$

Electrostatic forces are relevant for AFM!

Electrostatic force: relevance for AFM

- Parallel-plate, empty, capacitor (metallic tip, metallic sample with no inner charges, or dipoles):

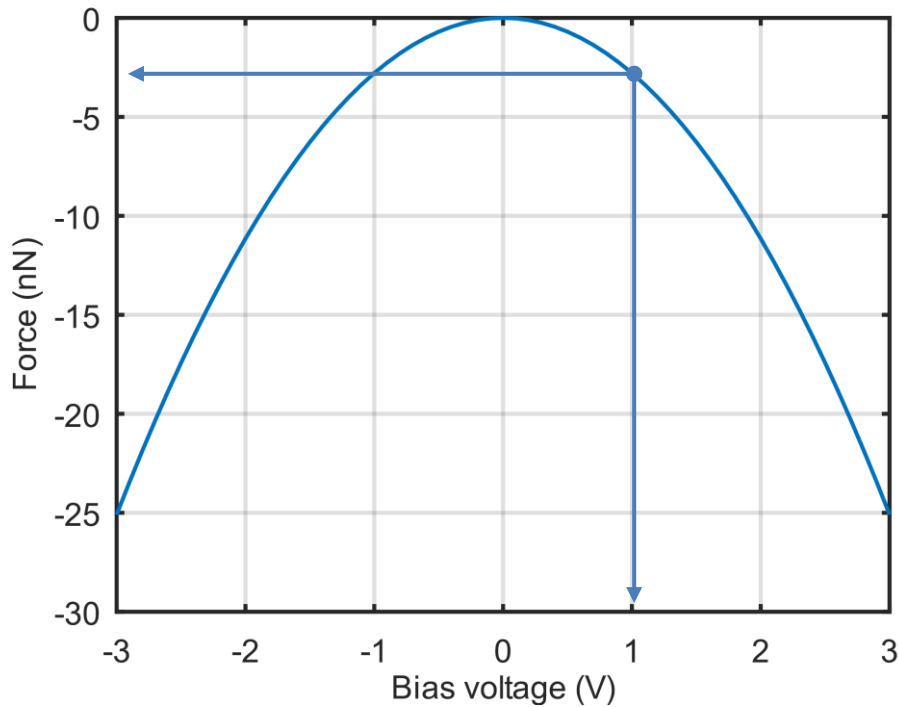

Here:

$$\mathbf{F}_{\text{tip}}^{\text{el}} = -\frac{1}{2} \frac{\epsilon_0 \epsilon_r S}{z^2} V_{\text{bias}}^2 \hat{\mathbf{z}} \quad (\text{Eq.3c})$$

$$\epsilon_r = 1, S = 630 \text{ nm}^2, z \sim 1 \text{ nm}, V_{\text{bias}} = 1 \text{ V}$$

↑
Half-sphere R=10 nm

$$\Rightarrow F^{\text{el}} \sim -3 \text{ nN}$$

Electrostatic forces are relevant for AFM!

Electrostatic force: relevance for AFM

- Electrostatic force acting on an electrode of any kind :

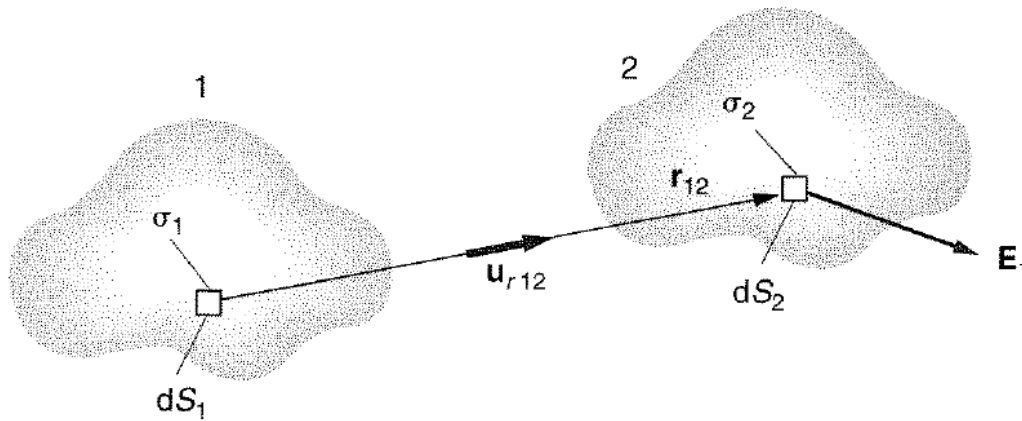

$$\mathbf{F}_{1 \rightarrow 2}^{\text{el}} = - \oint_{S_2} \sigma_2 dS_2 \mathbf{E}_1 \quad (\text{Eq.3d})$$

Towards Contact Potential Difference : work function in metals

K. Wandelt, Appl. Surf. Sci. 111, 1 (1997)

"The **work function** ϕ of an **infinite homogeneous metal surface** is defined as the energy difference between... the Fermi level... and a final state... the so called vacuum level."

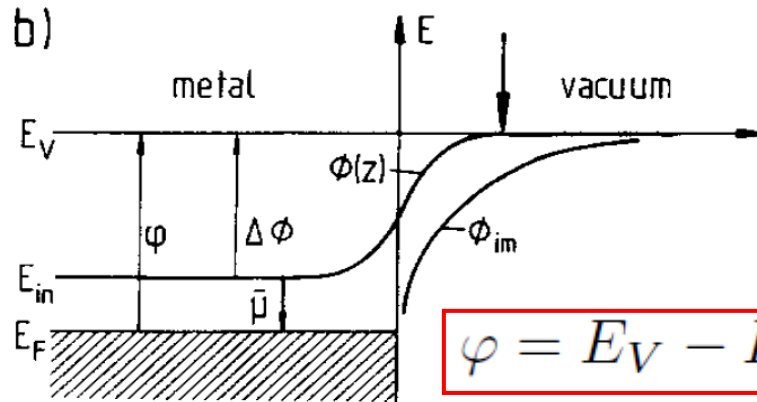
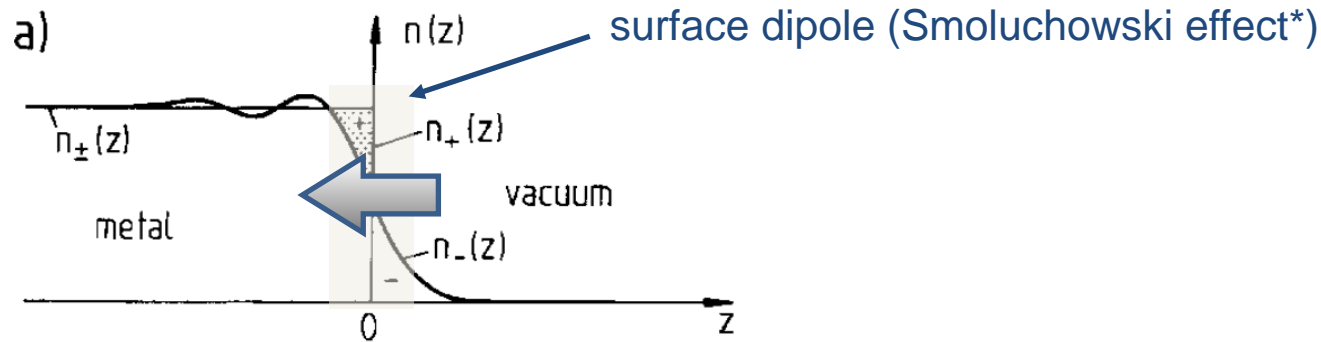

$$\phi = E_V - E_F = \Delta\Phi - \bar{\mu}$$

(Eq.4)

* Physics of surfaces and interfaces, H. Ibach, Springer 2006.

Electrostatic force and Contact Potential Difference (CPD)

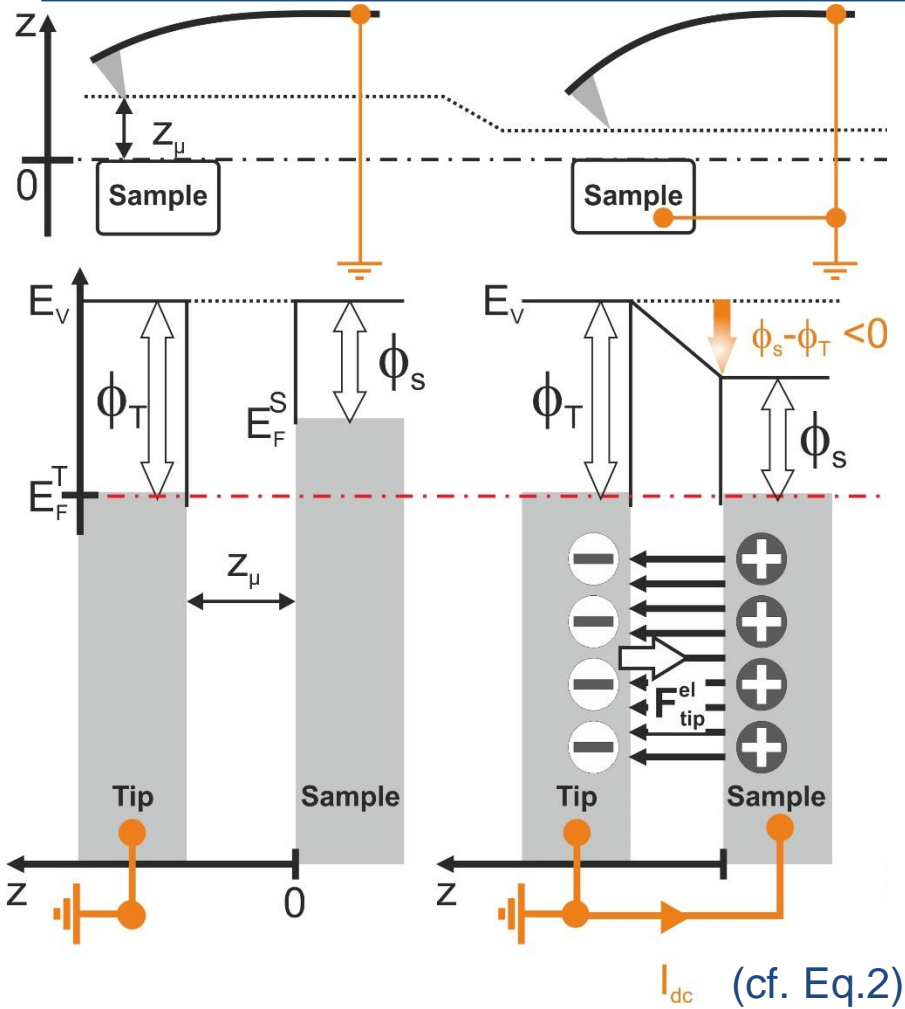

NB:

- $e = -1.6 \cdot 10^{-19} \text{ C} < 0$
- here, $V_{CPD} < 0$

$$V_{CPD} = \frac{\Delta\Phi}{|e|} = \frac{\Phi_{\text{sample}} - \Phi_{\text{tip}}}{|e|}$$

(Eq.5)

Electrostatic force and Contact Potential Difference (CPD)

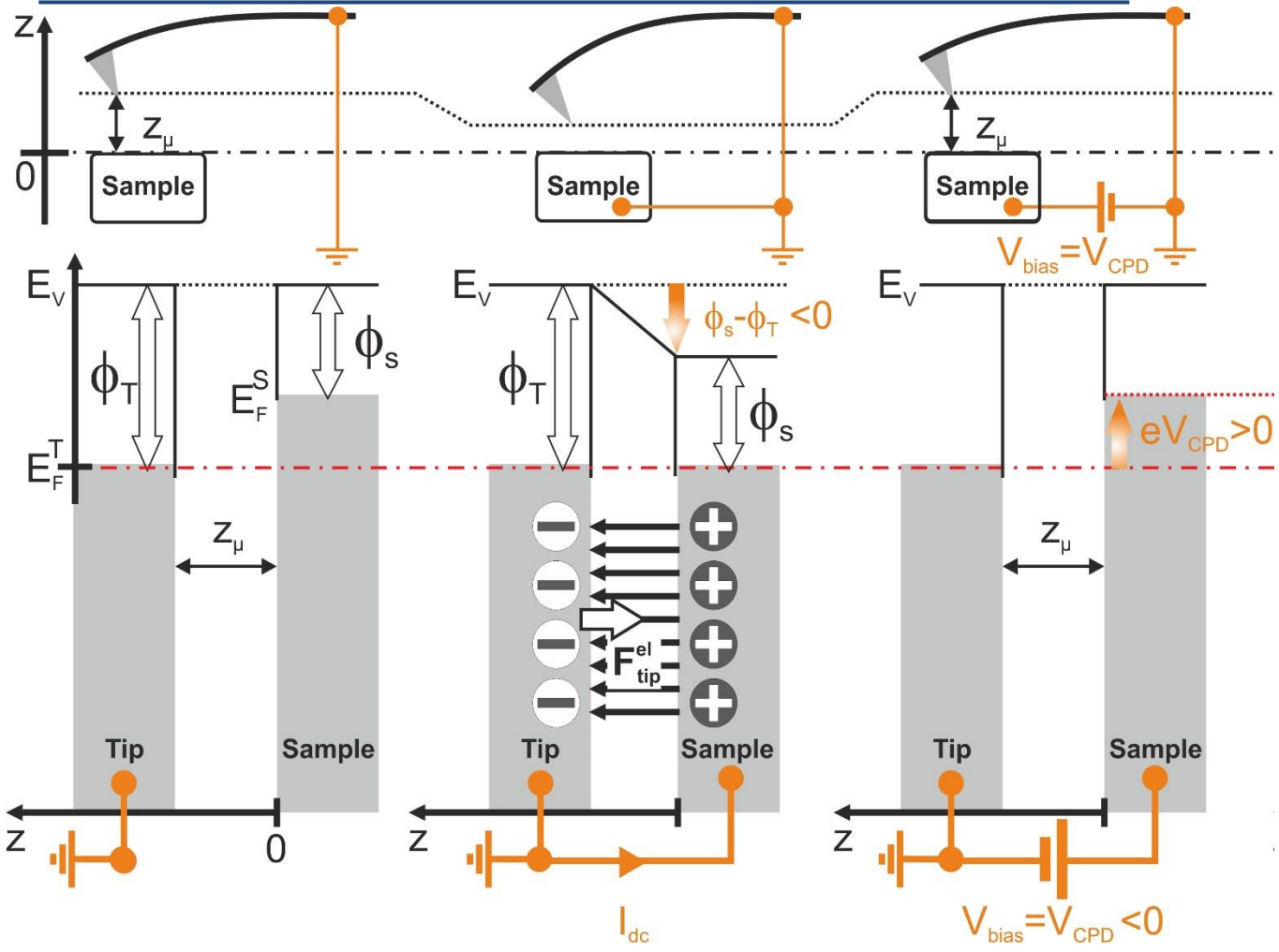

$V_{bias} = V_{CPD} \rightarrow$ electrostatic force compensation

Electrostatic force and Contact Potential Difference (CPD)

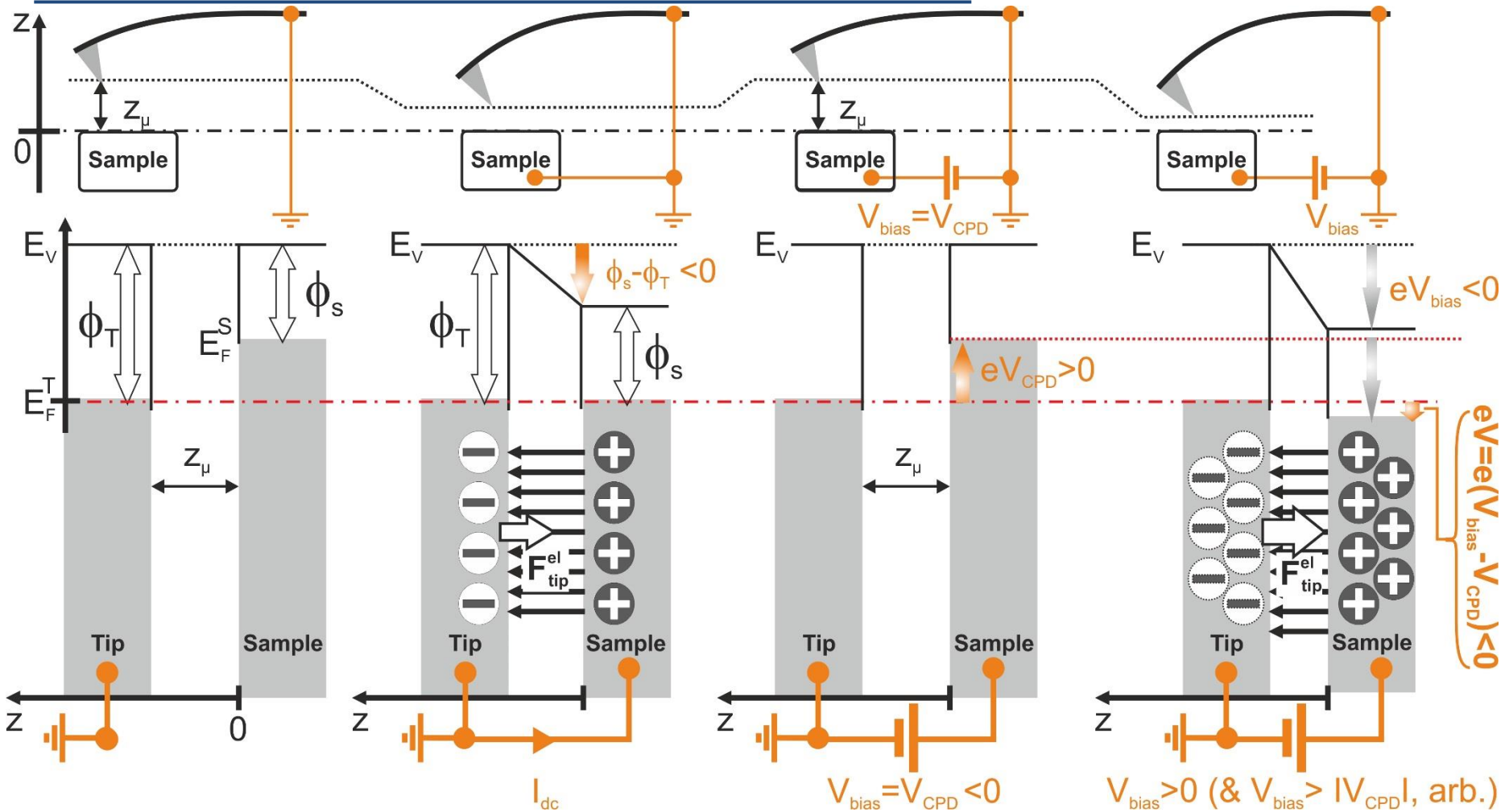

$$\mathbf{F}_{tip}^{el} = \frac{\partial W^{el}}{\partial z} \hat{\mathbf{z}} = -\frac{1}{2} \left| \frac{\partial C}{\partial z} \right| V^2 \hat{\mathbf{z}} = -\frac{1}{2} \left| \frac{\partial C}{\partial z} \right| (V_{bias} - V_{CPD})^2 \hat{\mathbf{z}} \quad (Eq.6)$$

Electrostatic force and Contact Potential Difference (CPD)

$$\mathbf{F}_{\text{tip}}^{\text{el}} = \frac{\partial W^{\text{el}}}{\partial z} \hat{\mathbf{z}} = -\frac{1}{2} \left| \frac{\partial C}{\partial z} \right| V^2 \hat{\mathbf{z}} = -\frac{1}{2} \left| \frac{\partial C}{\partial z} \right| (V_{\text{bias}} - V_{\text{CPD}})^2 \hat{\mathbf{z}} \quad (\text{Eq.6})$$

(empty capacitor)

- KPFM = **Detection** of tip-surface **electrostatic forces** and **compensation** with the proper dc bias on the sample* (while scanning) :

$$F_{\text{tip}}^{\text{el}} = 0 \Leftrightarrow V_{\text{bias}} = V_{\text{CPD}} \quad (\text{Eq.7})$$

- Concept valid on **any kind of surfaces (forces!)** : metals, semi-conductors & insulators, although with the latter, the concept of CPD is ambiguous...

* only if the tip is grounded and V_{bias} is applied to the sample, $V_{\text{bias}} = -V_{\text{CPD}}$ otherwise

Electrostatic force and Contact Potential Difference (CPD)

$$\mathbf{F}_{\text{tip}}^{\text{el}} = \frac{\partial W^{\text{el}}}{\partial z} \hat{\mathbf{z}} = -\frac{1}{2} \left| \frac{\partial C}{\partial z} \right| V^2 \hat{\mathbf{z}} = -\frac{1}{2} \left| \frac{\partial C}{\partial z} \right| (V_{\text{bias}} - V_{\text{CPD}})^2 \hat{\mathbf{z}} \quad (\text{Eq.6})$$

(empty capacitor)

- Thus, the KPFM signal was interpreted as a measurement of metallic samples' CPD :

$$F_{\text{tip}}^{\text{el}} = 0 \Leftrightarrow V_{\text{bias}} = V_{\text{CPD}} \quad (\text{Eq.7})$$

- **BUT** : Eqs.6 & 7 are valid for an empty capacitor, only:

- $F_{\text{tip}}^{\text{el}} \propto V^2$
- $V \rightarrow V(\cancel{x})$: *no charges and/or dipole inside the capacitor, unless otherwise*

$$F_{\text{tip}}^{\text{el}} = 0 \Rightarrow V_{\text{bias}} \neq V_{\text{CPD}}$$

Electrostatic force and Contact Potential Difference (CPD)

$$\mathbf{F}_{\text{tip}}^{\text{el}} = \frac{\partial W^{\text{el}}}{\partial z} \hat{\mathbf{z}} = -\frac{1}{2} \left| \frac{\partial C}{\partial z} \right| V^2 \hat{\mathbf{z}} = -\frac{1}{2} \left| \frac{\partial C}{\partial z} \right| (V_{\text{bias}} - V_{\text{CPD}})^2 \hat{\mathbf{z}} \quad (\text{Eq.6})$$

(empty capacitor)

- Yet, charges or dipoles (defects, vacancies, hetero-adsorbates...) systematically occur at the tip-surface interface: **models required to interpret F^{el} and hence, the KPFM signal (« CPD »)**

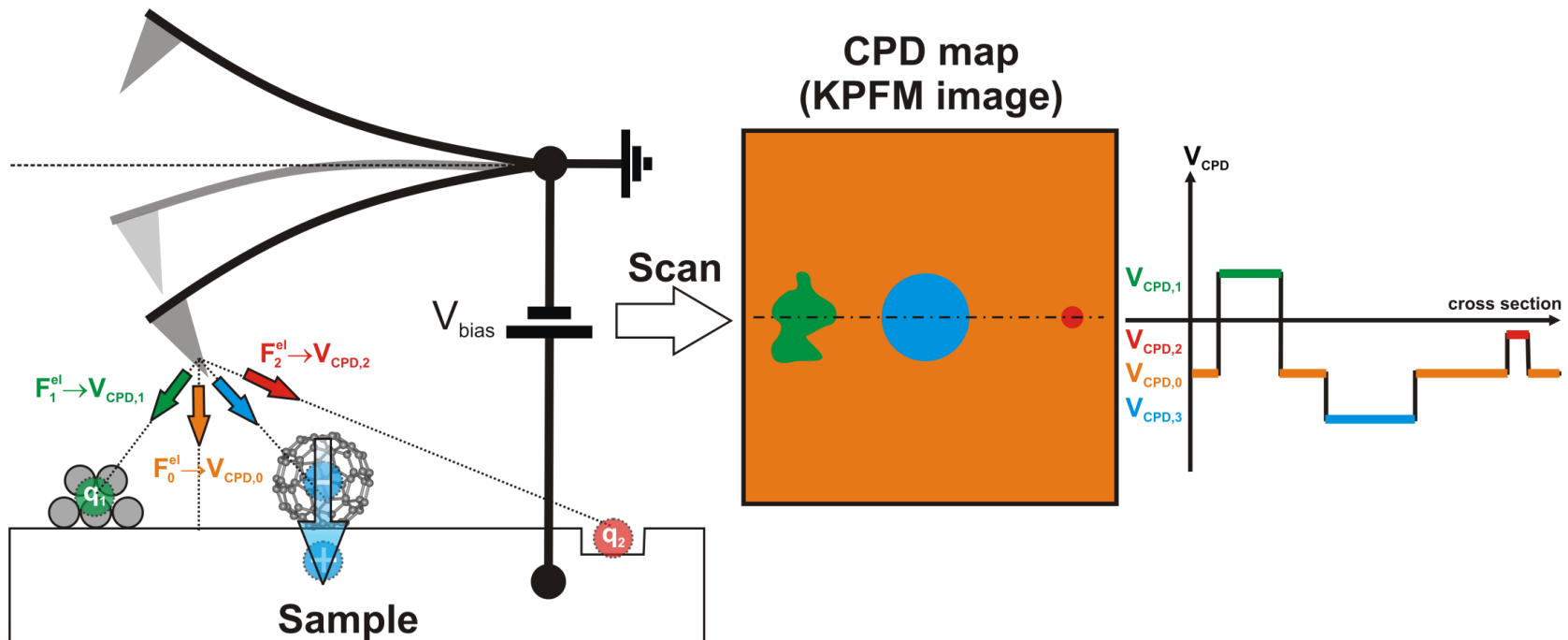

Local work function in metals

K. Wandelt, Appl. Surf. Sci. 111, 1 (1997)

"The **work function** ϕ of an **infinite homogeneous metal** surface is defined as the energy difference between... the Fermi level... and a final state... the so called vacuum level."

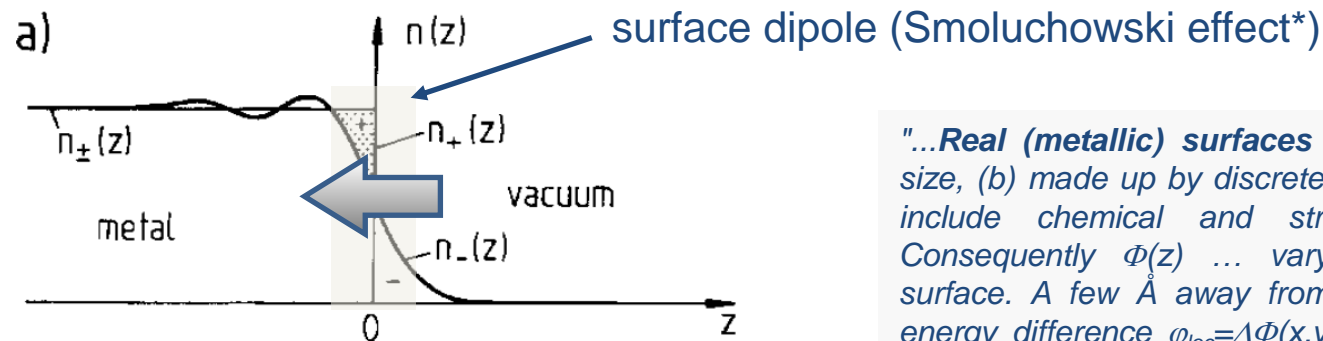

"...**Real (metallic) surfaces** are (a) of limited size, (b) made up by discrete atoms, (c) mostly include chemical and structural defects... Consequently $\Phi(z)$... vary parallel to the surface. A few Å away from the surface, the energy difference $\phi_{loc} = \Delta\Phi(x,y,z) - \bar{\mu}$ acquires the character of a **local work function**"

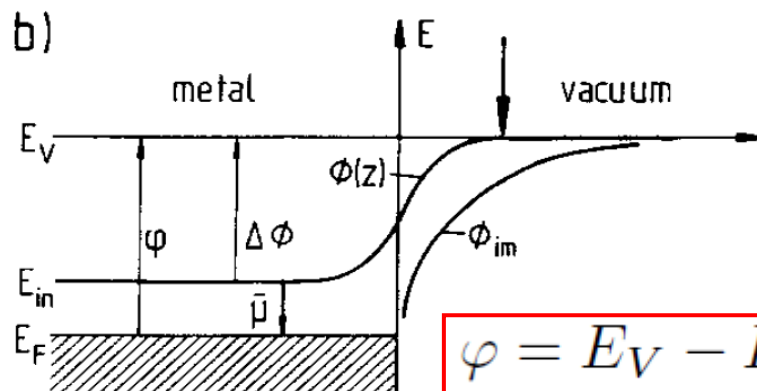

KPFM

Local Contact Potential Difference (LCPD)
= Long- & Short-Range Electrostatic forces

$$\phi = E_V - E_F = \Delta\Phi - \bar{\mu}$$

* Physics of surfaces and interfaces, H. Ibach, Springer 2006.

Non bias-dependant forces at play for AFM

- Sphere-plane geometry (vdW) + Morse or LJ contribution¹:

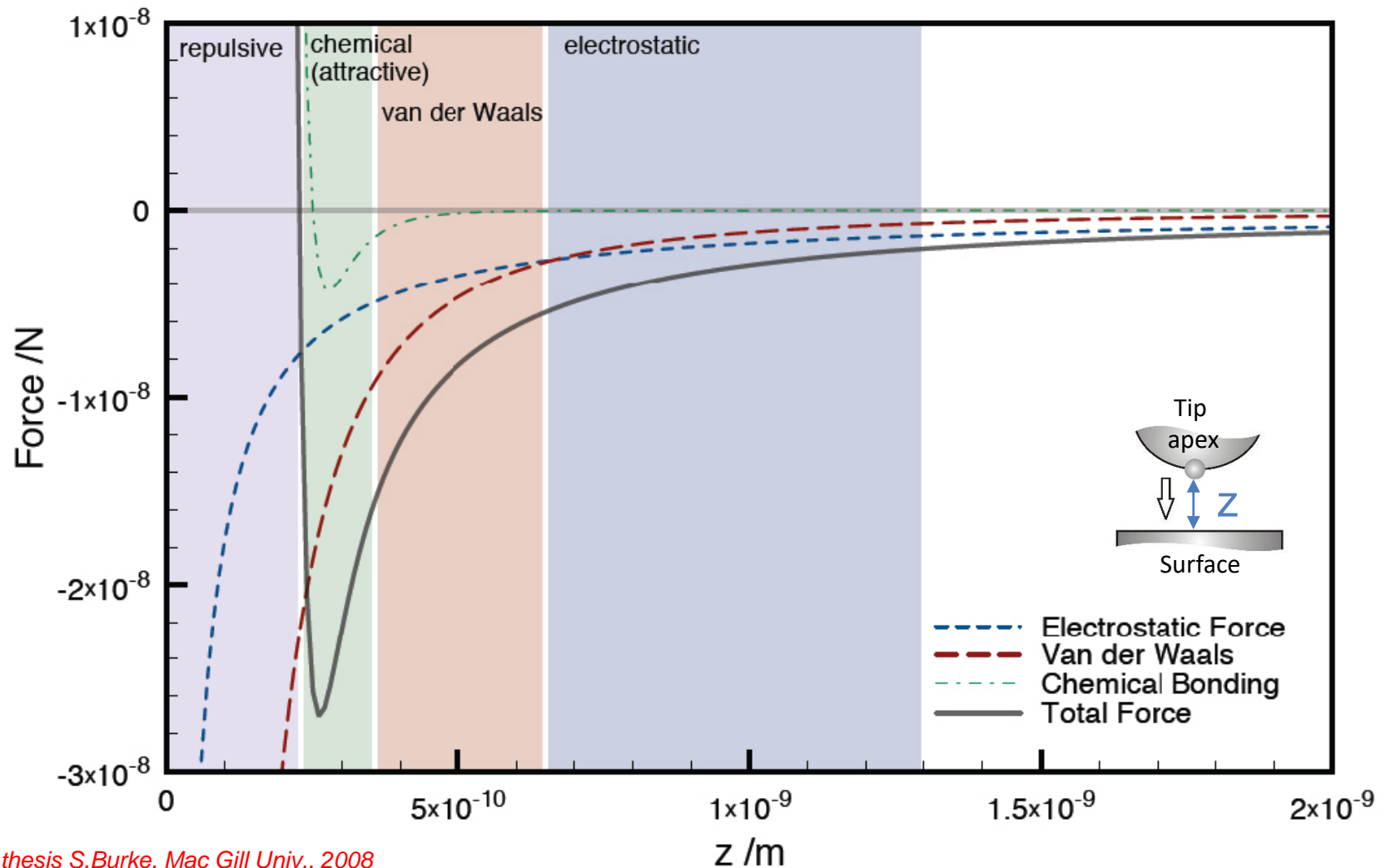

¹PhD thesis S.Burke, Mac Gill Univ., 2008

Total force field

$$\vec{F}_{\text{tot}} = \vec{F}_{\text{LR}} + \vec{F}_{\text{SR}} = \left[\vec{F}_{\text{LR}}^{\text{el}} + \vec{F}_{\text{LR}}^{\text{vdW}} \right] + \left[\vec{F}_{\text{SR}}^{\text{el}} + \vec{F}_{\text{SR}}^{\text{vdW}} \right] \quad (\text{Eq.8})$$

4D vectorial field: X, Y, Z, V_{bias}

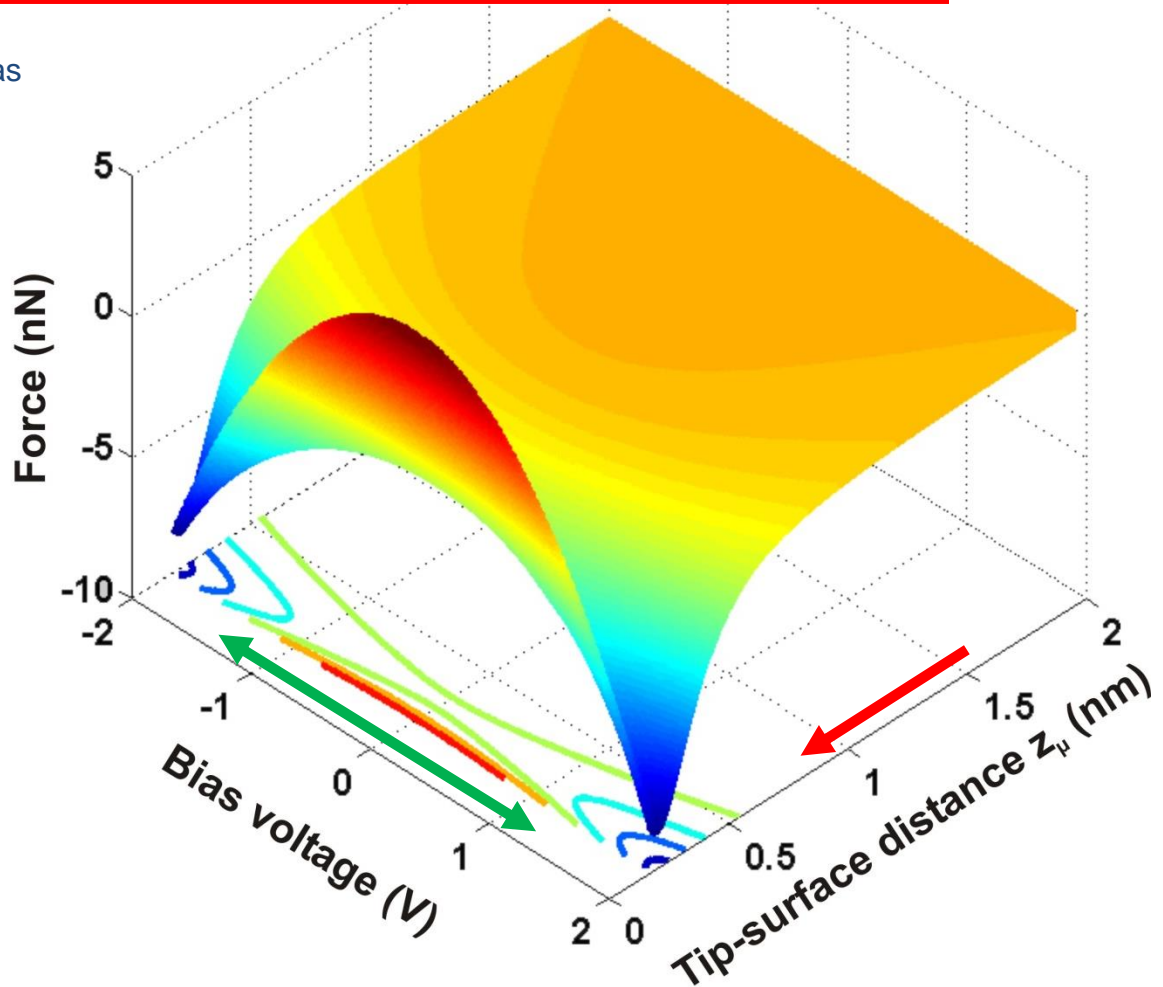
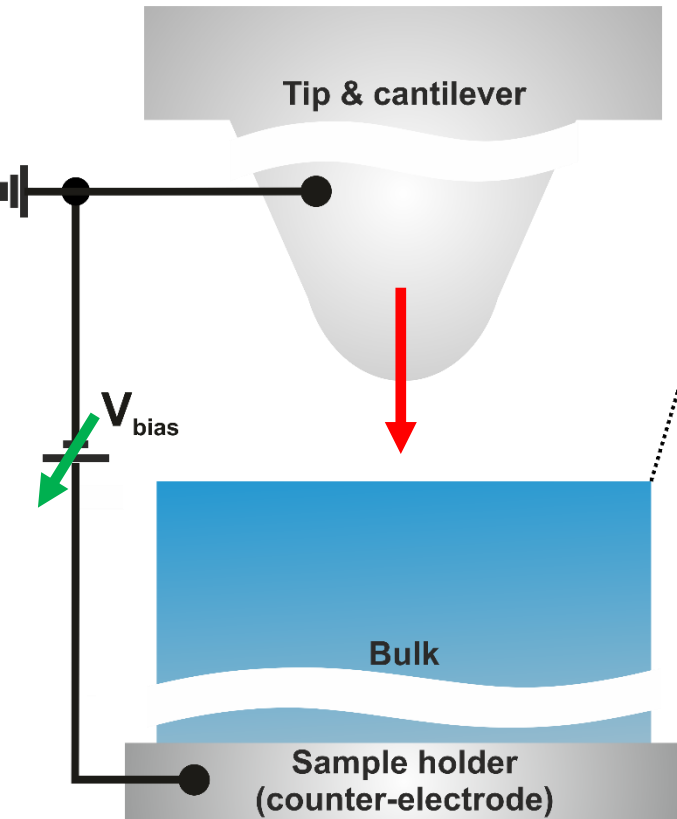

Long- and short-range electrostatic forces in KPFM

$$\vec{F}_{tot} = \vec{F}_{LR} = \left[\vec{F}_{LR}^{el} + \vec{F}_{LR}^{vdW} \right]$$

$$= -\frac{1}{2} \frac{\partial C}{\partial z} V^2 \hat{z}$$

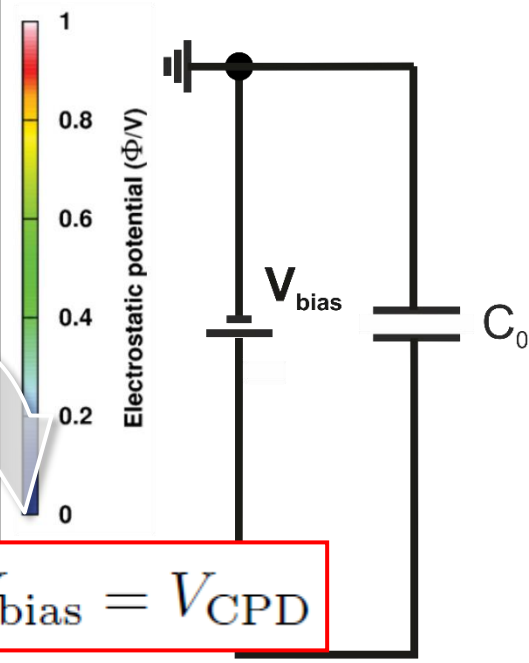
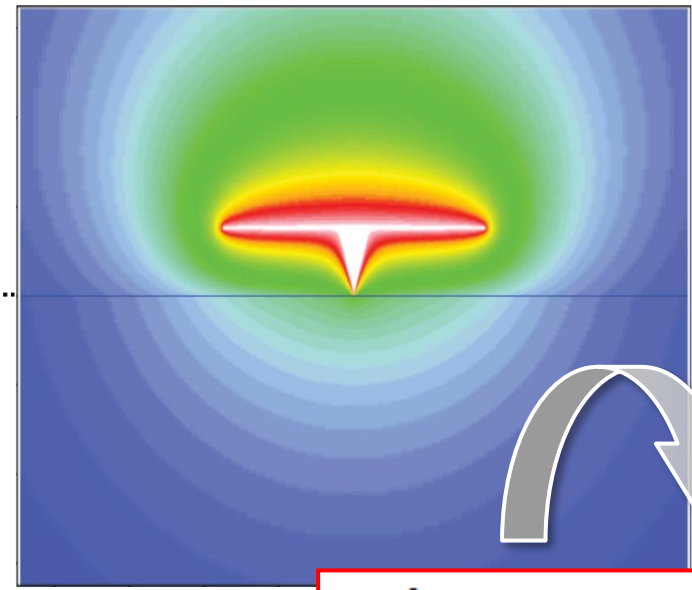
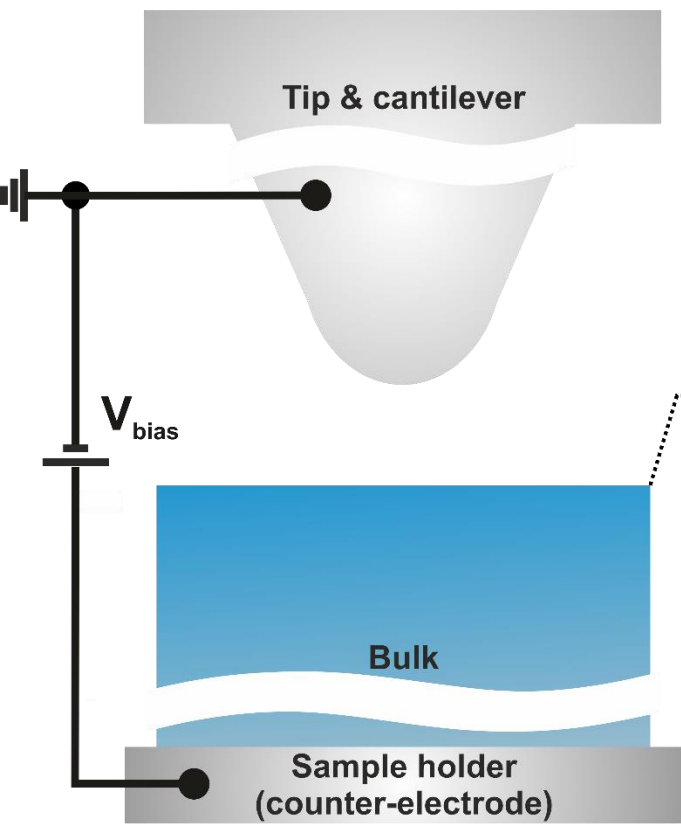

$$F_{tip}^{el} = 0 \Leftrightarrow V_{bias} = V_{CPD}$$

Long- and short-range electrostatic forces in KPFM

$$\vec{F}_{\text{tot}} = \vec{F}_{\text{LR}} = \left[\vec{F}_{\text{LR}}^{\text{el}} + \vec{F}_{\text{LR}}^{\text{vdW}} \right]$$

$$-\frac{1}{2} \frac{\partial C}{\partial z} V^2 \hat{\mathbf{z}} + \dots$$

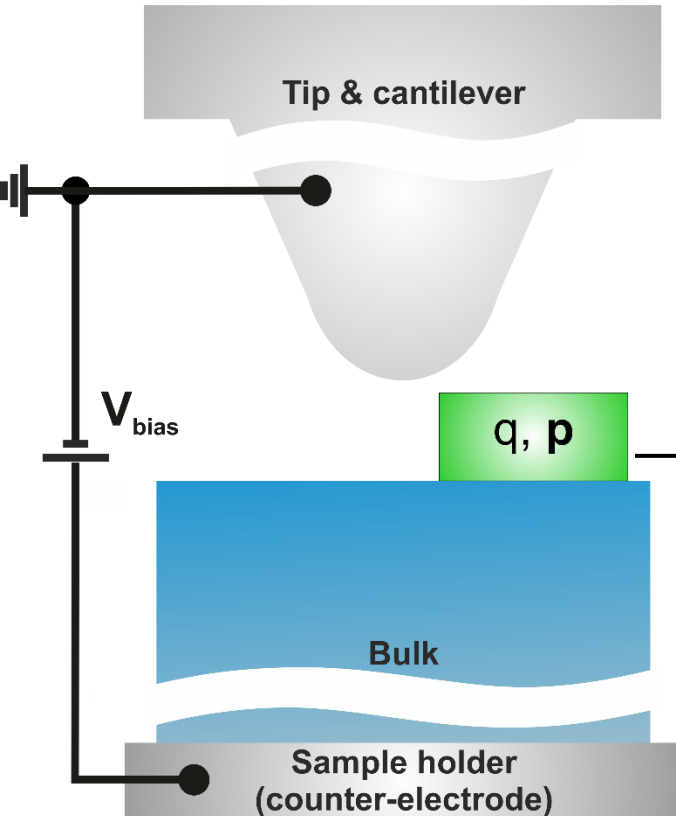

$$F_{\text{tip}}^{\text{el}} = 0 \Rightarrow V_{\text{bias}} \neq V_{\text{CPD}}$$

Mesoscopic objects (whose size is comparable or smaller than the tip)

Long- and short-range electrostatic forces in KPFM

$$\vec{F}_{\text{tot}} = \vec{F}_{\text{LR}} + \vec{F}_{\text{SR}} = \left[\vec{F}_{\text{LR}}^{\text{el}} + \vec{F}_{\text{LR}}^{\text{vdW}} \right] + \left[\vec{F}_{\text{SR}}^{\text{el}} + \vec{F}_{\text{SR}}^{\text{vdW}} \right] \quad (\text{Eq.8})$$

$$-\frac{1}{2} \frac{\partial C}{\partial z} V^2 \hat{\mathbf{z}} + \dots$$

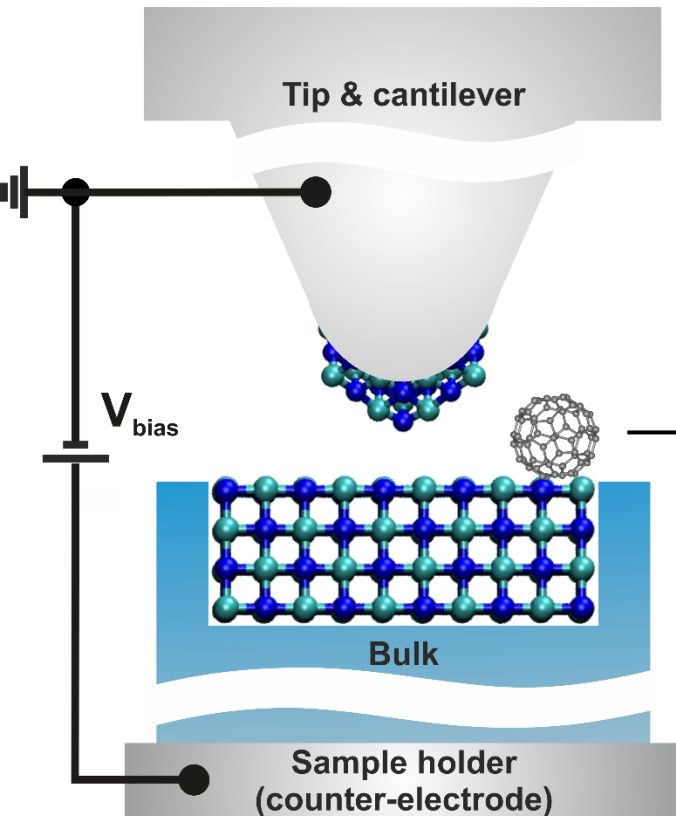

$$F_{\text{tip}}^{\text{el}} = 0 \Rightarrow V_{\text{bias}} \neq V_{\text{CPD}}$$

Sign of the charge & dipole orientation (tip grounded)*

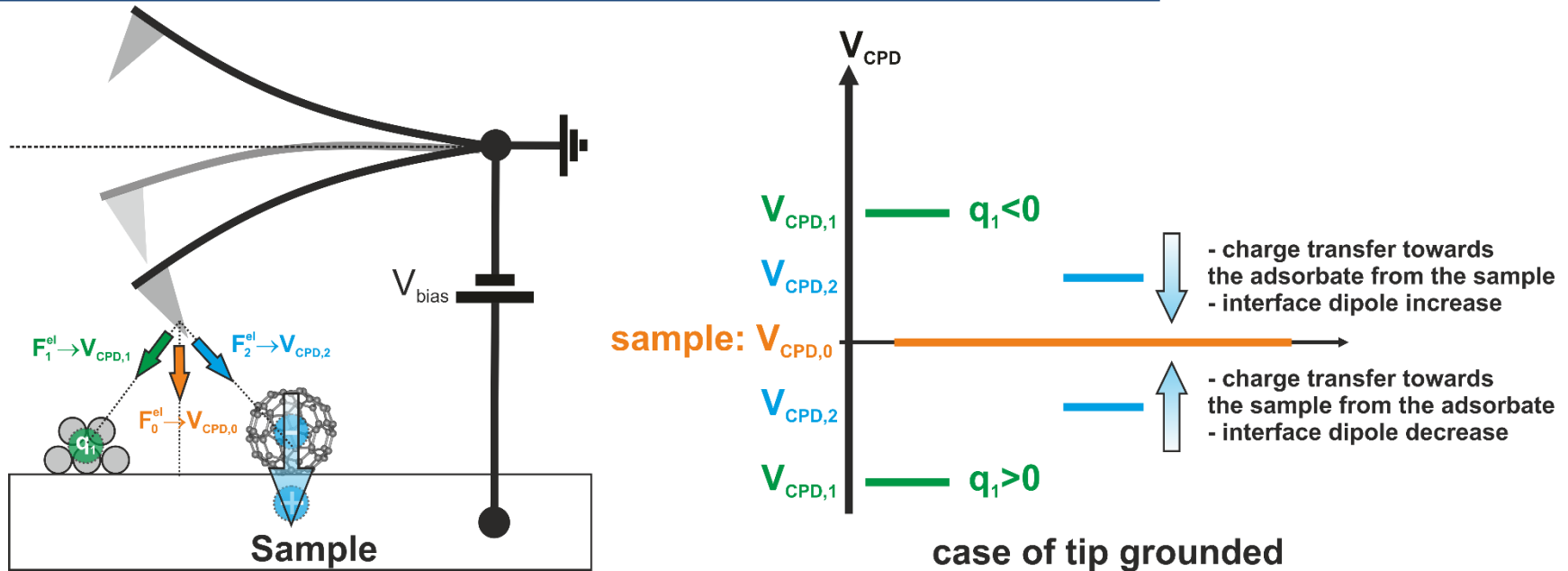

Local quantity α	Sign, orientation	CPD shift: $V_{\text{CPD},\alpha} - V_{\text{CPD},0}$	« Local WF interpretation » $\Phi_{\text{sample},\alpha} - \Phi_{\text{sample},0}$
Charge q	+	< 0	< 0 : decrease
	-	> 0	> 0 : increase
Dipole p	\uparrow	< 0	< 0 : decrease
	\downarrow	> 0	> 0 : increase

*consistent with most frequently reported results (see « References » section)

Experimental illustration

□ ZnPcCl₈ on Ag(111)*:

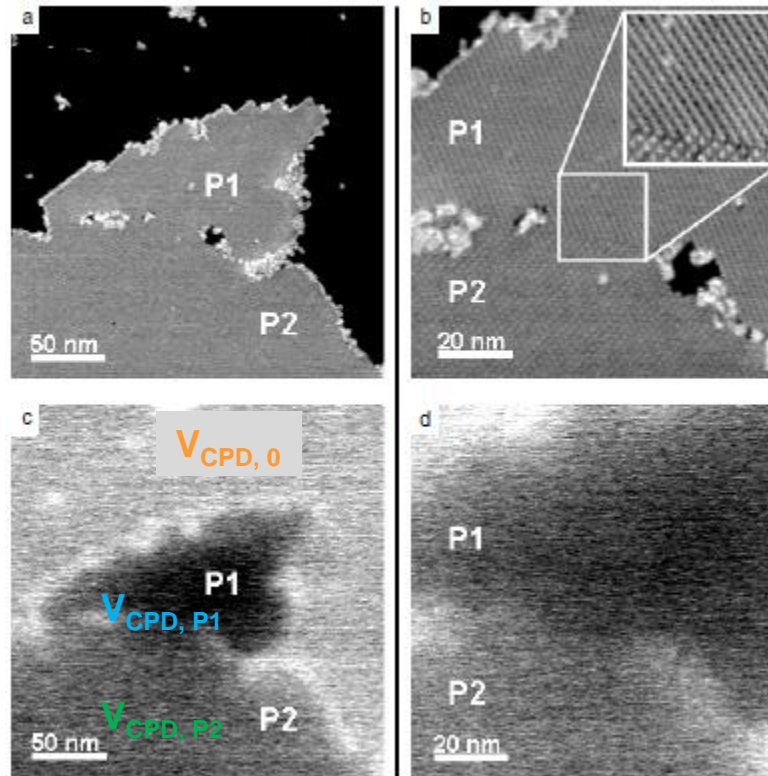
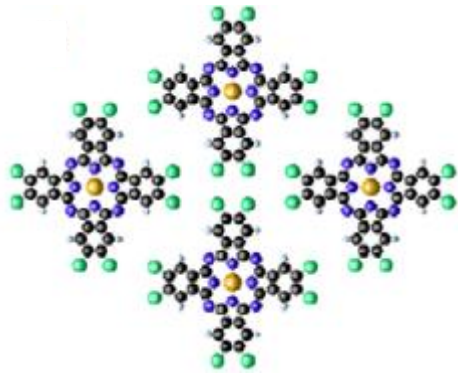

- $V_{\text{CPD}, 0} = 4.73 \text{ V}$
- $V_{\text{CPD}, \text{P1}} = V_{\text{CPD}, \text{ref}} - 103 \text{ mV}$ → negative shift → layer gets « + » charged → interf. dip. decreased
- $V_{\text{CPD}, \text{P2}} = V_{\text{CPD}, \text{ref}} - 54 \text{ mV}$ → idem, but less than with P1

*P. Milde *et al.* Nanotechnology **19**, 305501 (2008)

Summary...

- ❑ KPFM = **compensation of attractive electrostatic forces** occurring between the tip and the surface forming a capacitor by tuning V_{bias} .
- ❑ The concept stands on **any kind of sample** (metal, insulator, semi-conductor)
- ❑ For an « empty capacitor », the electrostatic force is written:

$$\mathbf{F}_{\text{tip}}^{\text{el}} = \frac{\partial W^{\text{el}}}{\partial z} \hat{\mathbf{z}} = -\frac{1}{2} \left| \frac{\partial C}{\partial z} \right| V^2 \hat{\mathbf{z}} = -\frac{1}{2} \left| \frac{\partial C}{\partial z} \right| (V_{\text{bias}} - V_{\text{CPD}})^2 \hat{\mathbf{z}}$$

- ❑ Therefore:

$$F_{\text{tip}}^{\text{el}} = 0 \Leftrightarrow V_{\text{bias}} = V_{\text{CPD}}$$

- ❑ This is an **over-interpretation** with real samples since charges and/or dipoles are always present at the surface. Hence, the V_{bias} and z -dependence of the electrostatic force is to be quantified to interpret what the **KPFM signal, i.e. the local « CPD », actually conceals** → « **surface potential** » is more appropriate
- ❑ The sign of the « CPD » shift w.r.t. the mean « CPD » gives the sign of the charge and/or of the surface dipole present on the surface
- ❑ Electrostatic forces are superimposed to other, non-bias dependant forces (vdW, Morse...), to form an (x,y,z,V_{bias}) force landscape influencing the tip of the AFM

Outline

I. INTRODUCTION to KPFM

II. CONCEPTS & IMPLEMENTATIONS

III. ELECTROSTATIC MODELS



IV. EXAMPLES OF APPLICATIONS



CONCLUSION

Some references...

II. Concepts & implementations

Motivation

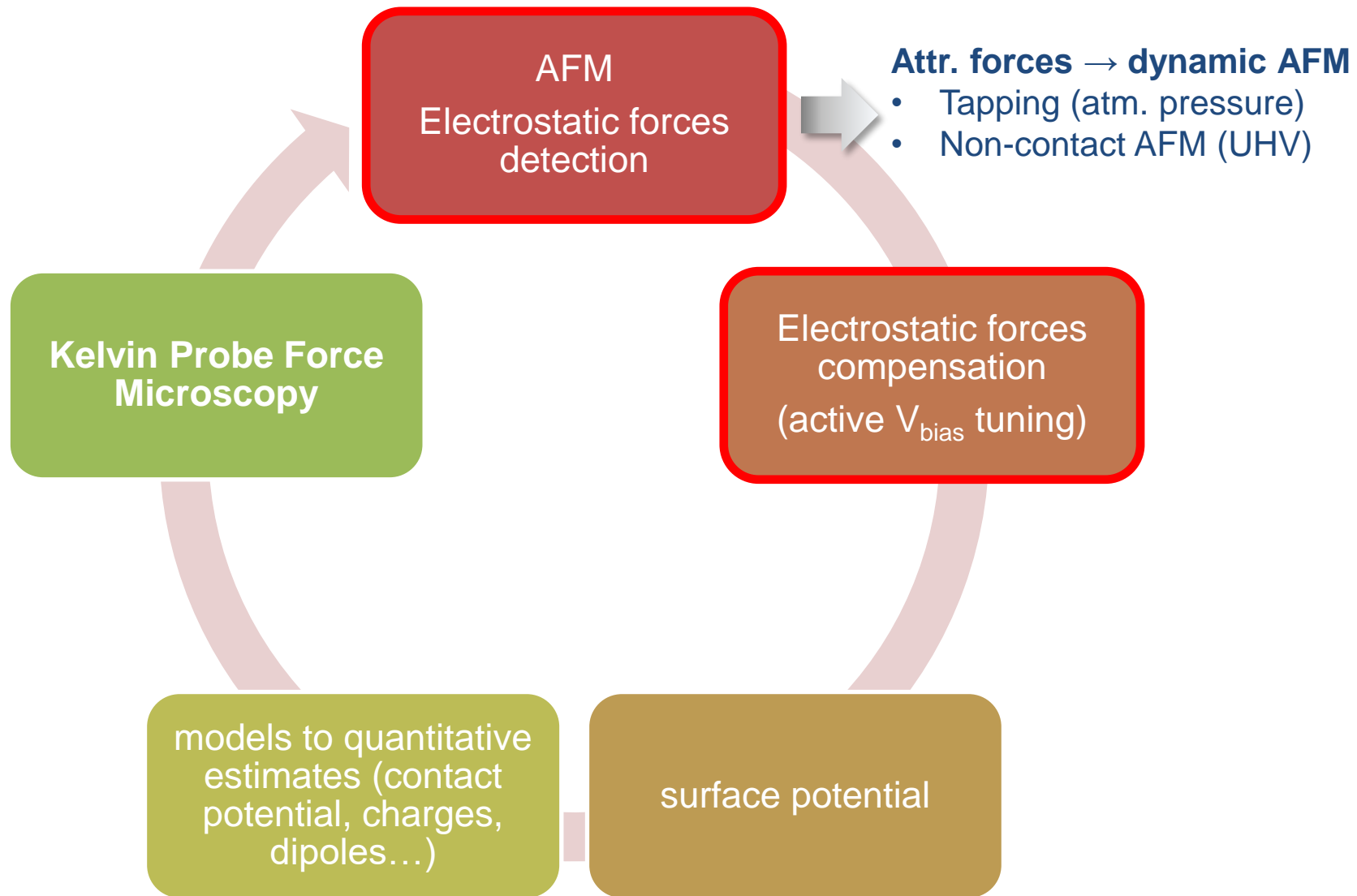

Dynamic AFM (1): Tapping mode

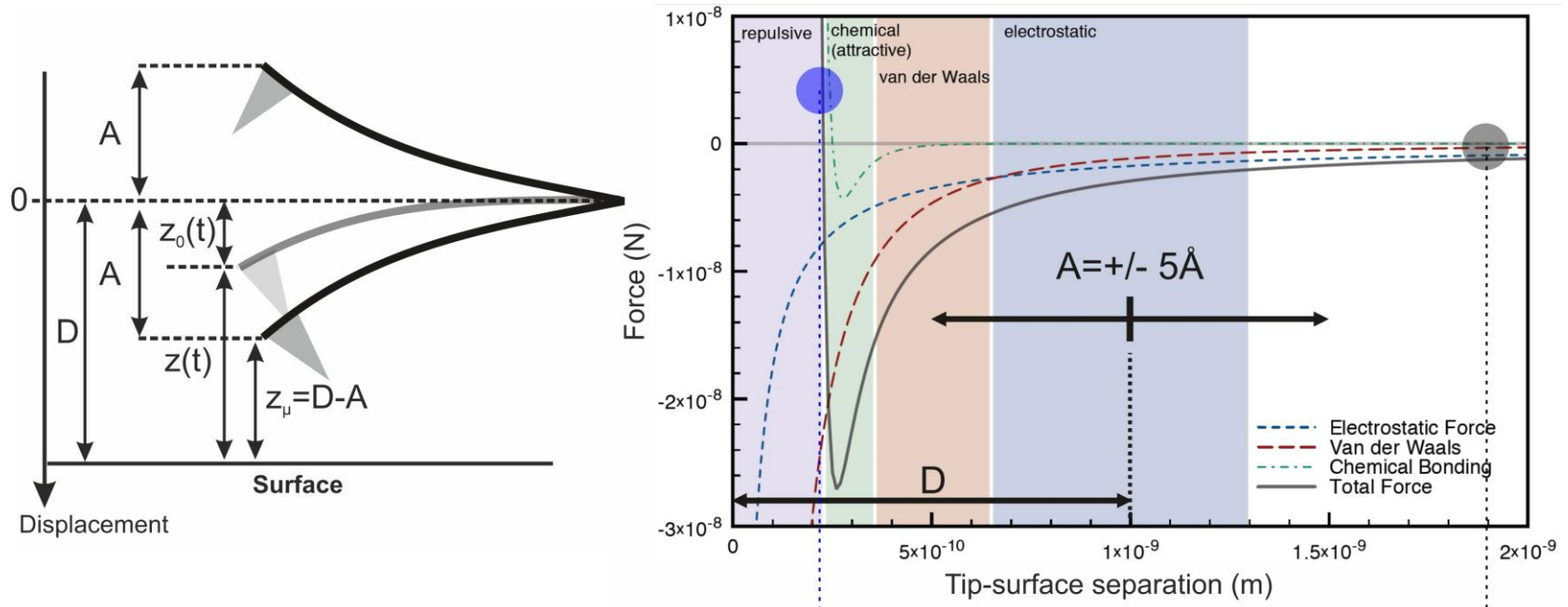

Dynamic AFM (1): Tapping mode

- Constant excitation amplitude
- Constant excitation frequency

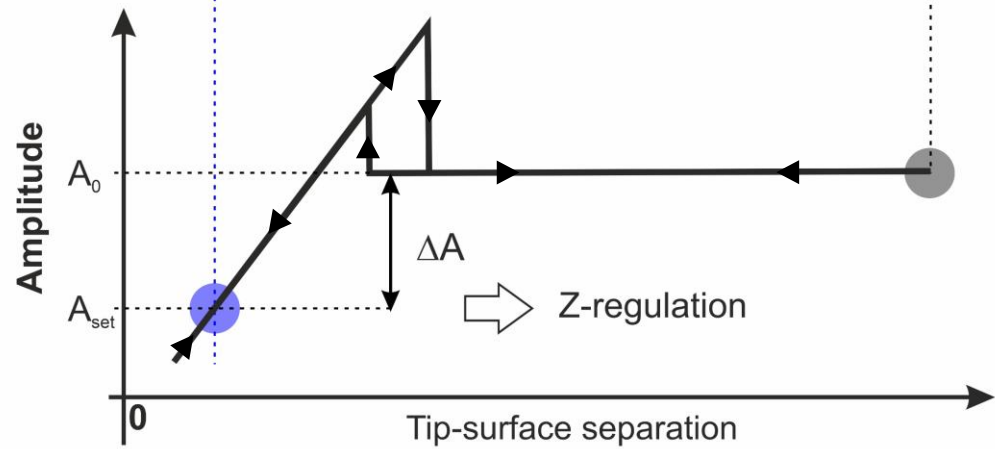
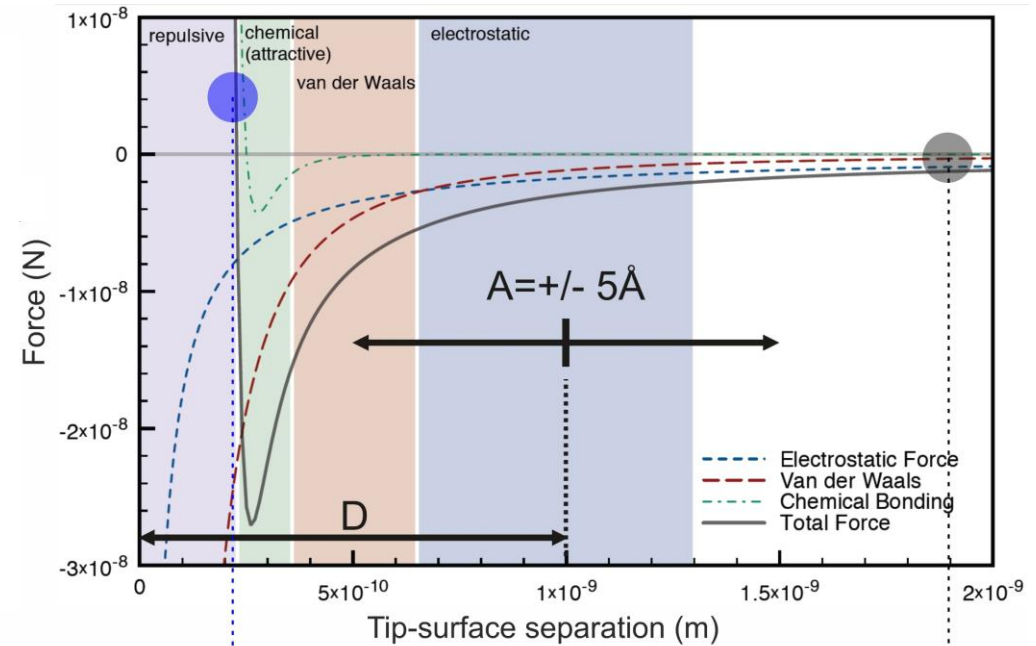
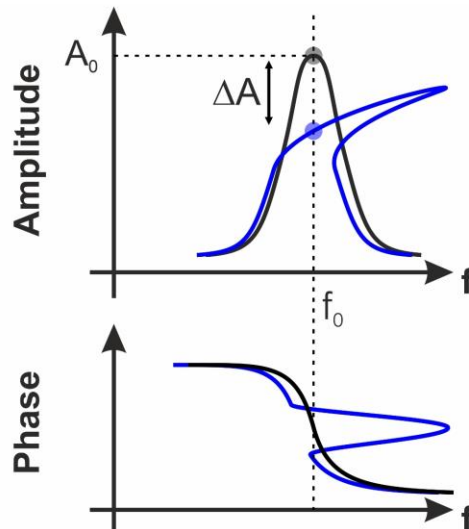

Dynamic AFM (1): Tapping mode

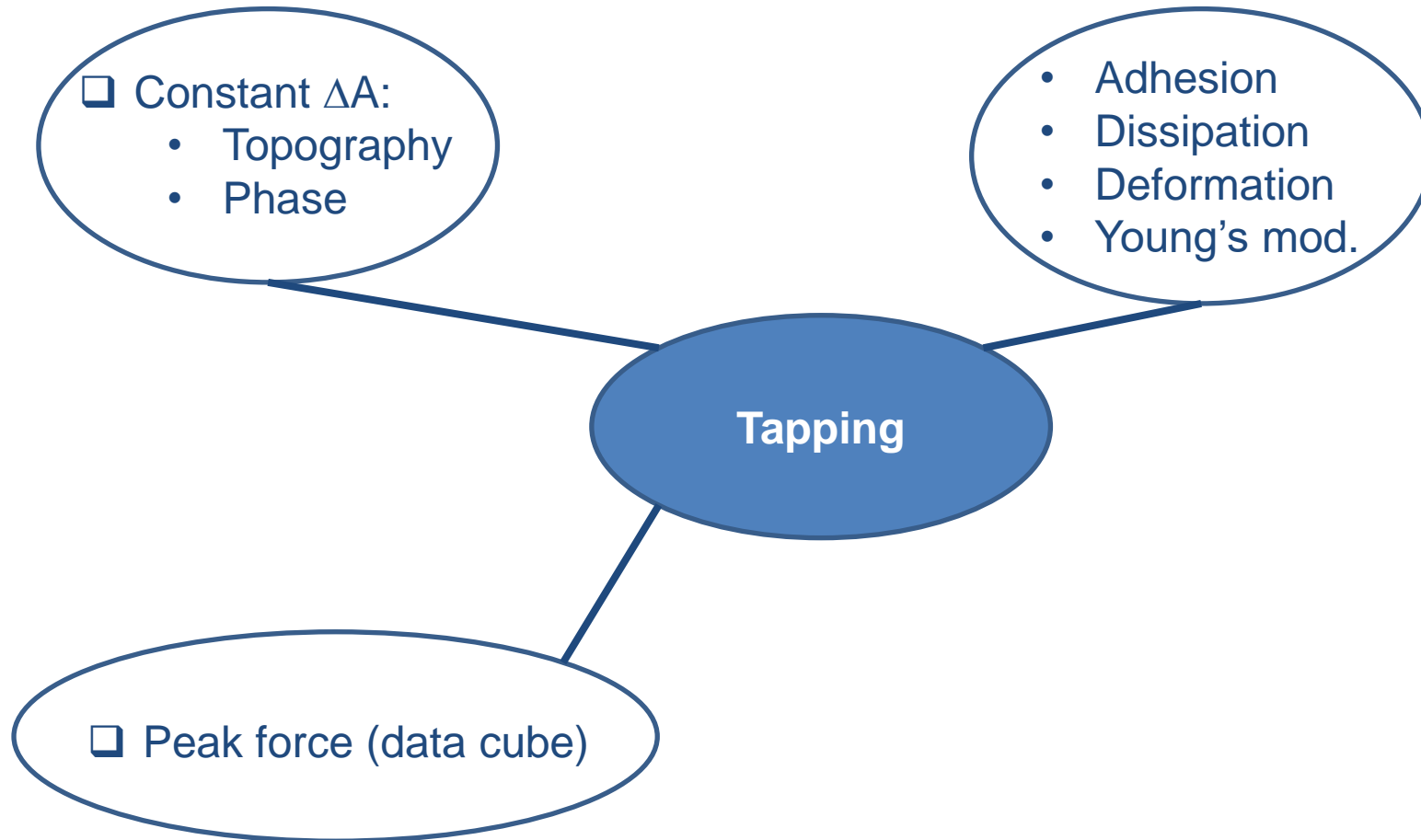

Dynamic AFM (1): Tapping mode

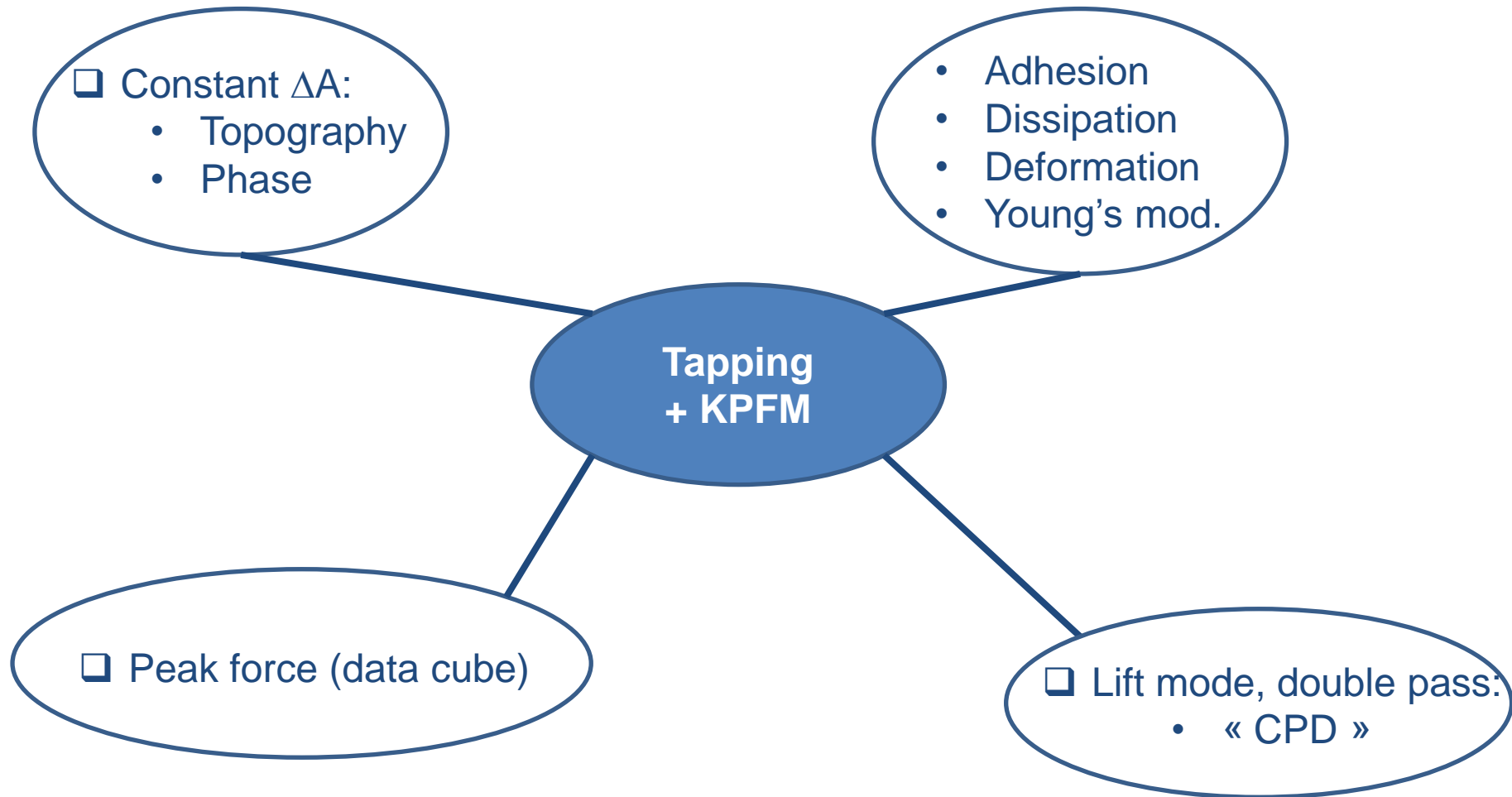

Dynamic AFM (2): non contact-AFM

- Constant phase (resonance f_0)
- Constant amplitude (A_0)
- Phase locked loop (PLL)

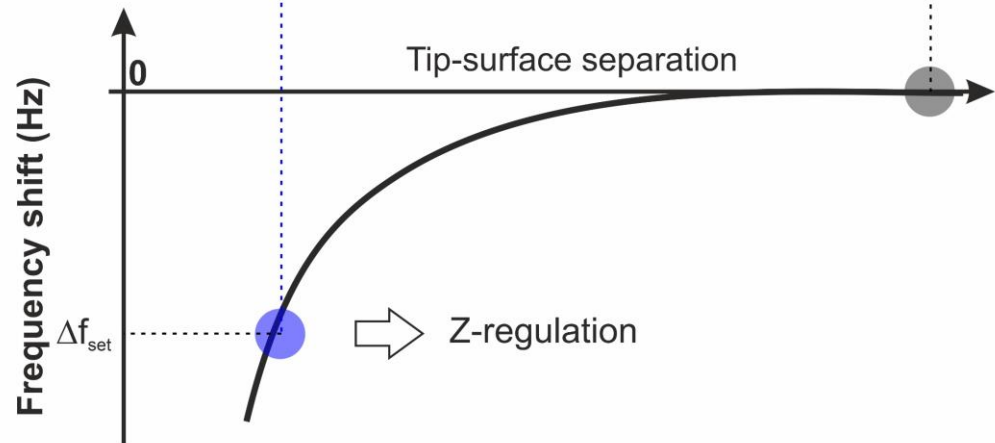
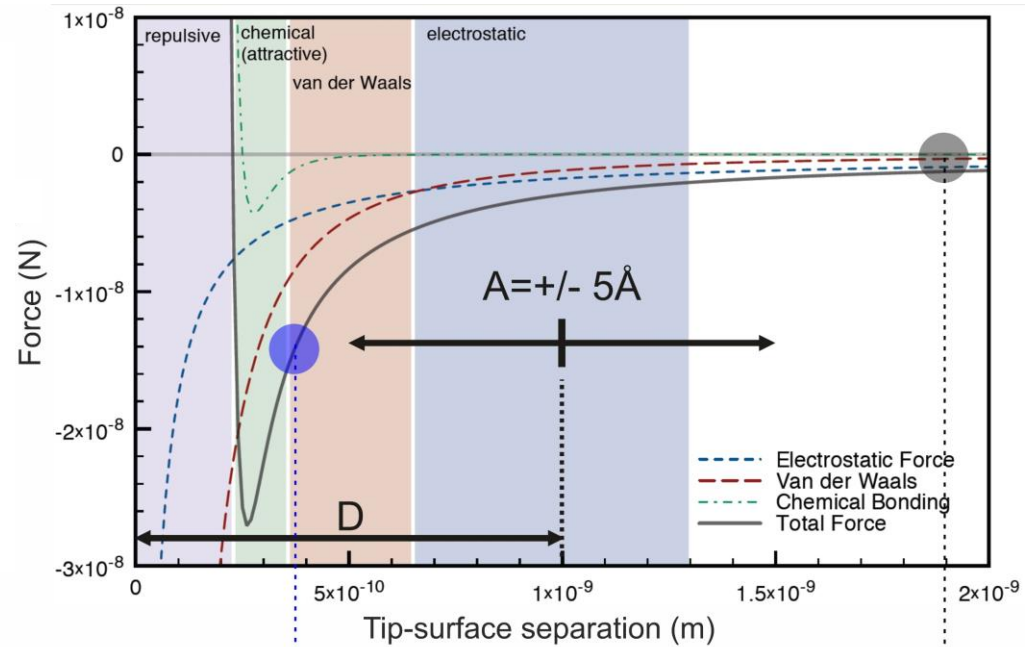
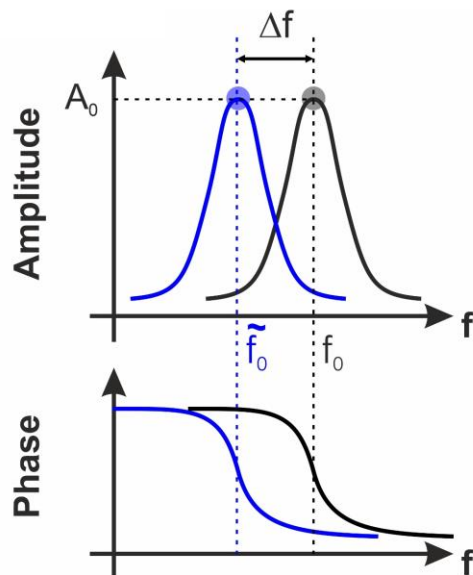

Dynamic AFM (2): non contact-AFM

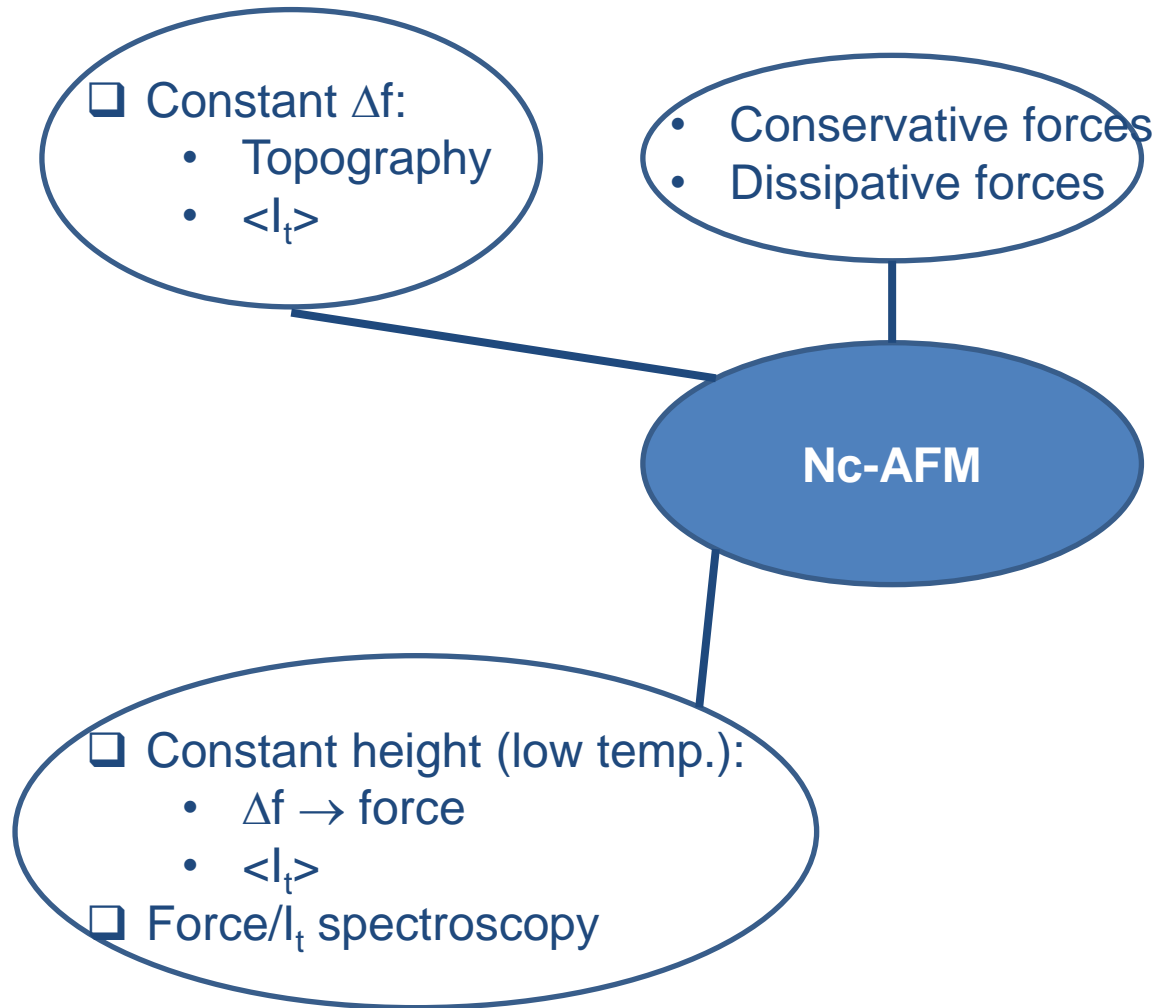

Dynamic AFM (2): non contact-AFM

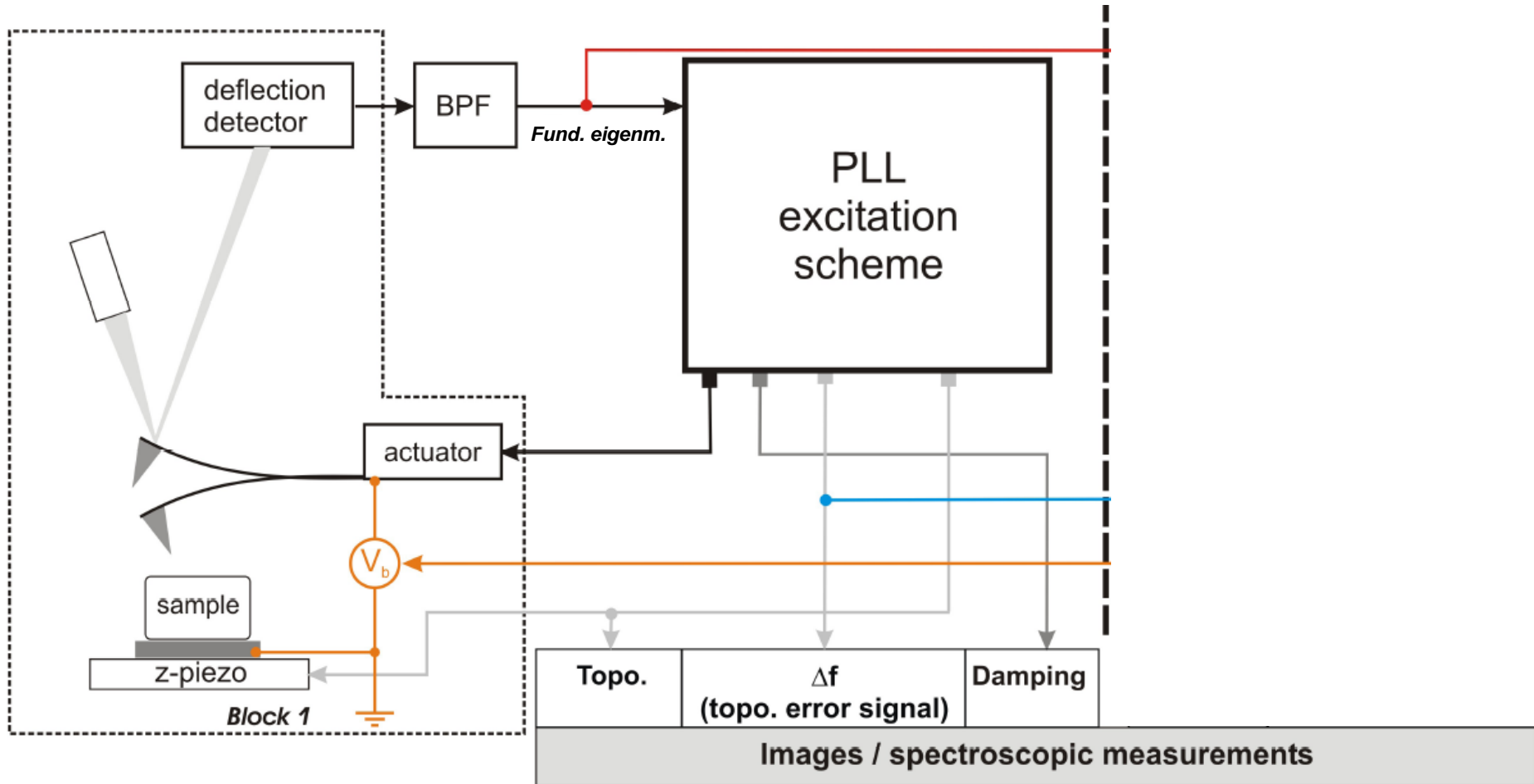

Dynamic AFM (2): non contact-AFM

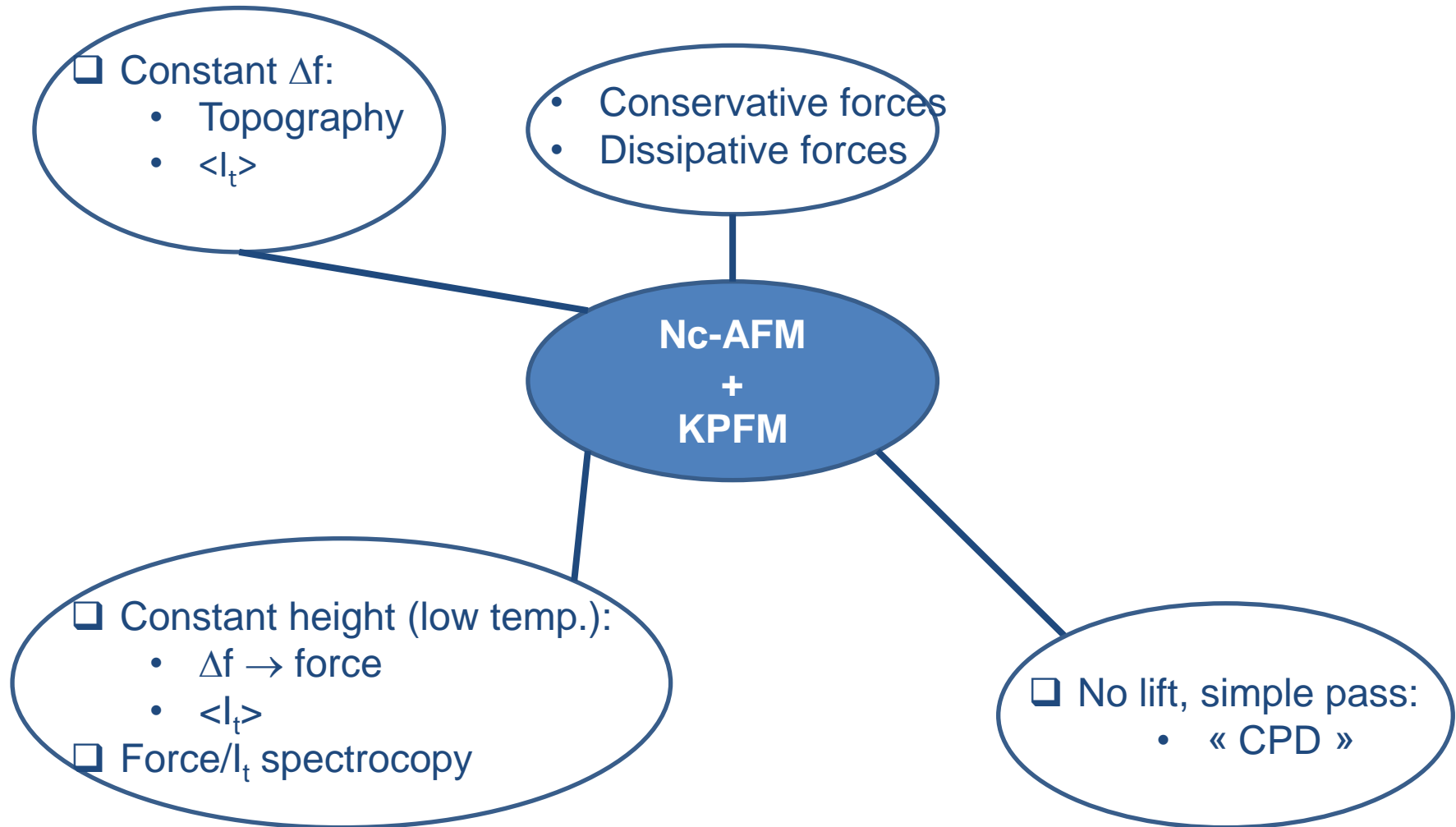

Dynamic AFM (2): non contact-AFM

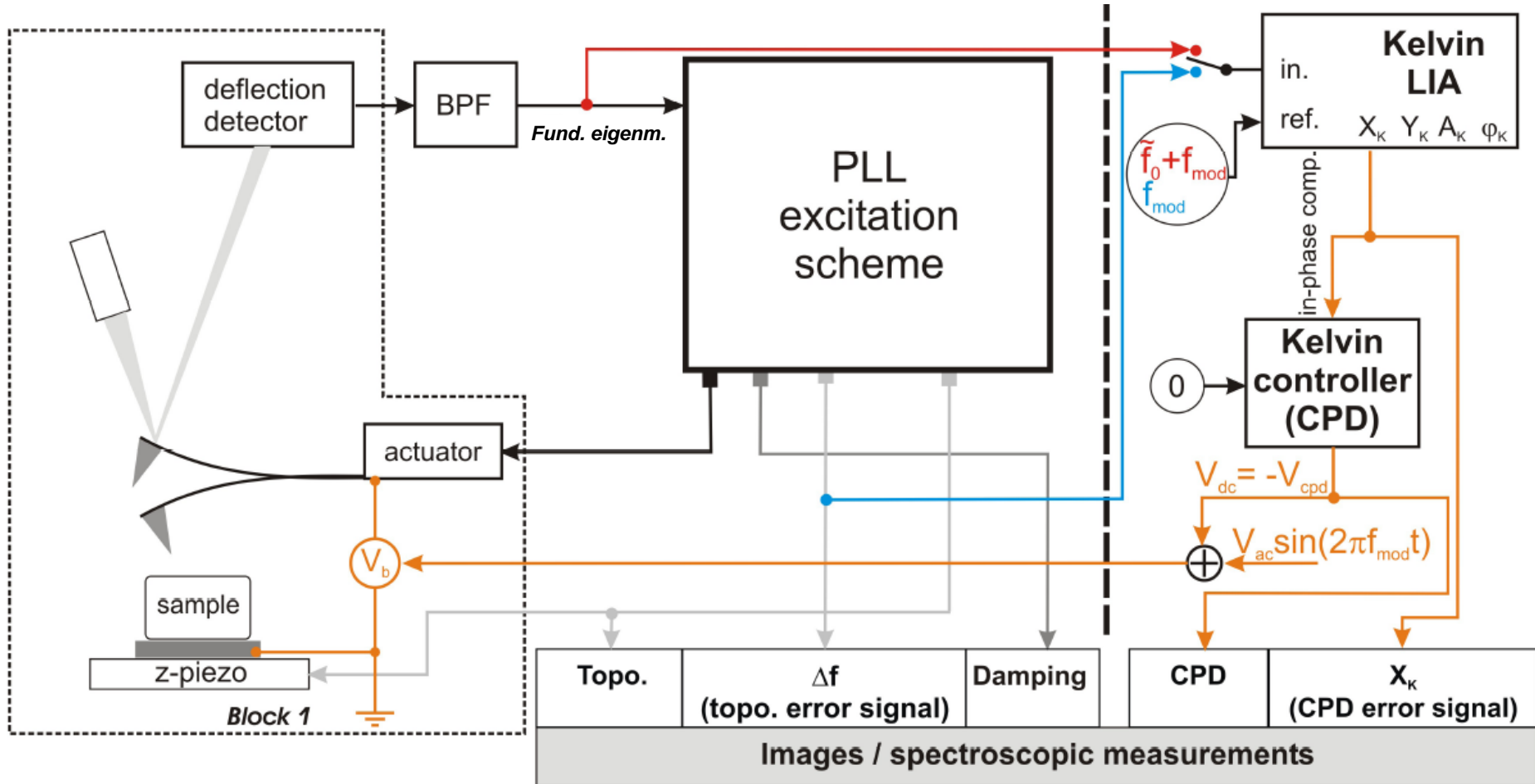

KPFM : concepts

Idea* : bias modulation \rightarrow discriminating F^{el}

Bias voltage applied
between the tip and the
surface (tip grounded) :

$$V_{bias} = V_{dc} + V_{ac} \sin(2\pi f_{mod} t)$$

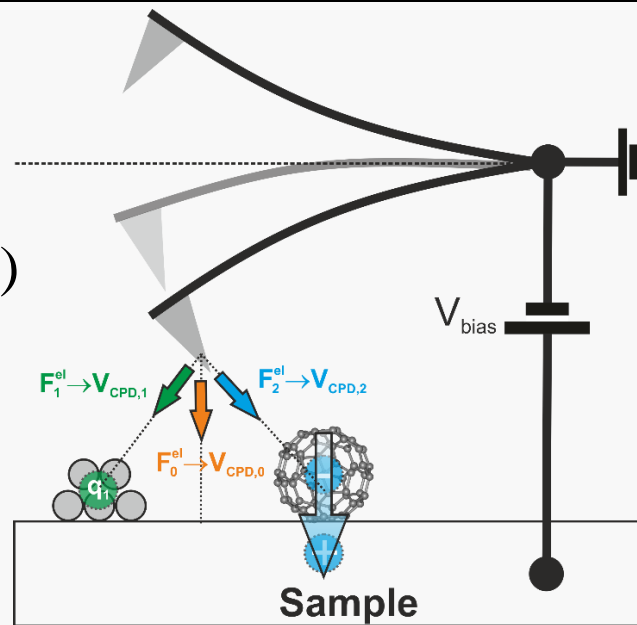

Non contact-AFM:

Oscillation at f_0
(Force(z) \rightarrow $\Delta f(z)$)

*M. Nonnenmacher et al., APL **58**, 2921 (1991); J. Weaver et al. JVSTB **9**, 1559 (1991)

KPFM : concepts

- Attractive electrostatic force (empty capacitor) :

$$F_{\text{tip}}^{\text{el}} = +\frac{1}{2} \frac{\partial C(z)}{\partial z} [V_{\text{dc}} - V_{\text{CPD}} + V_{\text{ac}} \sin(2\pi f_{\text{mod}} t)]^2 \quad (\text{Eq.9})$$

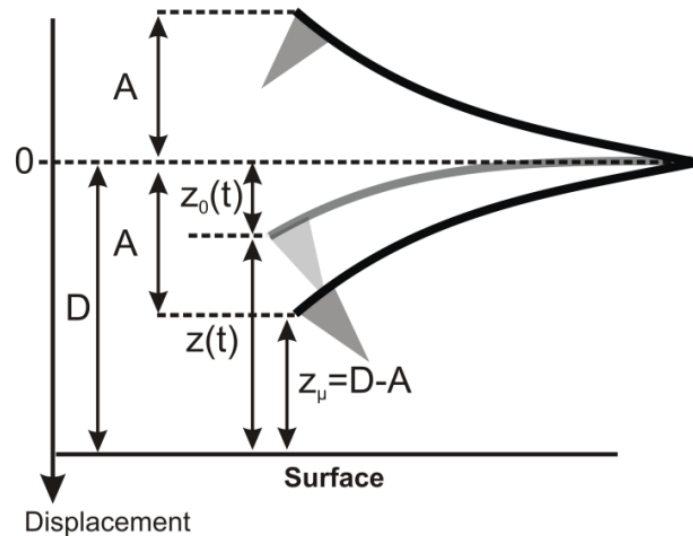

KPFM : concepts

- Attractive electrostatic force (empty capacitor) : capacitance gradient contribution

$$F_{\text{tip}}^{\text{el}} = +\frac{1}{2} \frac{\partial C(z)}{\partial z} [V_{\text{dc}} - V_{\text{CPD}} + V_{\text{ac}} \sin(2\pi f_{\text{mod}} t)]^2 \quad (\text{Eq.9})$$

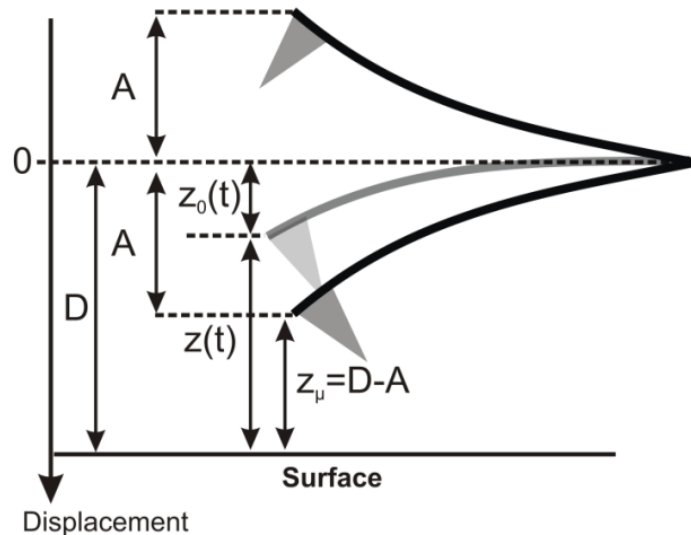

Parallel-plate capacitor approx. :

$$\begin{aligned} \frac{\partial C(z)}{\partial z} &= \frac{\partial}{\partial z} \left(\frac{K}{z(t)} \right) = -\frac{K}{z(t)^2} \\ &= -\frac{K}{[D - A_0 \sin(2\pi f_0 t)]^2} \end{aligned} \quad (\text{Eq.10})$$

KPFM : concepts

- Attractive electrostatic force (empty capacitor) : capacitance gradient contribution

$$F_{\text{tip}}^{\text{el}} = +\frac{1}{2} \frac{\partial C(z)}{\partial z} [V_{\text{dc}} - V_{\text{CPD}} + V_{\text{ac}} \sin(2\pi f_{\text{mod}} t)]^2 \quad (\text{Eq.9})$$

Time domain

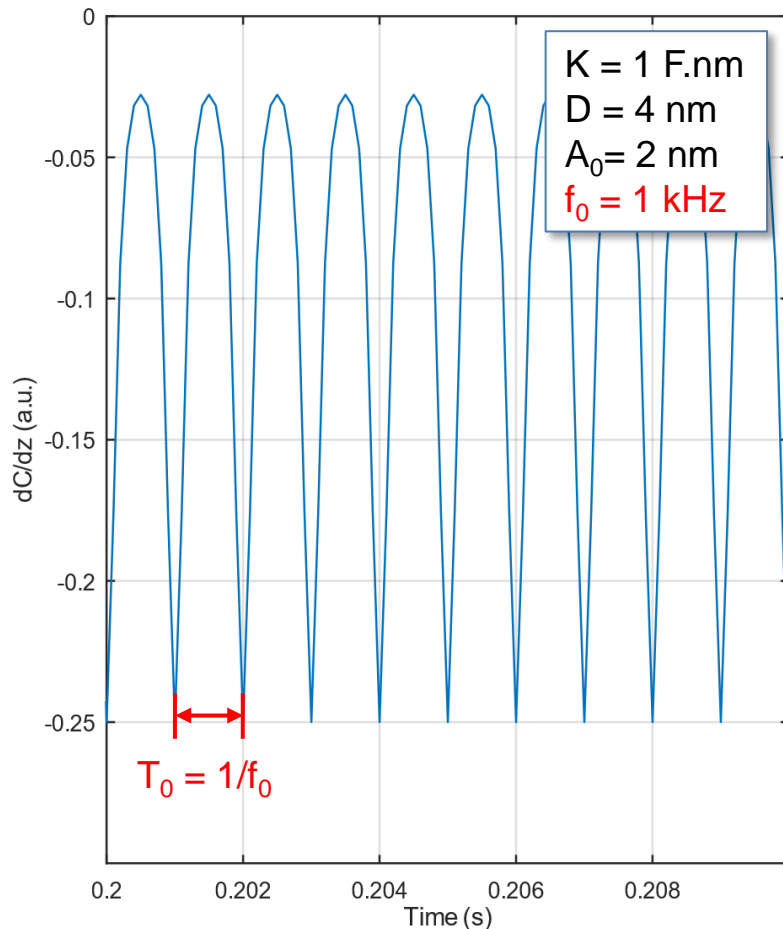

Frequency domain

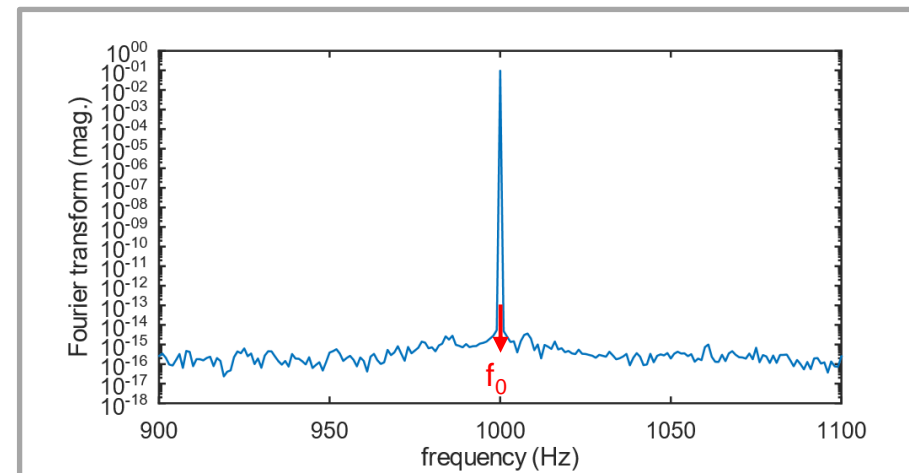
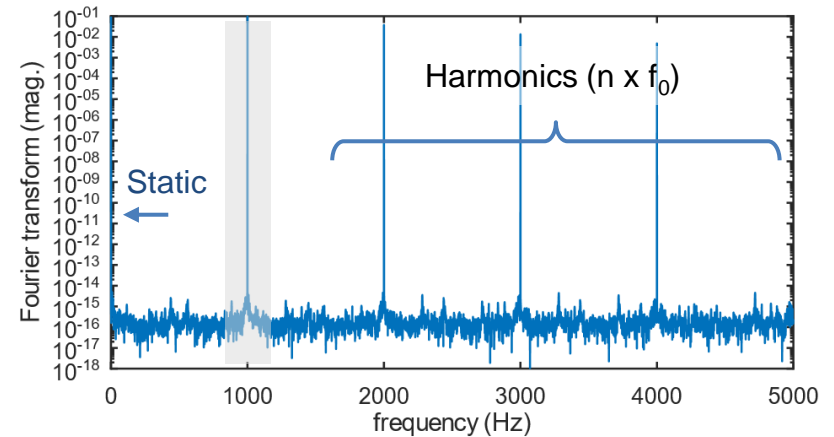

KPFM : concepts

□ Attractive electrostatic force (empty capacitor) : bias contribution

$$F_{\text{tip}}^{\text{el}} = + \frac{1}{2} \frac{\partial C(z)}{\partial z} [V_{\text{dc}} - V_{\text{CPD}} + V_{\text{ac}} \sin(2\pi f_{\text{mod}} t)]^2 \quad (\text{Eq.9})$$

Bias modulation-induced spectral components:

$$(Eq. 11a) \quad F_{\text{tip}}^{\text{el},0} = - \frac{\partial C(z)}{\partial z} \left[\frac{1}{2} (V_{\text{dc}} - V_{\text{CPD}})^2 + \frac{V_{\text{ac}}^2}{4} \right]$$

$$(Eq. 11b) \quad F_{\text{tip}}^{\text{el},f_{\text{mod}}} = - \frac{\partial C(z)}{\partial z} (V_{\text{dc}} - V_{\text{CPD}}) V_{\text{ac}} \sin(2\pi f_{\text{mod}} t)$$

$$(Eq. 11c) \quad F_{\text{tip}}^{\text{el},2f_{\text{mod}}} = \frac{\partial C(z)}{\partial z} \frac{V_{\text{ac}}^2}{4} \cos(2f_{\text{mod}} t)$$

Frequency domain

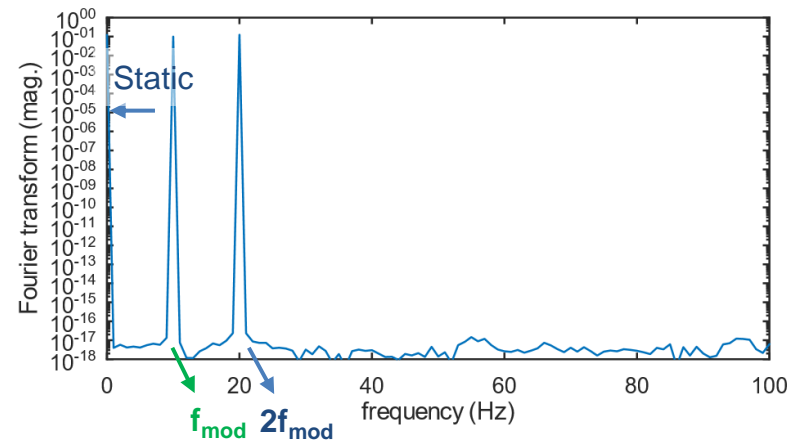
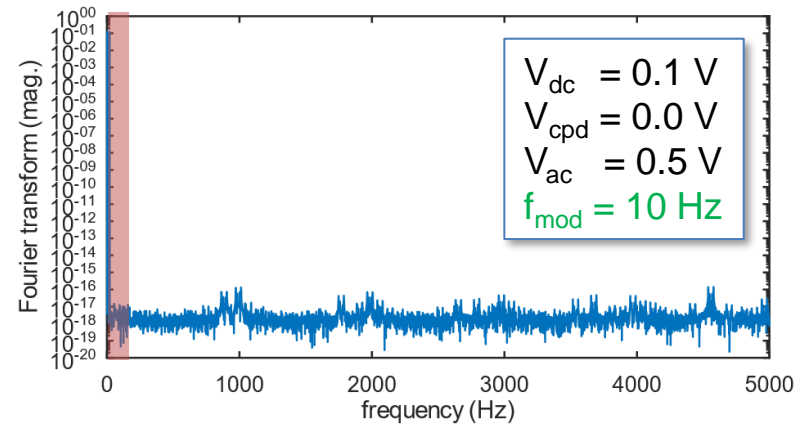

KPFM : concepts

□ Attractive electrostatic force (empty capacitor) : complete expression

$$F_{\text{tip}}^{\text{el}} = +\frac{1}{2} \frac{\partial C(z)}{\partial z} [V_{\text{dc}} - V_{\text{CPD}} + V_{\text{ac}} \sin(2\pi f_{\text{mod}} t)]^2 \quad (\text{Eq.9})$$

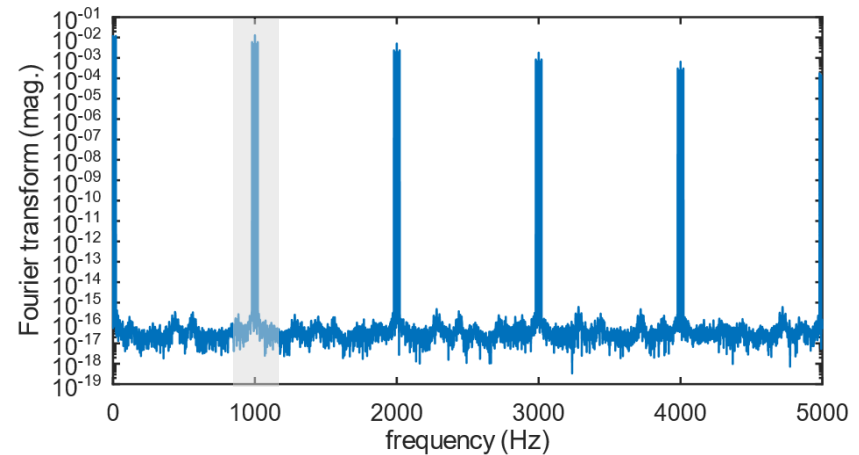
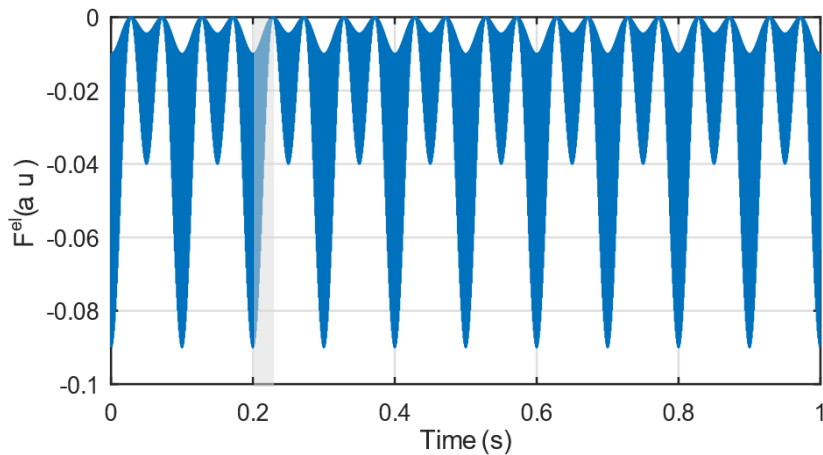

Frequency mixing: side-bands

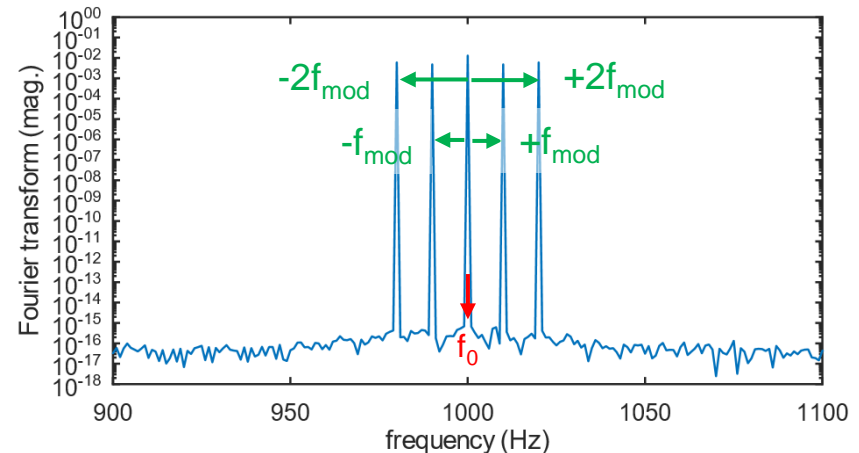
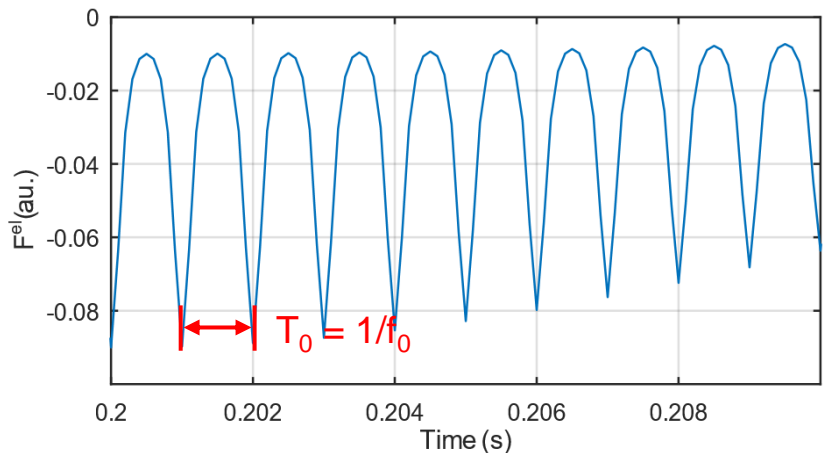

KPFM : concepts

- ❑ **Static deflection & modulation at $(f_0 \pm f_{mod})$ and $(f_0 \pm 2f_{mod})$ of the cantilever** (convolution with the cantilever transfer function however): *side bands*

- ❑ **The f_{mod} & $(f_0 \pm f_{mod})$ force components are proportional to $(V_{dc} - V_{CPD})$:** the KPFM aims at detecting and nullifying these by providing the proper dc voltage that matches the “CPD”

- ❑ **F^{el} is superimposed to the non bias-dependant interaction forces** (additive process, no further mixing) that are f_0 -modulated (cantilever motion)

KPFM : concepts

□ Illustration : No CPD compensation

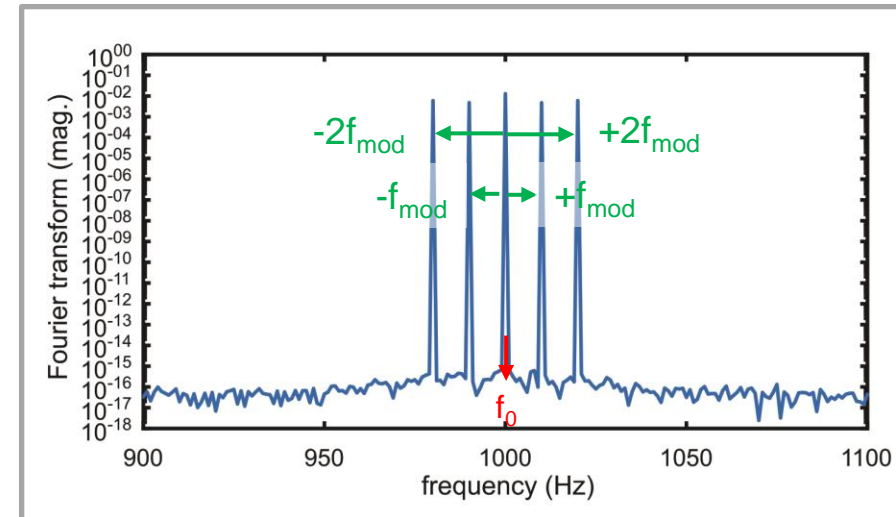
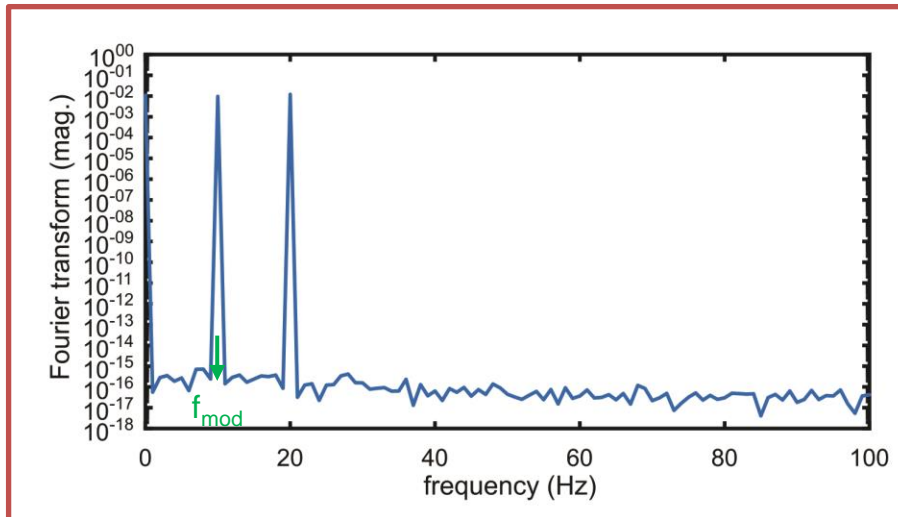
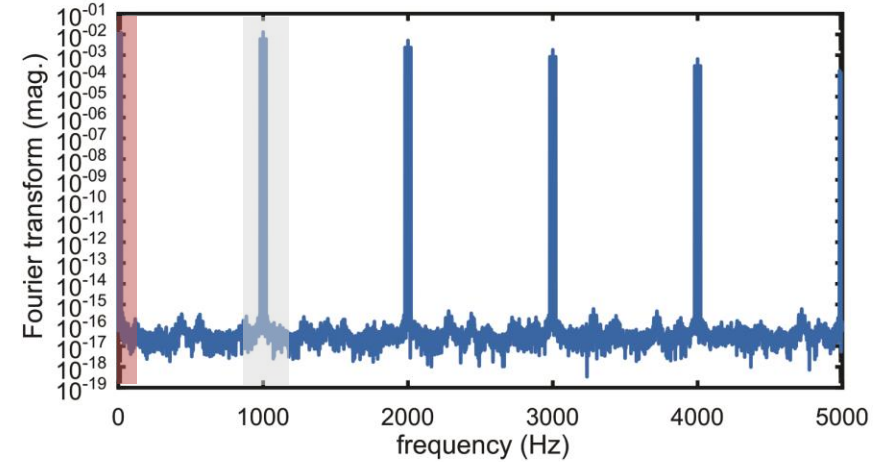
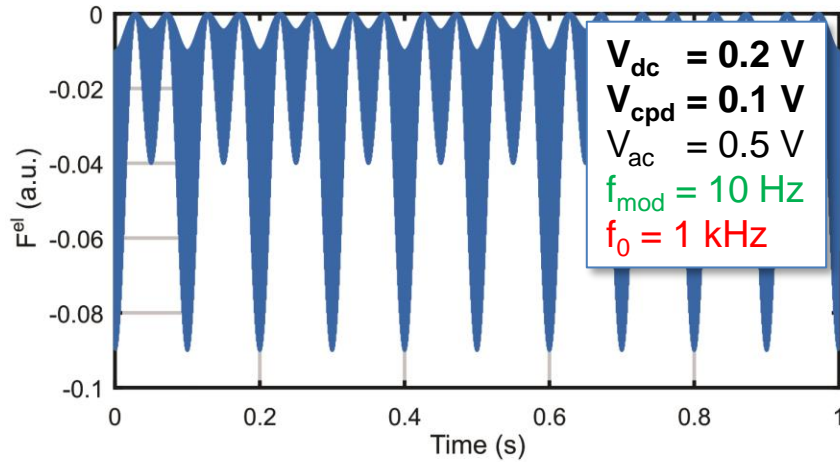

KPFM : concepts

□ Illustration : CPD compensation

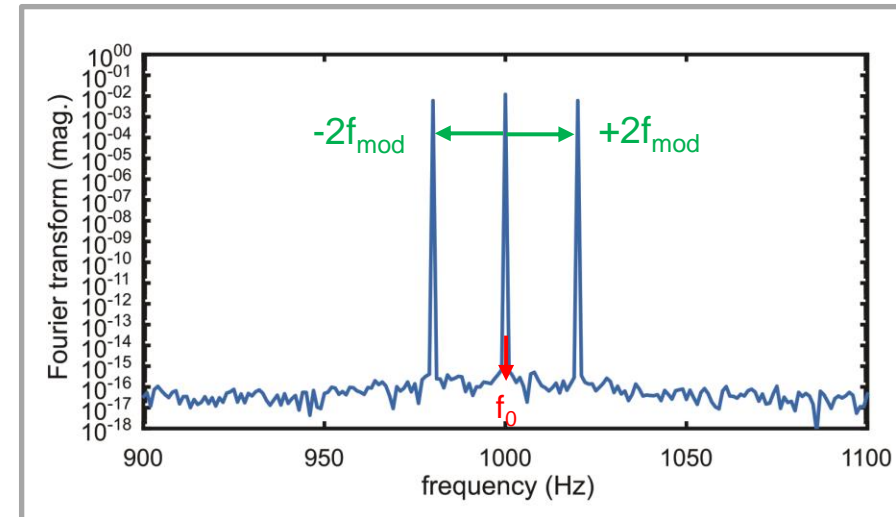
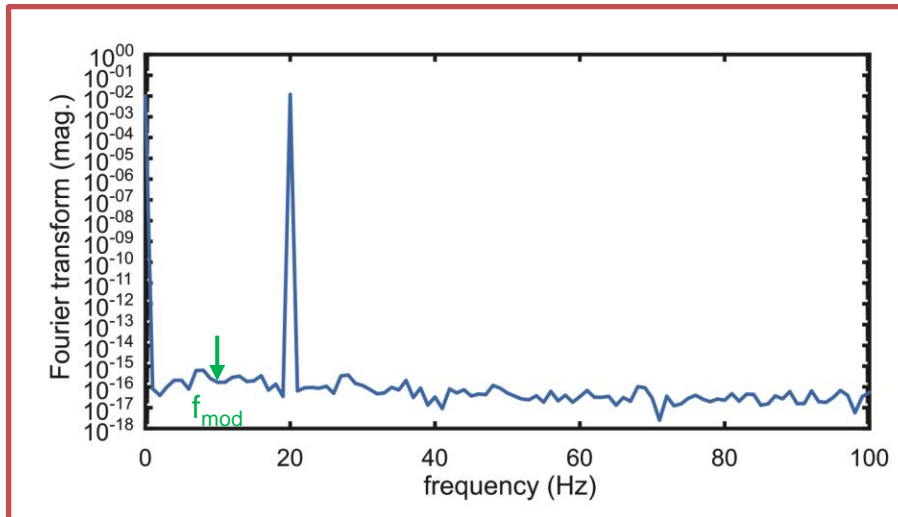
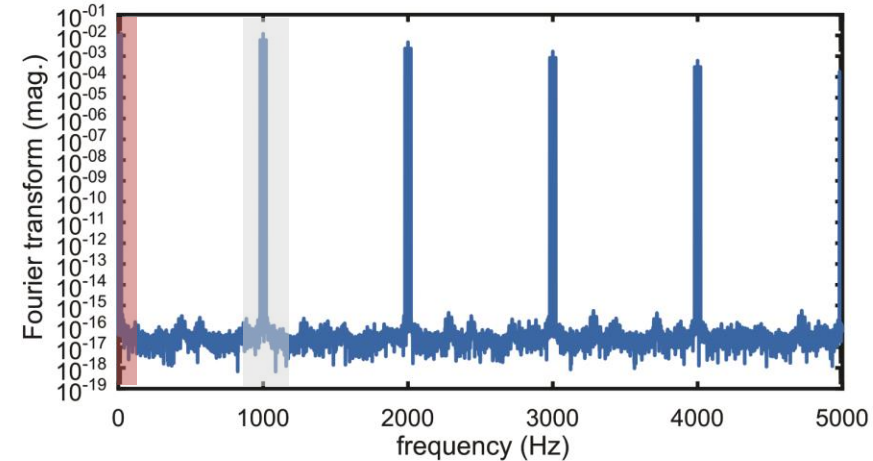
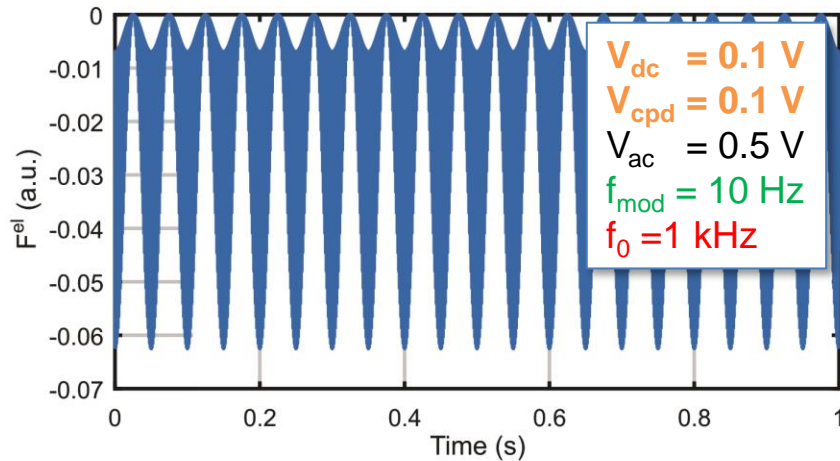

KPFM : concepts

□ Experimental illustration* ($f_0 = 150.9$ kHz, $f_{\text{mod}} = 2$ kHz) :

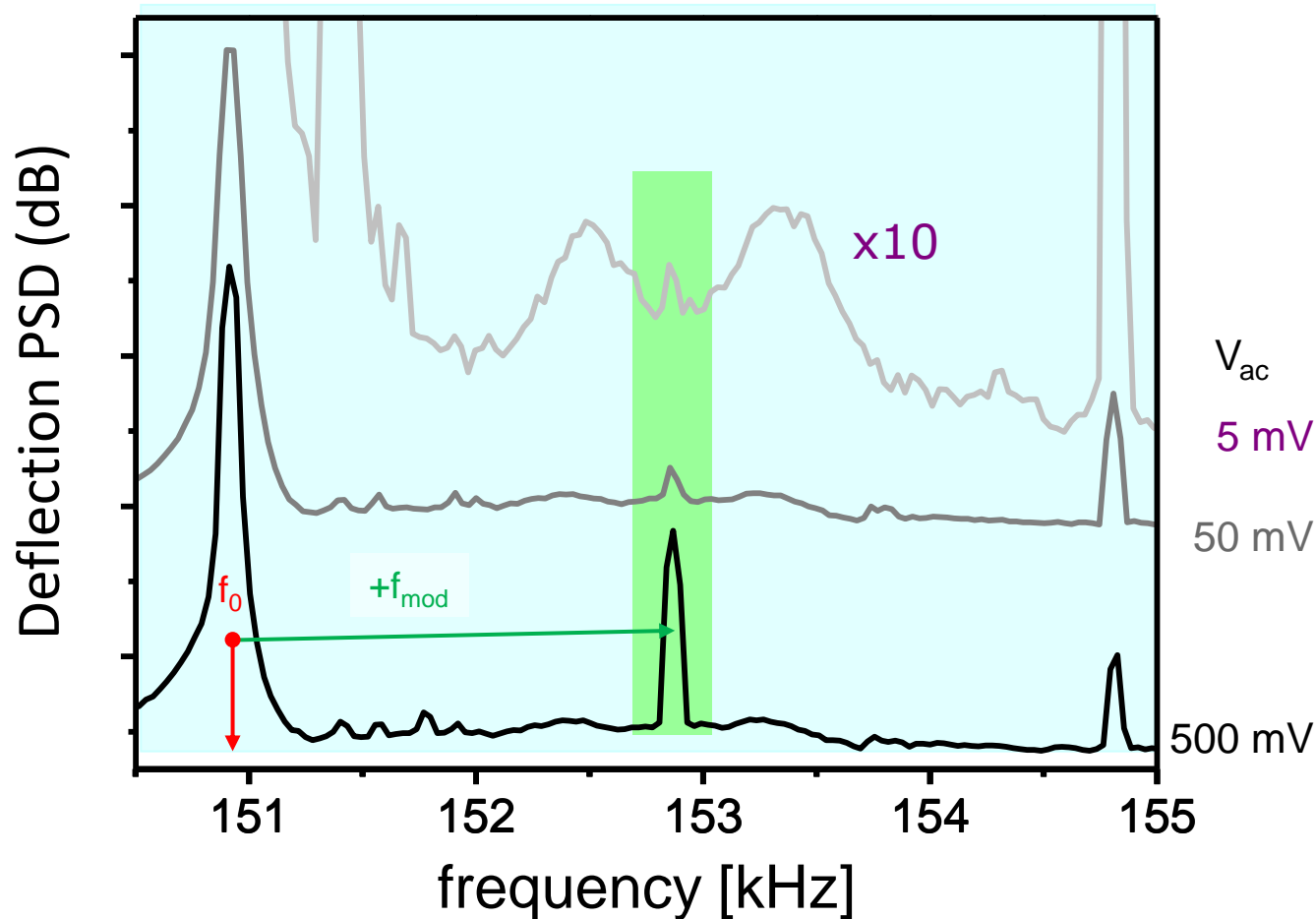

*U.Zerweck *et al.*, Phys. Rev. B 71, 125424 (2005)

KPFM: implementations

Cantilever deflection spectrum upon V_{bias} modulation...
(f_0 harmonics not shown)

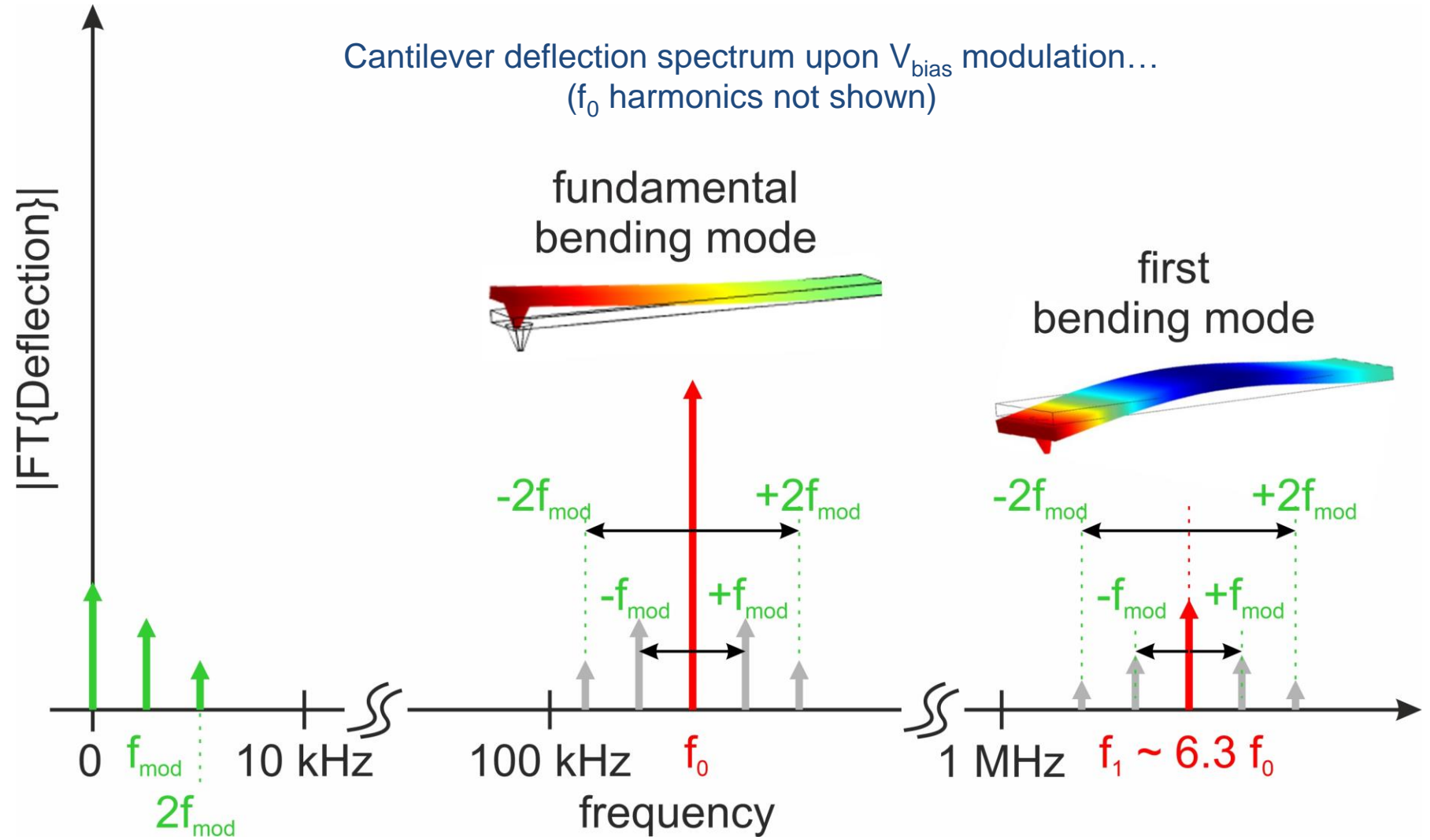

1a- Frequency Modulation-KPFM (nc-AFM)

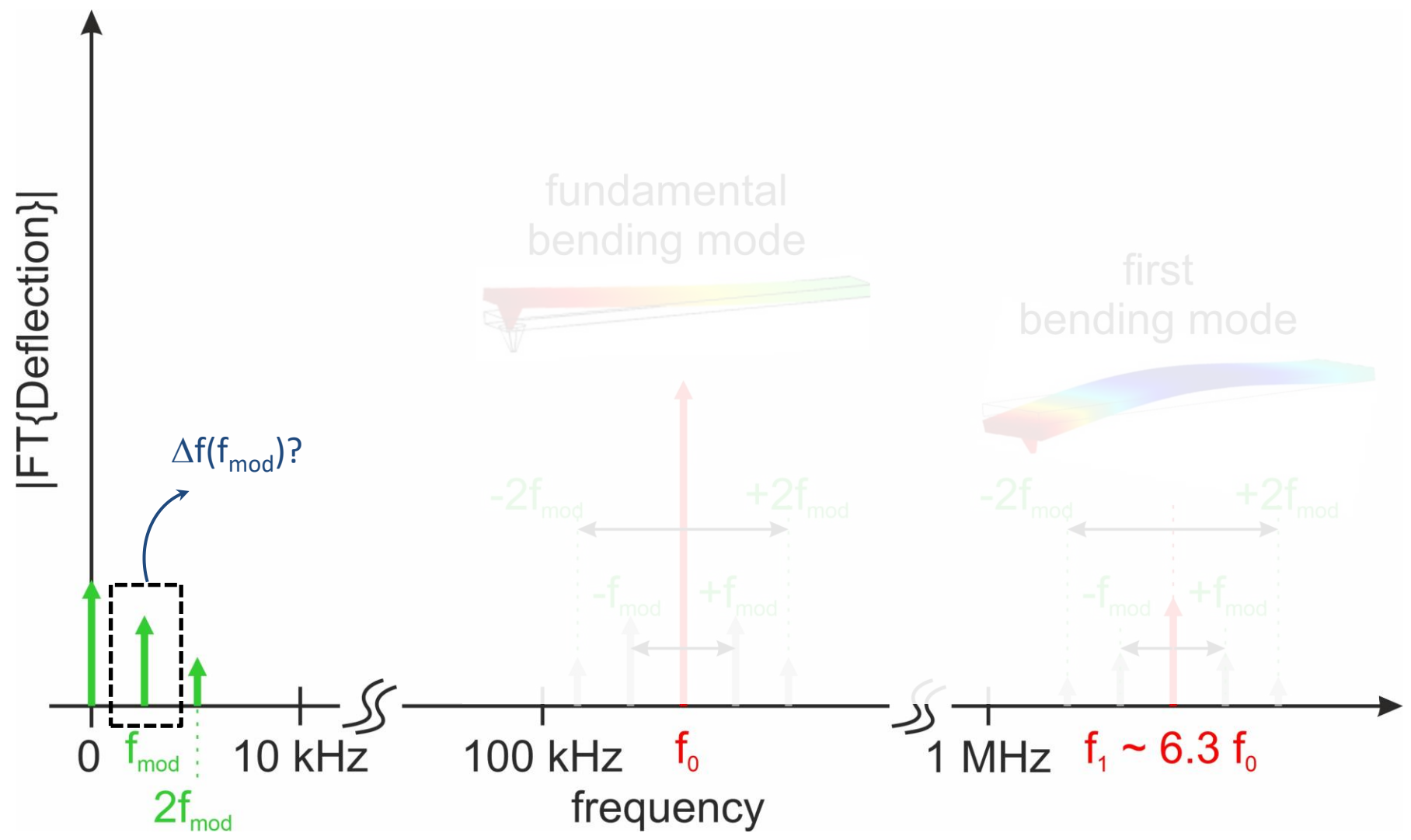

1a- Frequency Modulation-KPFM (nc-AFM)

- Forces (incl. \mathbf{F}^{el}) \rightarrow shift of the resonance :

1st order :
$$f'_0 = \frac{1}{2\pi} \sqrt{\frac{k - \partial F / \partial z}{m^*}} \approx f_0 \left(1 - \frac{1}{2k} \frac{\partial F}{\partial z} \right)$$
 (Eq.12)

- Bias modulation (f_{mod}) \rightarrow \mathbf{F}^{el} modulation (f_{mod}) \rightarrow Δf modulation (f_{mod})

- ✓ $\Delta f = f(V_b^2)$
- ✓ FM-KPFM is sensitive to the electrostatic force gradient
- ✓ As for $\mathbf{F}^{\text{el}}(f_{\text{mod}})$, $\Delta f(f_{\text{mod}}) = 0$ as soon as $V_{\text{dc}} = V_{\text{cdp}}$

1a- Frequency Modulation-KPFM (nc-AFM)

- Forces (incl. F^{el}) \rightarrow shift of the resonance :

1st order :

$$f'_0 = \frac{1}{2\pi} \sqrt{\frac{k - \partial F / \partial z}{m^*}} \approx f_0 \left(1 - \frac{1}{2k} \frac{\partial F}{\partial z} \right)$$

(Eq.12)

- Bias modulation (f_{mod}) \rightarrow F^{el} modulation (f_{mod}) \rightarrow Δf modulation (f_{mod})

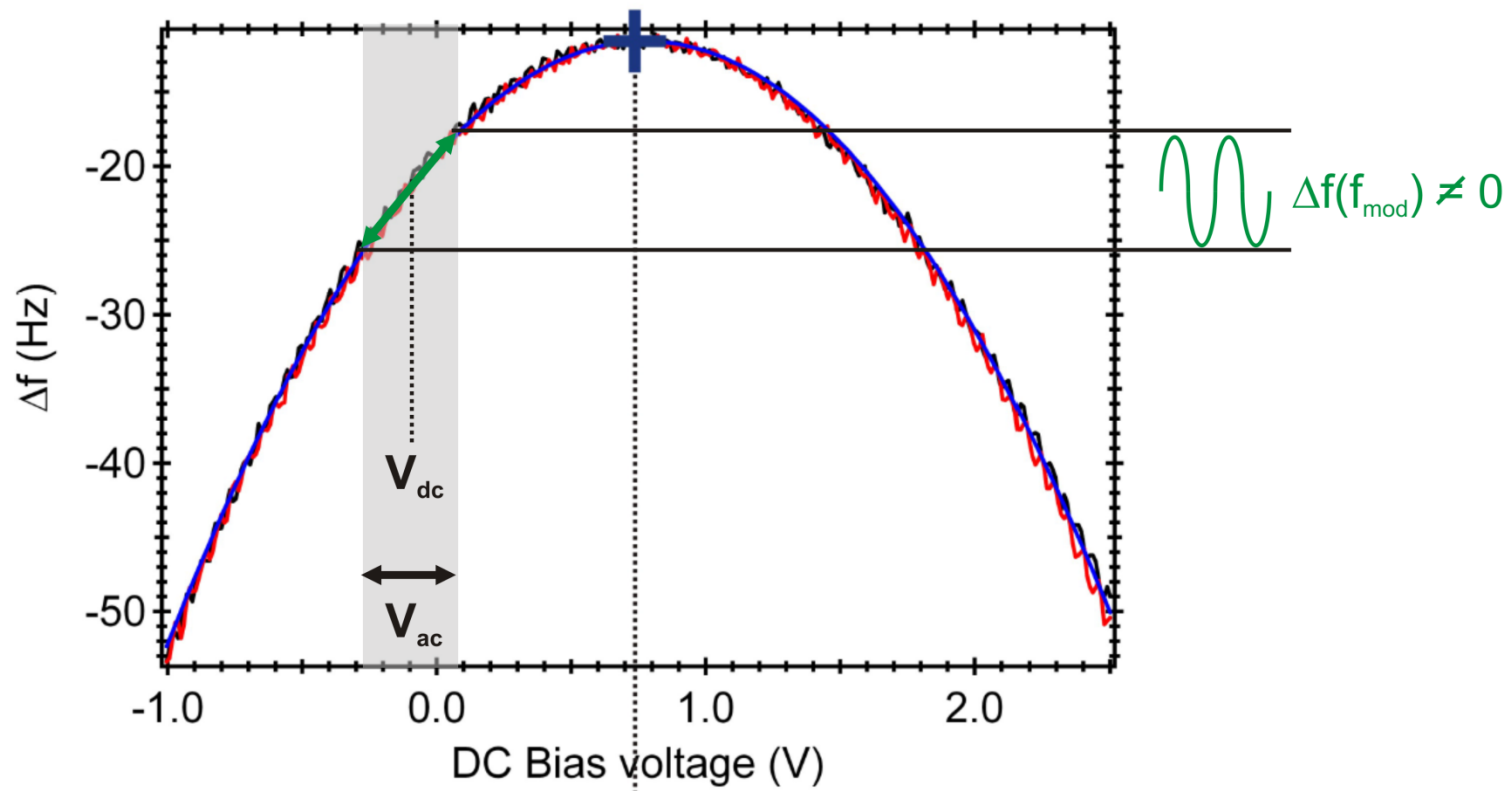

1a- Frequency Modulation-KPFM (nc-AFM)

- Forces (incl. F^{el}) \rightarrow shift of the resonance :

1st order :

$$f'_0 = \frac{1}{2\pi} \sqrt{\frac{k - \partial F / \partial z}{m^*}} \approx f_0 \left(1 - \frac{1}{2k} \frac{\partial F}{\partial z} \right)$$

(Eq.12)

- Bias modulation (f_{mod}) \rightarrow F^{el} modulation (f_{mod}) \rightarrow Δf modulation (f_{mod})

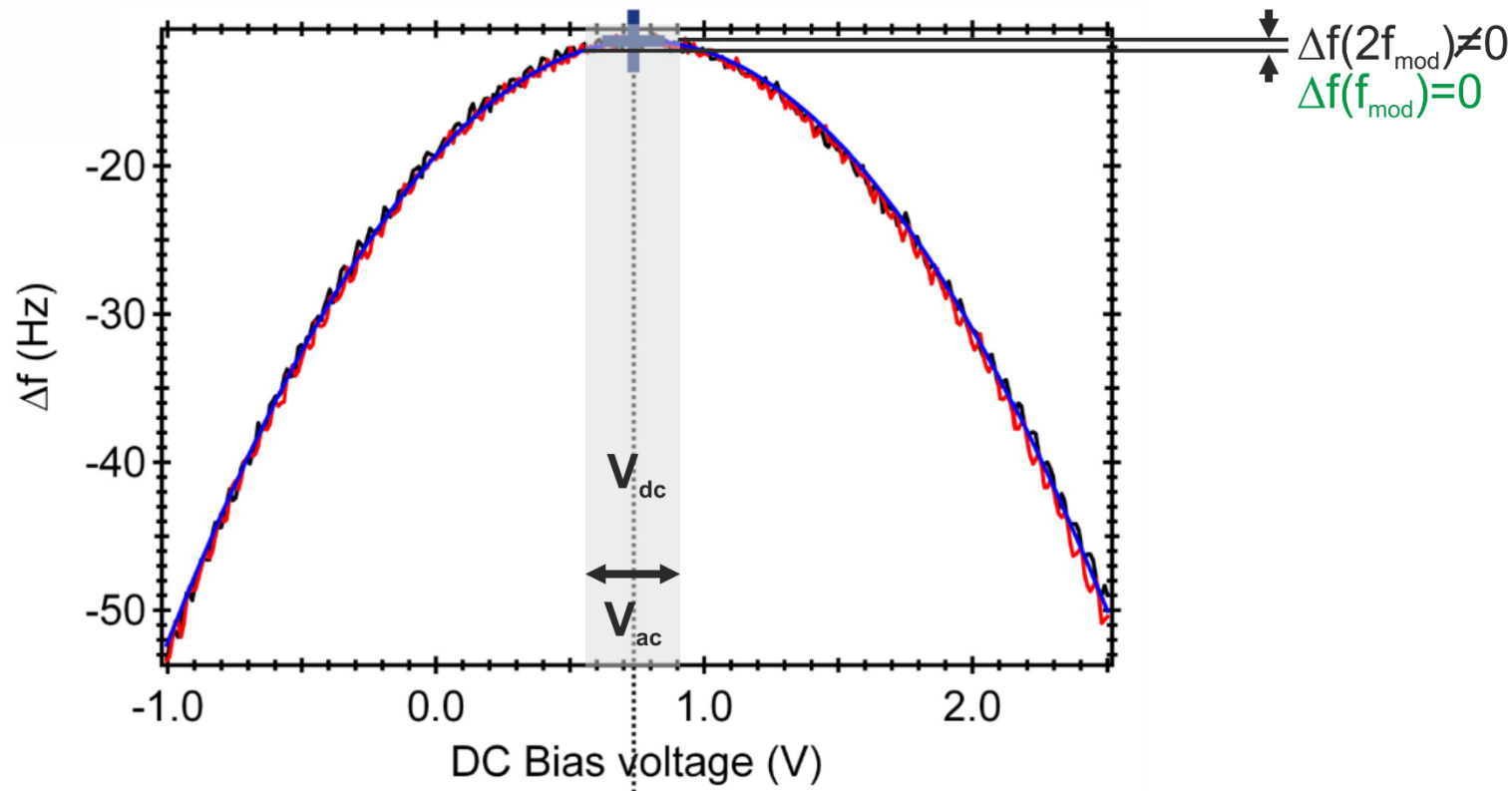

1a- Frequency Modulation-KPFM (nc-AFM)

- Forces (incl. F^{el}) \rightarrow shift of the resonance :

1st order :

$$f'_0 = \frac{1}{2\pi} \sqrt{\frac{k - \partial F / \partial z}{m^*}} \approx f_0 \left(1 - \frac{1}{2k} \frac{\partial F}{\partial z} \right)$$

(Eq.12)

- Bias modulation (f_{mod}) \rightarrow F^{el} modulation (f_{mod}) \rightarrow Δf modulation (f_{mod})

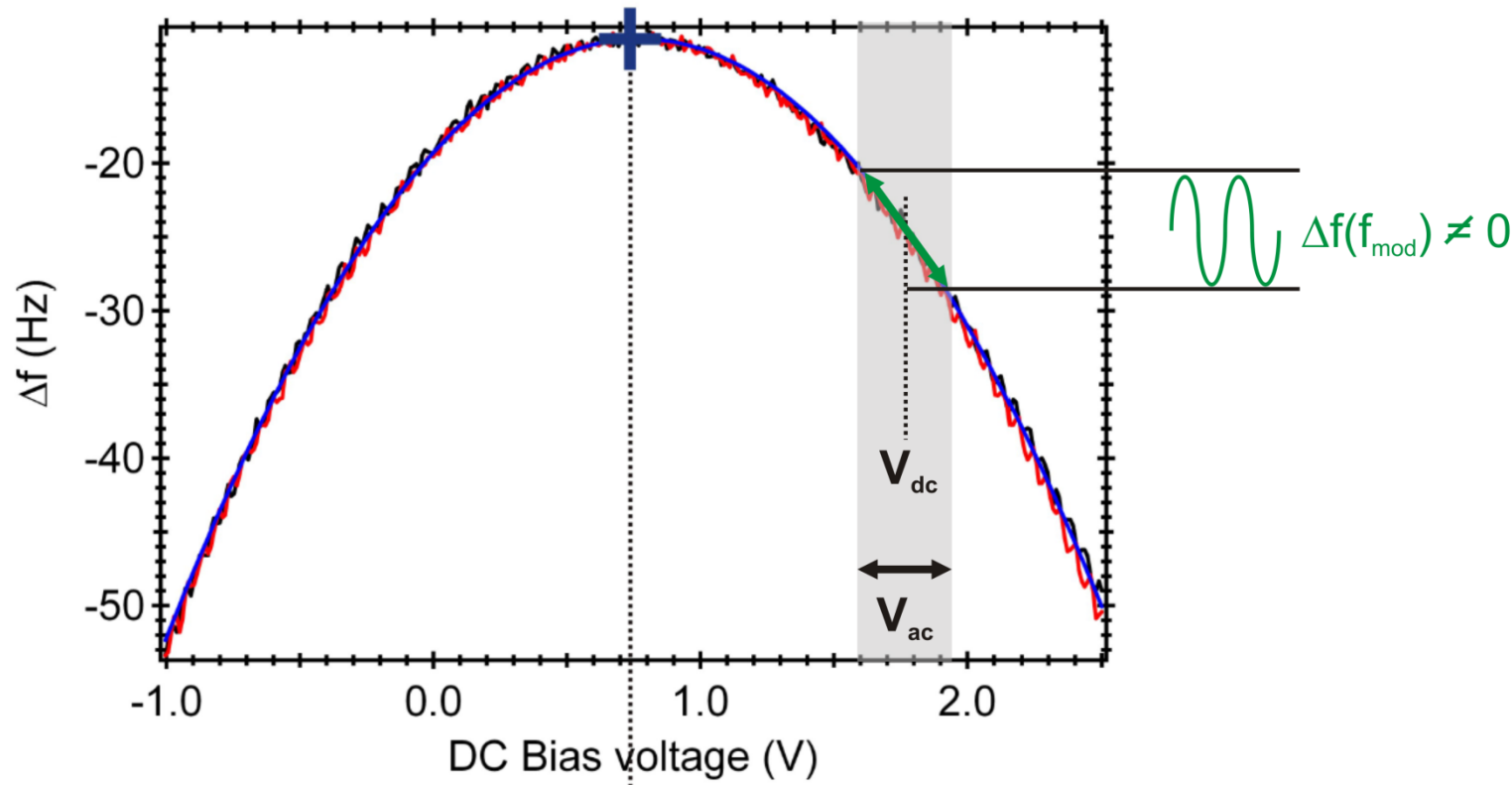

1a- Frequency Modulation-KPFM (nc-AFM)

- Schematically :

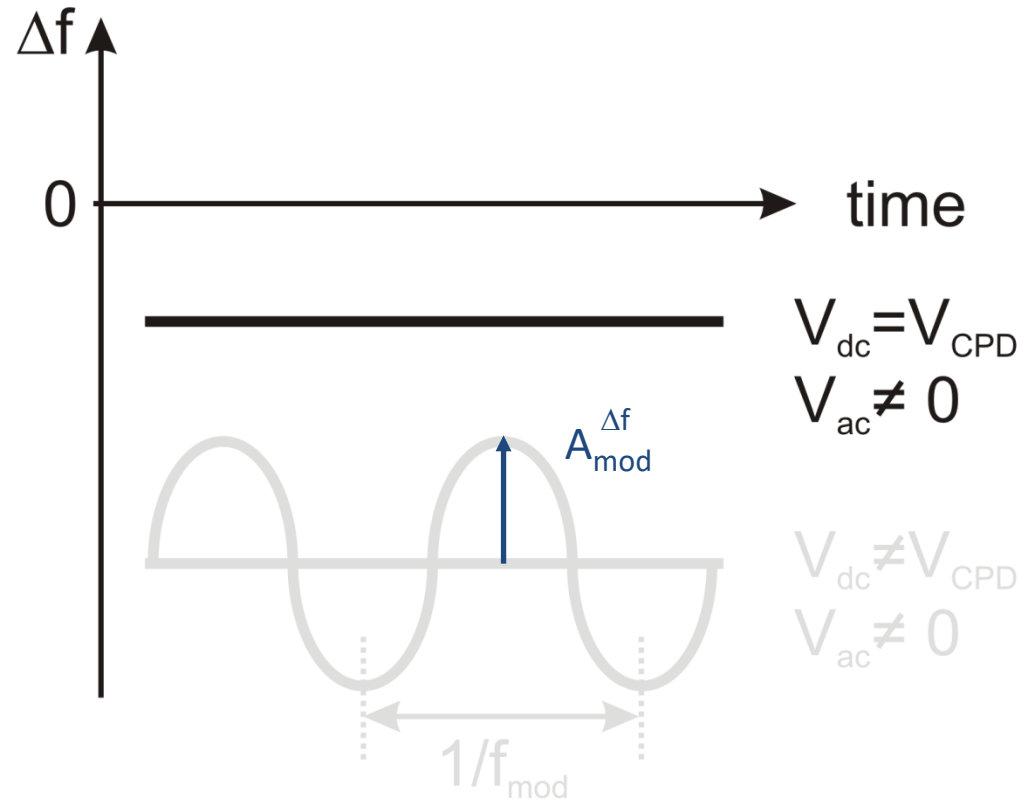

1a- Frequency Modulation-KPFM: experimental setup

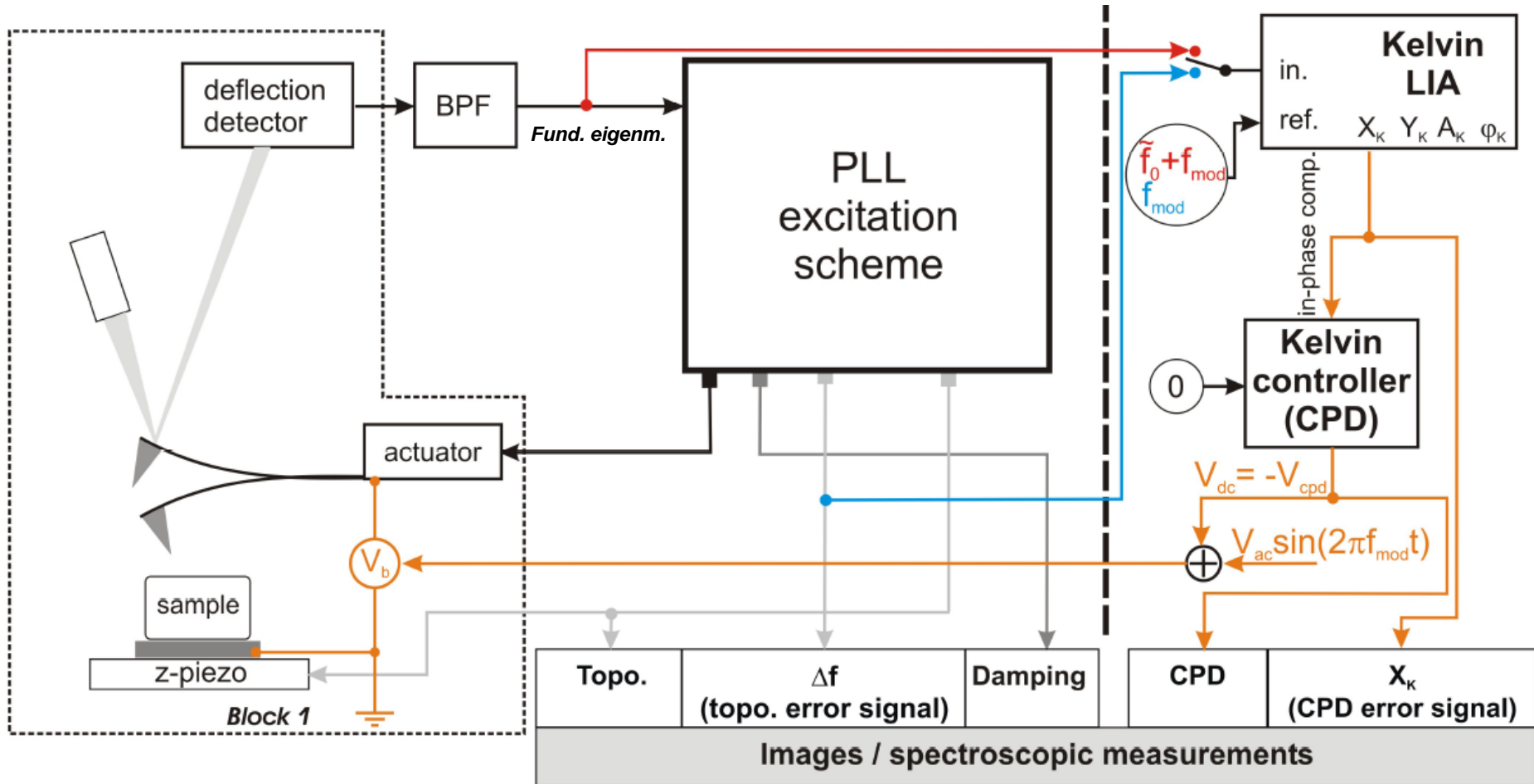

1a- Frequency Modulation-KPFM: experimental setup

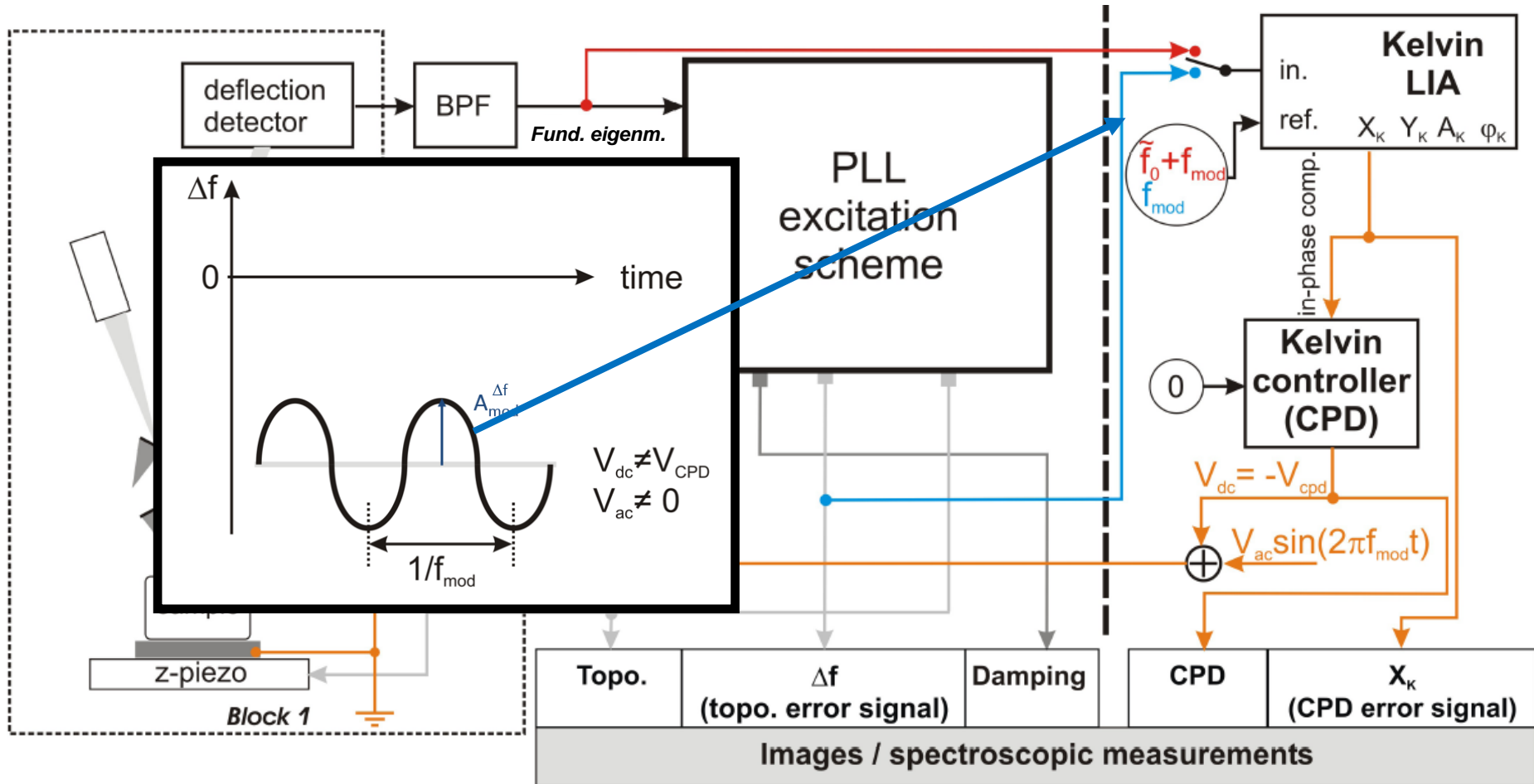

1a- Frequency Modulation-KPFM: experimental setup

□ Data from Th. Glatzel (E.Meyer's group, Basel) in [1]:

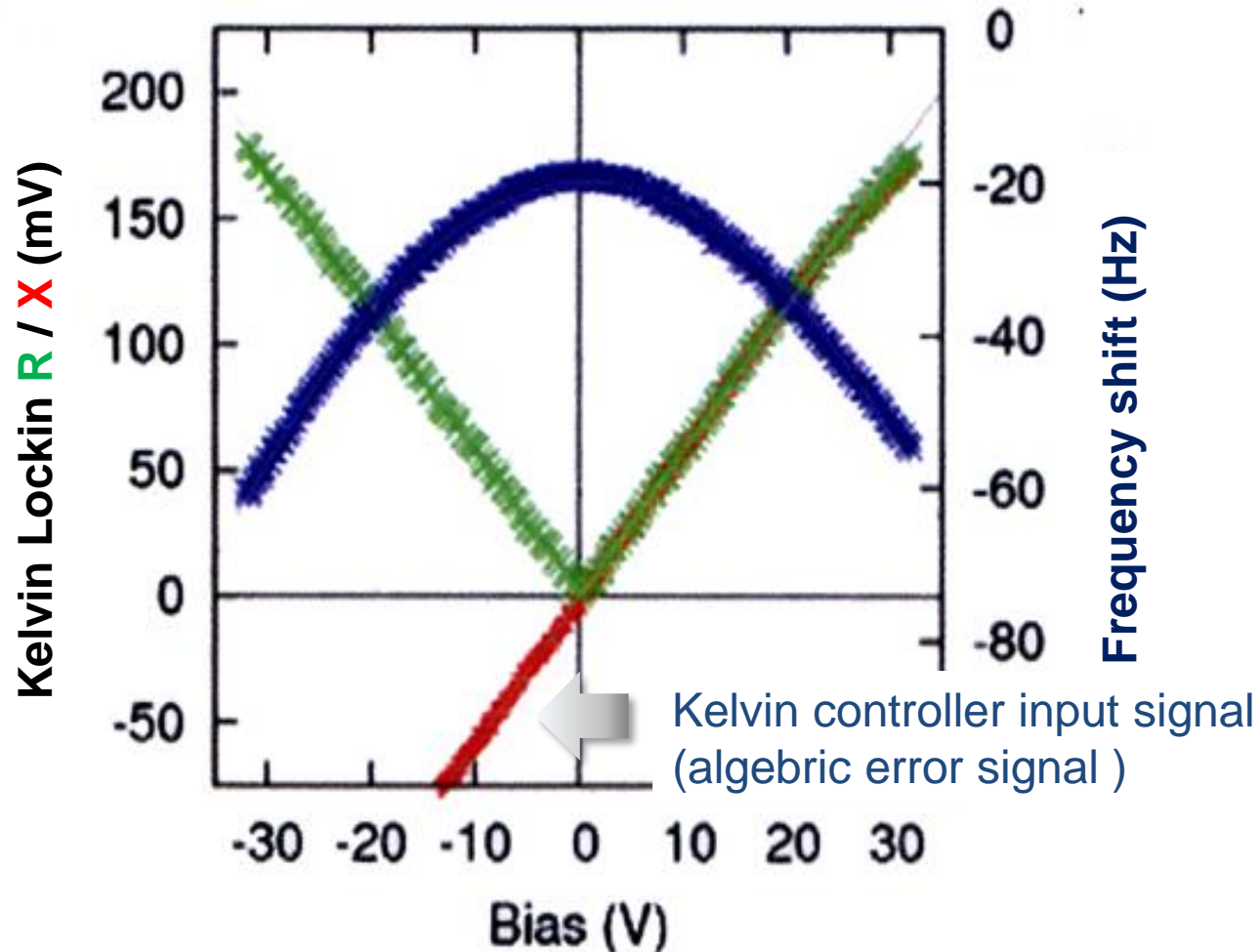

¹Kelvin Probe Force Microscopy, *Measuring & Compensating Electrostatic forces*, Springer Series in Surface Sciences (Th. Glatzel & S. Sadewasser Ed.)

1a- Frequency Modulation-KPFM: temporal considerations

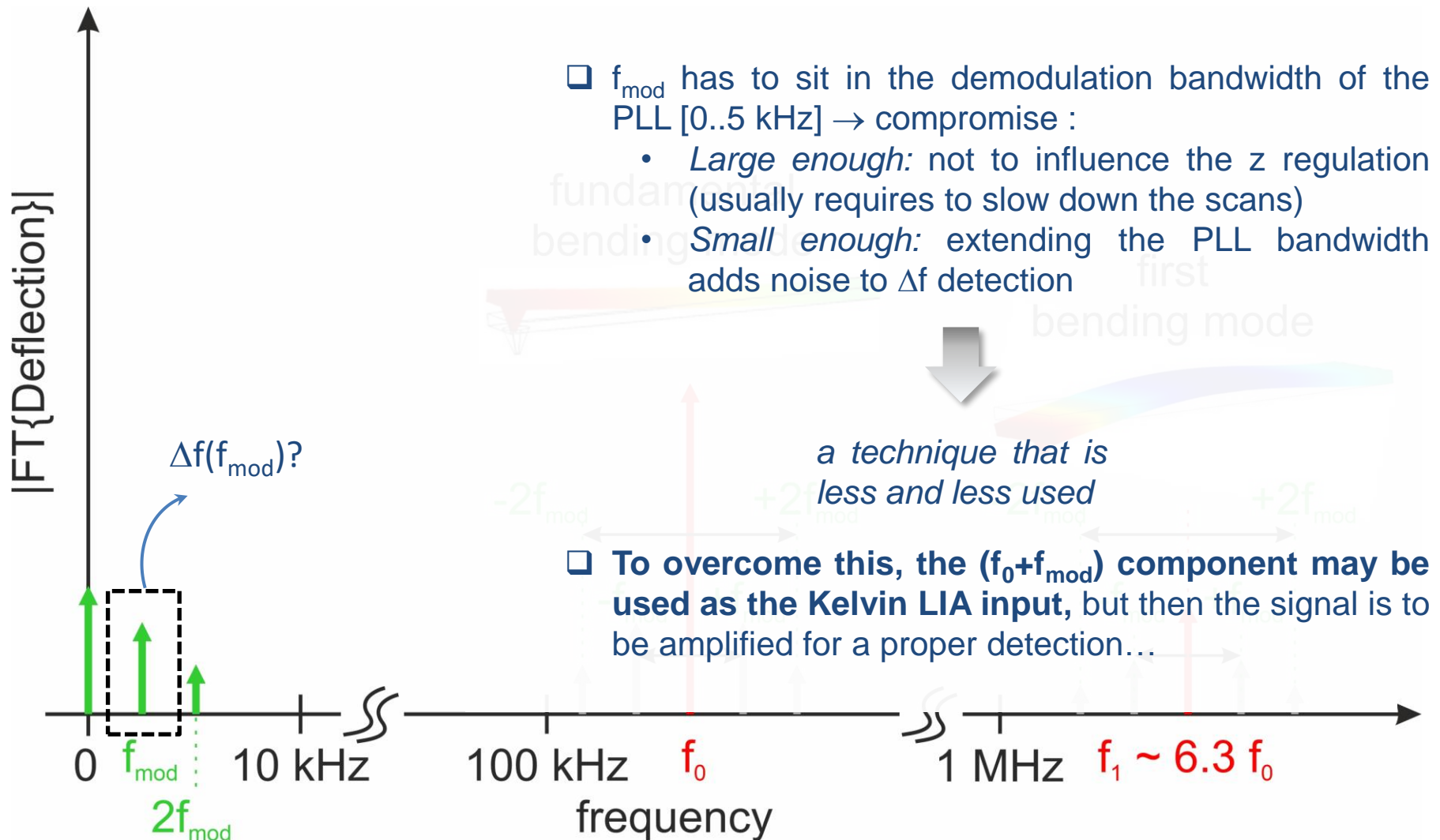

1b- Side-bands FM-KPFM

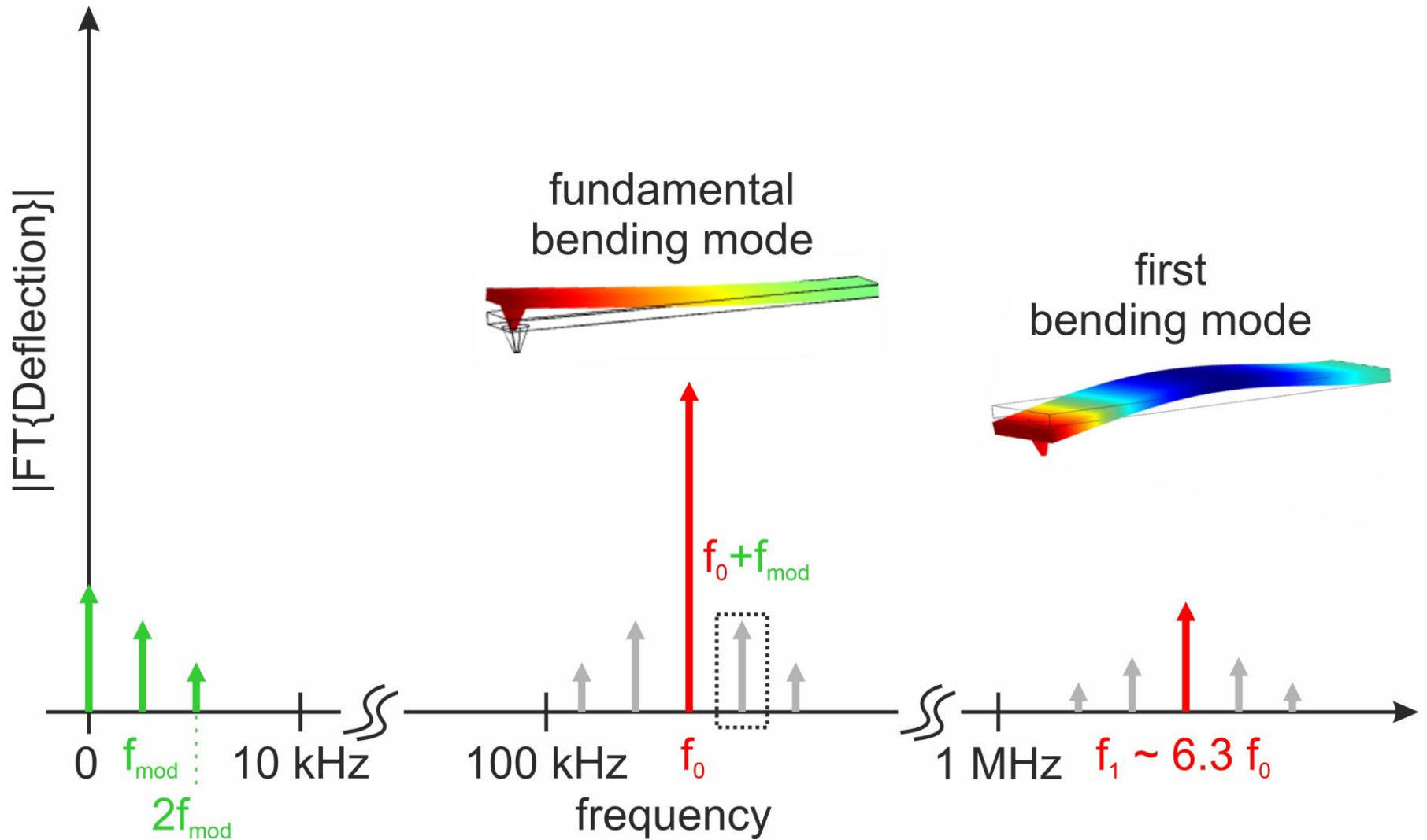

1b- Side-bands FM-KPFM: experimental setup

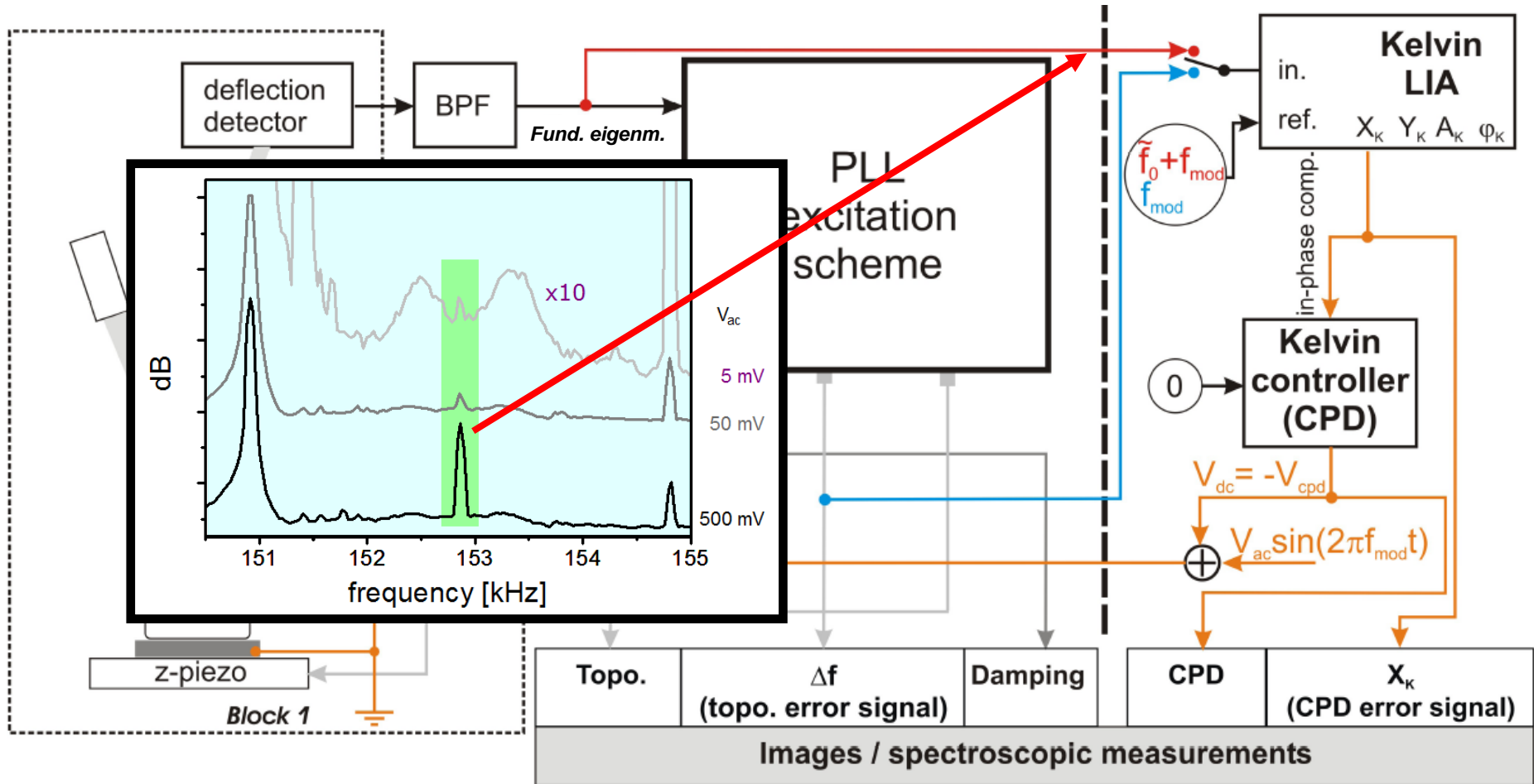

1b- Side-bands FM-KPFM

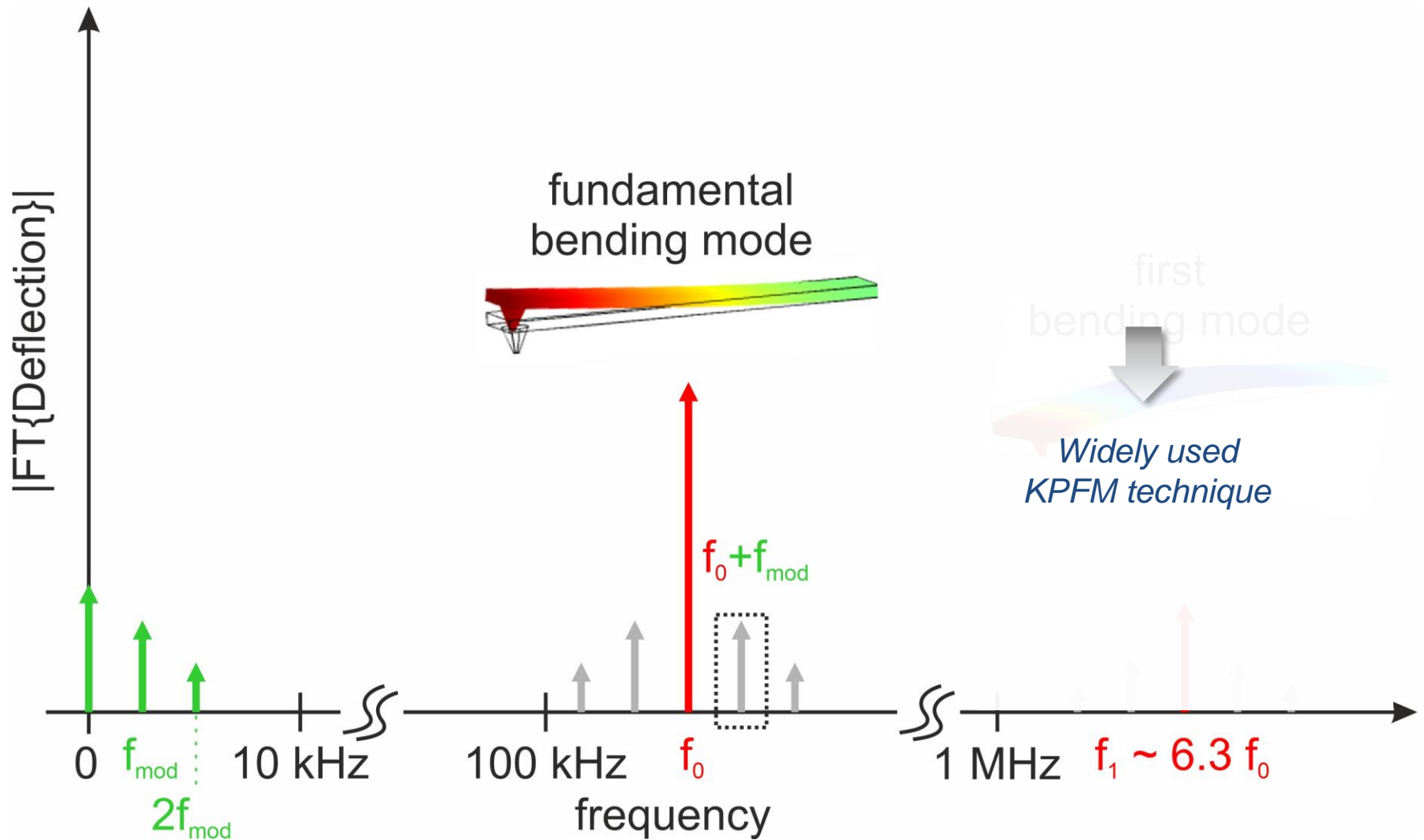

2- Amplitude-Modulation KPFM:

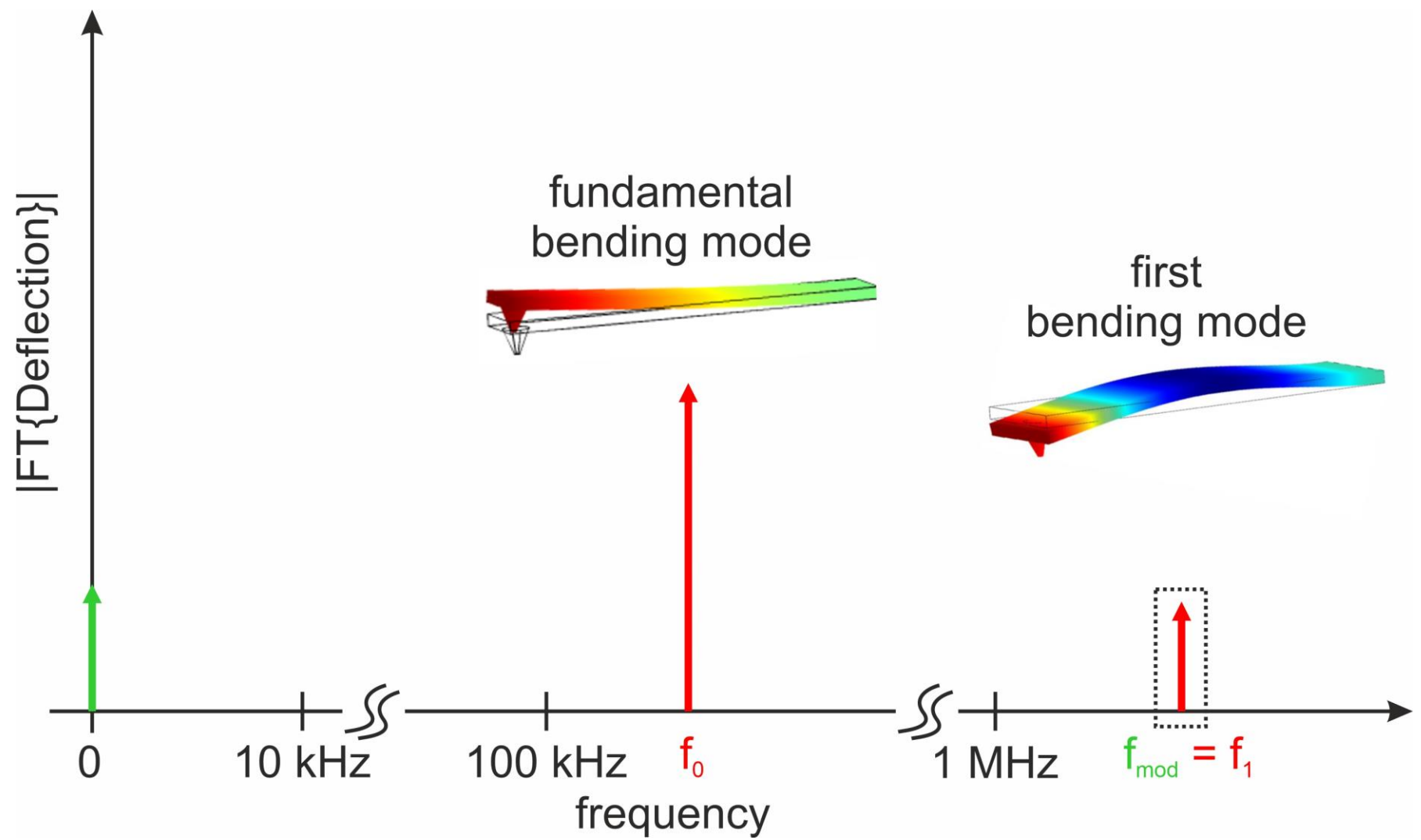

2- Amplitude-Modulation KPFM: experimental setup

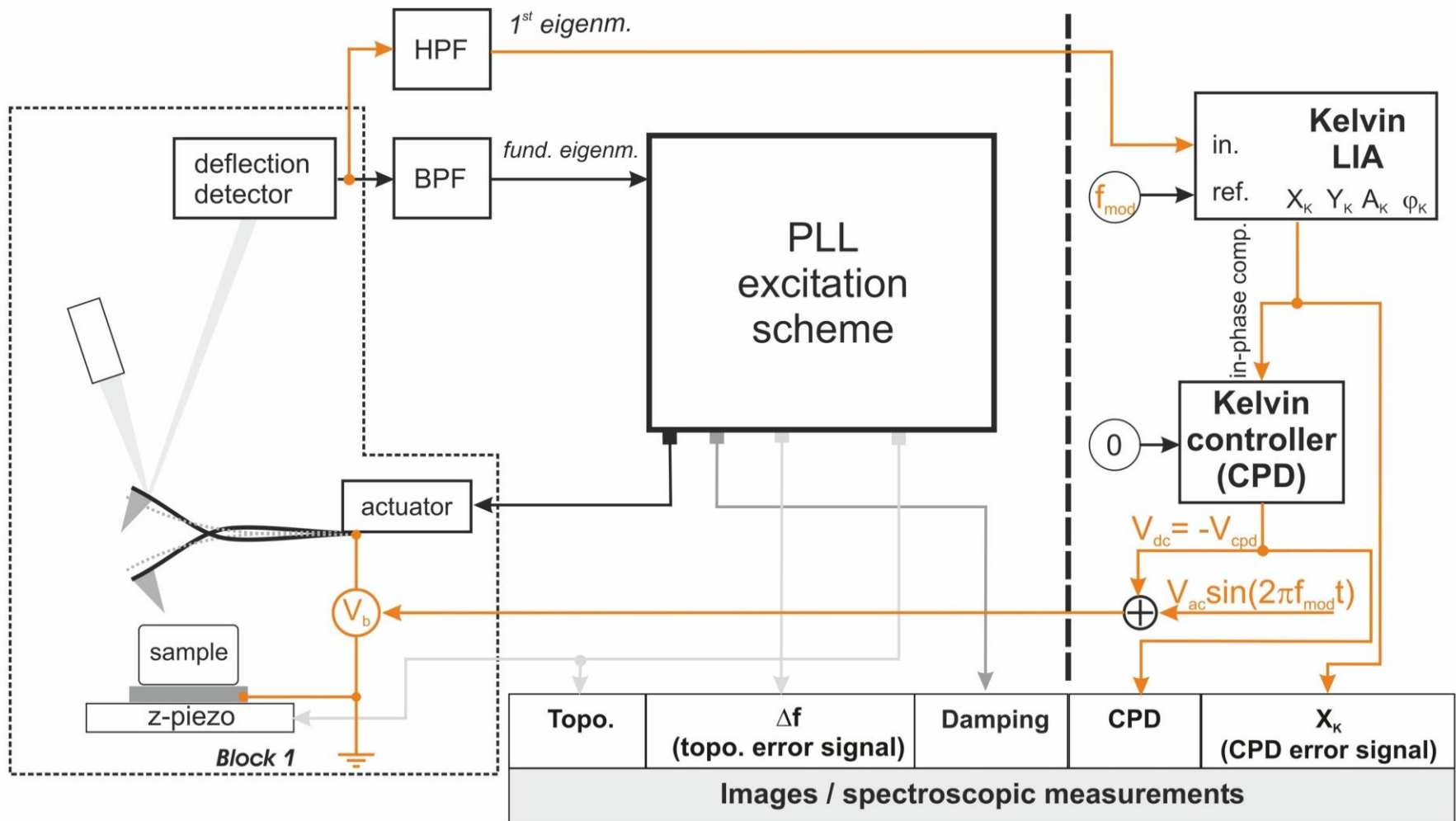

2- Amplitude-Modulation KPFM:

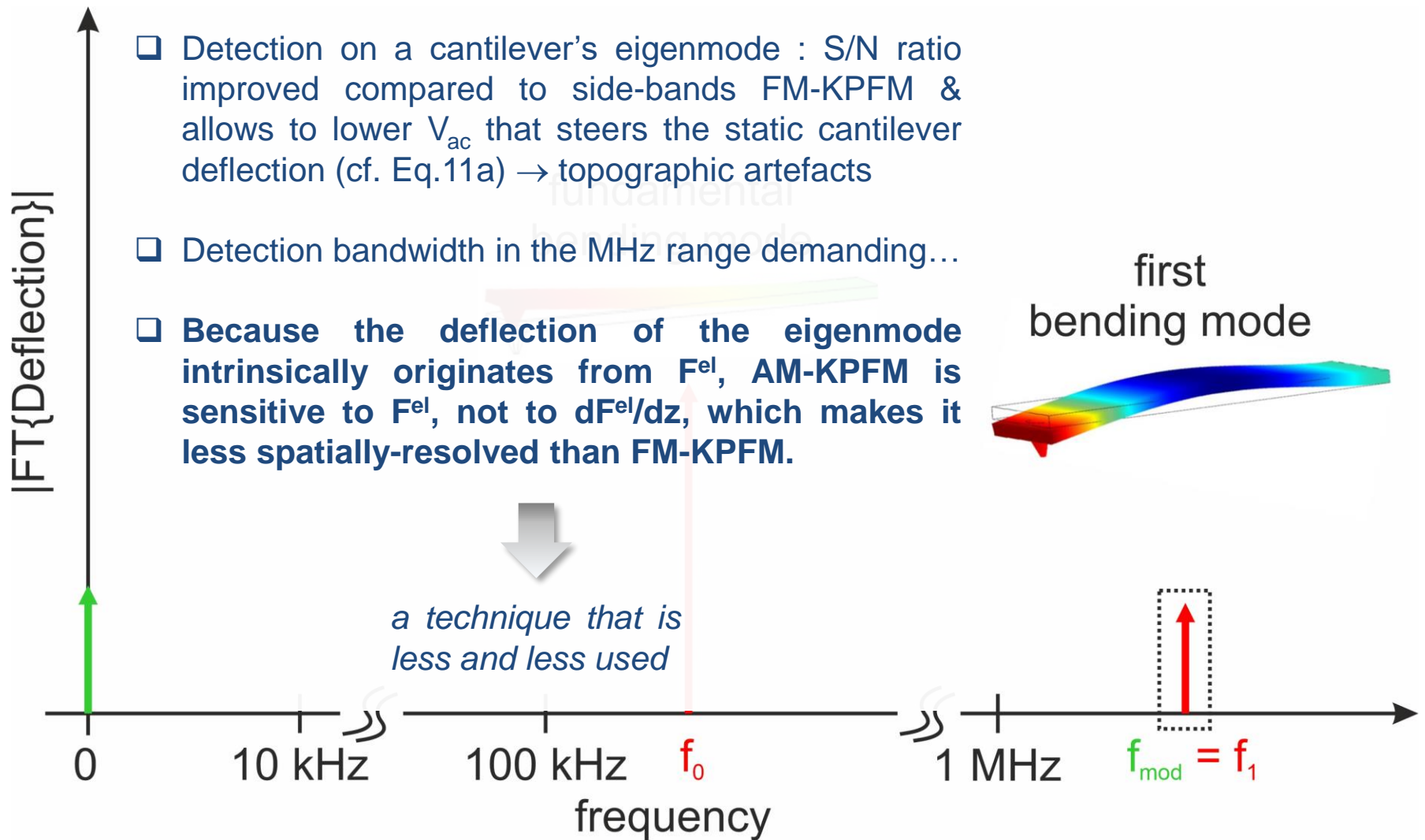

PHYSICAL REVIEW B 86, 075407 (2012)

Multiscale approach for simulations of Kelvin probe force microscopy with atomic resolution

Ali Sadeghi, Alexis Baratoff, S. Alireza Ghasemi, Stefan Goedecker, Thilo Glatzel, Shigeki Kawai, and Ernst Meyer

Department of Physics, University of Basel, Klingelbergstrasse 82, CH-4056 Basel, Switzerland

(Received 23 March 2012; revised manuscript received 21 June 2012; published 2 August 2012)

The distance dependence and atomic-scale contrast recently observed in nominal contact potential difference (CPD) signals simultaneously recorded by Kelvin probe force microscopy (KPFM) using noncontact atomic force microscopy (NCAFM) on defect-free surfaces of insulating as well as semiconducting samples have stimulated theoretical attempts to explain such effects. Especially in the case of insulators, it is not quite clear how the applied bias voltage affects electrostatic forces acting on the atomic scale. We attack this problem in two steps. First, the electrostatics of the macroscopic tip-cantilever-sample system is treated by a finite-difference method on an adjustable nonuniform mesh. Then the resulting electric field under the tip apex is inserted into a series of atomistic wavelet-based density functional theory (DFT) calculations. Results are shown for a realistic neutral but reactive silicon nanoscale tip interacting with a NaCl(001) sample. Bias-dependent forces and resulting atomic displacements are computed to within an unprecedented accuracy. Theoretical expressions for amplitude modulation (AM) and frequency modulation (FM) KPFM signals and for the corresponding local contact potential differences (LCPD) are obtained by combining the macroscopic and atomistic contributions to the electrostatic force component generated at the voltage modulation frequency, and evaluated for several tip oscillation amplitudes A up to 10 nm. For $A = 0.1 \text{ \AA}$, the computed LCPD contrast is proportional to the slope of the atomistic force versus bias in the AM mode and to its derivative with respect to the tip-sample separation in the FM mode. Being essentially constant over a few volts, this slope is the basic quantity that determines variations of the atomic-scale LCPD contrast. Already above $A = 1 \text{ \AA}$, the LCPD contrasts in both modes exhibit almost the same spatial dependence as the slope. In the AM mode, this contrast is approximately proportional to $A^{-1/2}$, but remains much weaker than the contrast in the FM mode, which drops somewhat faster as A is increased. These trends are a consequence of the macroscopic contributions to the KPFM signal, which are stronger in the AM-mode and especially important if the sample is an insulator even at subnanometer separations where atomic-scale contrast appears.

3- Heterodyne AM-KPFM*:

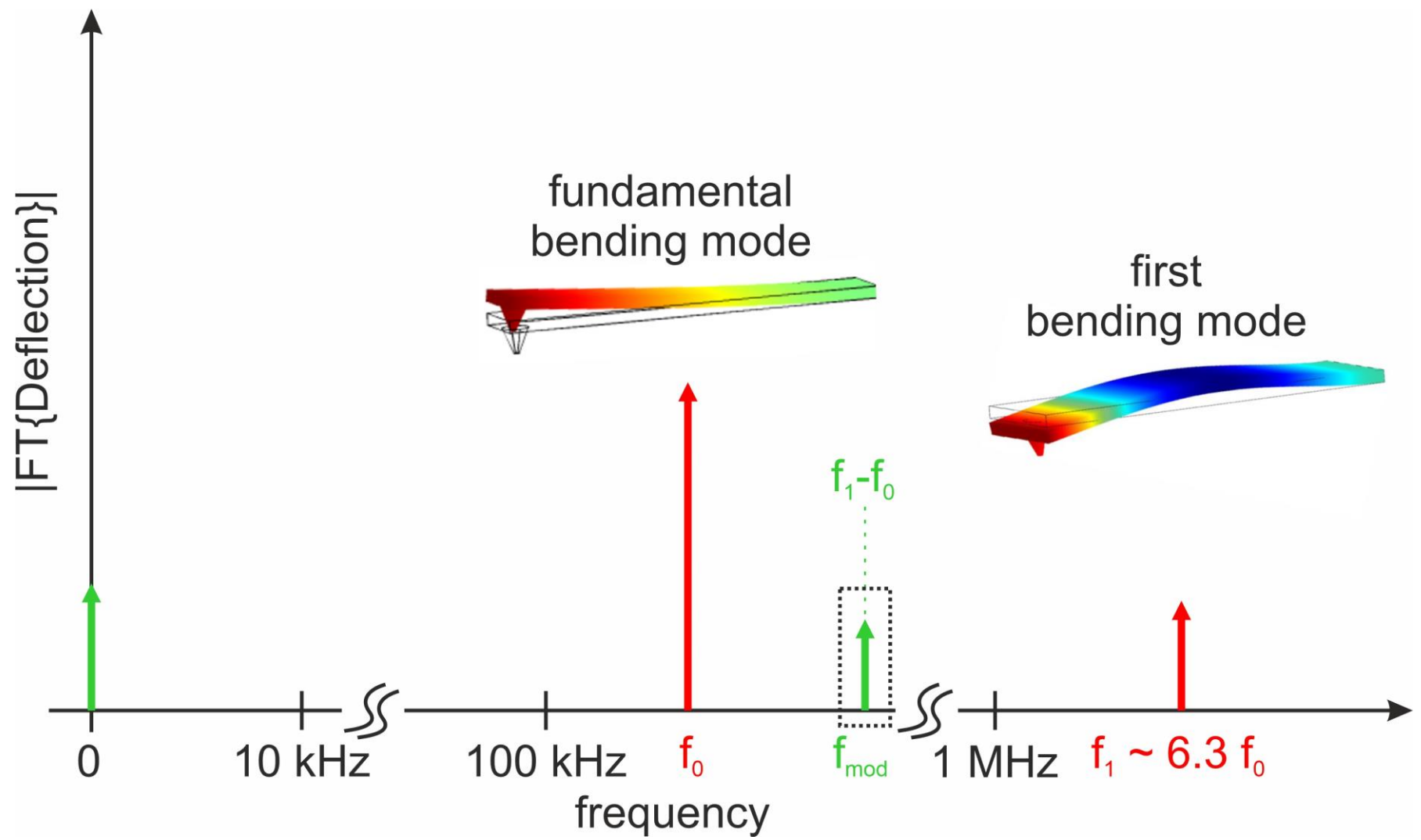

*Y.Sugarawa *et al.*, Appl. Phys. Lett. **100**, 223104 (2012)

3- Heterodyne AM-KPFM*:

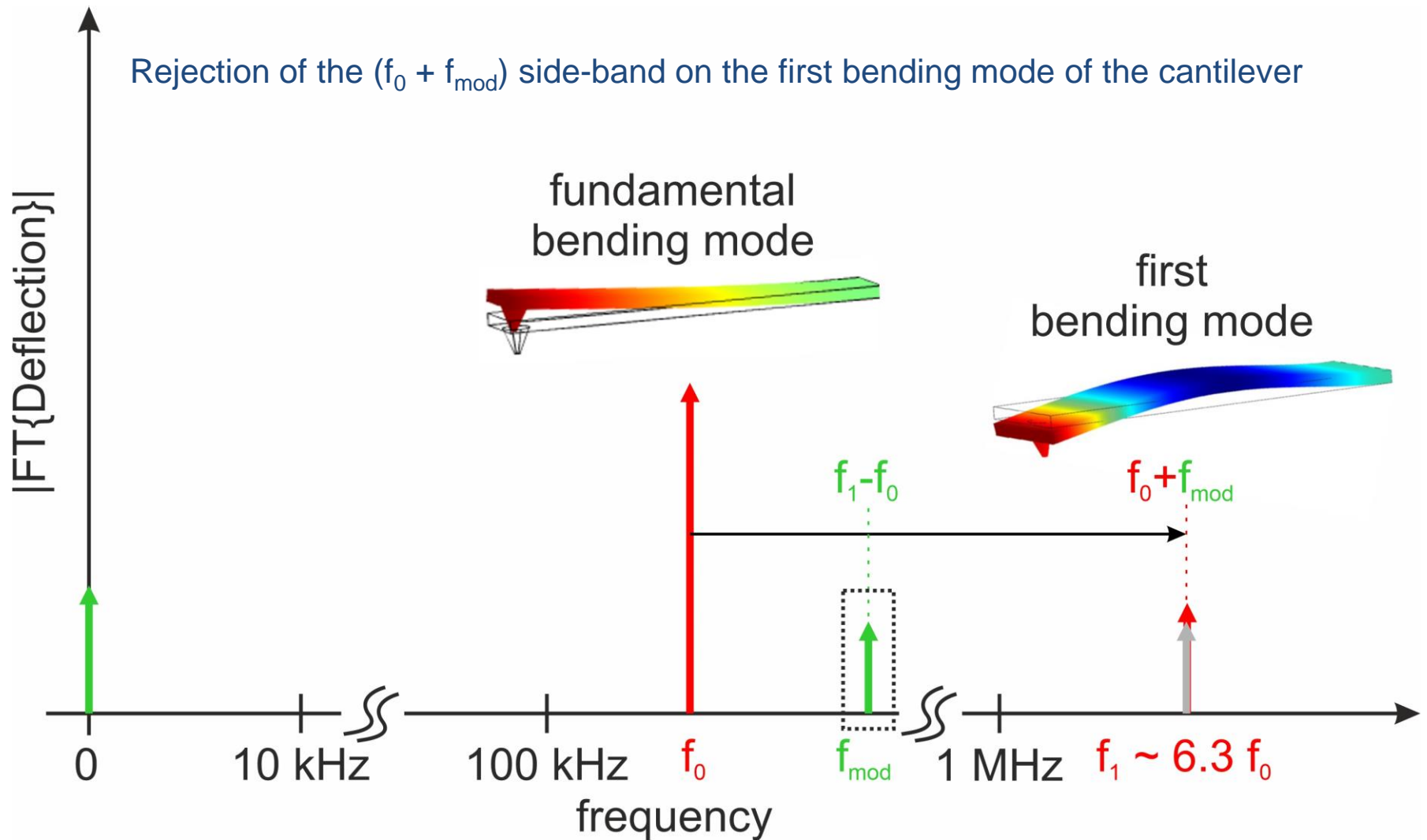

*Y.Sugarawa *et al.*, *Appl. Phys. Lett.* **100**, 223104 (2012)

3- Heterodyne AM-KPFM*:

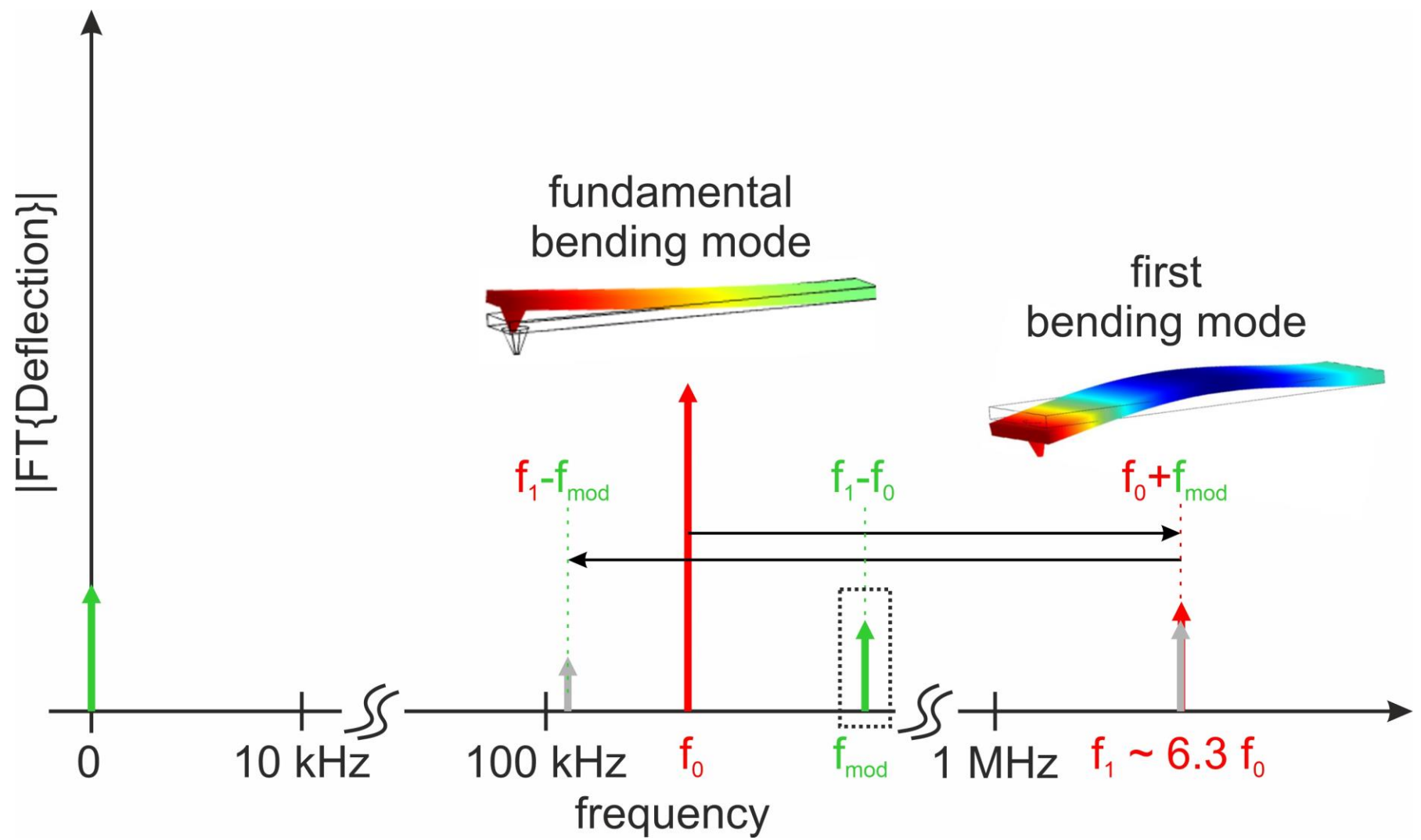

*Y.Sugarawa *et al.*, *Appl. Phys. Lett.* **100**, 223104 (2012)

3- Heterodyne AM-KPFM*:

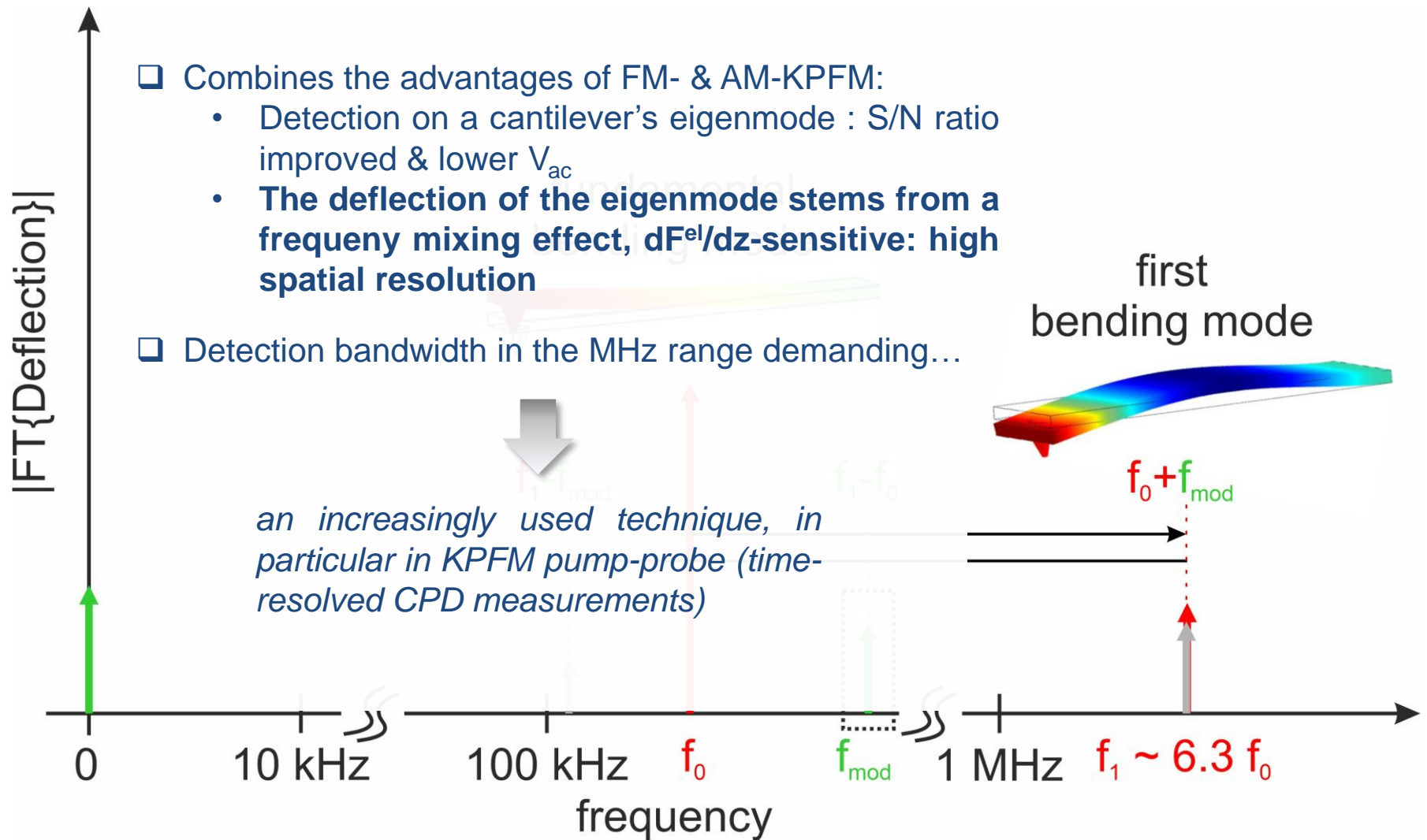

*Y.Sugarawa *et al.*, Appl. Phys. Lett. **100**, 223104 (2012)

4- Spectroscopic KPFM modes

- ❑ No further bias modulation
(no frequency mixing, easier...)
- ❑ Bias spectroscopic curves on a predefined grid
- ❑ 3D (x,y,V_b) spectroscopy...

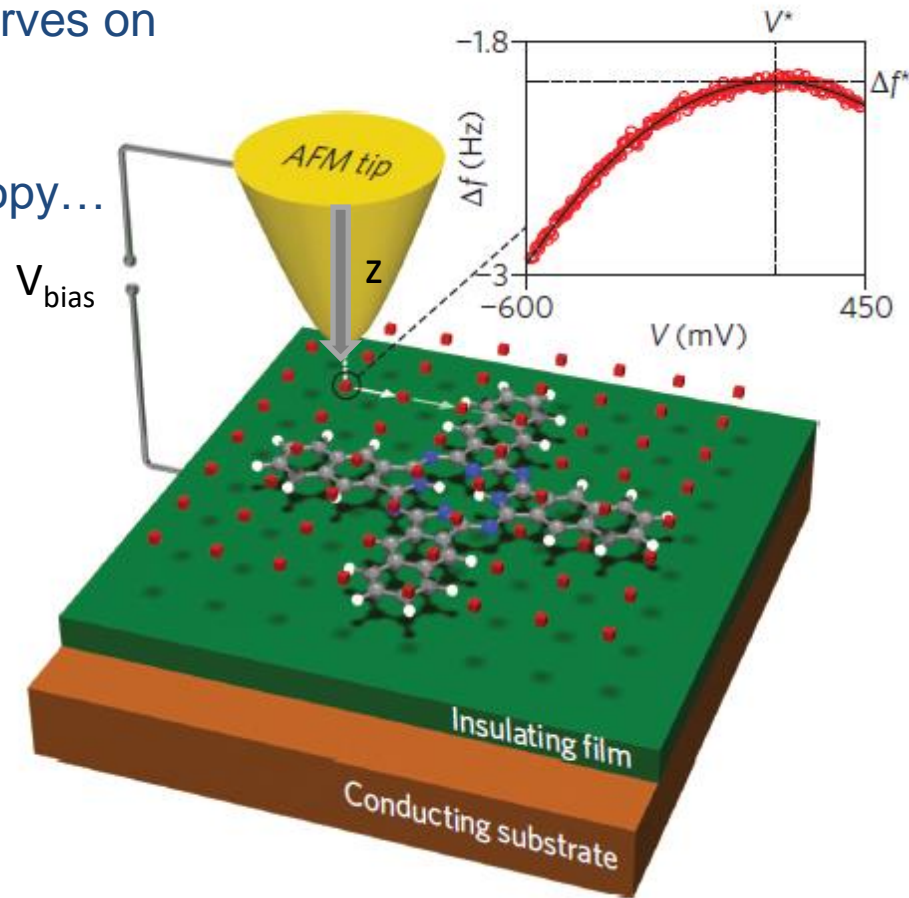

*scheme adapted from F.Mohn *et al.* Nature Nanotechnology **7**(4), 227–231 (2012)

4- Spectroscopic KPFM modes

- ❑ No further bias modulation (no frequency mixing, easier...)
- ❑ Bias spectroscopic curves on a predefined grid
- ❑ 3D (x,y,V_b) spectroscopy... and 4D (x,y,z,V_b) spectroscopy*
- ❑ **Requirements:**
 - Low temp. (weak drift & atom tracking procedure)
 - Accurate tip control (CO-functionalization)
 - Time!!! (several days over a grid)

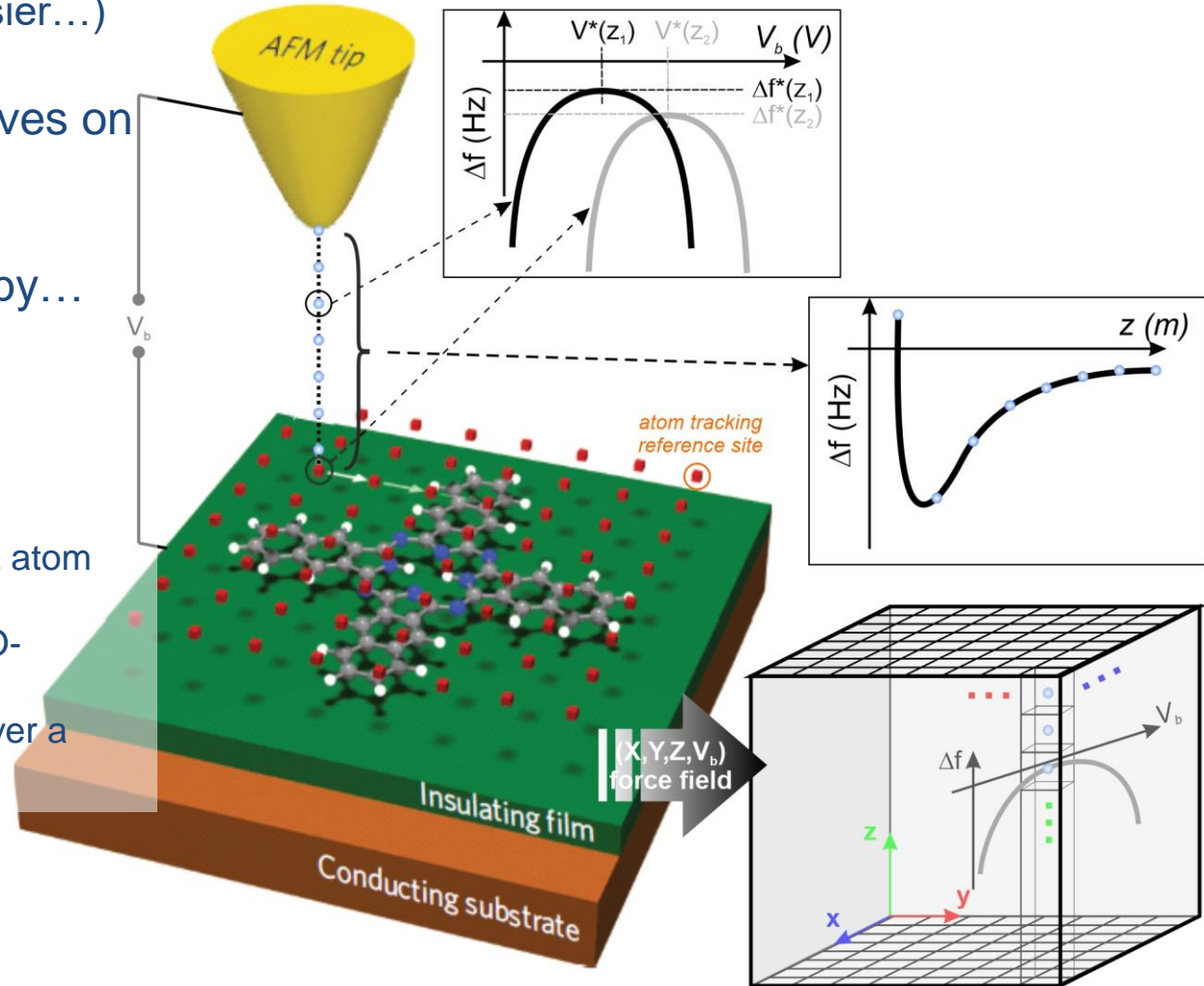

*L. Nony *et al.*, unpublished

Summary...

- ❑ In KPFM, the **bias voltage is f_{mod} -modulated**
- ❑ The frequency components of the modulated F^{el} stem from bias- and capacitance-gradient (f_0 -modulated) components that are mixed together and yield static, f_{mod} , $f_0 \pm f_{\text{mod}}$, ... deflections of the cantilever
- ❑ The magnitude of the f_{mod} & ($f_0 \pm f_{\text{mod}}$) components is proportional to $(V_{\text{dc}} - V_{\text{cpd}})$ (empty capacitor approx.)
- ❑ The KPFM technique detects the magnitude of the desired modulated component by means of a LIA that subsequently nullifies it with a PI regulator providing $V_{\text{dc}} = V_{\text{cpd}}$
- ❑ FM-KPFM is sensitive to the electrostatic force gradient $dF^{\text{el}}(z)/dz$, hence to $d^2C(z)/dz^2$, which gives the technic an important spatial resolution
- ❑ In sideband-FM-KPFM, the modulated component is $(f_0 + f_{\text{mod}})$
- ❑ In heterodyne AM-KPFM, $f_{\text{mod}} = f_1 - f_0$, which rejects the sideband on the first bending mode of the cantilever and makes the technic sensitive to $dF^{\text{el}}(z)/dz$ too, along with an advantageous S/N ratio.

Outline

I. INTRODUCTION to KPFM

II. CONCEPTS & IMPLEMENTATIONS

III. ELECTROSTATIC MODELS



IV. EXAMPLES OF APPLICATIONS



CONCLUSION

Some references...

III. Electrostatic models

Motivation

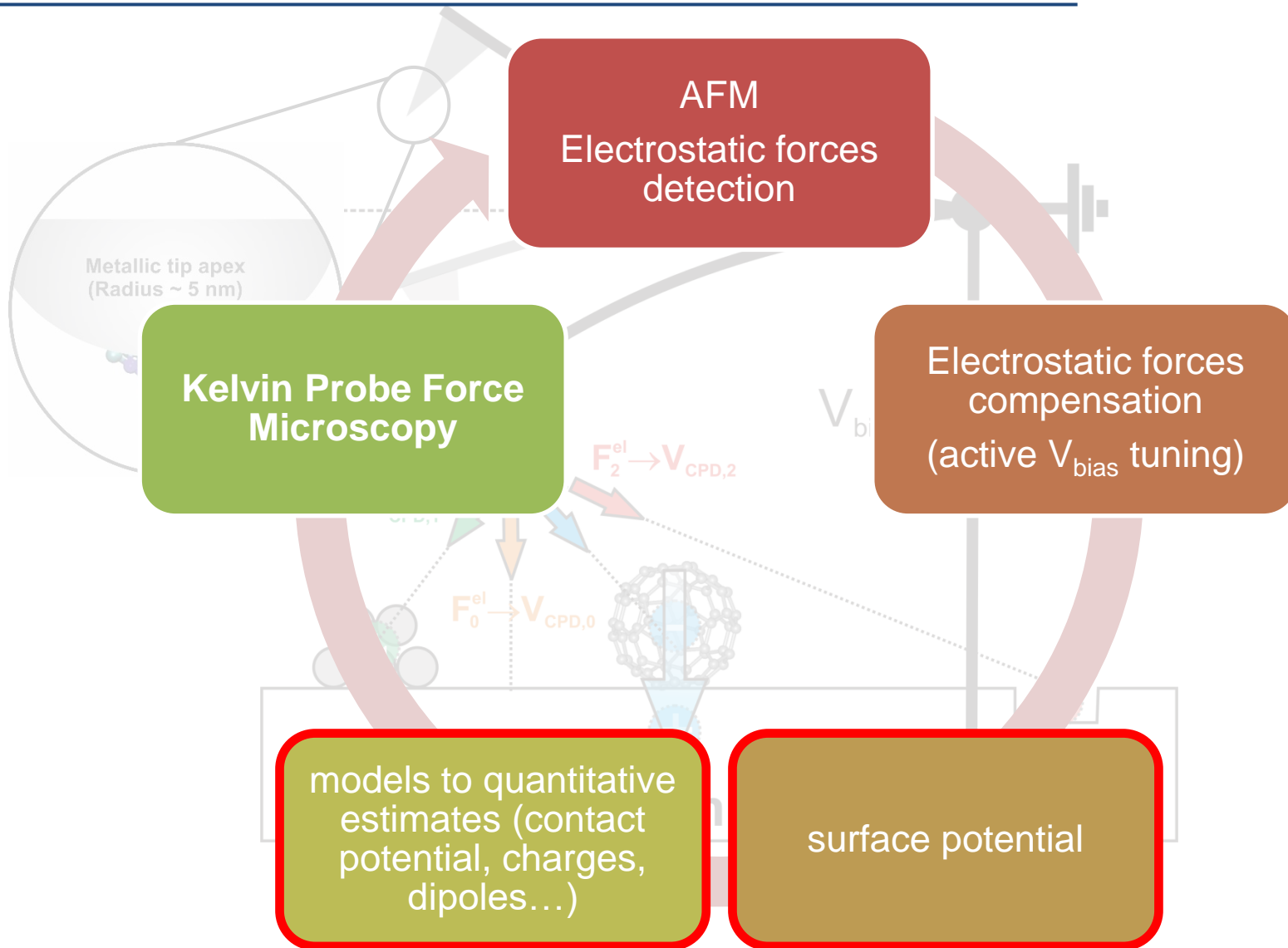

Generic approach to F^{el}

- Electrostatic energy of an ensemble of point charges inside a capacitor¹:

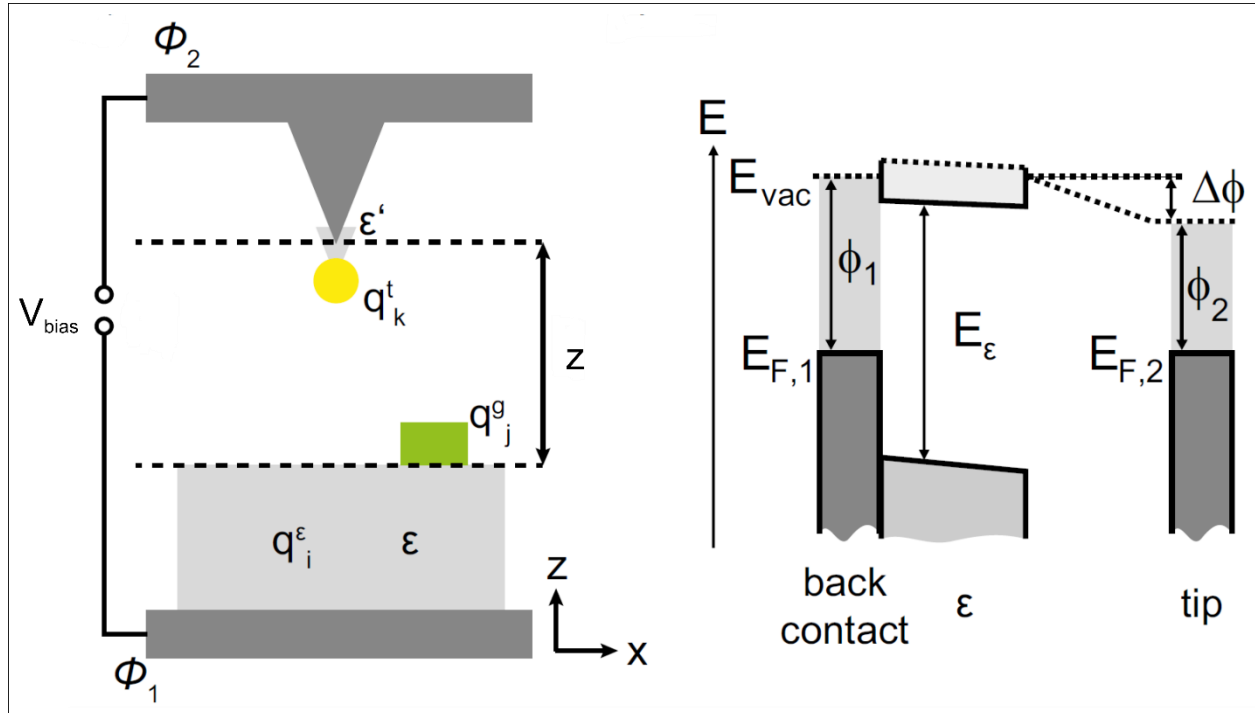

Picture adapted from [2]

$$W^{el} = -\frac{1}{2} C^{(0)} V_{\text{bias}}^2 + \sum_i q_i \phi^{(0)}(\mathbf{r}_i) + \frac{1}{2} \sum_i q_i \phi_{\text{im}}(\mathbf{r}_i) + W_{\text{Coulomb}} \quad (\text{Eq.13})$$

¹ L. Kantorovich et al., *J. Phys. Cond. Mat.* 12, 795 (2000); L. Kantorovich et al. *Surf. Sci.* 445, 283 (2000)

² J.L. Neff, P. Rahe, *Phys. Rev. B* 91, 085424 (2015)

Generic approach to F^{el}

- Electrostatic energy of an ensemble of point charges inside a capacitor¹:

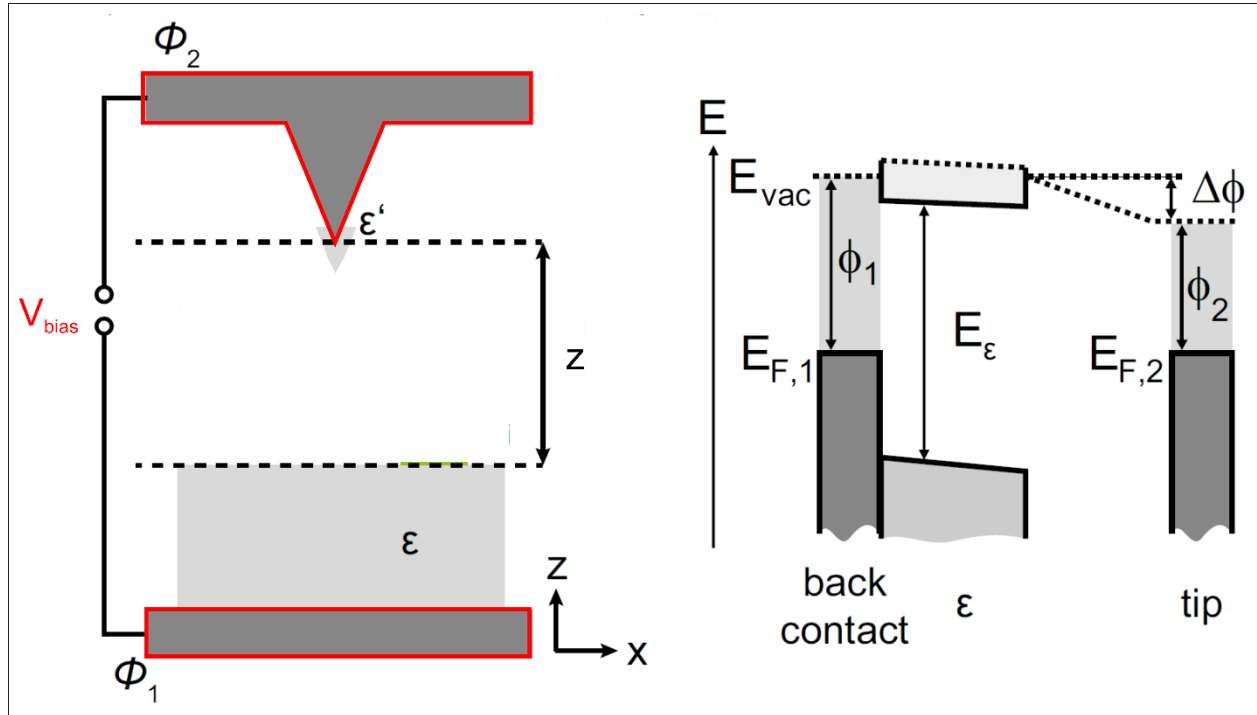

Picture adapted from [2]

$$W^{el} = -\frac{1}{2} C^{(0)} V_{bias}^2 + \sum_i q_i \phi^{(0)}(\mathbf{r}_i) + \frac{1}{2} \sum_i q_i \phi_{im}(\mathbf{r}_i) + W_{Coulomb} \quad (Eq.13)$$

¹ L. Kantorovich et al., *J. Phys. Cond. Mat.* 12, 795 (2000); L. Kantorovich et al. *Surf. Sci.* 445, 283 (2000)

² J.L. Neff, P. Rahe, *Phys. Rev. B* 91, 085424 (2015)

Generic approach to F^{el}

- Electrostatic energy of an ensemble of point charges inside a capacitor¹:

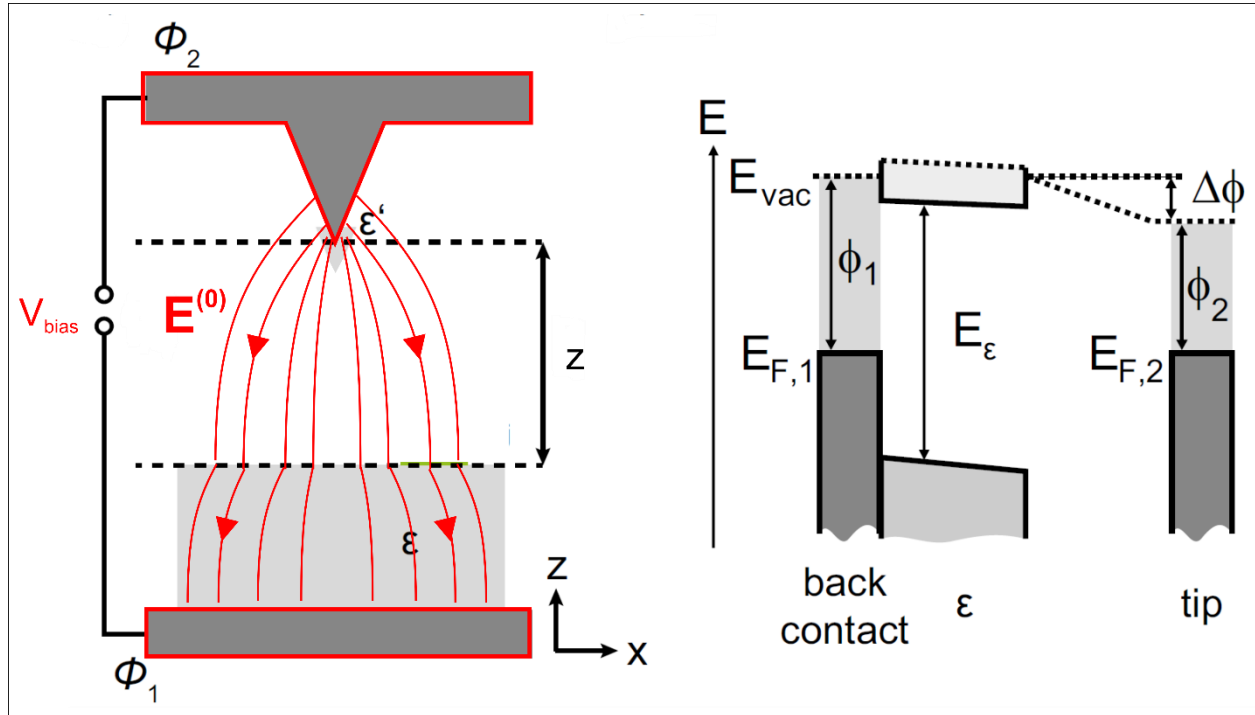

Picture adapted from [2]

$$W^{el} = -\frac{1}{2} C^{(0)} V_{bias}^2 + \sum_i q_i \phi^{(0)}(\mathbf{r}_i) + \frac{1}{2} \sum_i q_i \phi_{im}(\mathbf{r}_i) + W_{Coulomb} \quad (Eq.13)$$

¹ L. Kantorovich et al., *J. Phys. Cond. Mat.* 12, 795 (2000); L. Kantorovich et al. *Surf. Sci.* 445, 283 (2000)

² J.L. Neff, P. Rahe, *Phys. Rev. B* 91, 085424 (2015)

Generic approach to F^{el}

- Electrostatic energy of an ensemble of point charges inside a capacitor¹:

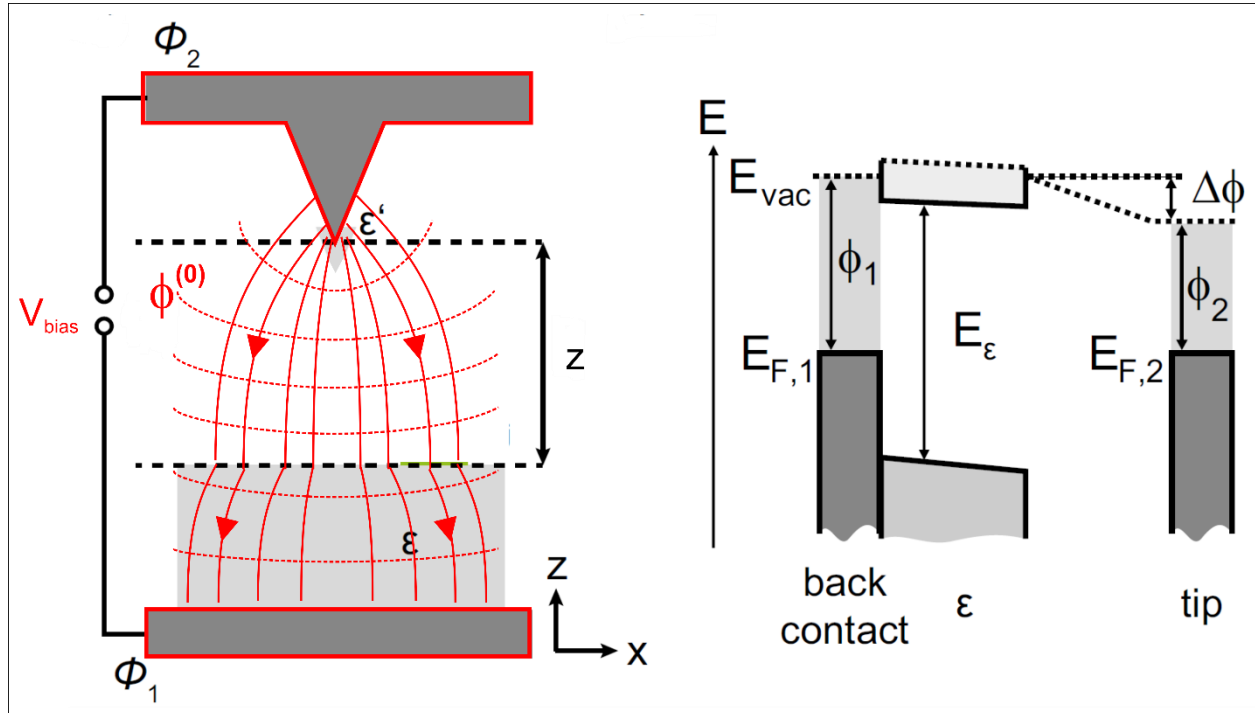

Picture adapted from [2]

$$W^{el} = -\frac{1}{2} C^{(0)} V_{\text{bias}}^2 + \sum_i q_i \phi^{(0)}(\mathbf{r}_i) + \frac{1}{2} \sum_i q_i \phi_{\text{im}}(\mathbf{r}_i) + W_{\text{Coulomb}} \quad (\text{Eq.13})$$

¹ L. Kantorovich et al., *J. Phys. Cond. Mat.* 12, 795 (2000); L. Kantorovich et al. *Surf. Sci.* 445, 283 (2000)

² J.L. Neff, P. Rahe, *Phys. Rev. B* 91, 085424 (2015)

Generic approach to F^{el}

- Electrostatic energy of an ensemble of point charges inside a capacitor¹:

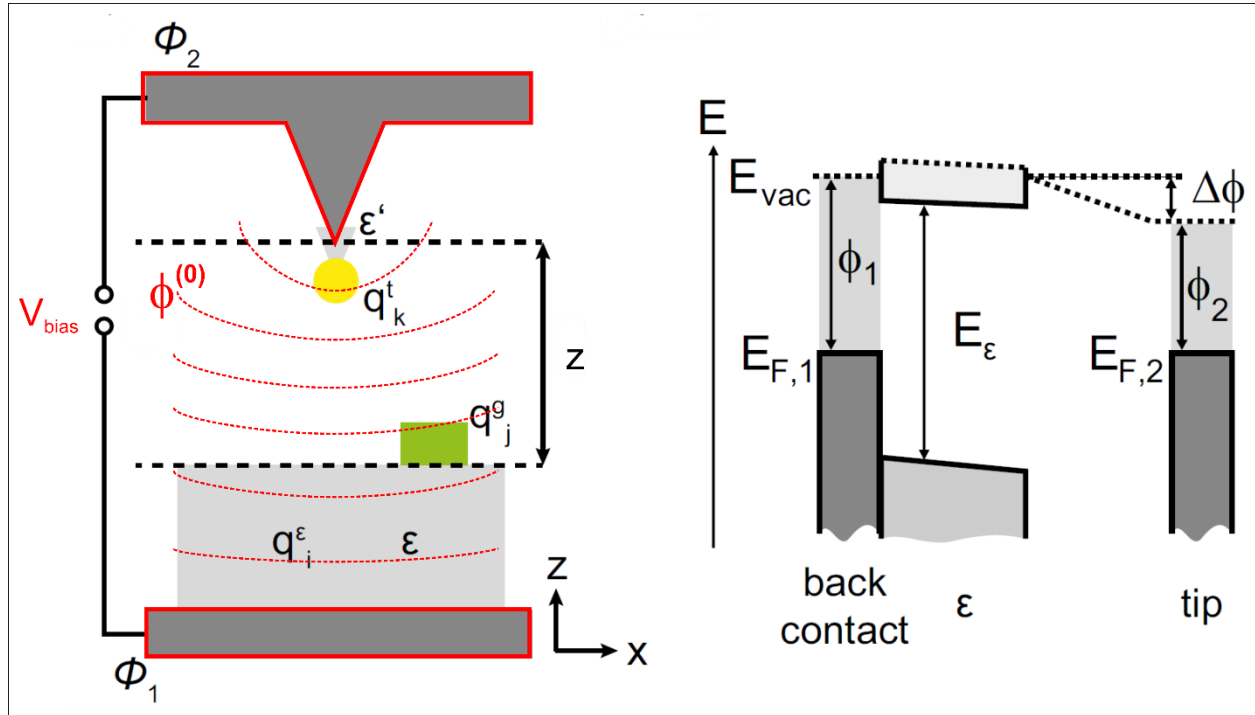

Picture adapted from [2]

$$W^{el} = -\frac{1}{2} C^{(0)} V_{bias}^2 + \sum_i q_i \phi^{(0)}(\mathbf{r}_i) + \frac{1}{2} \sum_i q_i \phi_{im}(\mathbf{r}_i) + W_{Coulomb} \quad (Eq.13)$$

¹ L. Kantorovich et al., *J. Phys. Cond. Mat.* 12, 795 (2000); L. Kantorovich et al. *Surf. Sci.* 445, 283 (2000)

² J.L. Neff, P. Rahe, *Phys. Rev. B* 91, 085424 (2015)

Generic approach to F^{el}

- Electrostatic energy of an ensemble of point charges inside a capacitor¹:

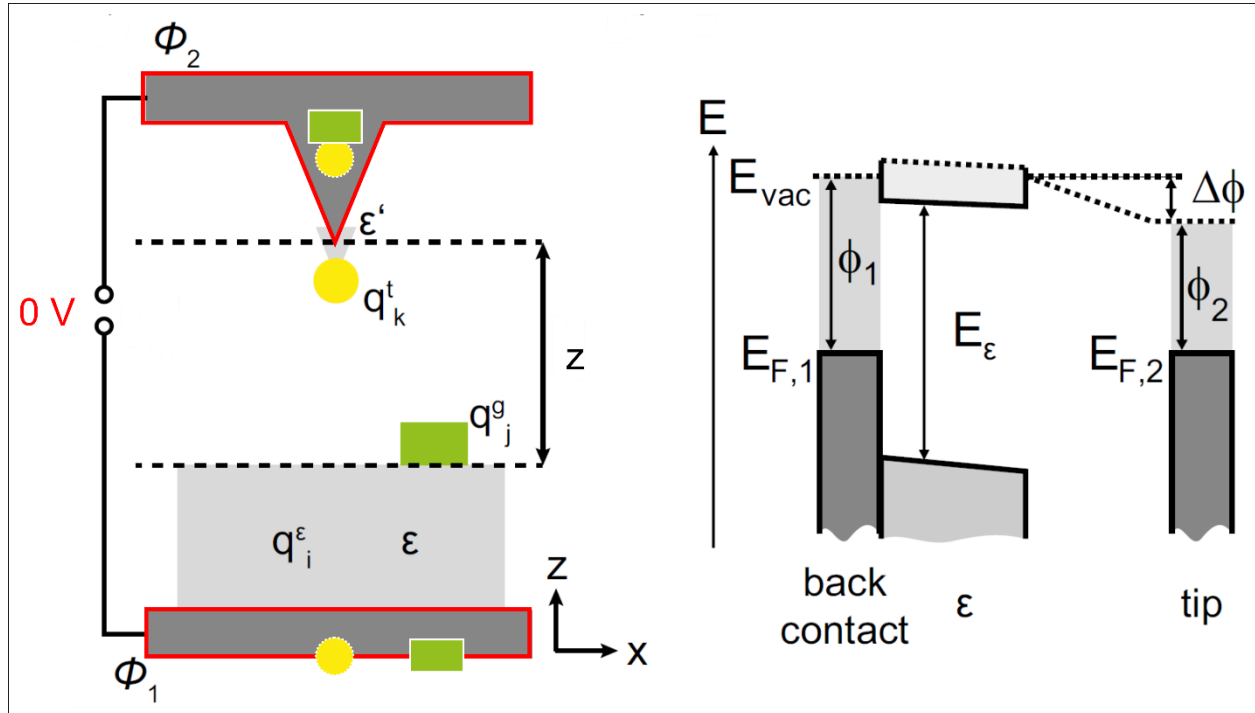

Picture adapted from [2]

$$W^{el} = -\frac{1}{2} C^{(0)} V_{\text{bias}}^2 + \sum_i q_i \phi^{(0)}(\mathbf{r}_i) + \frac{1}{2} \sum_i q_i \phi_{\text{im}}(\mathbf{r}_i) + W_{\text{Coulomb}} \quad (\text{Eq.13})$$

¹ L. Kantorovich et al., *J. Phys. Cond. Mat.* 12, 795 (2000); L. Kantorovich et al. *Surf. Sci.* 445, 283 (2000)

² J.L. Neff, P. Rahe, *Phys. Rev. B* 91, 085424 (2015)

Generic approach to F^{el}

- Electrostatic energy of an ensemble of point charges inside a capacitor¹:

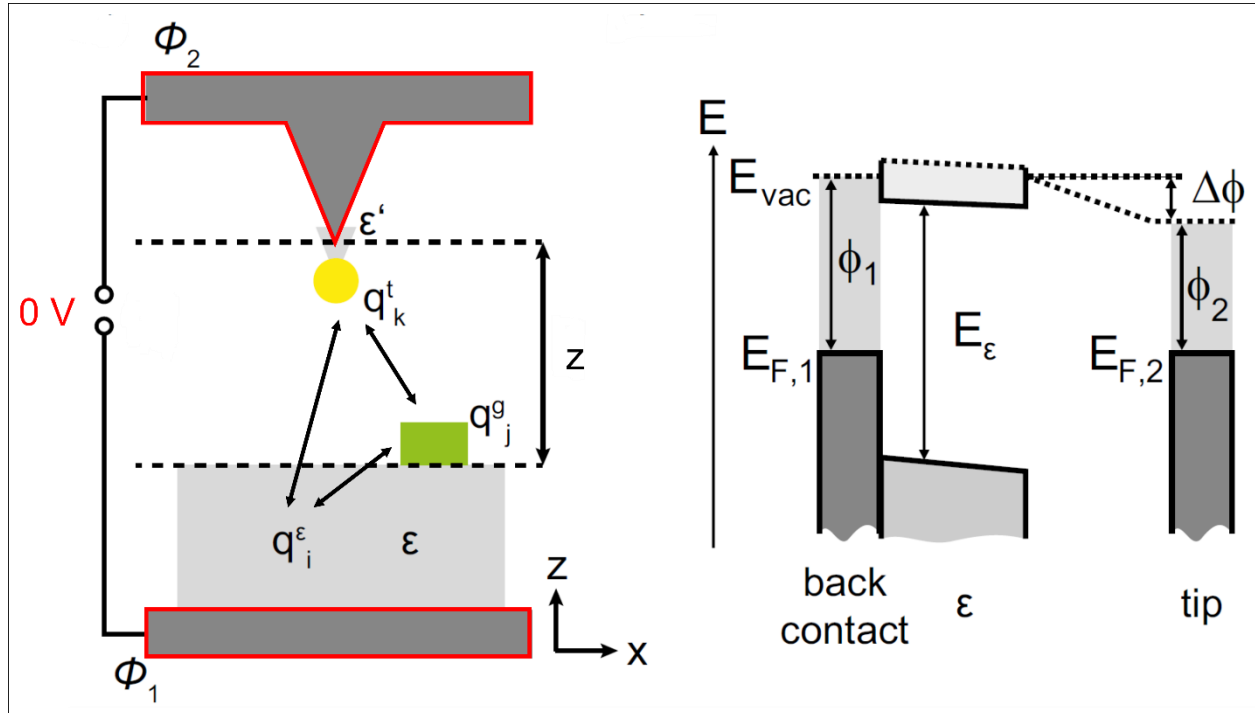

Picture adapted from [2]

$$W^{el} = -\frac{1}{2} C^{(0)} V_{\text{bias}}^2 + \sum_i q_i \phi^{(0)}(\mathbf{r}_i) + \frac{1}{2} \sum_i q_i \phi_{\text{im}}(\mathbf{r}_i) + W_{\text{Coulomb}} \quad (\text{Eq.13})$$

¹ L. Kantorovich et al., *J. Phys. Cond. Mat.* 12, 795 (2000); L. Kantorovich et al. *Surf. Sci.* 445, 283 (2000)

² J.L. Neff, P. Rahe, *Phys. Rev. B* 91, 085424 (2015)

Generic approach to F^{el}

$$\vec{F}_{tot} = \vec{F}_{LR} + \vec{F}_{SR} = \left[\vec{F}_{LR}^{el} + \vec{F}_{LR}^{vdW} \right] + \left[\vec{F}_{SR}^{el} + \vec{F}_{SR}^{vdW} \right]$$

- W^{el} requires to know the potential generated by the void capacitor upon biasing: **mesoscopic range (mm-nm)**

- ✓ Usually: finite elements methods + Poisson equation or Green's formalism + boundary conditions

- Charges and dipoles yield *short-range electrostatic forces: microscopic range (nm-pm)*

- ✓ Ab initio computational methods, or analytic methods

PHYSICAL REVIEW B **86**, 075407 (2012)

Multiscale approach for simulations of Kelvin probe force microscopy with atomic resolution

Ali Sadeghi, Alexis Baratoff, S. Alireza Ghasemi, Stefan Goedecker, Thilo Glatzel, Shigeki Kawai, and Ernst Meyer
Department of Physics, University of Basel, Klingelbergstrasse 82, CH-4056 Basel, Switzerland

PHYSICAL REVIEW B **91**, 085424 (2015)

Insights into Kelvin probe force microscopy data of insulator-supported molecules

Julia L. Neff

Institut für Physikalische Chemie, Johannes Gutenberg Universität Mainz, Duesbergweg 10-14, 55099 Mainz, Germany

Philipp Rahe*

Department of Physics and Astronomy, The University of Utah, 115 South 1400 East, Salt Lake City, Utah 84112-0830, USA
 (Received 1 September 2014; revised manuscript received 28 January 2015; published 24 February 2015)

Examples: 1- double capacitance model (mesoscopic model)

- A charge inside the capacitor¹:

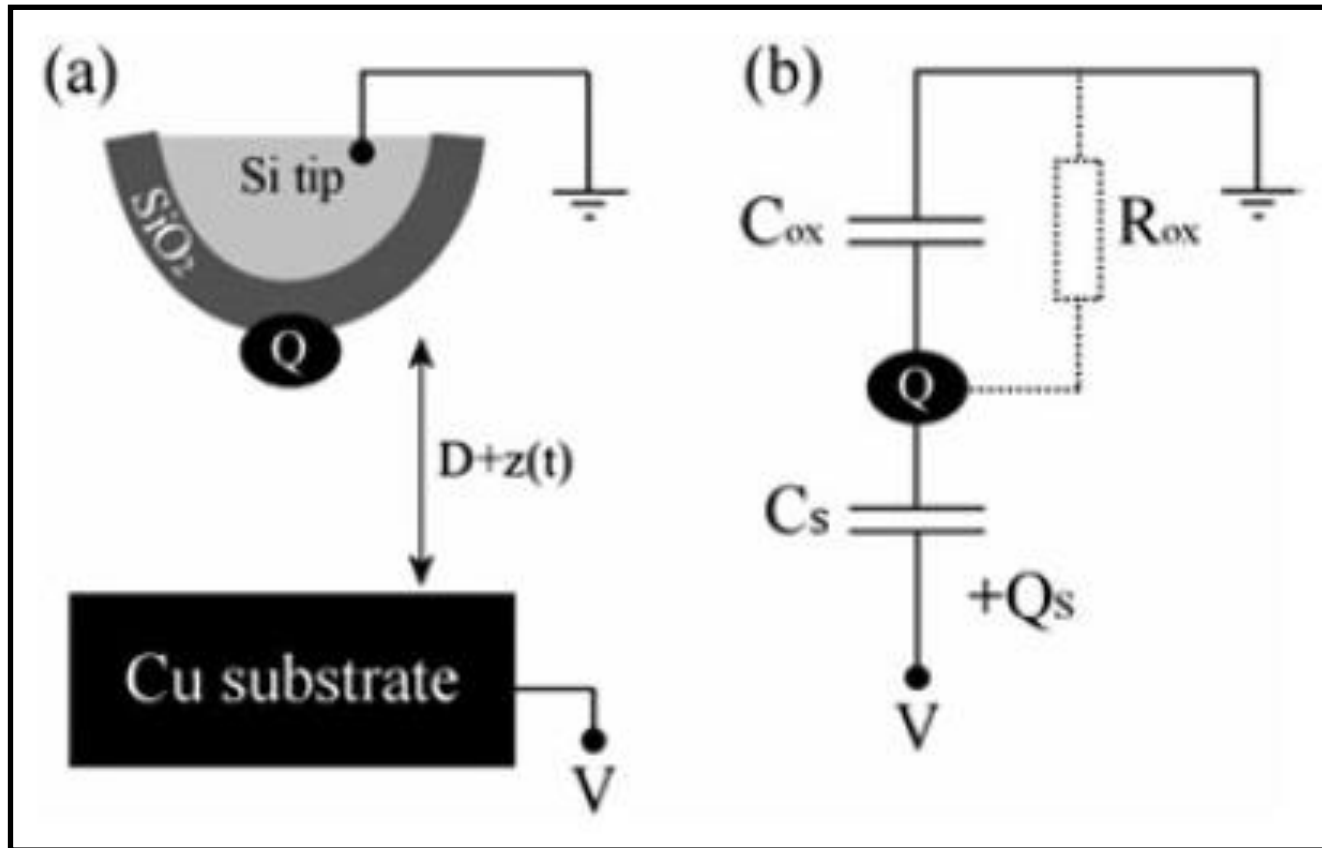

J. Polesel et al., Nanotechnology 15, S24 (2004)

Examples: 1- double capacitance model (mesoscopic model)

□ A charge inside the capacitor¹:

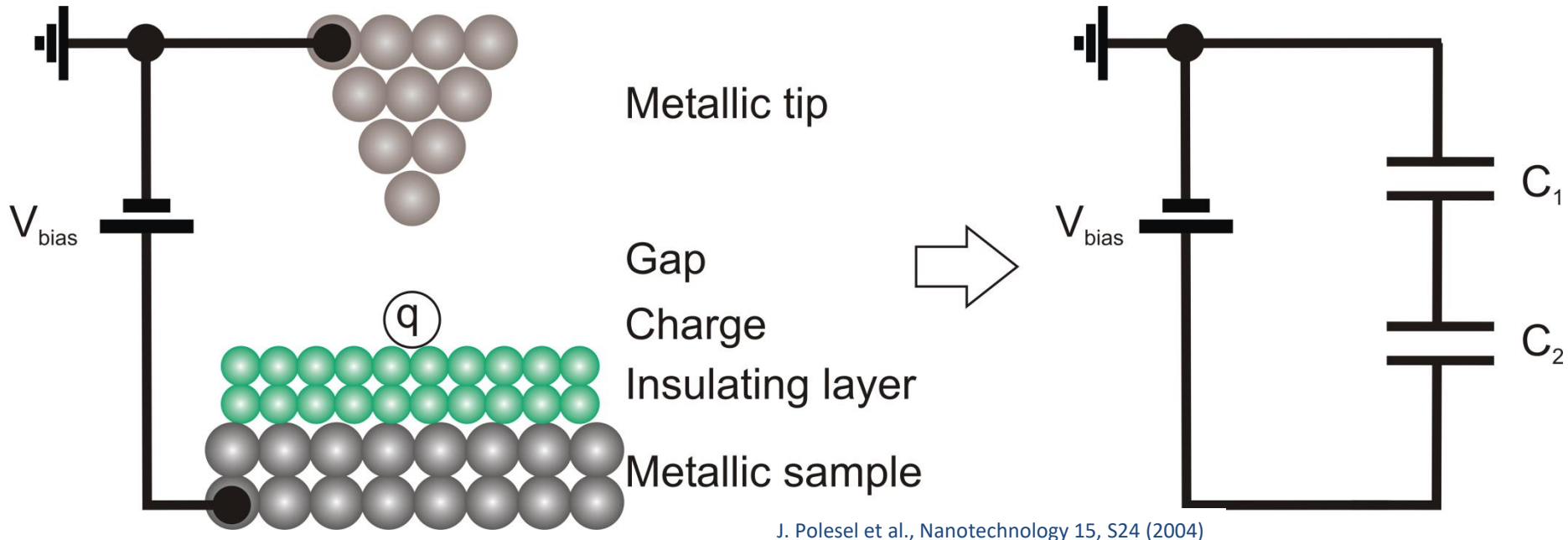

$$F^{\text{el}} = \frac{1}{C_{\Sigma}^2} \frac{\partial C_1}{\partial z} \left(\frac{q^2}{2} + \frac{1}{2} C_2^2 V_{\text{bias}}^2 - C_2 q V_{\text{bias}} \right) \quad (\text{Eq. 14})$$

¹Nanoelectronics and Information Technology: Advanced Electronic Materials and Novel Devices, edited by R. Waser (John Wiley & Sons, New York, 2003); R. Stomp et al., Pys. Rev. Lett. 94 , 056802 (2005); J. Polesel et al., Nanotechnology 15, S24 (2004)

Examples: 2- microscopic approach to F^{el} : polarizability

1

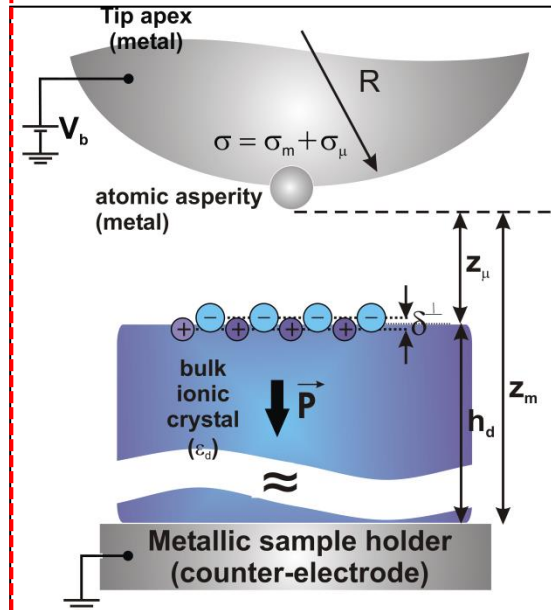

- **Tip termination:** metallic atomic asperity
- **Sample:** Bulk ionic crystal
- **Analytical & Experimental approach**

F.Bocquet et al., Phys. Rev. B **78**, 035410 (2008)
L.Nony et al., Nanotechnology **20**, 264014 (2009)

2

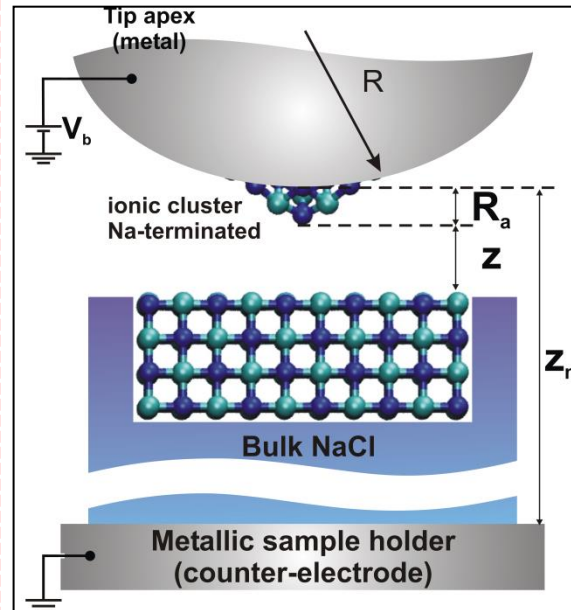

- **Tip termination:** ionic cluster (Na⁺-terminated)
- **Sample:** Bulk ionic crystal
- **Fully numerical approach**

L.Nony et al., Phys. Rev. Lett. **103**, 036802 (2009)

3

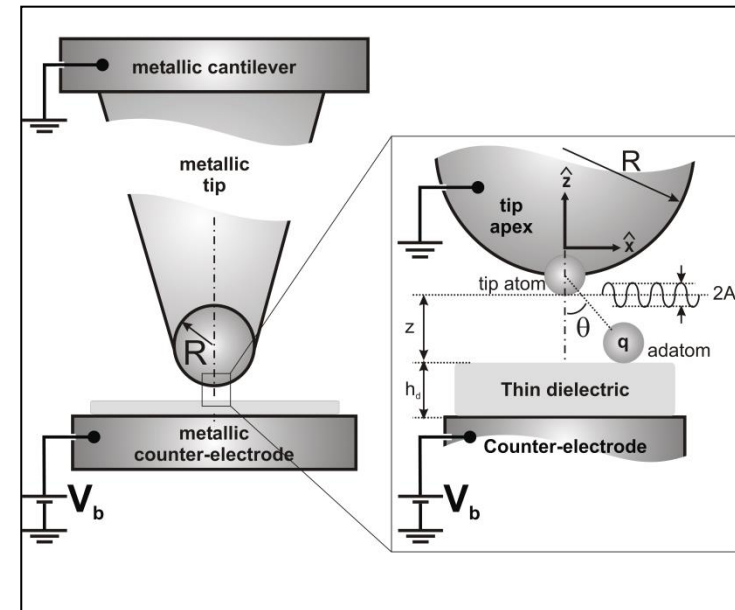

- **Tip termination:** single metallic atom
- **Sample:** 2ML NaCl / Cu(111)
- **Fully analytical approach**

F.Bocquet et al., Phys.Rev.B **83**, 035411 (2011)
Based upon the work by L.Gross et al. Science **324**, 1428 (2009)

Examples: 2- microscopic approach to \mathbf{F}^{el} : polarizability

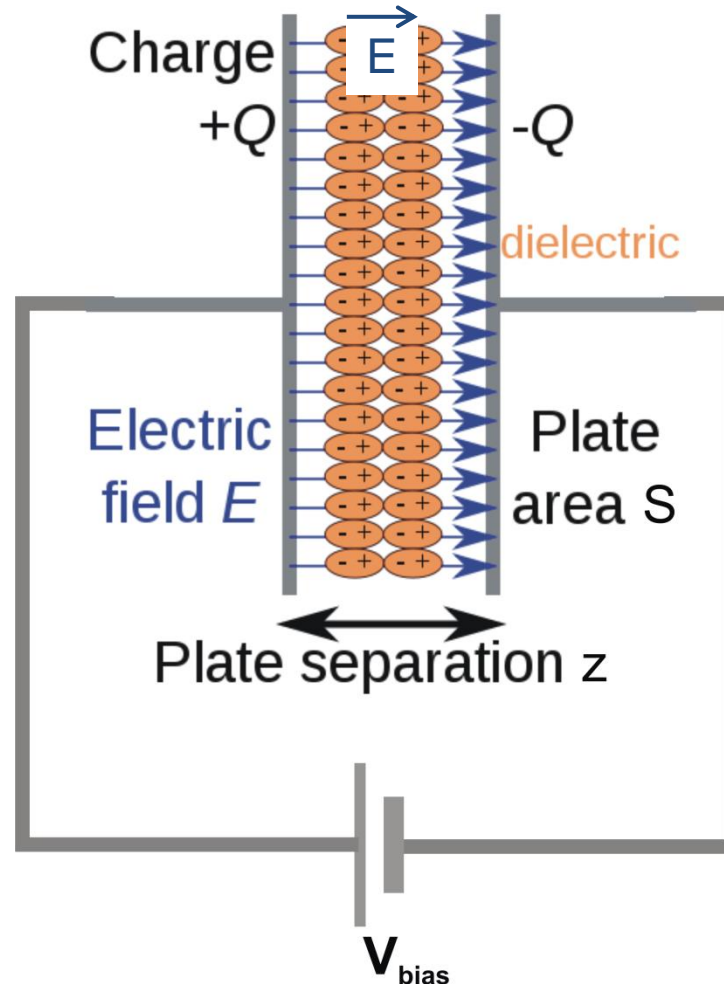

Dipole moment of each part of dielectric within the capacitance:

polarizability

$$\vec{p} = \alpha \epsilon_0 \vec{E}$$

Examples: 2- microscopic approach to F^{el} : polarizability

Interaction force : $F(z) = F_{lr}(z) + F_{es}(z) + F_{sr}(z)$ with $F_{es} = \int_{\text{tip}} \frac{\sigma^2}{2\epsilon_0} \hat{n} \cdot \hat{u}_z dS$

Building the analytic approach to F_{es} :

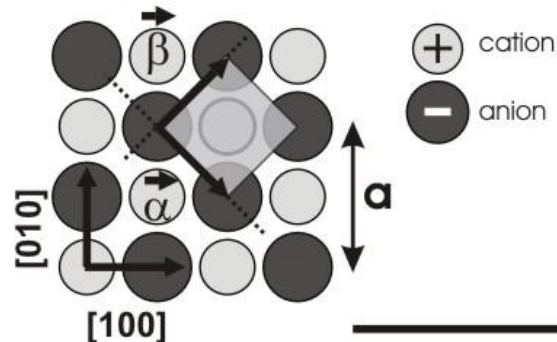

- Crystal surface has a perfect fcc structure, carrying **neither local charge nor dipole**
- The **Madelung potential expands at the surface²**, although decaying exponentially fast

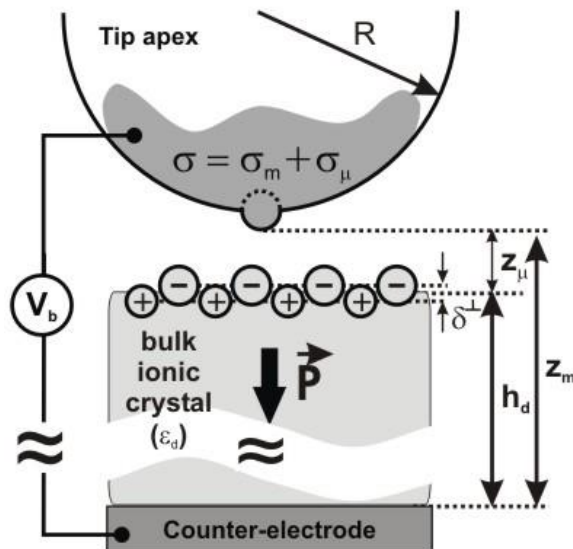

- Tip apex:** microscopic structure (nano-asperity, area 1, radius R_a) + mesoscopic half-sphere (area 2, radius R): **METALLIC**
- Sample:** topmost infinite layer of alternate point charges + bulk treated as a continuous medium
- Surface charge density that develops on the tip has 2 origins:
 - ☞ **capacitive contribution (mesoscopic):** σ_m , connected with V_b
 - ☞ **Madelung surface potential-mediated contribution (microsc.):** σ_μ
- Description of the ionic polarization of the sample , self-consistency**
- Classical approach

¹ F. Bocquet *et al.*, Phys. Rev. B **78**, 035410 (2008); ² R. Watson *et al.*, Phys. Rev. B **24**, 1791 (1981)

Examples: 2- microscopic approach to F^{el} : polarizability

Superposition principle :

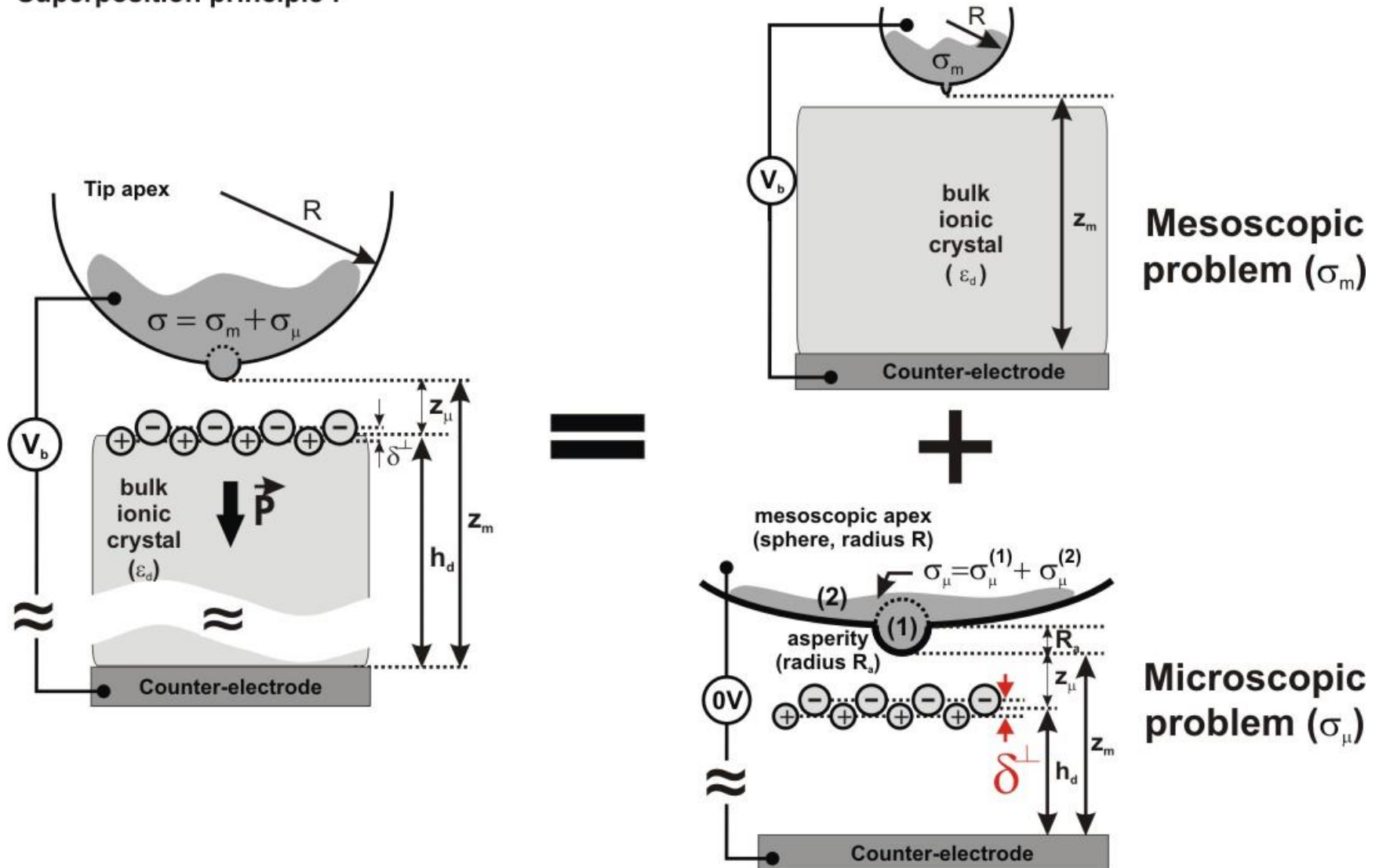

Examples: 2- microscopic approach to F^{el} : polarizability

Madelung surface potential¹:

$$V_s(x, y, z, \mu) = - \frac{q}{\pi \epsilon_0 a'} \cosh[\tilde{\delta}^\perp(V_b)] \tilde{\chi}(x, y) e^{-(2\pi/a')z, \mu}$$

Polarization, i.e. Bias dependence

Lateral periodicity (in plane)

$$\tilde{\chi}(x, y) = \cos\left[\frac{2\pi}{a'}(x - x_0)\right] + \cos\left[\frac{2\pi}{a'}(y - y_0)\right]$$

Distance dependence

"...when considering an infinite planar slab of point charges, the Madelung surface potential reaches its asymptotic value in a very short distance normal to the slab. Consequently, the ions within the crystal at a distance only one lattice constant from the surface have Madelung potentials, which are indistinguishable from those of the bulk."

¹ R.Watson et al., Phys. Rev. B **24**, 1791 (1981)

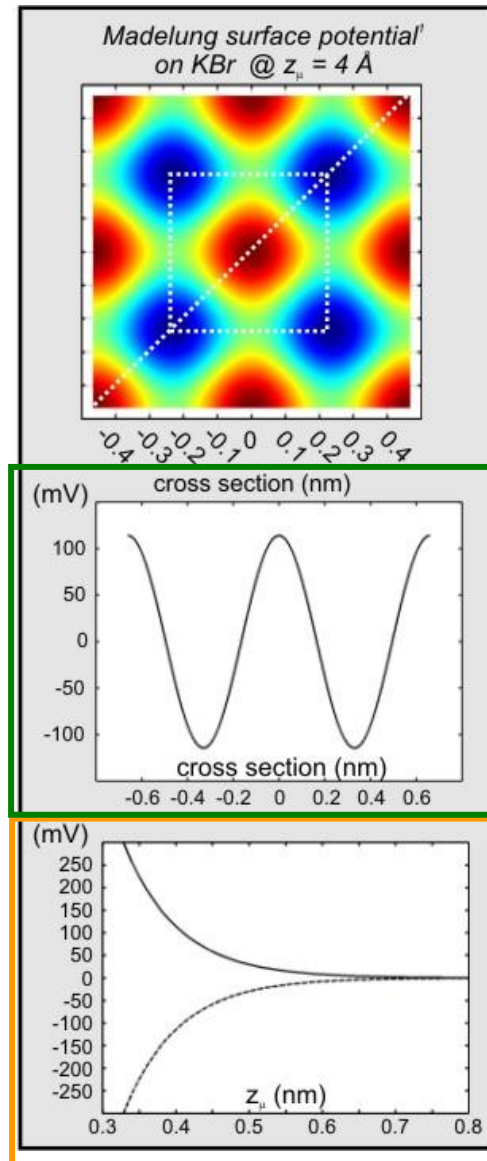

Examples: 2- microscopic approach to F^{el} : polarizability

$$F_{es} = \int_{\text{tip}} \frac{(\sigma_m + \sigma_\mu)^2}{2\epsilon_0} \hat{n} \cdot \hat{u}_z dS = F_m + F_{m\mu} + F_\mu$$

- F_m : negligible (counter-electrode too far)
- $F_{m\mu}^{(2)}$: capacitive coupling on the mesoscopic part of the tip decays fast; negligible compared to $F_{m\mu}^{(1)}$; tip enhancement effect
- $F_\mu^{(1)}$: negligible compared to $F_\mu^{(2)}$ (not obvious, geometry dependent)

$$F_{es} = F_{m\mu}^{(1)} + F_\mu^{(2)}$$

- short-range
- Lateral periodicity of the MSP
- Proportional to V_b

- short-range
- V_b^2 dependence (required!!!) induced by the **polarization**
- No lateral periodicity

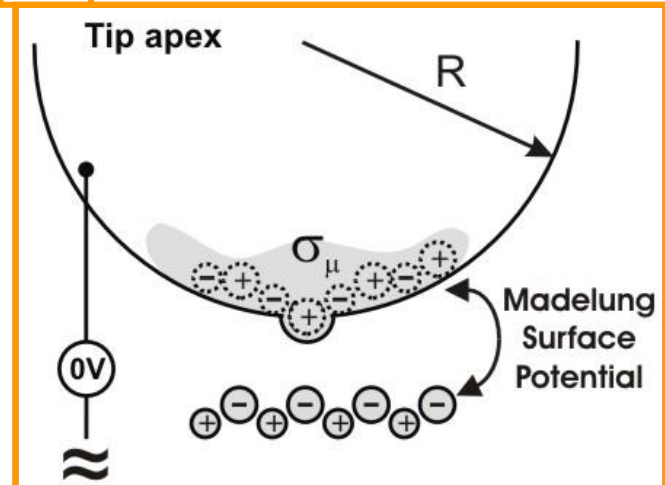

$$F_{es}(V_b) = B \times V_b \exp \left\{ -\frac{2\pi}{a'} z_\mu \right\} \times [\cos(\tilde{x}_0) + \cos(\tilde{y}_0)] + (AV_b^2 + C) \times \exp \left\{ -\frac{4\pi}{a'} z_\mu \right\}$$

with $V_b = V_{dc} + V_{ac} \sin(2\pi f_K t)$

short-range electrostatic force

Examples: 2- microscopic approach to F^{el} : polarizability

$$F_{es} = \int_{\text{tip}} \frac{(\sigma_m + \sigma_\mu)^2}{2\epsilon_0} \hat{n} \cdot \hat{u}_z dS = F_m + F_{m\mu} + F_\mu$$

- ☞ F_m : negligible (counter-electrode too far)
- ☞ $F_{m\mu}^{(2)}$: capacitive coupling on the mesoscopic part of the tip decays fast; negligible compared to $F_{m\mu}^{(1)}$; tip enhancement effect
- ☞ $F_\mu^{(1)}$: negligible compared to $F_\mu^{(2)}$ (not obvious, geometry dependent)

$$F_{es} = F_{m\mu}^{(1)} + F_\mu^{(2)}$$

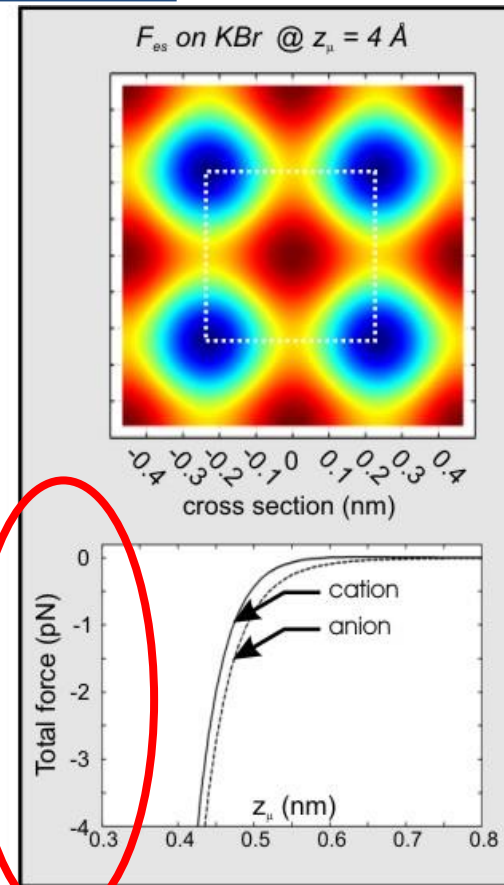

$$F_{es}(V_b) = B \times V_b \exp \left\{ -\frac{2\pi}{a'} z_\mu \right\} \times [\cos(\tilde{x}_0) + \cos(\tilde{y}_0)] + (AV_b^2 + C) \times \exp \left\{ -\frac{4\pi}{a'} z_\mu \right\}$$

with $V_b = V_{dc} + V_{ac} \sin(2\pi f_K t)$

short-range electrostatic force (Eq.15)

Summary...

- ❑ The quantitative interpretation of the KPFM signal requires sophisticated multiscale approaches: mesoscopic range (CPD), microscopic range (charges, dipoles, polarization effects...) → **LR- & SR-electrostatic forces**

- ❑ F^{el} is then a function of the bias with the form :

$$F^{\text{el}} = AV_{\text{bias}}^2 + BV_{\text{bias}} + C$$

- ❑ The f_{mod} -modulated component now has the form :

$$F^{\text{el}, f_{\text{mod}}} = [B + 2A(V_{\text{dc}} - V_{\text{CPD}})] V_{\text{ac}} \sin(2\pi f_{\text{mod}} t)$$

- ❑ Therefore:

$$V_{\text{dc}} = V_{\text{CPD}} - \frac{B}{2A}$$

- ✓ The measured « CPD » conceals the physics of the interface (parameters A & B): charges, dipoles, polarization effects
- ✓ (A & B) → (A(z) & B(z)): **tip geometry- and distance-dependent**
- ✓ Extracting quantitative parameters (number of charges...) requires the empty capacitor to be perfectly characterized

Summary...

- The quantitative interpretation of the KPFM signal requires sophisticated multiscale approaches: mesoscopic range (CPD), microscopic range (charges, dipoles, polarization effects...) → **LR- & SR electrostatic forces**

- F^{el} is then a function of the bias with the form:

$$F^{\text{el}} = AV_{\text{bias}}^2 + BV_{\text{bias}} + C$$

- The f_{mod} -modulated component now has the form:

$$F^{\text{el}, f_{\text{mod}}} = [B + 2A(V_{\text{dc}} - V_{\text{CPD}})] V_{\text{ac}} \sin(2\pi f_{\text{mod}} t)$$

- Therefore:

$$V_{\text{dc}} = V_{\text{CPD}} - \frac{B}{2A}$$

$$V_{\text{DC}}^{(c)} = V_{\text{cpd}} - \frac{C_1 a_1 e^{-\alpha z_{\text{min}}}}{2C_2 b_1 e^{-2\alpha z_{\text{min}}} + 4\pi C_2' A_0 / z_M^3}$$

L.Nony *et al.*, Nanotechnology **20**, 264014 (2009)

$\Delta V_{\text{FM-KPFM}}$

$$= \frac{\Delta\phi}{e} + \frac{\sum_i q_i \int_{-A_0}^{A_0} \frac{\partial \tilde{\Phi}^{(0)}(\vec{r}_i)}{\partial d} \Big|_{d+A_0-\tau} \frac{\tau}{\sqrt{A_0^2-\tau^2}} d\tau}{\int_{-A_0}^{A_0} \frac{\partial C^{(0)}}{\partial d} \Big|_{d+A_0-\tau} \frac{\tau}{\sqrt{A_0^2-\tau^2}} d\tau}$$

J.Neff *et al.*, PRB **91**, 085434 (2015)

Summary...

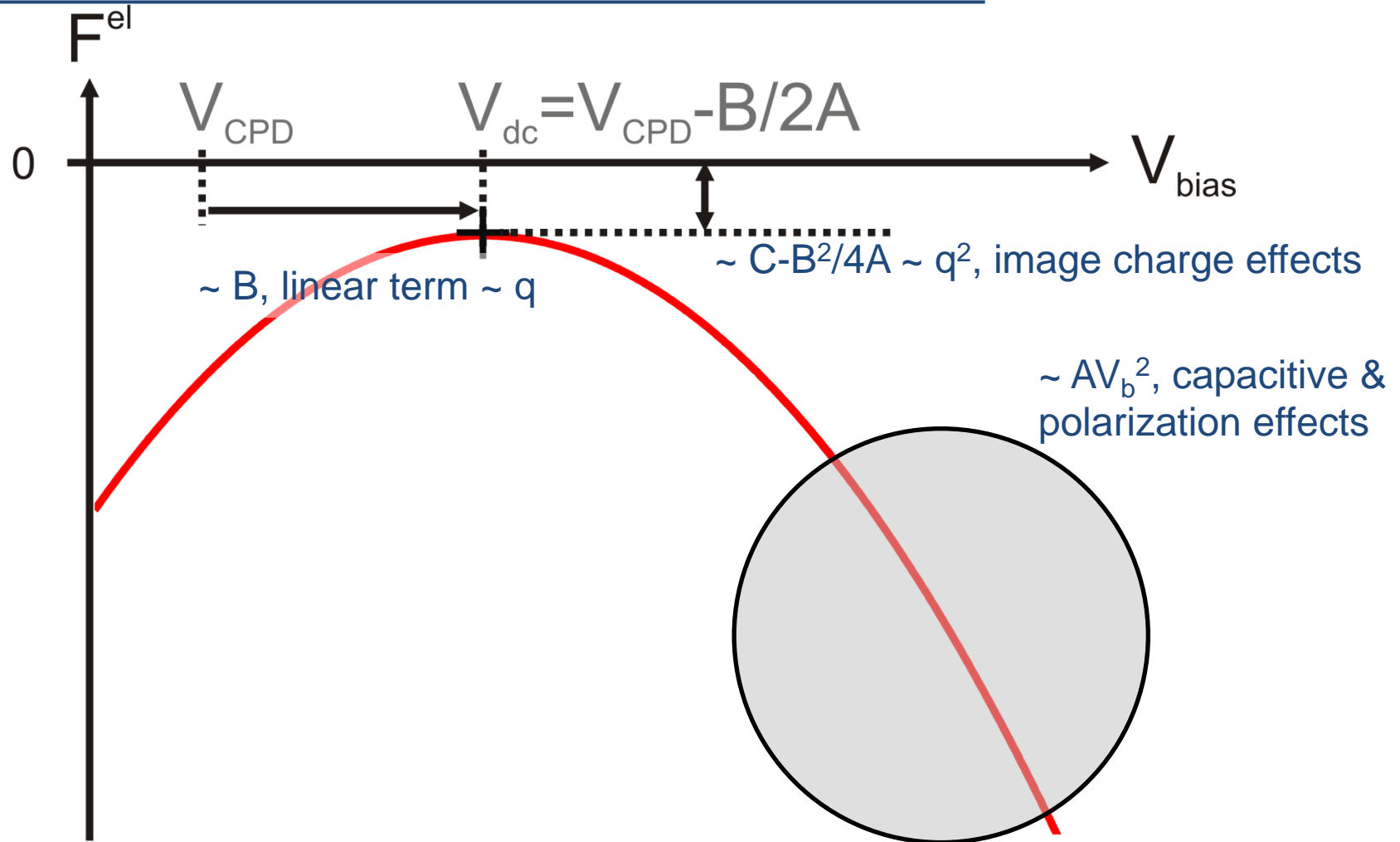

Outline

I. INTRODUCTION to KPFM

II. CONCEPTS & IMPLEMENTATIONS

III. ELECTROSTATIC MODELS



IV. EXAMPLES OF APPLICATIONS



CONCLUSION

Some references...

IV. Examples of applications

- Long-range regime

- Short-range regime

KPFM on metallic surfaces including adsorbates:

□ Thin insulating inorganic films :

KCl on Au(111)¹ (FM-KPFM):

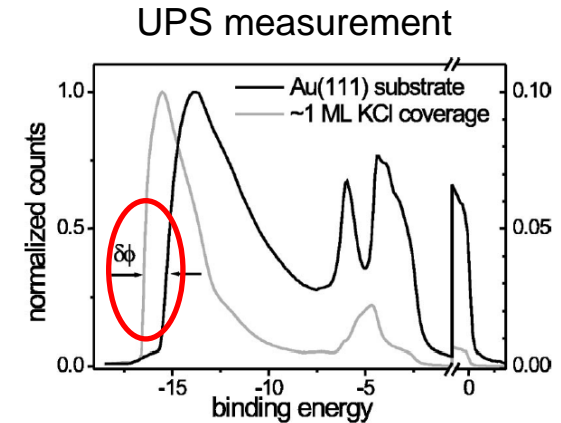
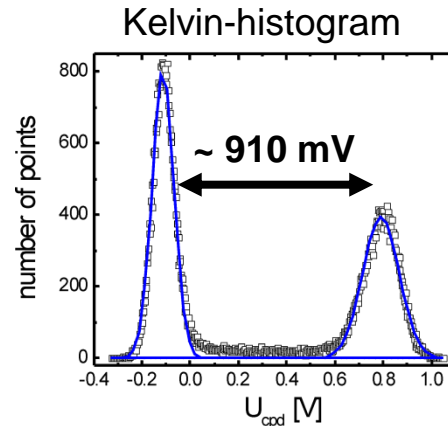
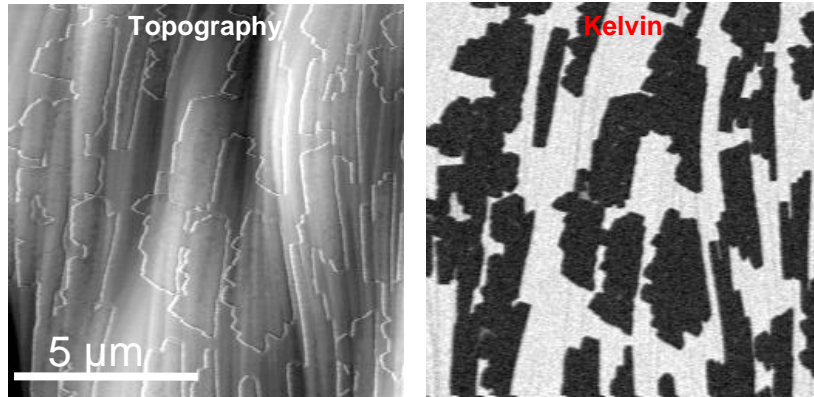

□ KCl islands decrease the CPD: interface dipole decreased

□ Quantitative measurement of the CPD in the LR regime when the adsorbates are larger than the tip radius

¹U. Zerweck *et al.*, Phys. Rev. B **71**, 125424 (2005);



KPFM on metallic surfaces including adsorbates:

Thin insulating inorganic films :

Ionic thin films on Au(111)¹ (FM-KPFM):

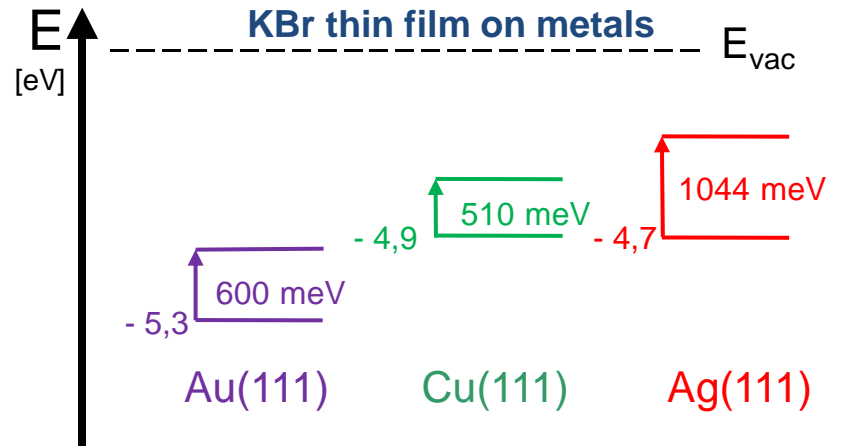
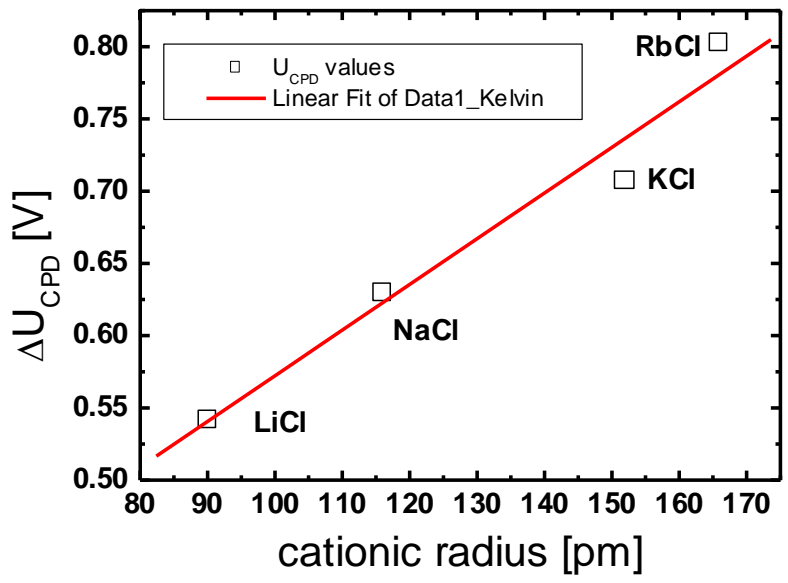

- Interface dipole varies with the nature of the metal
- Adsorption properties must change

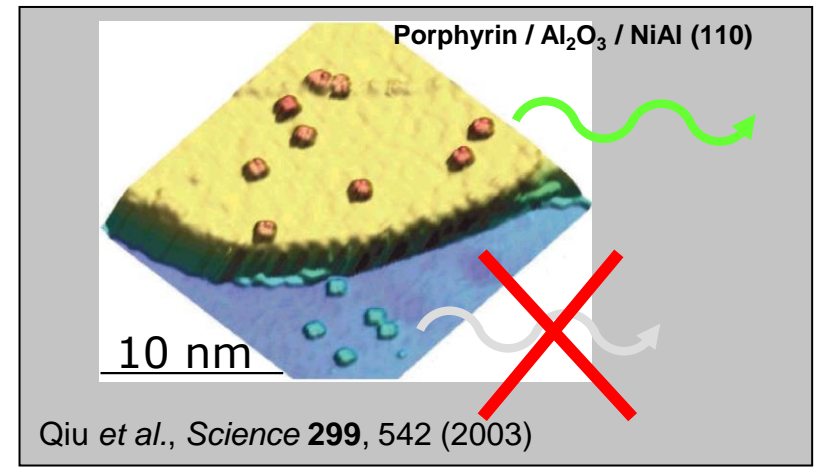

¹Ch. Loppacher et al., Nanotechnology 15, S9 (2004)



KPFM on metallic surfaces including adsorbates:

□ Molecular organic films :

CuPc on Au(111)¹ (FM-KPFM):

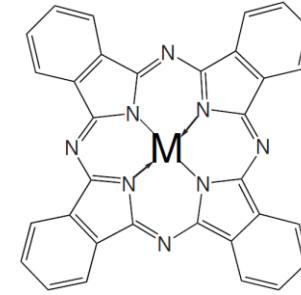
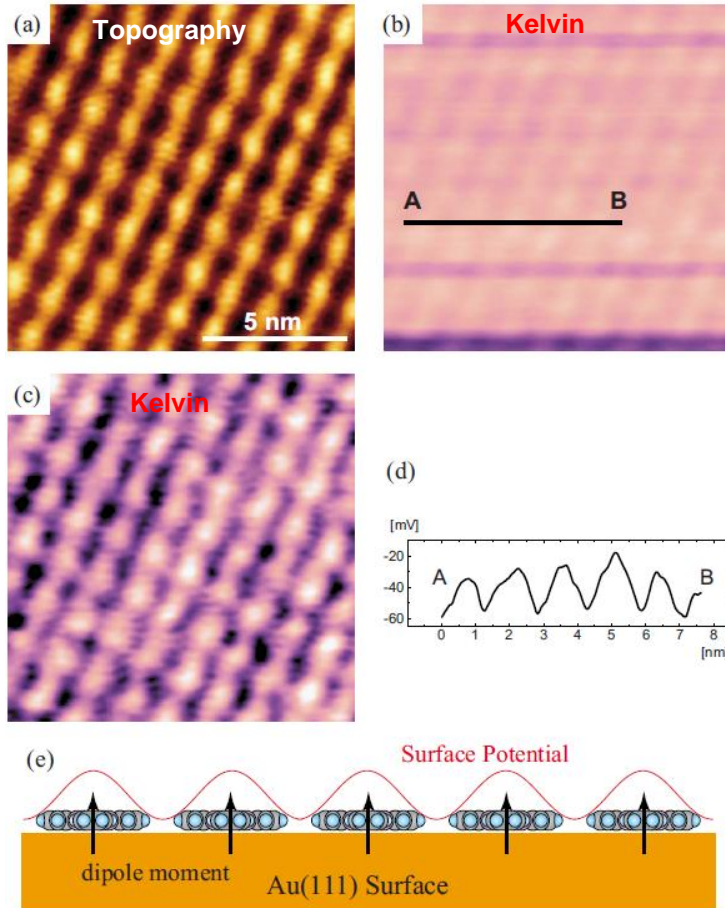

M=Cu, Co

- Molecular resolution in KPFM
- +30mV positive shift, increase of the interface dipole, c.t. to the layer
- Results interpreted in terms of electrostatic MS interaction

¹T. Ichii *et al.*, JAP **107** 024315 (2010);



KPFM on metallic surfaces including adsorbates:

□ Molecular organic films :

C_{60} on Ag(111)¹ (FM-KPFM):

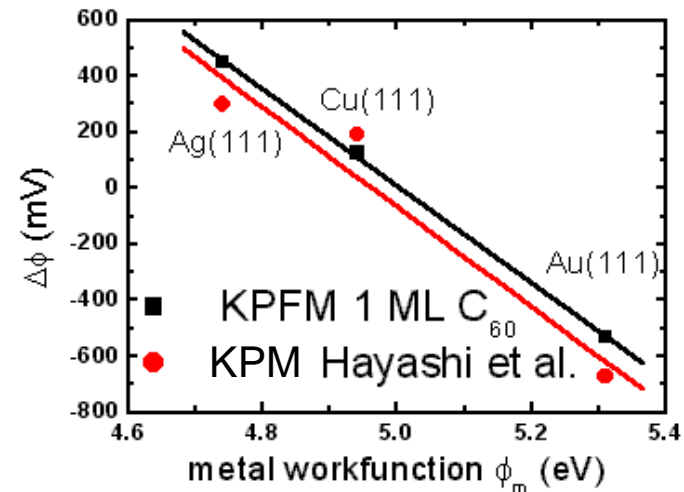
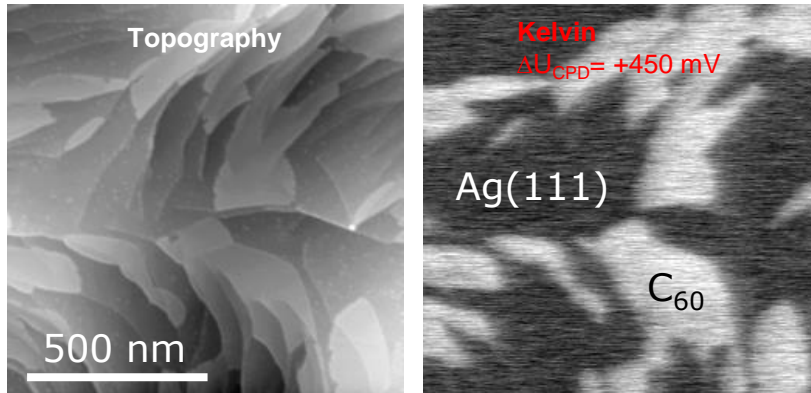

- C_{60} layers increase the LCPD: interface dipole increase, c.t. to the molecules
- Behavior depends on the nature of the metal
- Results are compliant with macroscopic KPM

¹U. Zerweck *et al.*, Nanotechnology **18** 084006 (07); Hayashi *et al.*, JAP **92**, 3784 (02)

KPFM on bulk insulators

□ Mixed ionic crystals¹: NaCl(001)+1% KCl (FM-KPFM)

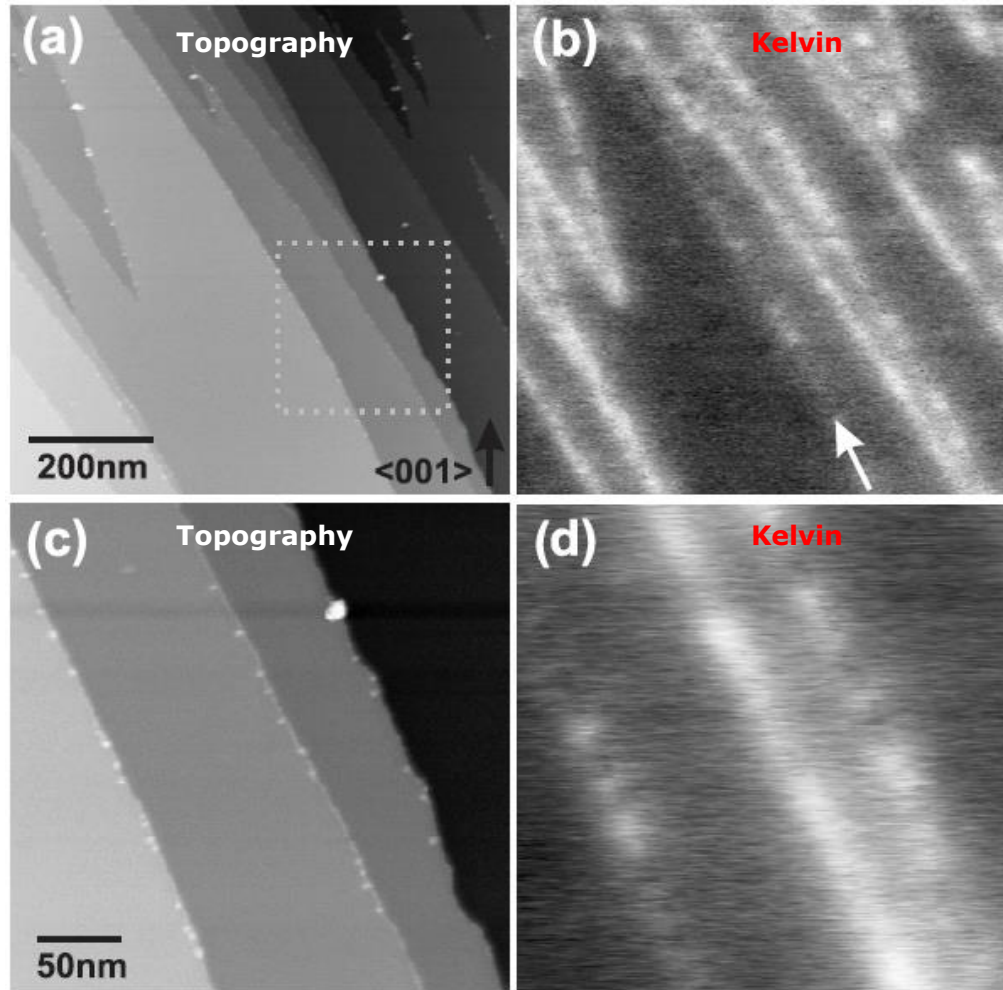

- Significant positive CPD shift at the step edges (+300 mV)
- Local (-) charges are heterogeneously trapped along the step edges : not intrinsic
- Similar behavior on other alkali halides (KCl)

Origin of these charges?

¹C. Barth *et al.*, *Nanotechnology* **17**, S155 (2006)

KPFM on bulk insulators

□ KCl(001)¹: (FM-KPFM)

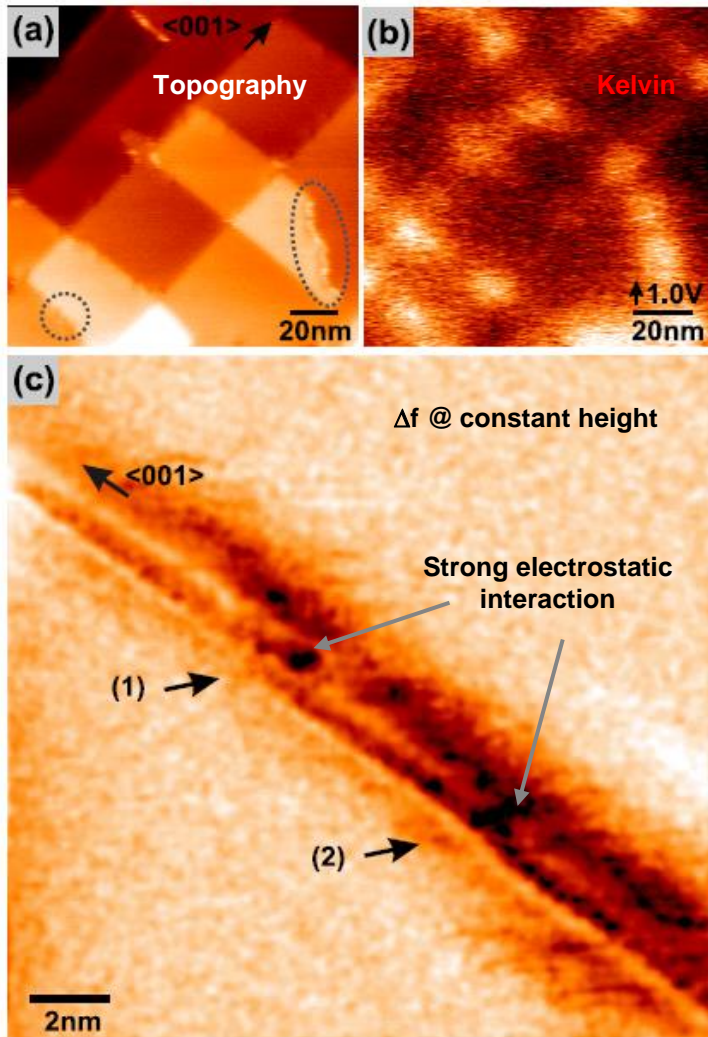

“Double layer surface” effect²

- Ionic crystals are extrinsic : Ca^{2+} impurities nearby steps below the surface
- Global charge of the crystal is neutral \rightarrow V^- centers (cationic vacancies)
- Net negative charge nearby (below) step edges and kink sites

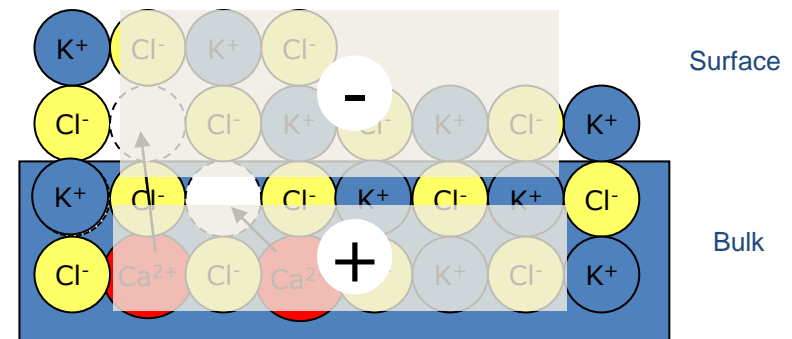

¹C. Barth *et al.*, *Phys. Rev. Lett.* 98, 136804 (2007); ²J. Frenkel, *Kinetic Theory of Liquids*, (Clarendon Press, Oxford, 1946).



KPFM on bulk insulators including molecular films

□ Triphenylene derivative on KBr(001)¹: (FM-KPFM)

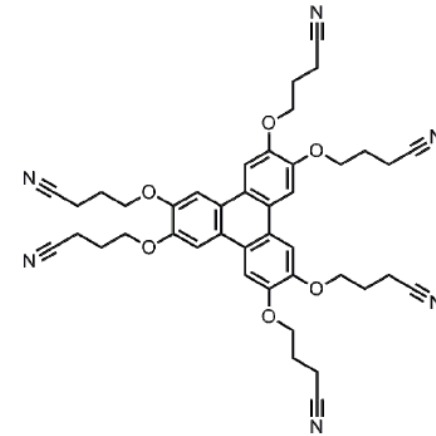
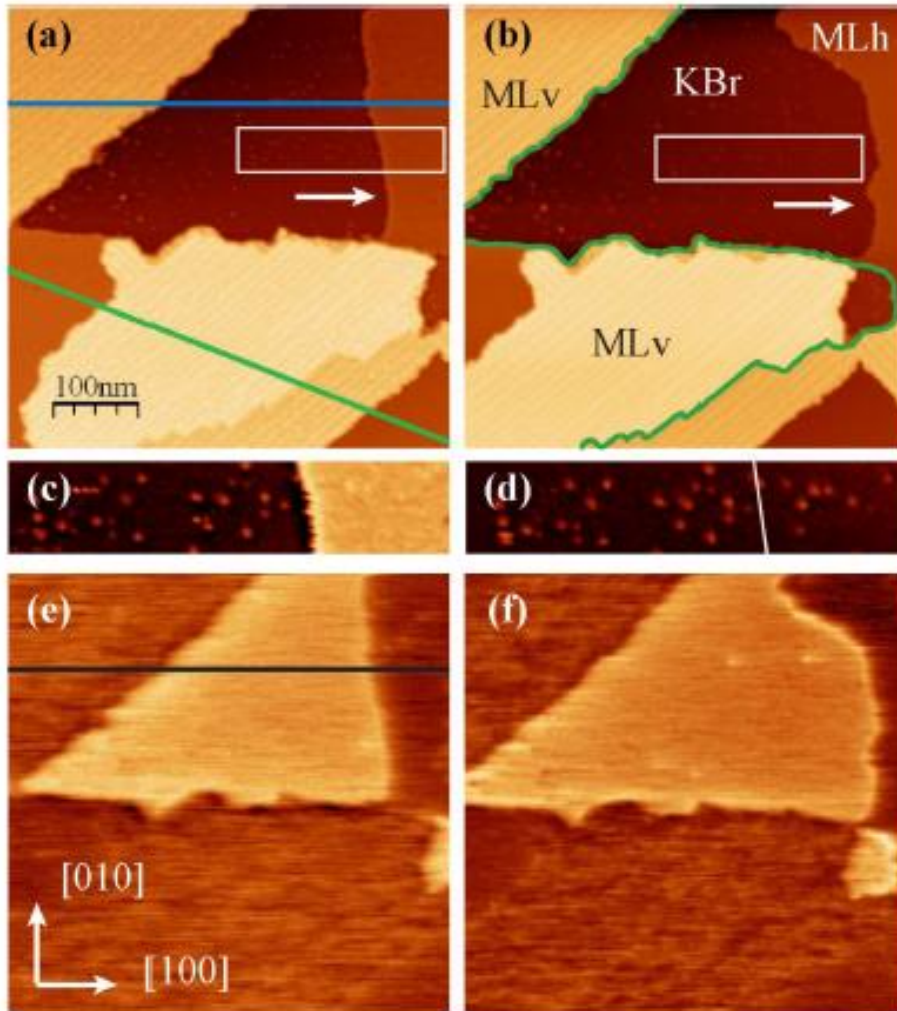

- Two kinds of adsorption: flat (h) and vertical (v)
- Both domains exhibit lower CPDs than KBr: surface dipole increase
- h-domains consist of molecules interacting electrostatically with the substrate via polar CN groups

¹A. Hinaut *et al.*, *J. Beilstein Nanotech.* **3**, 221 (2012)

KPFM on Transition Metal Dichalcogenides

B. Grévin, CEA, France:

Y. Luo *et al.*, *Adv. Mater.* **19**, 2267-2273 (2007); E. Spadafora *et al.*, *Nano Lett.* **10**, 3337 (2010); E. Spadafora *et al.*, *Appl. Phys. Lett.* **99**, 233102 (2011); F. Fuchs *et al.*, *Phys.Rev.B* **88**, 205423 (2013); F. Fuchs *et al.*, *ACS Nano* **10**, 739–746 (2016); B. Grévin *et al.*, *Beilstein J. Nanotechnol* **7**, 799 (2016); P.A. Fernández Garrillo *et al.*, *Beilstein J. Nanotechnol.* **9**, 1834–1843 (2018); B. Grévin *et al.*, *Beilstein J. Nanotechnol.* **11**, 323–337 (2020); V. Aubriet *et al.*, *Nanotechnology* **33**, 225401 (2022); A. Arrighi *et al.*, *Nanotechnology* **34**, 215705 (2023)



Experimental developments

Original approaches :

- SPV measurements
- time-resolved CPD/SPV (pump probe)
- Data cube

Applied physics
(conductive polymers, heterojunctions for photovoltaics, perovskites, TMD)

Quantitative measurements
(artefacts-free)

KPFM on Transition Metal Dichalcogenides

□ $\text{MoS}_2/\text{SiO}_2/\text{Si}^1$: (Heterodyne AM-KPFM)

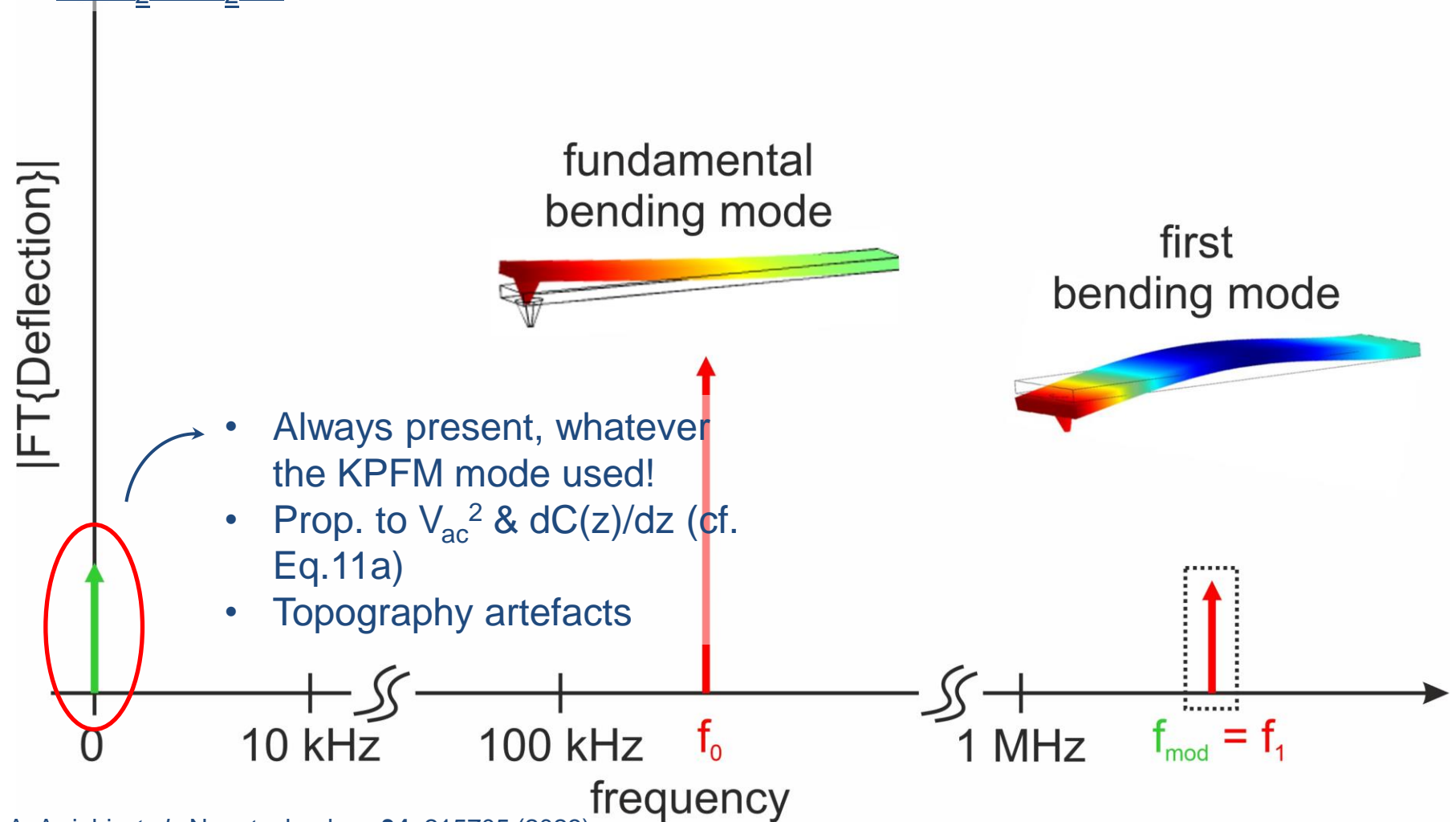

A. Arrighi *et al.*, Nanotechnology **34**, 215705 (2023)

KPFM on Transition Metal Dichalcogenides

□ MoS₂/SiO₂/Si¹: (Heterodyne AM-KPFM)

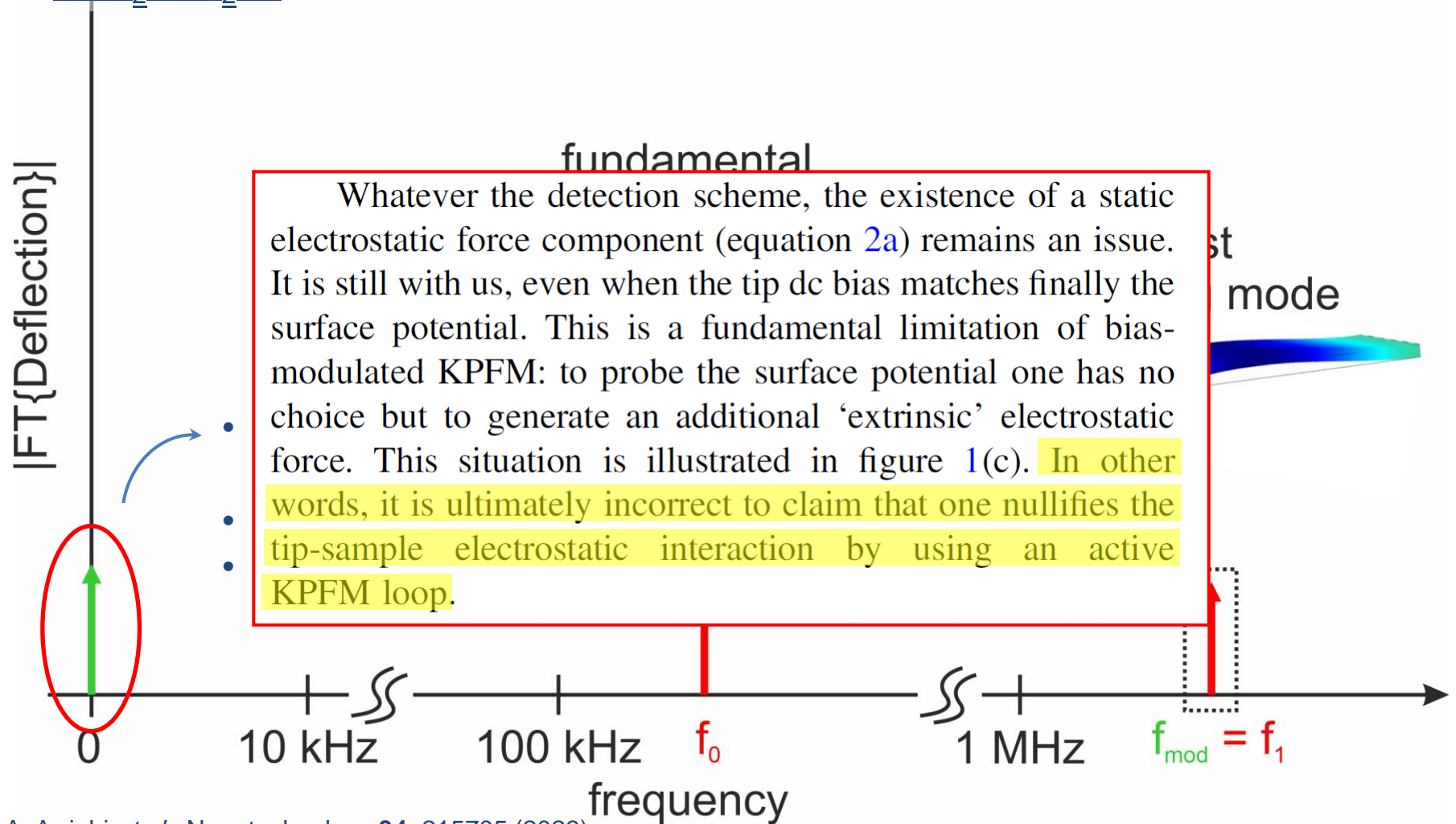

A. Arrighi *et al.*, *Nanotechnology* **34**, 215705 (2023)

KPFM on Transition Metal Dichalcogenides

□ MoS₂/SiO₂/Si¹: (Heterodyne AM-KPFM)

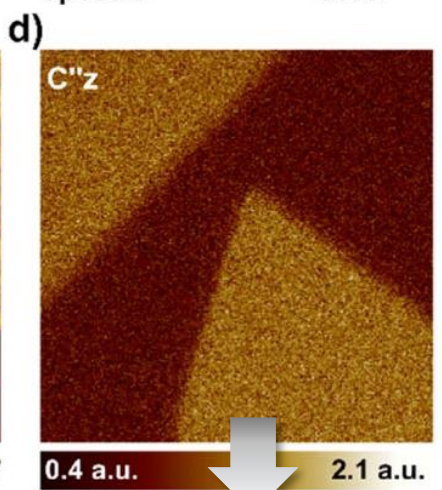
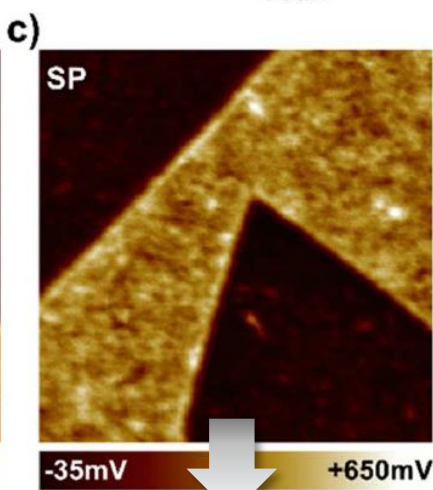
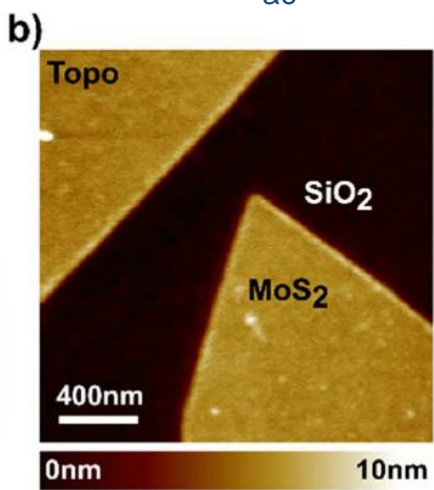
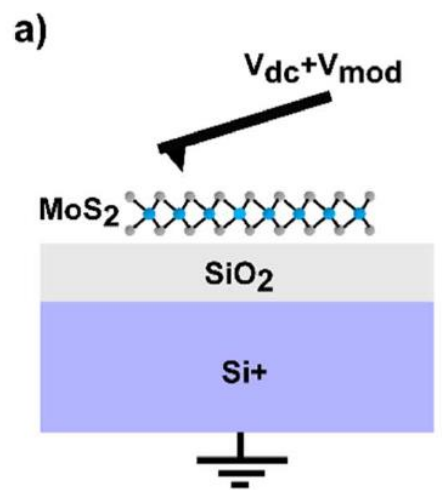
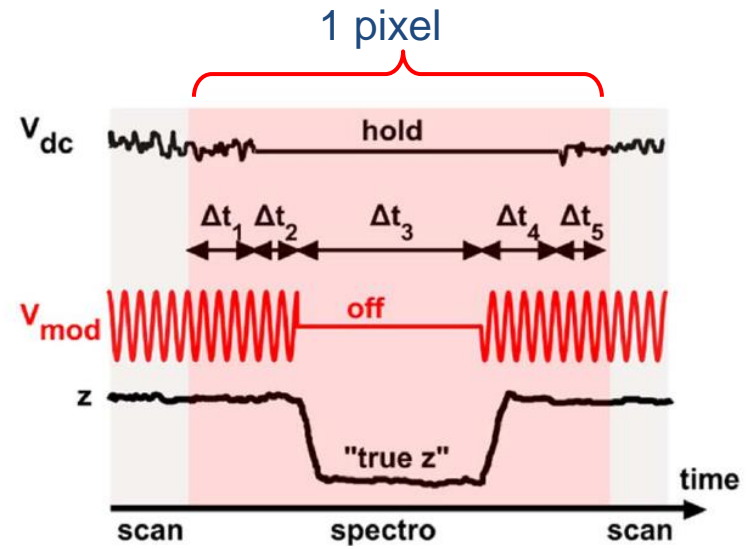
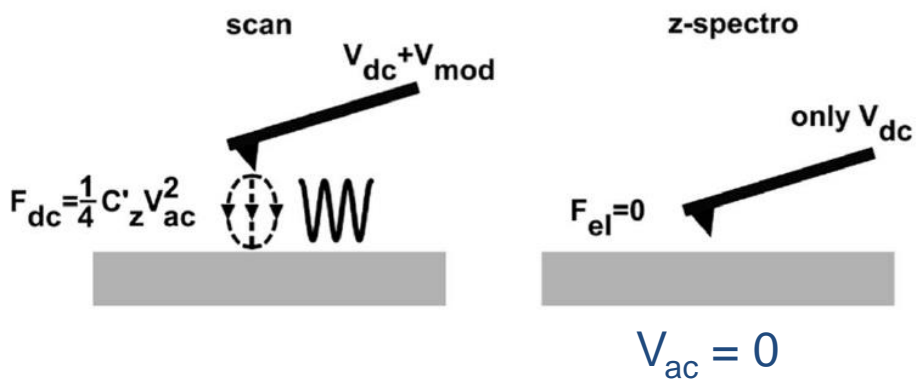

A. Arrighi *et al.*, Nanotechnology **34**, 215705 (2023)

Demodulation : $f_{mod} = f_1 - f_0$ $2f_{mod}$

IV. Examples of applications

- Long-range regime

- Short-range regime

High-resolution KPFM: semiconductor surfaces

- S. Kitamura *et al.*, Appl. Surf. Sci. **157**, 222 (2000) : Au/Si(111) 7x7

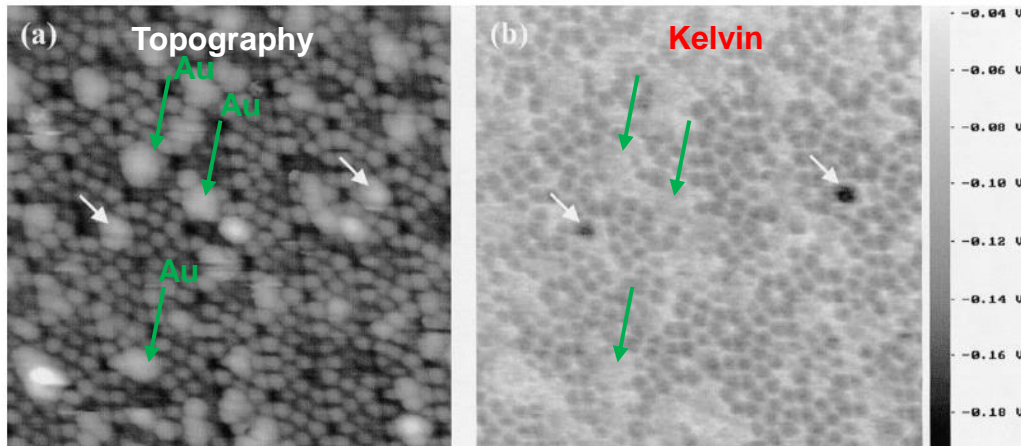

"The potential difference of atomic structures...**does not seem to reflect the work function** as we initially expected. It is therefore considered that the atomic potential difference reflects the local electron density on the surface."

- K. Okamoto *et al.*, Appl. Surf. Sci. **210**, 128 (2003) : Si(111)5 $\sqrt{3}$ 5 $\sqrt{3}$ -Sb

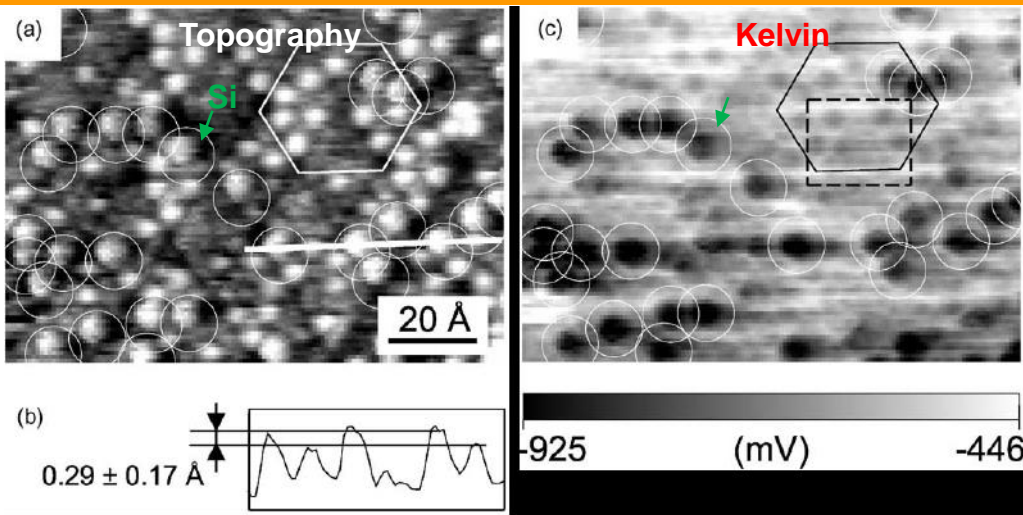

First attempt to identify species of individual atoms by KPFM

Potential of adatoms (surface potential) : $V_{\text{Si}} \sim V_{\text{Sb}} - 0.2\text{V}$
 : "This value disagrees with the theoretical work functions of Si and Sb in bulk state...Our result indicates that KPFM on atomic scale does not measure the energy of the HOMO level."

High-resolution KPFM: intramolecular resolution

nature
nanotechnology

LETTERS

PUBLISHED ONLINE: 26 FEBRUARY 2012 | DOI: 10.1038/NNANO.2012.20

Imaging the charge distribution within a single molecule

Fabian Mohn*, Leo Gross, Nikolaj Moll and Gerhard Meyer

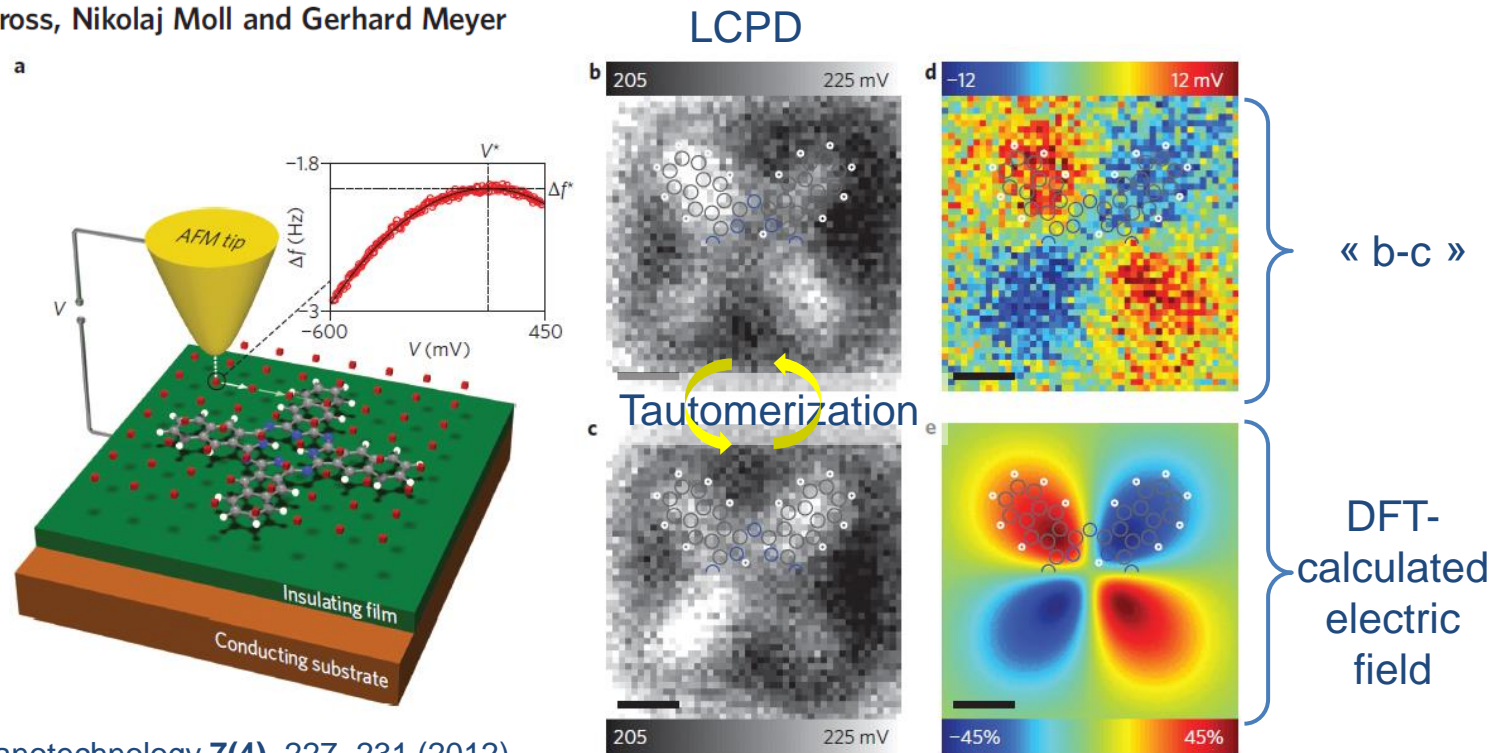

F.Mohn *et al.* Nature Nanotechnology **7(4)**, 227–231 (2012)

High-resolution KPFM: charge state of individual atoms

Measuring the Charge State of an Adatom with Noncontact Atomic Force Microscopy

Leo Gross,^{1*} Fabian Mohn,¹ Peter Liljeroth,^{1,2} Jascha Repp,^{1,3} Franz J. Giessibl,³ Gerhard Meyer¹
12 JUNE 2009 VOL 324 SCIENCE

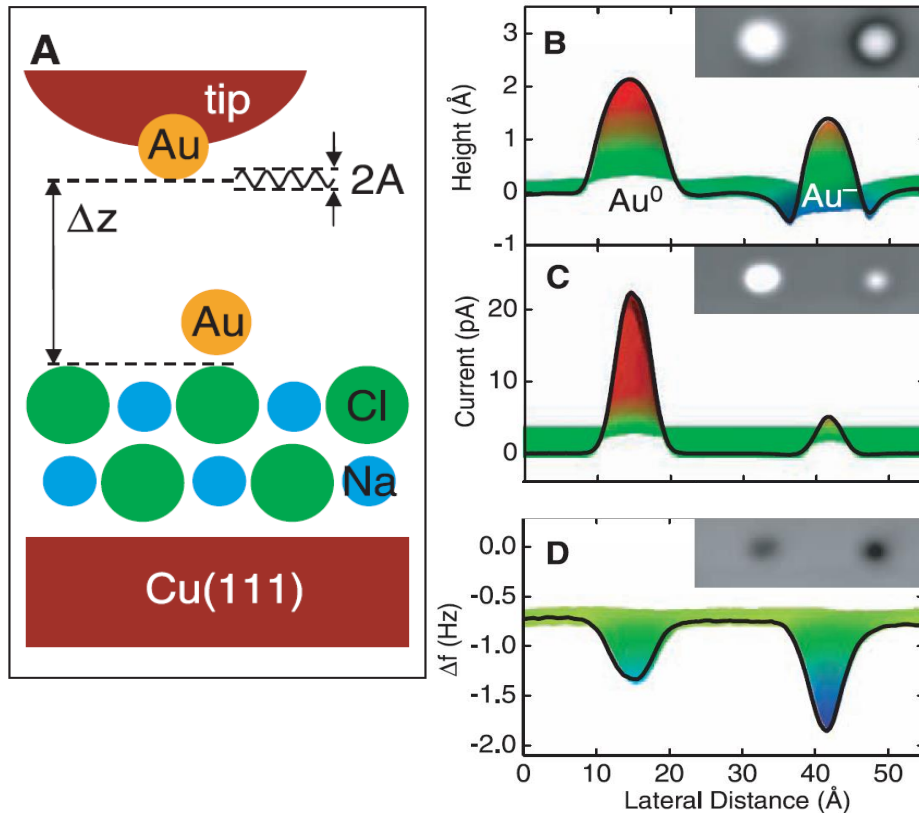

Topographic sensitivity to the charge state on the atomic scale

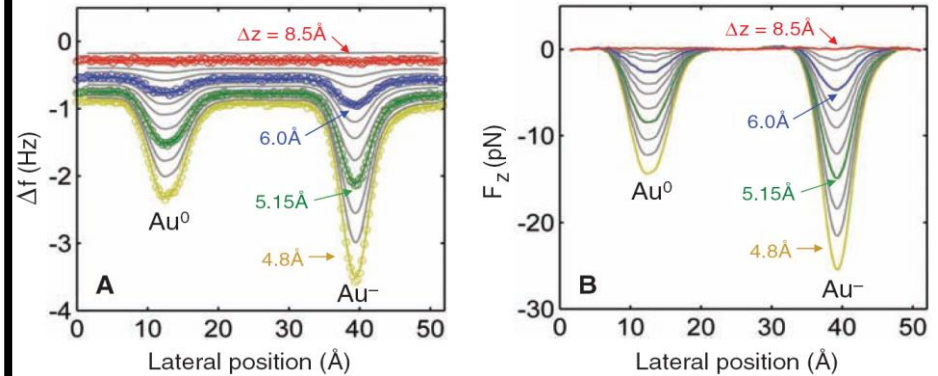

Spectroscopic sensitivity to the charge state on the atomic scale

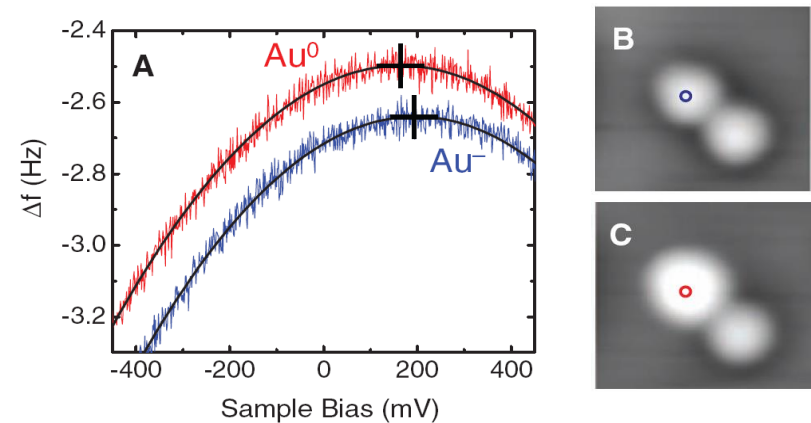

High-resolution KPFM: modelling

1

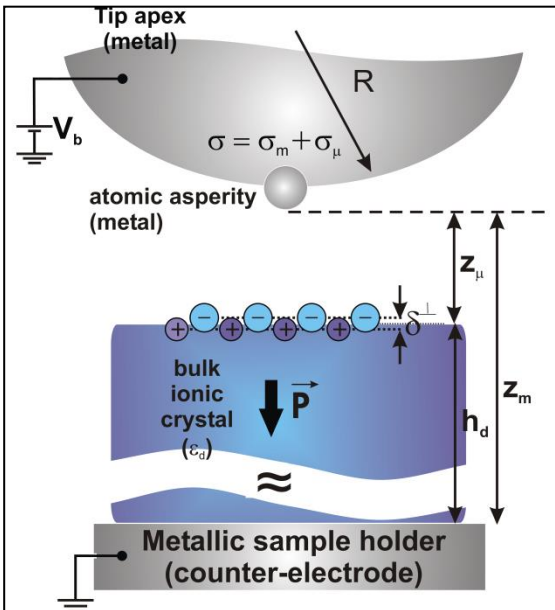

- **Tip termination:** metallic atomic asperity
- **Sample:** Bulk ionic crystal
- **Analytical & Experimental approach**

F.Bocquet et al., Phys. Rev. B **78**, 035410 (2008)

L.Nony et al., Nanotechnology **20**, 264014 (2009)

2

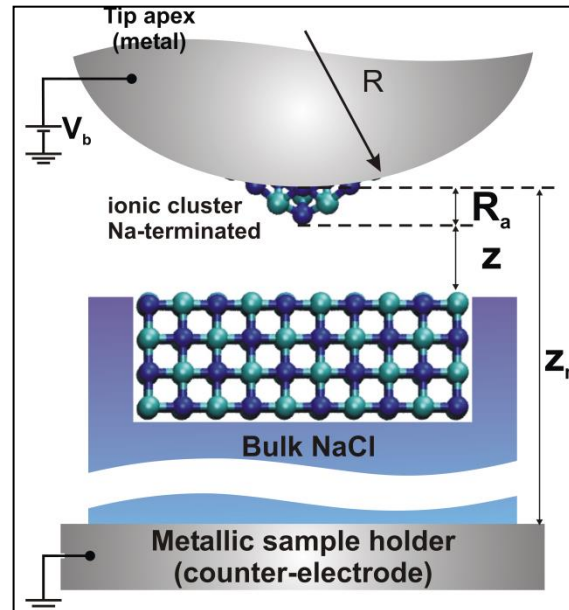

- **Tip termination:** ionic cluster (Na⁺-terminated)
- **Sample:** Bulk ionic crystal
- **Fully numerical approach**

L.Nony et al., Phys. Rev. Lett. **103**, 036802 (2009)

3

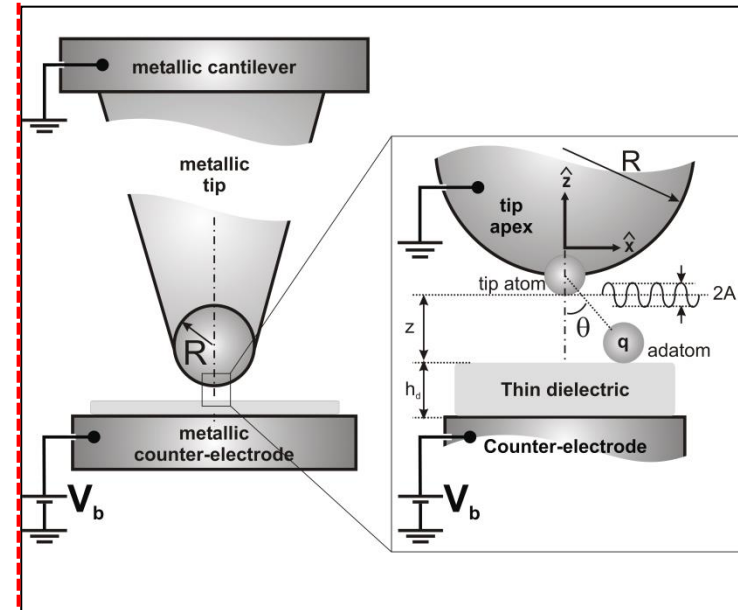

- **Tip termination:** single metallic atom
- **Sample:** 2ML NaCl / Cu(111)
- **Fully analytical approach**

F.Bocquet et al., Phys.Rev.B **83**, 035411 (2011)
Based upon the work by L.Gross et al. Science **324**, 1428 (2009)

Charge state of a single atom

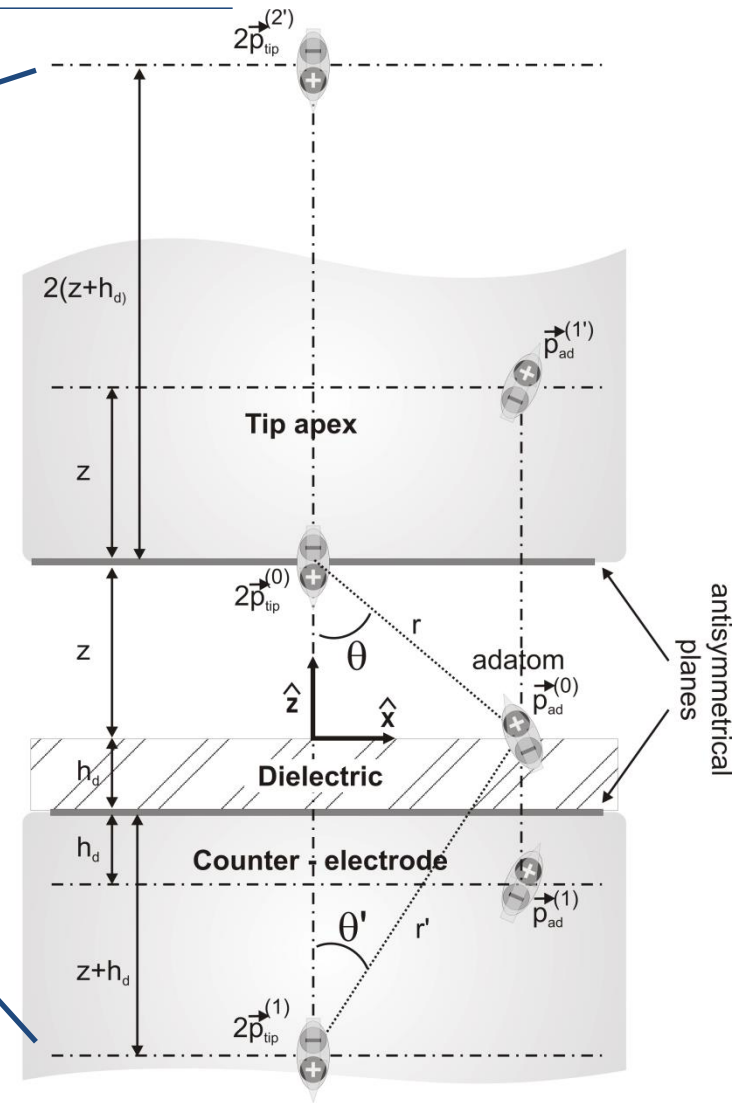
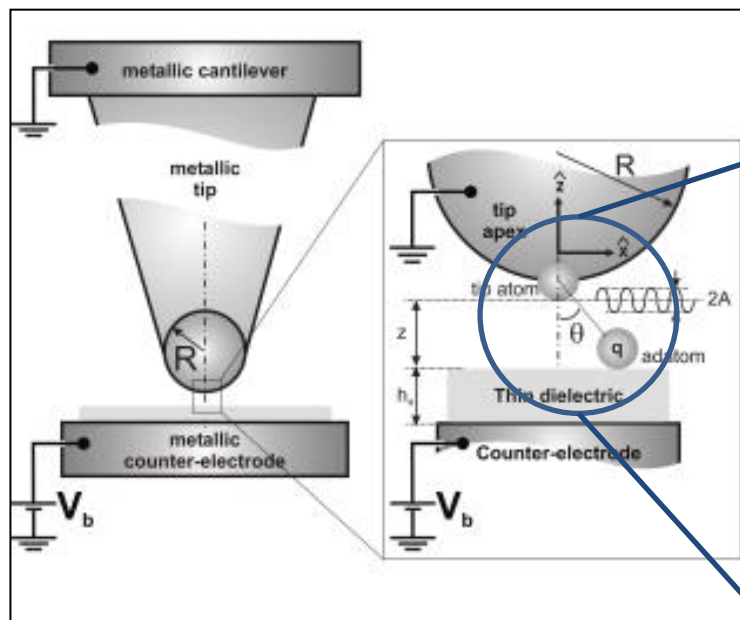

$$F_{SR}^{el} = - \frac{\partial}{\partial z} \left[- \frac{1}{2} \vec{p}_{tip} \cdot \vec{E}_{tip}^{ext} - \frac{1}{2} \vec{p}_{ad} \cdot \vec{E}_{ad}^{ext} \right]$$

Electrostatic energy of polarization-induced dipoles

Charge state of a single atom

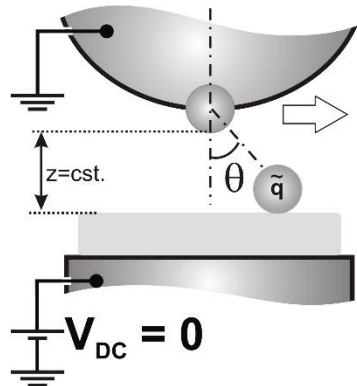

Polarizability for Gold: $\alpha=6.78\text{\AA}^3$

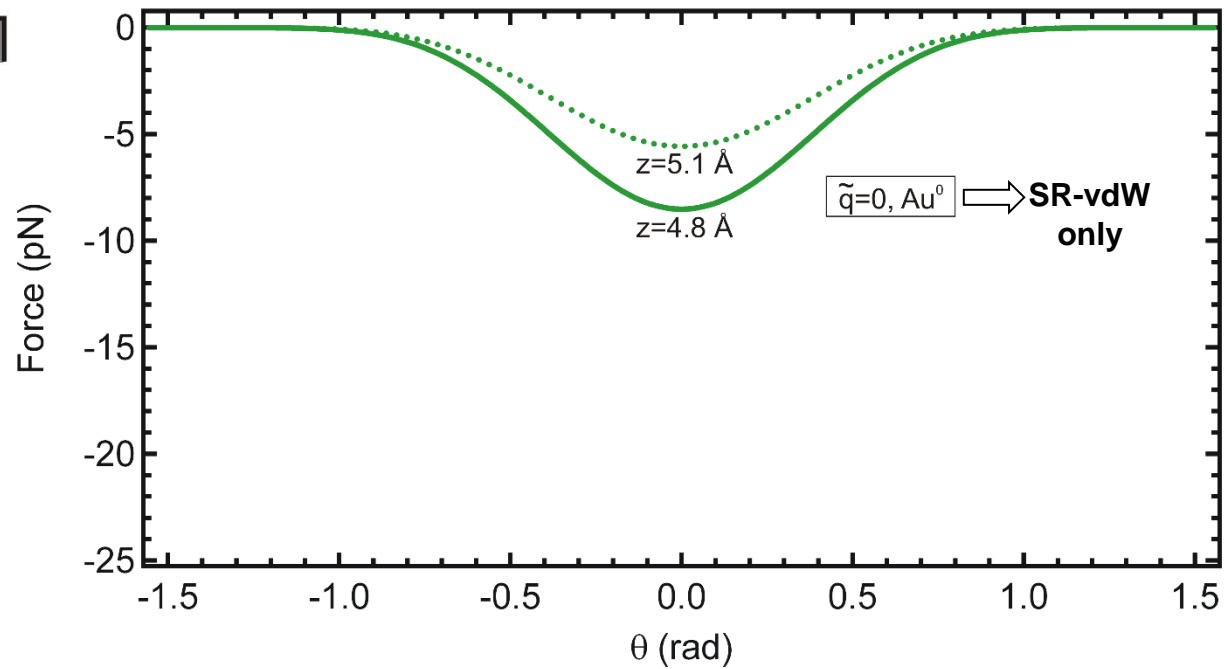

Charge state of a single atom

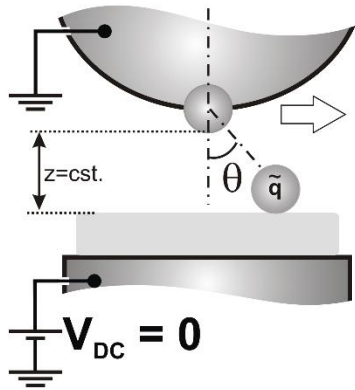

Polarizability for Gold: $\alpha = 6.78 \text{ \AA}^3$

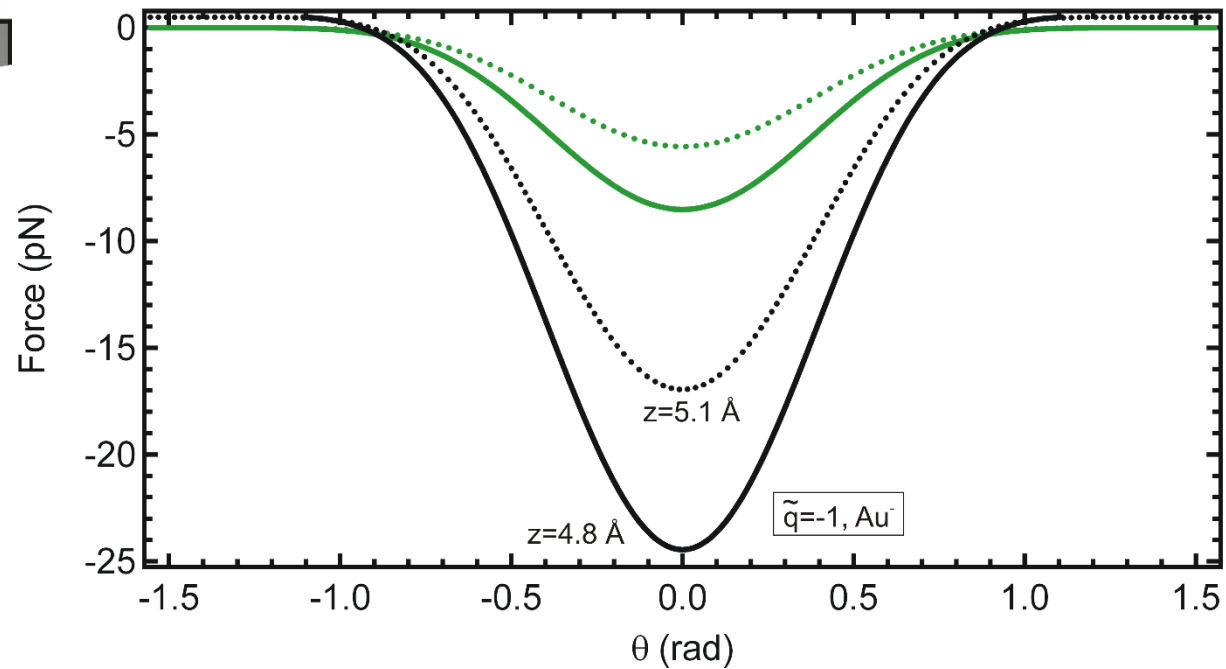

Charge state of a single atom

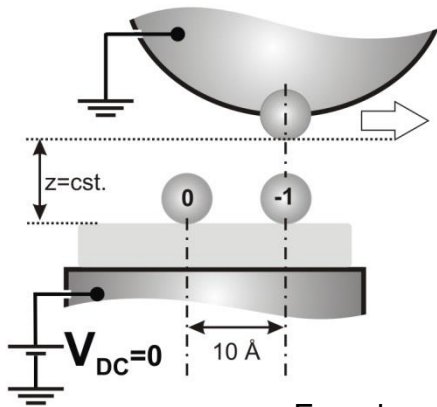

$$\text{Force} \rightarrow \Delta f = -\frac{f_0}{2k} \frac{\partial F}{\partial z}$$

Δf derived from the total force (LR+SR components, $z = 5.1 \text{ \AA}$, $R = 50 \text{ \AA}$)

Experimental data by L.Gross et al.

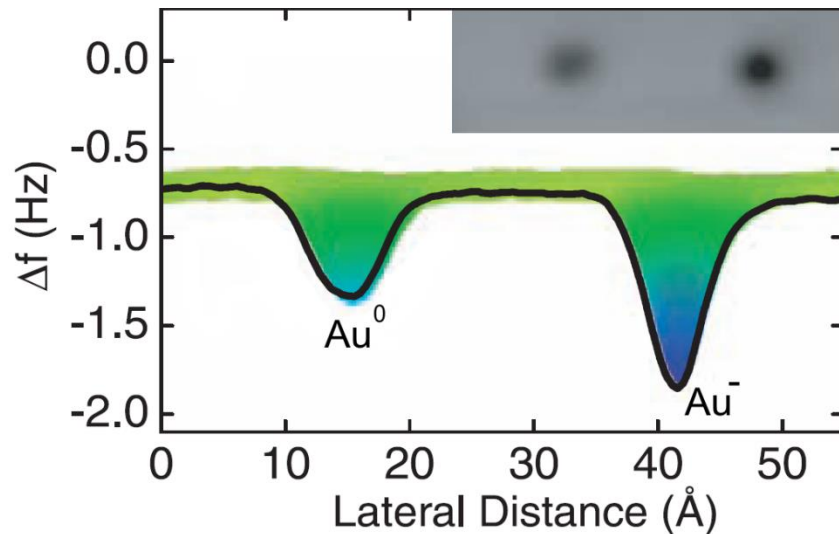

Cross section derived from the model

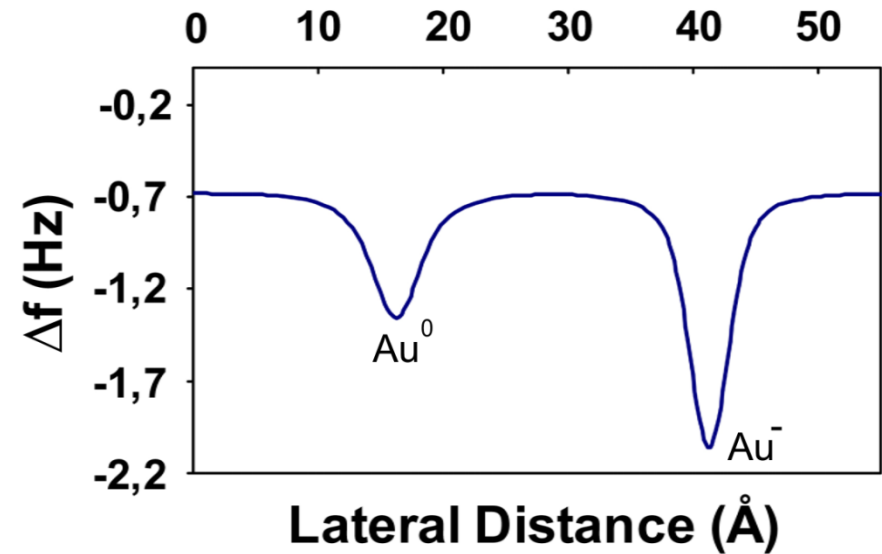

Charge state of a single atom

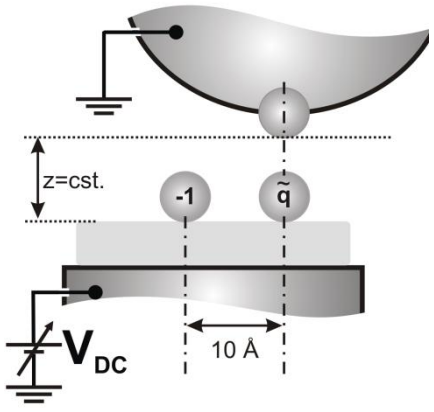

$$\text{Force} \rightarrow \Delta f = -\frac{f_0}{2k} \frac{\partial F}{\partial z}$$

Δf derived from the total force (LR+SR components, $z = 5.8 \text{ \AA}$, $R = 50 \text{ \AA}$)

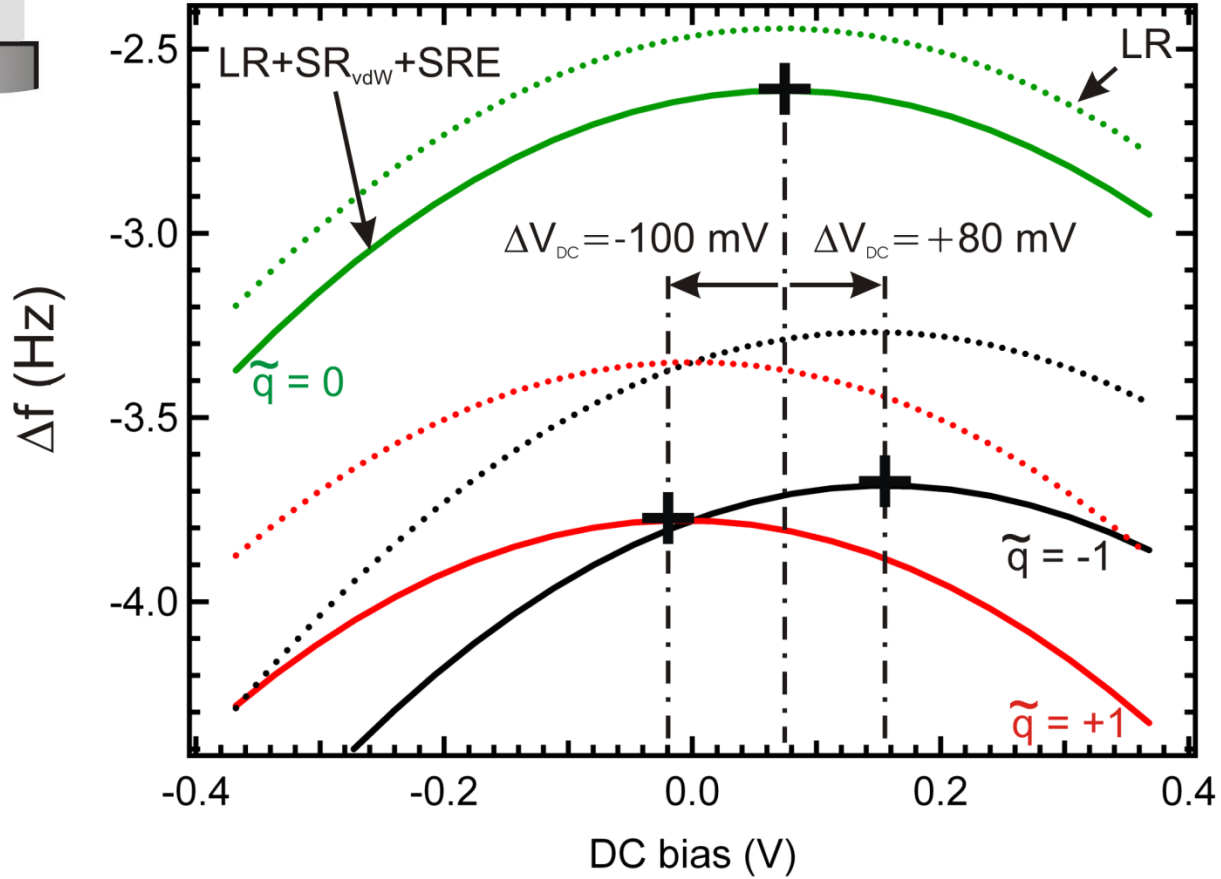

4D KPFM spectroscopy

a-

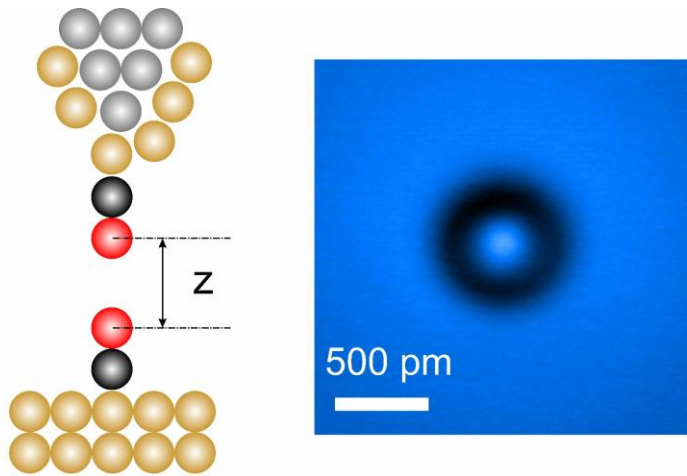

b-

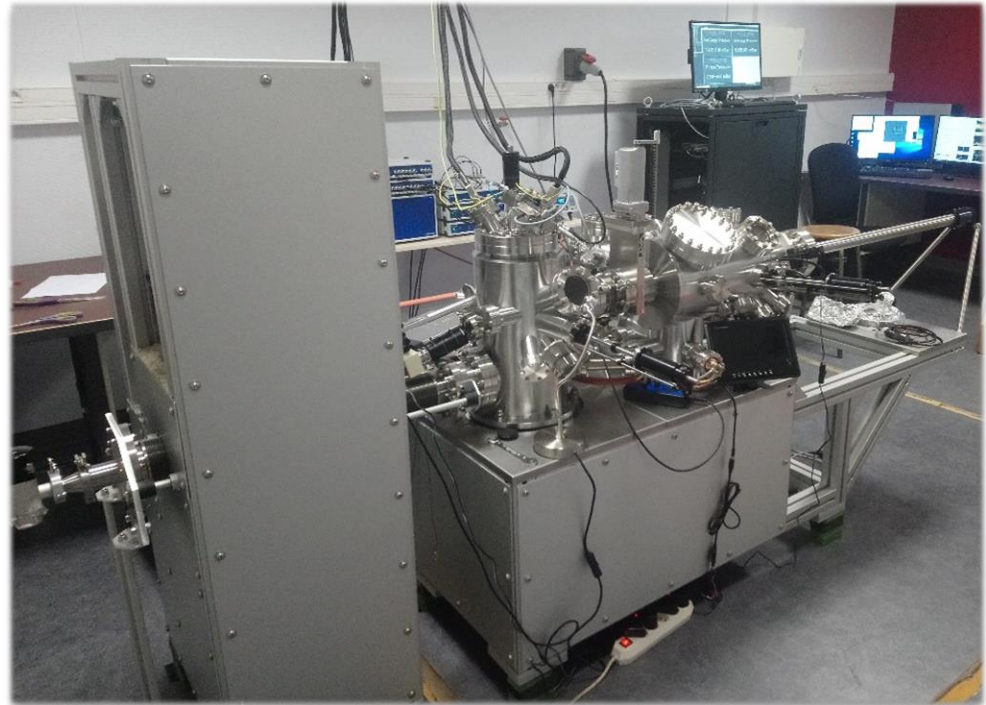
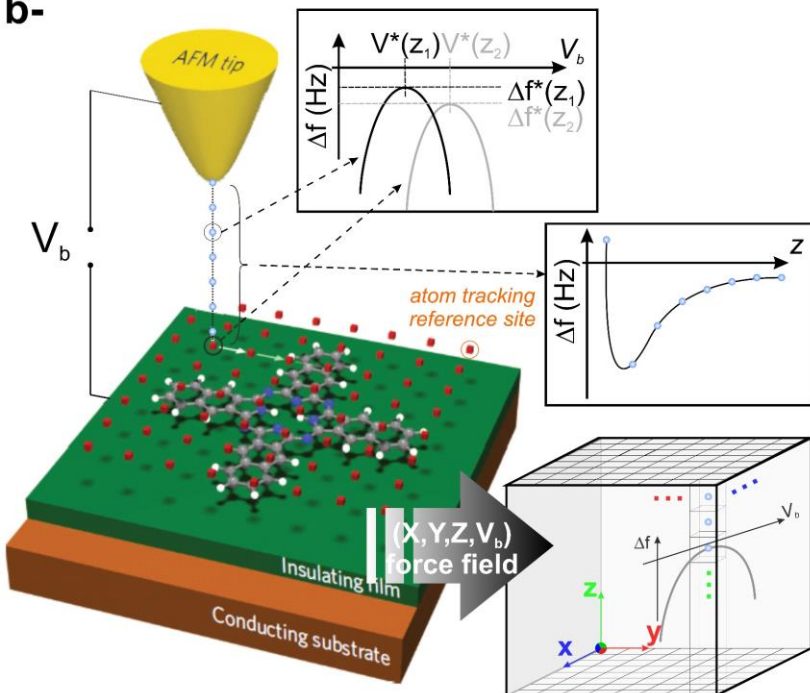

LT-SPM Infinity (Σ Surf.Science/Scienta Omicron, Dec.2019):

- 8.7 K (cryo-free closed cycle, pulse tube cooler)
- STM / nc-AFM:
 - Quartz tuning fork, qPlus™
 - $A_{0,\min} \sim 50$ pm
 - Mean Z (topo.) noise ~ 1 pm
 - SPECS MIMEA control unit

4D KPFM spectroscopy

a-

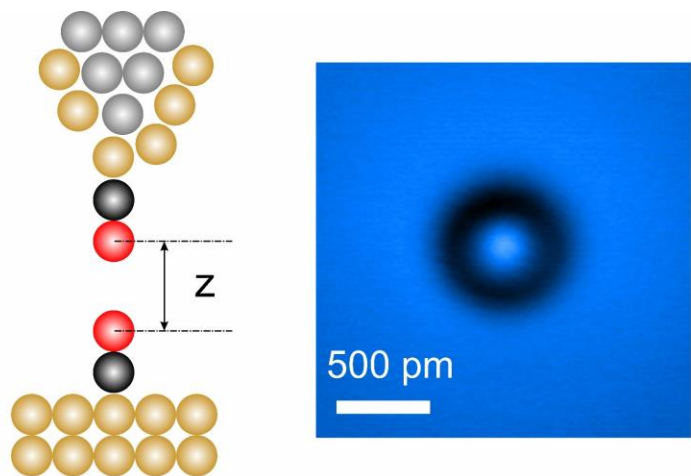

b-

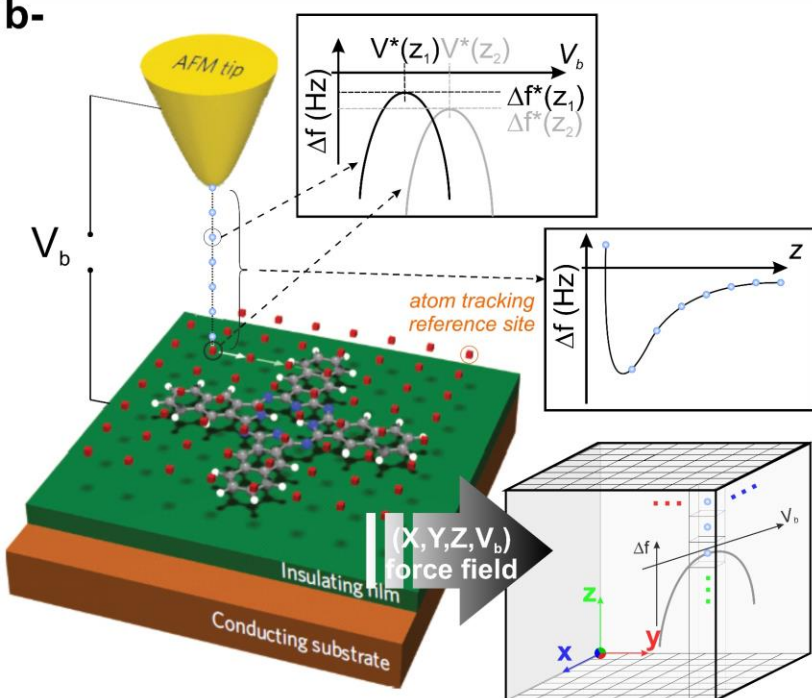

c-

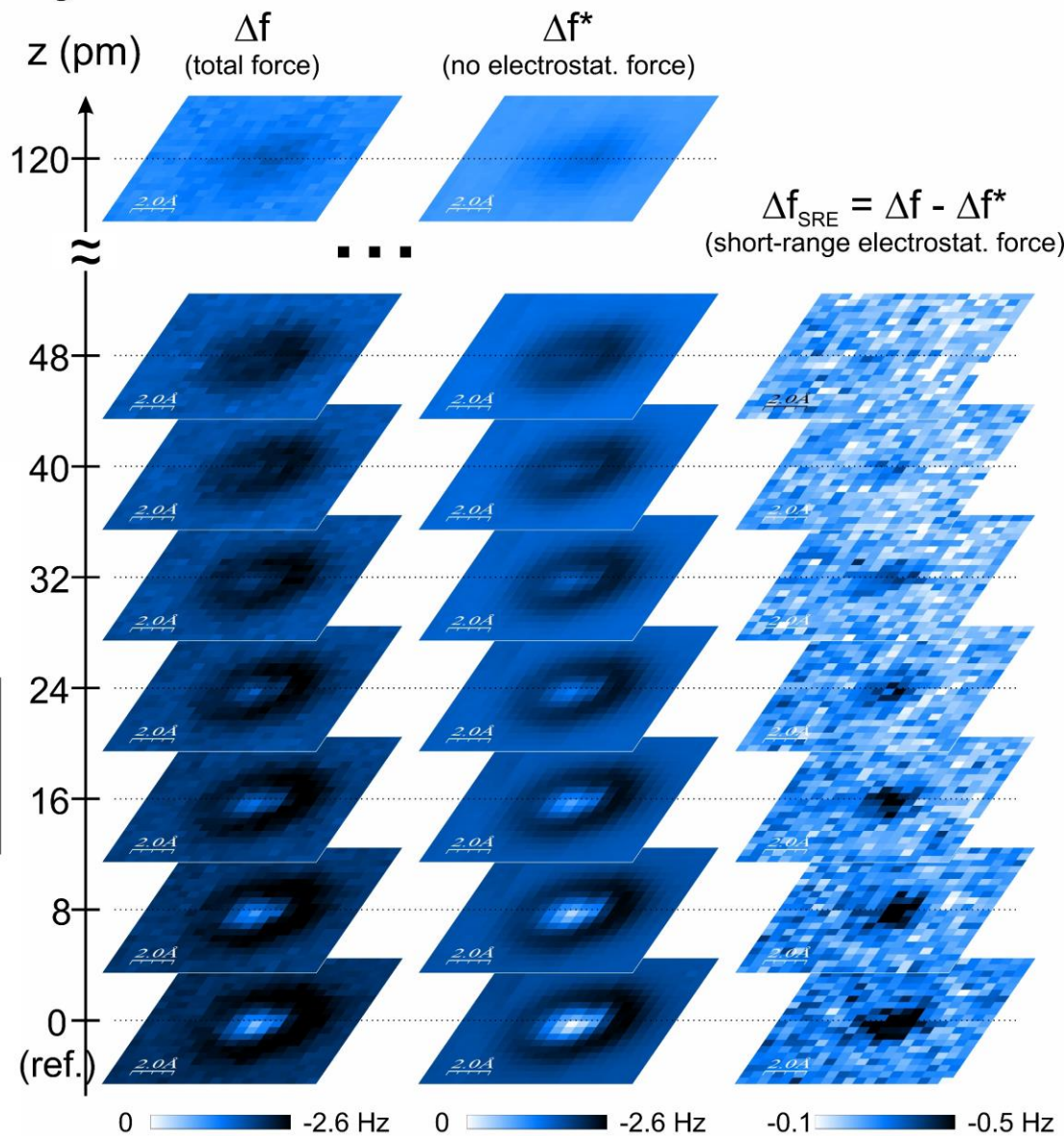

Outline

I. INTRODUCTION to KPFM

II. CONCEPTS & IMPLEMENTATIONS

III. ELECTROSTATIC MODELS



IV. EXAMPLES OF APPLICATIONS



CONCLUSION

Some references...

Conclusion

Take home message

- ❑ Compensation of F^{el} is required for AFM imaging in general and high-resolution nc-AFM imaging specifically → need for KPFM
- ❑ Technic is implemented according to several setups that add further complexity to the experimental setup, but...
- ❑ The sign of the charges / dipole orientation of the species trapped within the capacitance that shift the CPD w.r.t. CPD_{ref} (background) is easy to determine
- ❑ In the long-range regime and with surface adsorbates whose size is larger than the tip apex, KPFM yields a consistent CPD map of the sample (consistent with UPS measurements)
- ❑ BUT getting quantitative numbers out of the experimental data is difficult (requires models) as the CPD is tip geometry and distance dependent
- ❑ KPFM in the short-range regime is sensitive to short-range electrostatic forces, whose effects can qualitatively be understood as electronic & ionic polarizability-induced

Outline

I. INTRODUCTION to KPFM

II. CONCEPTS & IMPLEMENTATIONS

III. ELECTROSTATIC MODELS



IV. EXAMPLES OF APPLICATIONS



CONCLUSION

Some references...

Some references...

- B.D. Terris *et al.*, *Phys. Rev. Lett.* **63**, 2669 (1989)
- H. Jacobs *et al.*, *J. Appl. Phys.* **84**, 1168 (1998)
- J. Colchero *et al.*, *Phys. Rev. B* **64**, 245403 (2001)
- A. Gil *et al.*, *Nanotechnology* **14**, 332 (2003)
- Y. Azuma *et al.*, *Phys. Rev. Lett.* **96**, 016108 (2006)
- K. Sajewicz *et al.*, *Jap. J. Appl. Phys.* **49**, 025201 (2010)
- **IBM Zurich lab.**: L. Gross *et al.*, *Science* **324** :1428–1431 (2009); F. Mohn *et al.*, *Nature Nanotechnology* **7**(4), 227–231 (2012); B. Schuler *et al.*, *Nano Letters* **14**, 3342-3346 (2014); F. Albrecht *et al.* *Phys. Rev. B* **92**, 235443 (2015) ...
- **C. Barth**, CINaM, France: C. Barth *et al.*, *New J. Phys.* **12**, 093024 (2010); B. Hoff *et al.*, *J. Phys. Chem. C* **118**, 14569 (2014); E. Palacios-Lidon *et al.*, *ACS Catalysis* **4**, 1838 (2014); B. Hoff *et al.*, *Nanoscale* **8**, 411-419 (2016)...
- **E. Meyer group**, Uni. Basel, Switzerland: T. Glatzel *et al.*, *Appl. Surf. Sci.* **210**, 84 (2003); S. Kawai *et al.* *Nanotechnology* **21**, 245704 (2010); R. Pawlak *et al.*, *Nano Lett.* **13**, 5803-5807 (2013); A. Henning *et al.*, *Beilstein J. Nanotechnol.* **4**, 418-428 (2013); B. Eren *et al.*, *Appl. Phys. Lett.* **108**, 041602 (2016); T. Glatzel *et al.*, *Microscopy* **71**(S1), i165–i173 (2022)...
- **T. Mélin**, IEMN, France: T. Mélin *et al.*, *Phys. Rev. Lett.* **92**, 166101 (2004); S. Barbet *et al.*, *J. Appl. Phys.* **115**, 144313 (2014); H. Diesinger *et al.*, *Beilstein J. Nanotechnol.* **5**, 1-18 (2014); E. Palleau *et al.*, *Nanotechnology* **21**, 225706 (2010); H. Diesinger *et al.*, *Ultramicroscopy* **110**, 162-169 (2010)...
- **S. Sadewasser**, INL Portugal: S. Sadewasser *et al.*, *Phys. Rev. Lett.* **103**, 266103 (2009); R. Baier *et al.*, *Phys. Rev. B* **85**, 165436 (2012); F. Mesa *et al.*, *J. Nanotechnol.* **3**, 277-284 (2012)...
- **P. Grütter group**, Mc Gill, Canada: R. Stomp *et al.*, *Phys. Rev. Lett.* **94**, 056802 (2005); S.A. Burke *et al.*, *Nanotechnology* **20**, 264012 (2009); Y. Miyahara *et al.* *Phys. Rev. Appl.* **4**, 054011 (2015); Z. Schumacher *et al.*, *Phys. Rev. Appl.* **5**, 044218 (2016); Z. Schumacher *et al.*, *Appl. Phys. Lett.* **110**, 053111 (2017); A. Mascaro *et al.*, *Beilstein J. Nanotechnol.* **10**, 617–633 (2019).

Some references...

- **P. Jelineck group**, Praha, Czech Rep.: F. Albrecht *et al.*, Phys. Rev. Lett. **115**, 076101 (2015); M. Ondráček *et al.*, Nanotechnology **27**, 274005 (2016); P. Hapala *et al.*, Nat. Commun. **7**, 11560 (2016); B. Mallada *et al.*, Science **374**, 863–867 (2021)
- **S. Kalinin group**, Oak Ridge Lab. (USA): L Collins *et al.*, Nanotechnology **24**, 475702 (2013); L. Collins *et al.*, Nanotechnology **29** 445703 (2018)
- T. Wagner *et al.*, Beilstein J. Nanotechnol. **6**, 2193–2206 (2015)
- J. Murawski *et al.*, J. Appl. Phys. **118**, 154302 (2015);
- A. Axt *et al.*, Beilstein J. Nanotechnol. **9**, 1809–1819 (2018)
- R. Borgani, and David B. Haviland, Rev. Sci. Instrum. **90**, 013705 (2019);
- R. Izumi *et al.*, Beilstein J. Nanotechnol. **14**, 175–189 (2023)
- S. Gu *et al.*, Nanoscale **15**, 5825–5833 (2023)

