



HAL
open science

Theoretical investigation on combustion heterogeneity in interior ballistics of mortar using Population Balance Equation

Matthias Pautard, Christian Chauveau, Fabien Halter, Christophe Coulouarn

► To cite this version:

Matthias Pautard, Christian Chauveau, Fabien Halter, Christophe Coulouarn. Theoretical investigation on combustion heterogeneity in interior ballistics of mortar using Population Balance Equation. *International Journal of Energetic Materials and Chemical Propulsion*, 2024, 23 (2), pp.39-47. 10.1615/IntJEnergeticMaterialsChemProp.2023048571 . hal-04357382

HAL Id: hal-04357382

<https://cnrs.hal.science/hal-04357382>

Submitted on 2 May 2024

HAL is a multi-disciplinary open access archive for the deposit and dissemination of scientific research documents, whether they are published or not. The documents may come from teaching and research institutions in France or abroad, or from public or private research centers.

L'archive ouverte pluridisciplinaire **HAL**, est destinée au dépôt et à la diffusion de documents scientifiques de niveau recherche, publiés ou non, émanant des établissements d'enseignement et de recherche français ou étrangers, des laboratoires publics ou privés.

THEORETICAL INVESTIGATION ON COMBUSTION HETEROGENEITY IN INTERIOR BALLISTICS OF MORTAR USING POPULATION BALANCE EQUATION

Matthias Pautard^{1,2}, Christian Chauveau², Fabien Halter², and Christophe Coulouarn¹

¹Thales LAS France, Route d'Ardon, La Ferté-Saint-Aubin 45240, France

²CNRS ICARE, Avenue de la Recherche Scientifique, Orléans Cedex 2 45071, France

Abstract: *The ever-rolling progress of weapon systems has proven to demand an increase in precision in the models to be able to achieve further improvements. In the field of interior ballistics, one of the elements that remains excluded from most models is the combustion heterogeneity due to nonequilibrium of pressure. This paper presents a zero-dimensional model of a mortar. It includes two chambers: the combustion chamber and the cartridge with combustion heterogeneity occurring between these two chambers. The model adapted to this kind of problem is the population balance equation (PBE). A successful attempt to solve the PBE numerically in this case, using the class method, is presented in this work to theoretically address the quantification of the impact of combustion heterogeneities too often ignored.*

KEY WORDS: *Mortar ammunition, interior ballistics, PBE, combustion heterogeneity*

1 Introduction

Research in the field of interior ballistics is driven by the demand for new ammunition with increasing range. The need for more complex propulsion systems has arisen as a consequence, along with faithful models to dimension those through optimization [1], since it is not possible to make an optimization on the exit or muzzle velocity of the projectile if the results of this function are not sufficiently precise with respect to experimental assessment. Also, the improvement of the interior ballistics models could allow the elaboration of more precise firing tables.

To the best of our knowledge, studies on the local combustion heterogeneity of gunpowder have not been reported yet in the interior ballistics field. This is, however, in spite of other areas of physics, where similar behaviors, following Boltzmann equations, have been characterized for decades, such as the study of particles in a reactive flow or process engineering [2]. In this case, the distribution transport equation is called the population balance equation (PBE). It is mainly used to describe crystal growth in a process reactor. An analogy can be drawn between these phenomena and the reaction undergone by gunpowder in a heterogeneous chamber. This corresponds to the work of Aldis and Gidaspow [3] regarding an initial polydispersed solid in a 1D interior ballistic problem.

The present article focuses on a simplification of Aldis and Gidaspow's PBE applied to the mortar. Mostly composed of two chambers, this sort of ammunition affords a good example of pressure heterogeneity. Few details are given here because it is already covered [4, 5, 6, 7]. Pressure heterogeneity [8] and ignition [9] have already been studied in the case of 120 mm caliber; however, the local gunpowder heterogeneity due to its own burning history has not been taken into account.

The objective of this study will therefore be to propose a new efficient method for modeling combustion heterogeneities and apply it to the case of mortar, as mortar is well known for its pressure heterogeneities. Ultimately, we aim to be able to compare theoretically its impact with that of the modeling of the initial distribution of the grain size which might be enough to predict the muzzle velocity of the projectile. This makes it possible to discuss theoretically on the relevance of the hypothesis of homogeneous combustion which is often applied implicitly.

2 Mortar model

2.1 Zero-Dimension with Two Chambers Interior Ballistics Model

Because most of the description was made in our previous work [5], only major points are summarized here. Figure 1 highlights the important elements of the model useful to the specific study of this article.

This model relies on the consideration of two homogeneous chambers as the propulsion system of the mortar is mainly composed of the cartridge and the barrel chamber. The gunpowder can pass from one to the other due to flow and drag. Ergun's law [10] has been modified to include the inertia of a grain.

All the calculus is based on the Noble-Abel equation of state. It follows the equation of energy conservation with a modification of the flow law originally proposed by Anderson [6].

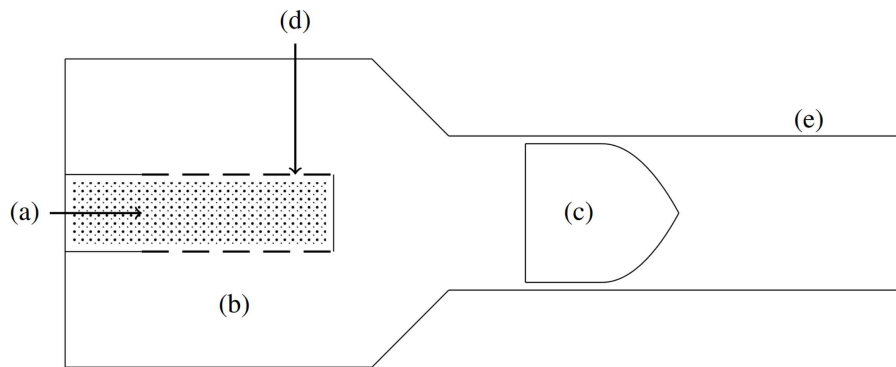

Figure 1: Diagram of the configuration chosen to model the mortar: (a) the cartridge chamber initially containing the gunpowder, (b) main chamber initially empty, (c) projectile, (d) vent hole, (e) barrel.

Combustion heterogeneity arises from the difference of burning rate induced by the pressure imbalance and erosive burning [11] which takes place in the cartridge. To ensure the mass conservation, the mass and the number of grains of gunpowder are used as variables instead of the burned thickness. From there, the mean volume of a grain is calculated from which the burning surface area can be computed, and thus amounts to a mass of a grain average.

2.2 Polydispersed gunpowder

Solving all the PBE into one equation is computationally expensive. The main challenge of this kind of probability transport equation is to reach its numerical solution. To eliminate this problem in our previous work, polydispersed gunpowder was derived in a different way than Aldis and Gidaspow [3] did. Therefore, the computational cost remains slightly higher.

The objective is to create a function that returns the surface of a grain as a function of its volume while fixing the number of grains at its initial value. This comes down to considering a fictitious equivalent grain. This method is similar to what has been implemented by Semenov and Matsevich [12] for the combustion of aluminum particles.

3 Population balance equation

3.1 PBE

Aldis and Gidaspow [3] gives the following equation for the PBE applied to the mass conservation

$$\frac{\partial}{\partial t}(\epsilon_i \rho_i) + \vec{\nabla} \cdot (\epsilon_i \rho_i \vec{V}_i) + \frac{(\epsilon_i \rho_i \frac{dR}{dt})|_{R_i}^{R_i + \Delta R}}{\Delta R} = -\dot{m}_i \quad (1)$$

The subscript i refers to the i th cell. A cell contains the burnt grains whose characteristic size R is between R_i and $R_i + \Delta R$. ϵ_i is the volume fraction, ρ_i the density, \vec{V}_i the velocity of solid, and \dot{m}_i the reaction mass flow rate due to its combustion. The intervals $[R_i; R_i + \Delta R[$ then defines the mesh cells in the grain size dimension.

The interval consideration on size is used for the implementation of a numerical method called multiclass method [13].

With our variables, this equation can be rewritten as :

$$\frac{\partial}{\partial t}(\epsilon_i / v_i^m) + \vec{\nabla} \cdot (\epsilon_i / v_i^m \vec{V}_i) + \frac{(\epsilon_i / v_i^m \frac{dv_i^m}{dt})|_{v_i}^{v_i + \Delta v}}{\Delta v} = 0 \quad (2)$$

$$\frac{\partial}{\partial t}(\epsilon_i \rho_i) + \vec{\nabla} \cdot (\epsilon_i \rho_i \vec{V}_i) + \frac{(\epsilon_i \rho_i \frac{dv_i^m}{dt})|_{v_i}^{v_i + \Delta v}}{\Delta v} = -S(v_i^m) r_b \epsilon_i \rho_i / v_i^m \quad (3)$$

Equation (2) corresponds to the conservation of the number of grains and Eq. (3) to the mass. v_i^m is the mean volume of a grain in the class i

$$v_i^m = \epsilon_i / N_i dV,$$

where dV is a local volume element and N_i the number of grains in the class i .

However, the population balance will not be computed in the same way; the reason is explained in the following section.

3.2 Numerical method

The main problem of the PBE is the link between the numerical method and the kind of problem being studied. A lot of work has been devoted to solving distribution transport equations (there are different equations in different fields, for example with or without collisions, self-consistency, etc.), such as the Vlasov equation [14]. To determine the best way to solve the PBE in interior ballistics, one must observe the necessity to manage Dirac distributions. The presence of numerical diffusion would create unrealistic behaviors.

The class method [15] works when the size distribution is wider than what the numerical diffusion generates. For a Dirac distribution, a discrete transfer method seems to be a good way to avoid numerical diffusion. To implement it in the case of the mortar, the numerical method used to solve the interior ballistics model has to be described first. The numerical constraints change during the calculation. First the burnt gases flow from the cartridge to the main chamber causing erosive burning. This phase requires a smaller time step than during the second phase where the two chambers are in a quasi-equilibrium. An efficient method including automatic rescale time step is the Runge–Kutta–Merson method [16]. However, as a Runge–Kutta algorithm, it is not suitable for handling events such as grain class change. A solution to this incompatibility will be presented subsequently.

Keeping in mind the goal of the lowest numerical computation time, the calculation of $S(v_i^m)$ must be detailed. An efficient way to evaluate this function is done through a table, looking for the interval $[v_i; v_{i+1}]$ containing v_i^m using a dichotomy. The target value can then be estimated by a linear approximation

$$S(v_i^m) = \frac{S(v_{i+1}) - S(v_i)}{v_{i+1} - v_i} (v_i^m - v_i) + S(v_i) \quad (4)$$

In our case, the dichotomy is not necessary since the current interval is already known. If $v_i^m(t + dt)$ becomes smaller than v_{i+1} , then the mass and the number of grains are transferred to the next class. However, if this event happens during the calculation of a time step, proceeding to the transfer will prevent the convergence of the Runge–Kutta–Merson method. To properly assess the surface of a grain while waiting for the end of a time step to perform the transfer, a simple check is satisfactory, which can be described as follows:

$$S(v_i^m) = \begin{cases} \frac{S(v_{i+1}) - S(v_i)}{v_{i+1} - v_i} (v_i^m - v_i) + S(v_i) & , v_i^m \geq v_{i+1} \\ \frac{S(v_{i+2}) - S(v_{i+1})}{v_{i+2} - v_{i+1}} (v_i^m - v_{i+1}) + S(v_{i+1}) & , v_i^m < v_{i+1} \end{cases} \quad (5)$$

As a consequence, a major computational cost problem arises, as the PBE adds as many differential equations as the number of classes grows. In the particular case of interior ballistics, it is reasonable to assume that the distribution will remain narrow. Therefore, most of the PBE equations will be applied to zero values. It is enough to ignore these equations by activating or deactivating the class according to the presence or not of a grain in the current class. If the distribution is close to a Dirac, the computation time will not differ a lot from that homogeneous assumption.

4 Results and Discussion

4.1 140 mm mortar characteristics

In order to evaluate the impact of heterogeneities, the 140 mm mortar proposed in our previous work [5] is used. Other cases with thinner flakes will also be tested. The difference between initial grains of polydispersed sizes and identical grains is studied. Most of the relevant data are gathered in Tables 1 and 2.

Term	Data
Radius of barrel	70 mm
Displacement length	1 m
Projectile mass	20 kg
Cartridge volume	175,7 cm ³
Main chamber volume	5222 cm ³
Exchange area	39,1 cm ²
Rupture pressure	10 MPa

Table 1: Projectile launch system data

Term	Data
Shape	Flake
Mass	94 g
Web thickness	0,22; 0,26; 0,3 mm
Density	1600 kg.m ⁻³
Heat of reaction	4,8 MJ.kg ⁻¹
Specific heat ratio	1,205
Vieille Law with P in Pa	$1.10^{-8}P^{0,9} + 1.10^{-3} m.s^{-1}$

Table 2: Characteristics of the gunpowder

4.2 Results

Figure 2 shows the pressure evolution in the mortar chamber for different grain thicknesses. With all of them being initially identical, a consequence is the presence of a stair-step shape visible on Fig. 3. Due to the numerical approach of locally packing the burnt thickness and flake shape, the total surface decreases discontinuously while the gunpowder is about to vanish.

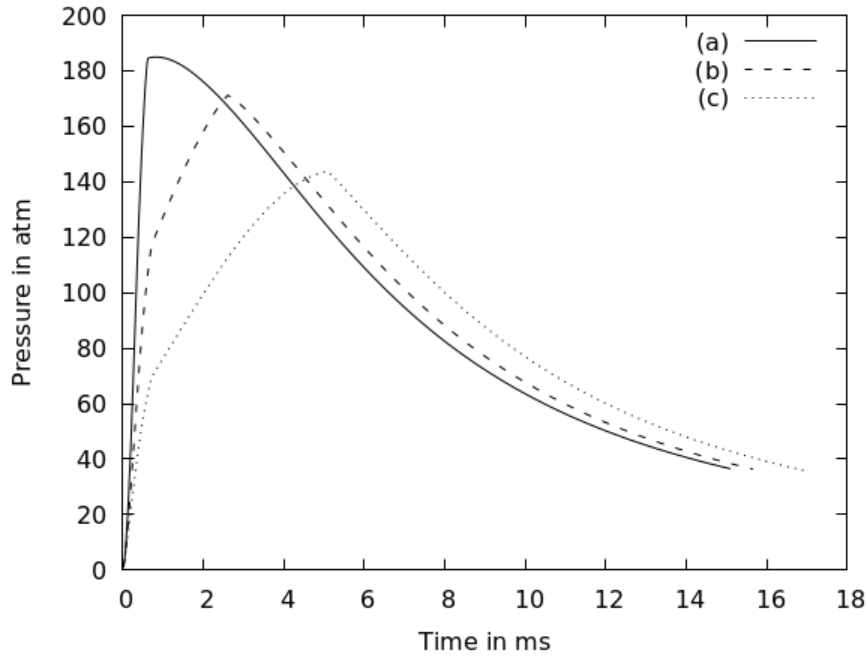

Figure 2: Pressure evolution over time for different web thicknesses, (a) 0, 22mm, (b) 0, 26mm, (c) 0, 3mm.

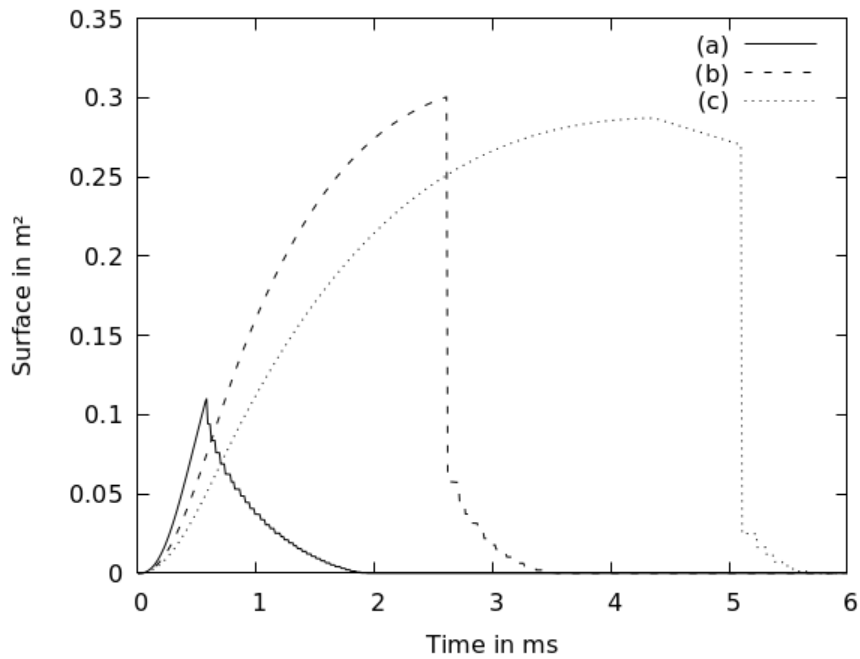

Figure 3: Total surface of the gunpowder in the main chamber over time for different web thicknesses, (a) 0, 22mm, (b) 0, 26mm, (c) 0, 3mm.

Figure 4 illustrates the impact of a polydispersed gunpowder considering a standard deviation of the thickness of $\sigma = 2.10^{-6} m$ and a web-thickness of 0, 26mm. This does not alter significantly the phenomena studied here while making the surface of a grain continuous, so the stair-step shape no longer appears. The modification of the gunpowder is plotted on Fig. 5.

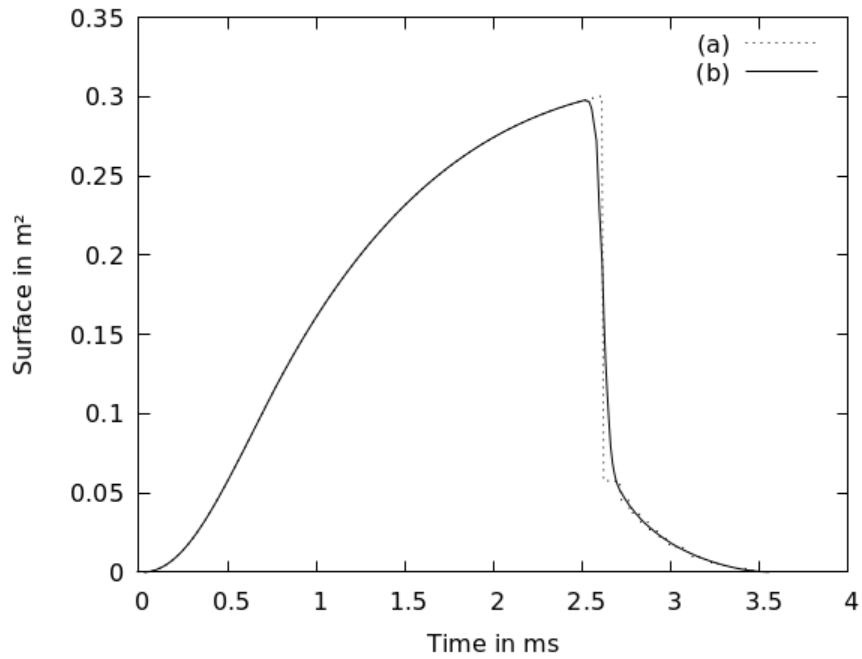

Figure 4: Total burning surface area in the main chamber over time (a) without initial polydispersed size or (b) with initial polydispersed size.

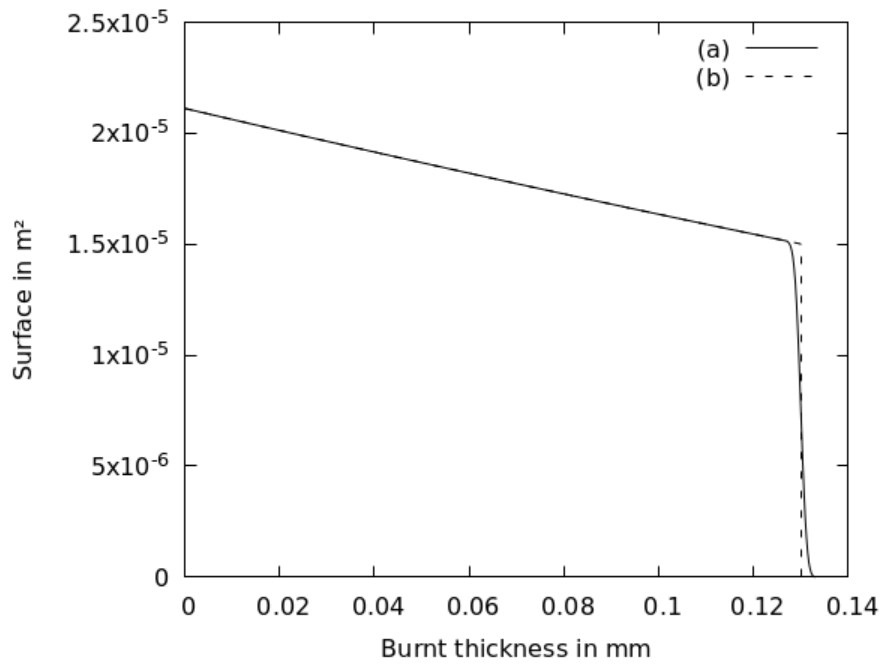

Figure 5: Burning surface area of one flake with (a) or without (b) polydispersed size.

To sum it all up, Fig. 6 highlights the consequences of combustion heterogeneity in the mortar.

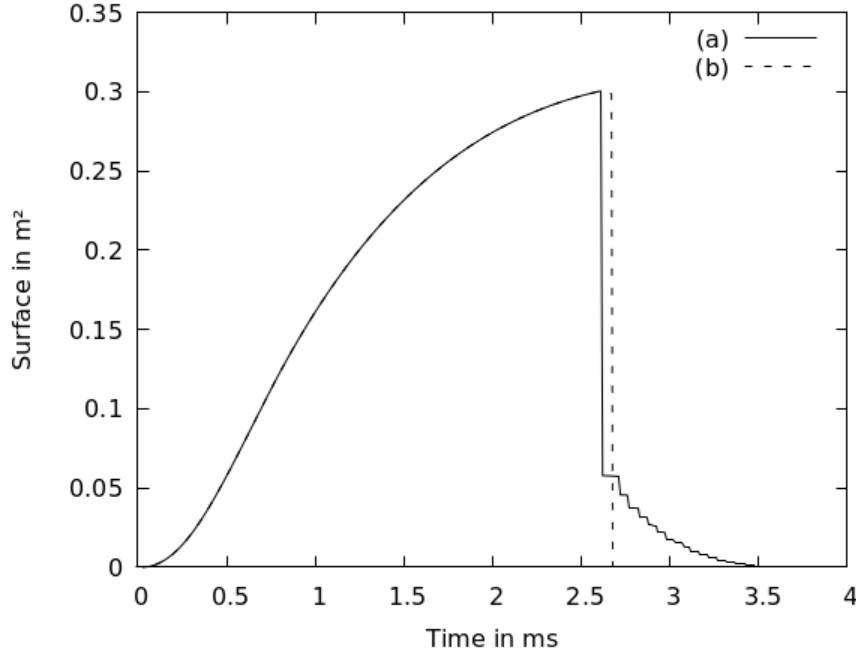

Figure 6: Comparison of the total burning surface area in the main chamber over time with (a) the PBE or (b) the homogeneous assumption.

4.3 Mesh convergence

All the previous calculations were achieved with 128 cells in volume particle dimension.

Table 3 shows the low dependency on the mesh size. Regarding the computation time, for this type of gunpowder, a mesh of a size of 128 cells is sufficient.

Mesh size	Velocity	Compute time
128	104,579 $m.s^{-1}$	0,703 s
256	104,582 $m.s^{-1}$	1,484 s
516	104,582 $m.s^{-1}$	3,688 s
1024	104,581 $m.s^{-1}$	15,66 s
Homogeneous	104,588 $m.s^{-1}$	0,547 s

Table 3: Comparison for different mesh size

4.4 Discussion

The main source of combustion heterogeneity in the mortar is the difference of burning rate between the cartridge and the main chamber. This is due to the pressure difference and the erosive burning. This results in the behavior observable on Fig. 3. The gunpowder area increases due to its transport from the cartridge to the chamber. Since the distribution remains narrow and the form factor barely varies, no difference is noticeable in Fig. 6.

However, the gradual disappearance of the grain changes from a brutal transition to a progressive end, akin to the initial polydisperse size. The nondiffusive numerical method ensures the absence of spreading which would modify the disappearance of the gunpowder and so the evolution of the pressure. In contrast to the polydisperse distribution, heterogeneities seem to generate a Poisson distribution instead of a Gaussian one in the mortar case.

Finally, the results considering a realistic initial polydisperse size are shown Fig. 7. No major differences can be observed, the spreading due to the polydisperse size affecting principally the surface evolution rather than the combustion heterogeneities.

Based on these observations, especially the result displayed in Fig. 7, and those presented in Table 3, the effect of initial polydispersed size is much more impactful than that of the combustion heterogeneity on the pressure in the main chamber and therefore the muzzle velocity of the projectile. It therefore seems that the Aldis method [3] of using PBE for combustion heterogeneities and initial grain size distribution is not relevant for mortar ammunition. Since the combustion heterogeneities have a negligible impact and there is a much simpler method to only model the initial polydispersed size [5], it is more suitable in the present case not to use the straight PBE.

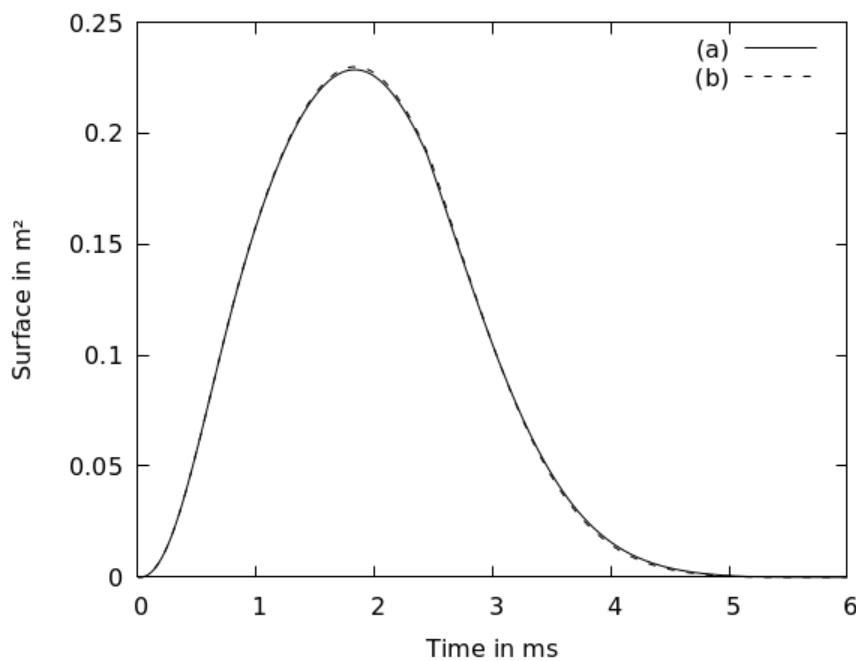

Figure 7: Comparison of the total burning surface area of the gunpowder in the main chamber over time with (a) the PBE or (b) homogeneous assumption with a polydispersed size of $\sigma = 5.10^{-5} m$.

5 Conclusion

In this paper, a new numerical method dedicated to solving PBE with no diffusion has been introduced. It allows accounting for narrow distributions due to heterogeneities. This solution is well adapted for interior ballistics problems. The heterogeneities not being known in advance, diffusion would spread the distribution even with a homogeneous chamber, while the computational cost remains close to that of the homogeneous method.

Also, the decoupling of the initial polydisperse size and the distribution due to heterogeneities is efficient.

The mortar configuration described here does not require the modeling of combustion heterogeneities in order to roughly predict the output velocity. To the first-order prediction of the muzzle velocity for a mortar ammunition, it is not necessary to model the combustion heterogeneities but only the initial polydispersed size. However, it could be very interesting to test this method in 2D or 3D to challenge this guess. Moreover, it would be very interesting to compare these conclusions with experimental measurements and this will be addressed in future work.

It is very likely that not taking into account the PBE, for heterogeneities and polydisperse size, would induce larger errors in small calibers than in a mortar.

Acknowledgments

The research was supported by Thales LAS France.

References

- [1] Kejing Li **and** Xiaobing Zhang. “Using NSGA-II and TOPSIS Methods for Interior Ballistic Optimization Based on One-Dimensional Two-Phase Flow Model”. *in**Propellants, Explosives, Pyrotechnics*: 37.4 (2012), **pages** 468–475.
 - [2] S. Rigopoulos. “Population balance modelling of polydispersed particles in reactive flows”. *in**Progress in Energy and Combustion Science*: 36.4 (1 **august** 2010), **pages** 412–443.
 - [3] D. F. Aldis **and** D. Gidaspow. “Combustion of a polydispersed solid using a particle population balance”. *in**Powder Technology*: 57.4 (1 **april** 1989), **pages** 281–294.
 - [4] Jan Krčmar, Claude Steinbach **and** Khalid Dahhani. “Interior Ballistics Simulation of the Two Chambers GLMAV Launcher”. *in**Propellants, Explosives, Pyrotechnics*: 39.5 (2014), **pages** 768–773.
 - [5] Matthias Pautard **and others**. “Modelling of the internal ballistics of mortar including polydisperse gunpowder size”. *in*51st International Annual Conference of the Fraunhofer ICT: 28 **june** 2022.
 - [6] Ronald D. Anderson. “IBHVG2: Mortar Simulation With Interior Propellant Canister”. *in**Army research lab aberdeen proving ground md*: (2006).
 - [7] Peter J. Ferrara **and** Jeffrey D. Moore. “Method of characteristics simulation of interior ballistic processes of M1020 ignition cartridge in A 120-mm mortar system”. *in**International Journal of Energetic Materials and Chemical Propulsion*: 6.5 (2007).
 - [8] Ragini Acharya. “Effect of different flash-tube vent-hole patterns on interior ballistic processes of ignition cartridge of 120-mm mortar system”. *in**International Journal of Energetic Materials and Chemical Propulsion*: 7.5 (2008).
 - [9] Michael Nusca. “Multidimensional interior ballistics modeling of igniter performance for solid propellant gun charges”. *in**International Journal of Energetic Materials and Chemical Propulsion*: 13.3 (2014).
 - [10] Sabri Ergun. “Fluid flow through packed columns”. *in**Chem. Eng. Prog.*: 48 (1952), **pages** 89–94.
-

-
- [11] H. S. Mukunda **and** P. J. Paul. “Universal behaviour in erosive burning of solid propellants”. *in* *Combustion and Flame*: 109.1 (**april** 1997), **pages** 224–236.
- [12] I. A. Semenov **and** B. V. Matsevich. “Dynamic Features of Combustion of Polydisperse Aluminum Powders in a Gas”. *in* *Combustion, Explosion and Shock Waves*: 41.4 (1 **july** 2005), **pages** 430–434.
- [13] Q. Hu, S. Rohani **and** A. Jutan. “New numerical method for solving the dynamic population balance equations”. *in* *AIChE Journal*: 51.11 (2005), **pages** 3000–3006.
- [14] Francis Filbet. “Contribution à l’analyse et la simulation numérique de l’équation de Vlasov”. phdthesis. Université Henri Poincaré - Nancy 1, 2 **july** 2001.
- [15] Stelios Rigopoulos. “PDF method for population balance in turbulent reactive flow”. *in* *Chemical Engineering Science*: 62.23 (1 **december** 2007), **pages** 6865–6878.
- [16] George H. Burgin. “Comment on the Runge-Kutta-Merson Algorithm”. *in* *SIMULATION*: 15.2 (1 **august** 1970), **pages** 89–91.
-