



**HAL**  
open science

# New ZVS Modulation Patterns for the Dual Active Bridge Converter

Kubilay Sahin, Sébastien Mariéthoz, Jean-Luc Schanen, Yann Cuenin

► **To cite this version:**

Kubilay Sahin, Sébastien Mariéthoz, Jean-Luc Schanen, Yann Cuenin. New ZVS Modulation Patterns for the Dual Active Bridge Converter. ECCE Europe 2024, Sep 2024, Darmstad, Germany. hal-04702333

**HAL Id: hal-04702333**

**<https://cnrs.hal.science/hal-04702333v1>**

Submitted on 19 Sep 2024

**HAL** is a multi-disciplinary open access archive for the deposit and dissemination of scientific research documents, whether they are published or not. The documents may come from teaching and research institutions in France or abroad, or from public or private research centers.

L'archive ouverte pluridisciplinaire **HAL**, est destinée au dépôt et à la diffusion de documents scientifiques de niveau recherche, publiés ou non, émanant des établissements d'enseignement et de recherche français ou étrangers, des laboratoires publics ou privés.

# New ZVS Modulation Patterns for the Dual Active Bridge Converter

Kubilay Sahin

*Power Electronics Laboratory*  
Bern University of Applied Sciences  
Biel/Bienne, Switzerland  
kubilay.sahin@bfh.ch

Sébastien Mariéthoz

*Power Electronics Laboratory*  
Bern University of Applied Sciences  
Biel/Bienne, Switzerland  
sebastien.mariethoz@bfh.ch

Jean-Luc Schanen

*G2Elab*  
Grenoble Alpes University  
Grenoble, France  
jean-luc.schanen@g2elab.grenoble-inp.fr

Yann Cuenin

Studer Innotec SA  
Sion, Switzerland  
yann.cuenin@studer-innotec.com

**Abstract**—The Dual Active Bridge (DAB) converter is a popular topology which is used as an isolation stage in various applications. A new method is presented which leads to novel modulation patterns that allow full coverage of the operating area with ZVS without the need of adjusting the switching frequency or adapting the transformer. The feasibility of the new modulation patterns was verified experimentally.

**Index Terms**—DAB, ZVS, Modulation, Pattern

## I. INTRODUCTION

It is advantageous to switch at zero voltage to reduce switching losses and thus the total losses of the converter. However, this means that the modulation pattern must function in such a way that the requirements for ZVS are met. Ideally, a modulation pattern exists which guarantees ZVS at each switching point in the entire working area without increasing conduction losses, so that the overall efficiency is increased. The DAB and the Single Phase Shift (SPS) modulation which leads to a limited ZVS range was first presented in [1]. The SPS modulation is the simplest way to control the power transfer of the DAB, since the primary and secondary voltage duty cycles are fixed at 50 % and only the phase shift between them is changed. In order to overcome the limited ZVS range, the Variable Frequency Phase Shift Modulation (VFM) was proposed which increases the ZVS range by changing the switching frequency [2]. The Dual Phase Shift (DPS) modulation is an extension of the SPS modulation, where the pulse duration of the primary and secondary side voltage is no longer fixed at 50 % but changed to the same extent. Furthermore the phase shift

between both voltages is changed as is the case with the SPS. Thus two degrees of freedom are available. In [3] they claim that the DPS modulation decreases the current stress, increases the working area where ZVS is possible as well as reduces the reactive power. A further extension is the Triple Phase Shift (TPS) modulation, which allows three degrees of freedom, as the pulse duration of the primary voltage and the secondary voltage are not the same anymore and the phase shift between the two voltages is changed. The SPS and DPS modulations are special cases of the TPS modulation, because, in contrast to the TPS, not all three degrees of freedom are used. With help of optimization algorithms parameters are found for the three degrees of freedom that minimize the total losses [4], [5] and [6]. In [4], the magnetization inductance is taken into account in order to obtain ZVS in the entire operating area, which leads to additional challenges in the design of the transformer. In [5], ZVS has been achieved for low and high power transfer, but not for medium ones. In [6], ZVS has been achieved in the entire operating area by changing the switching frequency. Therefore, no modulation pattern is known so far that allows ZVS in the entire operating area without changing the switching frequency or adapting the transformer for the DAB. The main contribution of this paper is a new method which leads to novel modulation pattern that allow full coverage of the operating area with ZVS without the need of adjusting the switching frequency or adapting the transformer.

## II. LIMITED SET OF ZVS MODULATION PATTERN

According to the state of the art, the currently known modulation strategies do not offer complete coverage of the operating range with ZVS, unless the switching frequency or the magnetization inductance of the transformer are adjusted. From this knowledge, the question can be asked whether it is also possible to achieve ZVS in the entire operating area without having to change the switching frequency or the magnetization inductance of the transformer? Why do one want to find such modulation patterns? Well, it could be advantageous to further reduce the overall losses of the converter and would also prevent the need to design special transformers. So if such modulation patterns exist, why haven't they been found yet? To answer this question, it is necessary to investigate how the currently known modulation patterns work. The electric circuit diagram of the DAB is visible in Figure 1a. The voltage  $U_{A_{dc}}$  is applied on the primary side and the voltage  $U_{B_{dc}}$  on the secondary side. By controlling the semiconductors on the primary and secondary side, the voltage  $u_L$  applied across the leakage inductance  $L$  is changed, thereby shaping the current  $i_L$ . The unique shaping of the current leads to the following consequences:

- The transferred power
- The RMS value of the current  $i_L$ , which leads to the conduction losses
- Through which semiconductors the current flows during the switching process, which defines the capability for ZVS at a specific operating point as well as the switching losses

Therefore, it is essential which voltages are applied over the leakage inductance of the transformer. It is visible that in the case of SPS, only  $T_1$  is changed. The pulse duration of  $u_A$  and  $u_B$  are both fixed at 50%, which means that there is only one degree of freedom. In the case of DPS,  $T_1$  and  $T_2$  can be changed, whereby  $T_2$  defines the pulse duration of  $u_A$  and  $u_B$ . There are therefore two degrees of freedom. In the case of TPS,  $T_1$ ,  $T_2$  and  $T_3$  can be changed, resulting in the largest degree of freedom of three. As SPS and DPS are a special case of TPS, it is sufficient to consider only TPS. In the state of the art, the three degrees of freedom are changed with help of optimization algorithms in order to find novel modulation pattern that minimizes the total losses [4], [5] and [6]. This means that only solutions that result from the combination of these three degrees of freedom can be found. But what if more degrees of freedom exist? That would mean that the set of solutions must actually be larger than has been discovered so far. This in turn leads

to the conclusion that if new modulation patterns want to be found, new degrees of freedom would first have to be found. Well, what other degrees of freedom could there be? There is one that has obviously been overlooked so far, and that is the number of applied voltage pulses on the primary and the secondary side of the transformer per half-wave. Although the pulse duration of  $u_A$ ,  $u_B$  and the phase shift between the two voltages are changed, the number of pulses per half-wave is always limited to a maximum of one. This results in the fact that not all possible solutions of modulation patterns for the DAB are known so far and there may exist other modulation pattern that lead to a complete coverage of the operating area with ZVS without changing the switching frequency or adjusting the leakage inductance of the transformer.

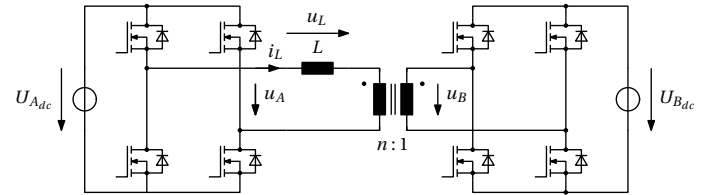

(a) Electric circuit diagram of the DAB

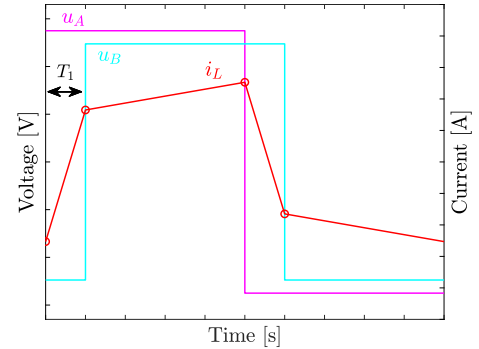

(b) SPS modulation waveforms

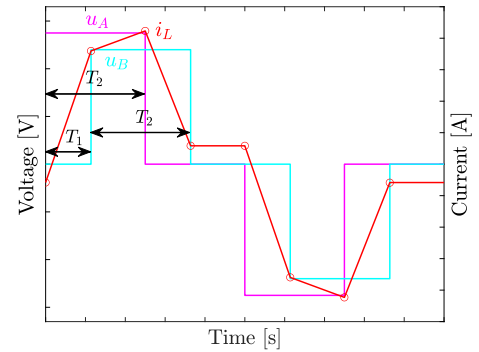

(c) DPS modulation waveforms

Fig. 1: State of the art DAB modulation pattern

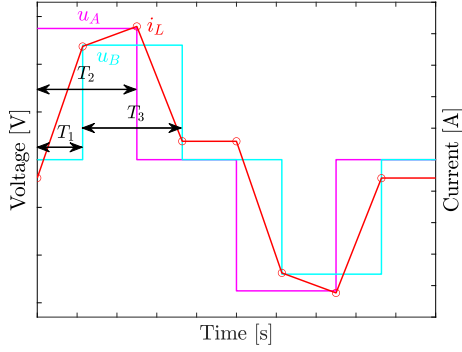

(d) TPS modulation waveforms

Fig. 1: State of the art DAB modulation pattern

### III. ENLARGEMENT OF THE SET OF ZVS MODULATION PATTERN

#### A. Possible transformer leakage inductance voltages

In order to overcome the usage of maximal one voltage pulse for  $u_A$  and  $u_B$  per half-wave which leads to the limited set of ZVS modulation pattern for the DAB, the possible voltages which can be applied across the leakage inductance of the transformer are firstly determined. The set of voltages applicable for  $u_A$  on the primary side are defined as follows:

$$u_A \in \{U_{A_{dc}}, 0, -U_{A_{dc}}\} \quad (1)$$

The set of voltages applicable for  $u_B$  on the secondary side are defined as follows:

$$u_B \in \{U_{B_{dc}}, 0, -U_{B_{dc}}\} \quad (2)$$

This leads to the following 9 voltages which can be applied across  $L$ .

$$u_L \in \{U_{A_{dc}} - n \cdot U_{B_{dc}}, U_{A_{dc}}, U_{A_{dc}} + n \cdot U_{B_{dc}}, -n \cdot U_{B_{dc}}, 0, n \cdot U_{B_{dc}}, -U_{A_{dc}} - n \cdot U_{B_{dc}}, -U_{A_{dc}}, -U_{A_{dc}} + n \cdot U_{B_{dc}}\} \quad (3)$$

Of course, the application of these voltages does not make sense in every case. A distinction must be made between the direction in which the active power is transmitted as well as whether the half-wave of the alternating current flowing through the leakage inductance of the transformer is positive or negative. In Table I 4 cases are summarized which are differentiated according to direction of power flow and the sign of the half-wave.

#### B. Condition for ideal ZVS

In order to understand how the defined voltages should be applied over the leakage inductance of the transformer for ZVS to take place, the ZVS transition must be investigated. For ideal ZVS to be guaranteed in a switching cell, the condition must be met, that the current in the semiconductor to be switched off flows from drain to source during the switching process. This results in the  $C_{OSS}$  of the semiconductor to be switched on discharging completely in the ideal case, so that switching takes place at zero voltage. The ideal ZVS is illustrated in Figure 2.

#### C. Derivation of the DAB ZVS transition diagram and 6 new modulation patterns

By combining all possible voltages that can be applied across the leakage inductance of the transformer from subsection III-A and the condition for ideal ZVS from subsection III-B, the diagram in Figure 3 which visualizes modulation paths that guarantee ZVS on primary and secondary side of the DAB for every voltage transition for the positive half-wave can be derived. For the negative half-wave, the diagram was not shown, since the principle is the same as for the positive half-wave. The different parts of the diagram are described in Table II. With help of this diagram, 6 new modulation patterns are derived for the DAB which always switch at zero voltage. The new modulation patterns are illustrated in Figure 4. As example, the path for the DAB ZVS Triangular 4 modulation was drawn into the diagram in red. The other new modulation patterns were found by repeating the same procedure using other paths. It is interesting to see, that also two modulation patterns, namely the DAB ZVS Triangular 5 and the DAB ZVS Trapezoidal 1 which are both solutions of the TPS modulation are also found using the DAB ZVS transition diagram. These patterns were also found by optimization algorithms [4], [5] and [6]. By combining the new modulation patterns from Figure 4, the entire operating range can be covered with ZVS without having to change the switching frequency or adapt the transformer, as is the case with conventional modulation pattern [4], [5] and [6]. Further details on the newly found modulation patterns, in particular on the operating ranges covered by each individual modulation pattern, how the combination of the modulation patterns works to cover the entire operating range, what converter losses are caused and what common mode current is caused, will follow in further publications. It is also worth noting that the 6 new modulation patterns from Figure 4 were graphically determined with the aim of traversing the shortest path

Case	Power direction	Half-wave of $i_L$	Active power	No power	Reactive power
1	A to B	positive	$U_{A_{dc}} - n \cdot U_{B_{dc}}, U_{A_{dc}}, -n \cdot U_{B_{dc}}$	0	$U_{A_{dc}} + n \cdot U_{B_{dc}}, -U_{A_{dc}} + n \cdot U_{B_{dc}}$
2	A to B	negative	$-U_{A_{dc}} + n \cdot U_{B_{dc}}, -U_{A_{dc}}, n \cdot U_{B_{dc}}$	0	$U_{A_{dc}} + n \cdot U_{B_{dc}}, -U_{A_{dc}} + n \cdot U_{B_{dc}}$
3	B to A	positive	$-U_{A_{dc}} + n \cdot U_{B_{dc}}, -U_{A_{dc}}, n \cdot U_{B_{dc}}$	0	$U_{A_{dc}} + n \cdot U_{B_{dc}}, -U_{A_{dc}} + n \cdot U_{B_{dc}}$
4	B to A	negative	$U_{A_{dc}} - n \cdot U_{B_{dc}}, U_{A_{dc}}, -n \cdot U_{B_{dc}}$	0	$U_{A_{dc}} + n \cdot U_{B_{dc}}, -U_{A_{dc}} + n \cdot U_{B_{dc}}$

TABLE I: Possible transformer leakage inductance voltages

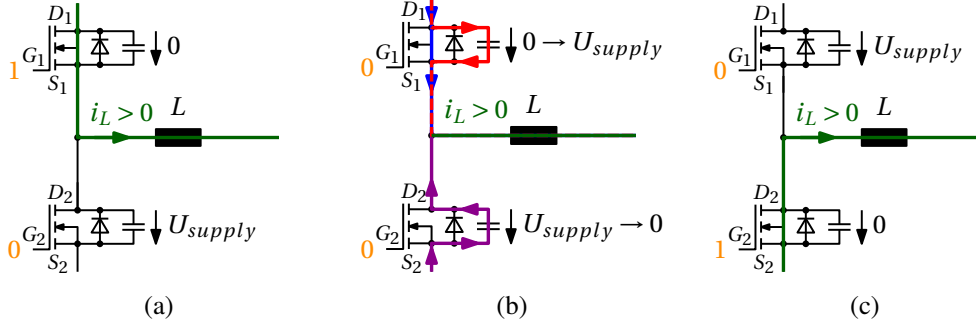

Fig. 2: Ideal ZVS transition with (a) upper (b) none and (c) lower switch closed

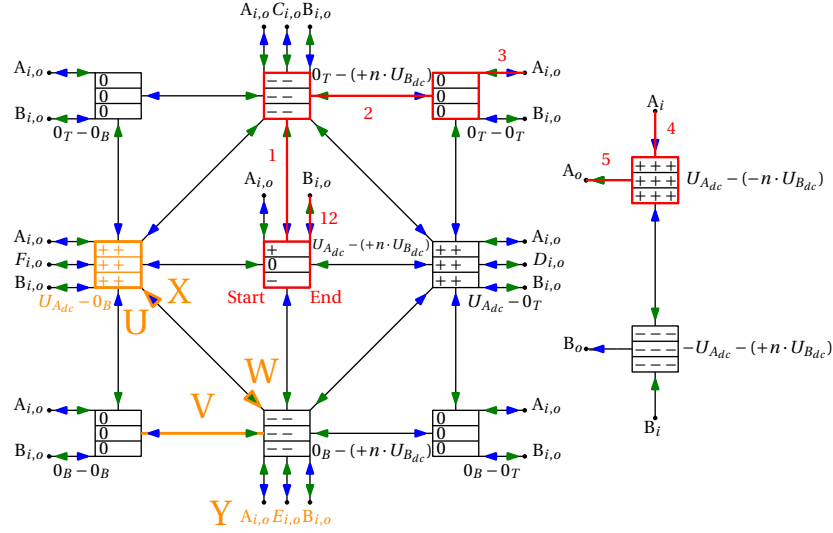

Fig. 3: DAB ZVS transition diagram

Part	Description
U	The indicated voltage is applied as $u_L$ . The signs +++ indicate big, ++ medium, + small positive and --- big, -- medium, - small negative and 0 zero transformer leakage inductance current slope. The top row shows the current slope for $U_{A_{dc}} > U_{B_{dc}}$ , the middle row for $U_{A_{dc}} = U_{B_{dc}}$ , and the bottom row for $U_{A_{dc}} < U_{B_{dc}}$ .
V	Transition paths between voltage states.
W	Positive flow direction of transformer leakage inductance current.
X	Negative flow direction of transformer leakage inductance current.
Y	Letters $A_{x,y}, B_{x,y}, C_{x,y}, D_{x,y}, E_{x,y}, F_{x,y}$ indicate $i$ (input) and $o$ (output) connections.

TABLE II: Description of DAB ZVS transition diagram parts

in the DAB ZVS transitions diagram Figure 3 , which should result in the smallest switching losses as well as the smallest conduction losses. It cannot be ruled out that the DAB ZVS transitions diagram could also be traversed using an optimization algorithm in order to find more or better DAB ZVS modulation schemes in terms of overall losses. What can be said with certainty, however, is that if all possible voltages in Table I that can be applied across the leakage inductance of the transformer are complete and correct, the DAB ZVS modulation diagram should provide all possible ZVS modulation patterns that exist. This was not possible with the previous state of the art optimization algorithms [4], [5] and [6], as the degree of freedom of the voltage pulses on the primary and secondary side were artificially limited to a maximum of 1, which was described in section II.

#### IV. EXPERIMENTAL RESULTS

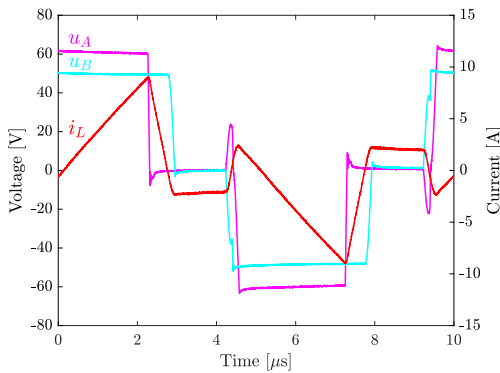

(a) DAB ZVS Triangular 4 experimental result

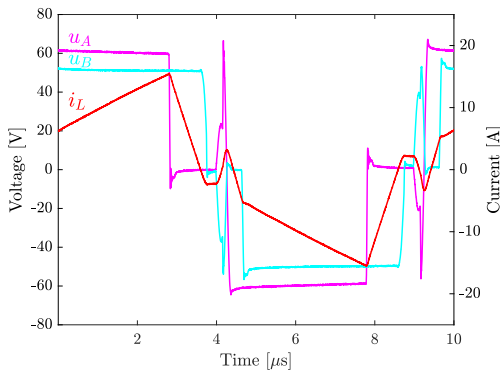

(b) DAB ZVS Trapezoidal 4 experimental result

Fig. 5: Experimental proof of the feasibility of the new DAB ZVS modulation patterns

The feasibility of two of the new modulation patterns from Figure 4 was verified experimentally Figure 5. The computation of the patterns was implemented on a microcontroller board and the patterns were generated

using an FPGA. EPC2302 eGaN FETs were used as switches in the DAB. The primary voltage  $U_{Adc}$  was set to 60 V using a voltage source and the secondary voltage  $U_{Bdc}$  was set to 48 V using an electrical load. At a switching frequency of 100 kHz and a transformer leakage inductance of 3  $\mu$ H, 144 W and 288 W of power were transmitted respectively.

#### V. CONCLUSIONS

In section II it was described that the conventional modulation patterns, namely the SPS, DPS and TPS without modifying either the switching frequency or the transformer, are not sufficient to cover the entire operating range with ZVS. The reason for this is the artificial limitation that has been created, as a maximum of one voltage pulse is used in each half-wave. To overcome this limitation, all possible voltages that can be applied across the transformer leakage inductance were defined in subsection III-A. Then in subsection III-B the condition was described how ideal ZVS occurs in a switching cell. Then, in subsection III-C, a diagram was derived which shows the transformer leakage inductance current directions needed to switch from one voltage to the other with ZVS on the primary and secondary side. With the help of this diagram, 6 new modulation patterns were found that cover the entire operating area with ZVS Figure 4 without having to modify the switching frequency or the transformer as until now. In section IV, the feasibility of the new modulation patterns was verified experimentally.

#### ACKNOWLEDGMENT

This work was supported by Innosuisse project 44273.1 IP-ENG.

#### REFERENCES

- [1] R.W. De Doncker, D.M. Divan, and M.H. Kheraluwala. "A three-phase soft-switched high power density DC/DC converter for high power applications". In: *Conference Record of the 1988 IEEE Industry Applications Society Annual Meeting*. 1988, 796–805 vol.1. DOI: 10.1109/IAS.1988.25153.
- [2] Jani Hiltunen et al. "Variable-Frequency Phase Shift Modulation of a Dual Active Bridge Converter". In: *IEEE Transactions on Power Electronics* 30.12 (2015), pp. 7138–7148. DOI: 10.1109/TPEL.2015.2390913.

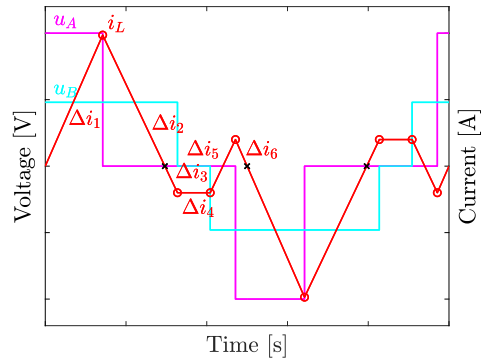

(a) DAB ZVS Triangular 5 (TPS modulation)

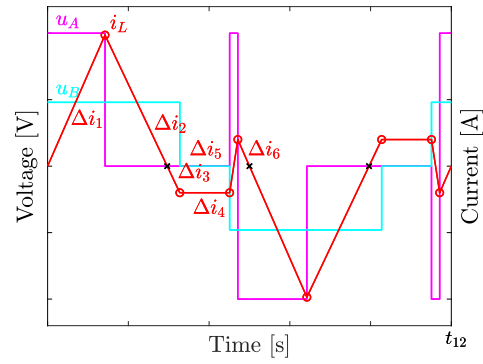

(b) DAB ZVS Triangular 4 (novel)

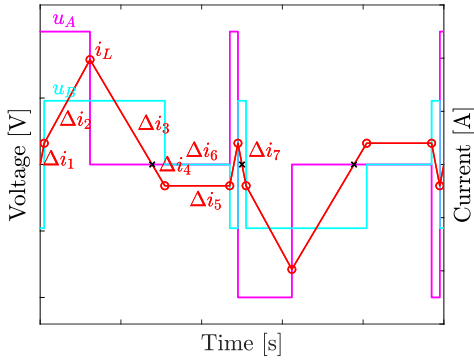

(c) DAB ZVS Triangular 3 (novel)

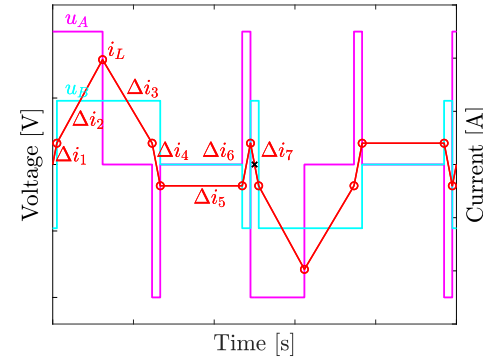

(d) DAB ZVS Triangular 2 (novel)

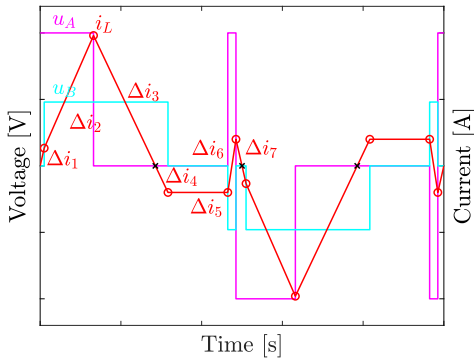

(e) DAB ZVS Trapezoidal 4 (novel)

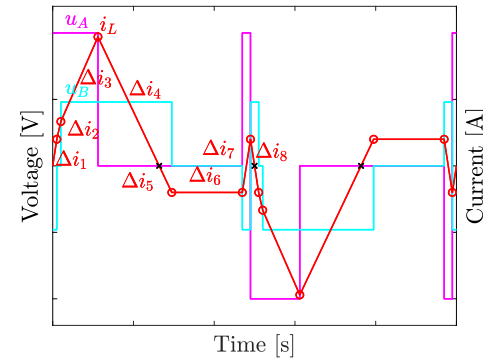

(f) DAB ZVS Trapezoidal 3 (novel)

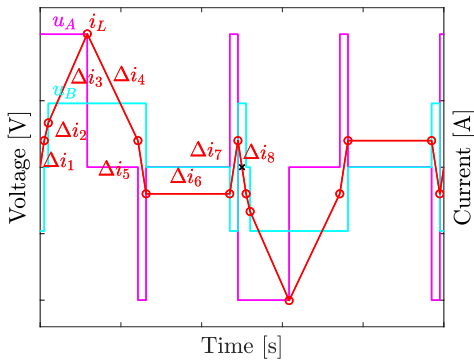

(g) DAB ZVS Trapezoidal 2 (novel)

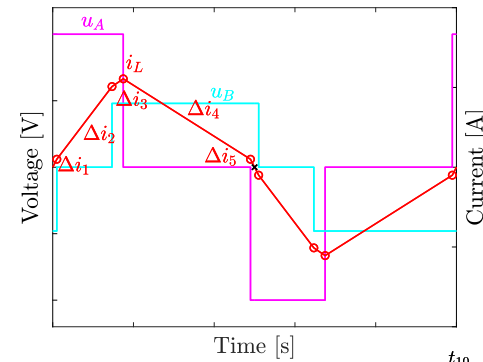

(h) DAB ZVS Trapezoidal 1 (TPS modulation)

Fig. 4: DAB ZVS modulation patterns

- [3] Nie Hou and Yun Wei Li. “Overview and Comparison of Modulation and Control Strategies for a Non-resonant Single-Phase Dual-Active-Bridge DC–DC Converter”. In: *IEEE Transactions on Power Electronics* 35.3 (2020), pp. 3148–3172. DOI: 10.1109/TPEL.2019.2927930.
- [4] Jordi Everts et al. “Switching control strategy for full ZVS soft-switching operation of a Dual Active Bridge AC/DC converter”. In: *2012 Twenty-Seventh Annual IEEE Applied Power Electronics Conference and Exposition (APEC)*. 2012, pp. 1048–1055. DOI: 10.1109/APEC.2012.6165948.
- [5] Linxiao Gong et al. “A Dynamic ZVS-Guaranteed and Seamless-Mode-Transition Modulation Scheme for the DAB Converter That Maximizes the ZVS Range and Lowers the Inductor RMS Current”. In: *IEEE Transactions on Power Electronics* 37.11 (2022), pp. 13119–13134. DOI: 10.1109/TPEL.2022.3180759.
- [6] Dingsihao Lyu et al. “ZVS-Optimized Constant and Variable Switching Frequency Modulation Schemes for Dual Active Bridge Converters”. In: *IEEE Open Journal of Power Electronics* 4 (2023), pp. 801–816. DOI: 10.1109/OJPEL.2023.3319970.