



HAL
open science

Industrial Application of an Advanced Bi-level MDO Formulation to Aircraft Engine Pylon Optimization

Anne Gazaix, F. Gallard, V. Ambert, D. Guénot, M. Hamadi, S. Grihon, P. Sarouille, T. Druot, J. Brézillon, V. Gachelin, et al.

► **To cite this version:**

Anne Gazaix, F. Gallard, V. Ambert, D. Guénot, M. Hamadi, et al.. Industrial Application of an Advanced Bi-level MDO Formulation to Aircraft Engine Pylon Optimization. AIAA 2019-3109, Jun 2019, Unknown, United States. 10.2514/6.2019-3109 . hal-04730652

HAL Id: hal-04730652

<https://cnrs.hal.science/hal-04730652v1>

Submitted on 10 Oct 2024

HAL is a multi-disciplinary open access archive for the deposit and dissemination of scientific research documents, whether they are published or not. The documents may come from teaching and research institutions in France or abroad, or from public or private research centers.

L'archive ouverte pluridisciplinaire **HAL**, est destinée au dépôt et à la diffusion de documents scientifiques de niveau recherche, publiés ou non, émanant des établissements d'enseignement et de recherche français ou étrangers, des laboratoires publics ou privés.

Industrial Application of an Advanced Bi-level MDO Formulation to an Aircraft Engine Pylon Optimization

A. Gazaix^{*}, F. Gallard[†], V. Ambert[‡], D. Guénot[§], M. Hamadi[¶], P. Sarouille^{||}, S. Grihon^{**}, T. Druot^{††}, J. Brézillon^{‡‡}, T. Lefebvre^{§§}, N. Bartoli^{¶¶}, R. Lafage^{***}, V. Gachelin^{†††}, J. Plakoo^{‡‡‡}, N. Desfachelles^{§§§}, S. Gurol^{¶¶¶}, B. Pauwels¹⁷, and C. Vanaret¹⁸

Institute of Technology IRT Saint Exupéry, Toulouse, France

This paper presents an industrial aircraft engine pylon optimization study performed in the frame of the Institute of Research Technology (IRT) Saint Exupéry MDA-MDO (Multi-Disciplinary Analysis - Multidisciplinary Design Optimisation) project. It highlights the role of methodological solutions and software capabilities necessary to set up a multidisciplinary process fitting industrial constraints. Engine pylon aero-structure-Overall Aircraft Design (OAD) design space exploration and optimization processes are automatically built, based on an innovative bi-level formulation, and thanks to a platform able to deal with heterogeneous and distributed environments. The results, physically explainable, demonstrate the relevance and the maturity of the approach.

Introduction

While Multidisciplinary Design Optimization (MDO) is now recognized as a potentially powerful design approach, its deployment in the industry is not yet effective. Most industrial organizations in aeronautics are based on separate competence domains, each of them being expert of its discipline and having developed advanced disciplinary design capabilities and processes. The product design evolves sequentially, or in parallel, by solving a series of disciplinary design problems that take into account constraints from other disciplines, these constraints being fixed during the

^{*}MDO team leader, Systems Engineering and Modeling department, anne.gazaix@irt-saintexupery.com, on leave from Airbus Operation SAS, Toulouse, France

[†]Research Engineer, System Engineering and Modeling department, francois.gallard@irt-saintexupery.com

[‡]Research Engineer, Systems Engineering and Modeling department, on leave from Altran Technologies, Toulouse, France, vincent.ambert@altran.com

[§]Research Engineer, Systems Engineering and Modeling department, on leave from Altran Technologies, Toulouse, France, damien.guenot@altran.com

[¶]Research Engineer, Systems Engineering and Modeling department, on leave from Airbus Operation SAS, Toulouse, France, maxime.hamadi@airbus.com

^{||}Research Engineer, Systems Engineering and Modeling department, on leave from Airbus Operation SAS, Toulouse, France, patrick.sarouille@airbus.com

^{**}Research Engineer, Systems Engineering and Modeling department, on leave from Airbus Operation SAS, Toulouse, France, stephane.grihon@airbus.com

^{††}Research Engineer, Systems Engineering and Modeling department, on leave from Airbus Operation SAS, Toulouse, France, thierry.druot@airbus.com

^{‡‡}Research Engineer, Systems Engineering and Modeling department, on leave from Airbus Operation SAS, Toulouse, France, joel.brezillon@airbus.com

^{§§}Research Engineer, Systems Engineering and Modeling department, on leave from ONERA/DTIS, Université de Toulouse, Toulouse, France, thierry.lefebvre@onera.com

^{¶¶}Research Engineer, Systems Engineering and Modeling department, on leave from ONERA/DTIS, Université de Toulouse, Toulouse, France, nathalie.bartoli@onera.com

^{***}Research Engineer, Systems Engineering and Modeling department, on leave from ONERA/DTIS, Université de Toulouse, Toulouse, France, remi.lafage@onera.com

^{†††}Research Engineer, Systems Engineering and Modeling department, on leave from Capgemini DEMS France, Toulouse, France, vincent.gachelin@capgemini.com

^{‡‡‡}Research Engineer, Systems Engineering and Modeling department, on leave from Capgemini DEMS France, Toulouse, France, justin.plakoo@capgemini.com

^{§§§}Research Engineer, Systems Engineering and Modeling department, on leave from Capgemini DEMS France, Toulouse, France, nicolas.desfachelles@capgemini.com

^{¶¶¶}Research Engineer, Systems Engineering and Modeling department, on leave from CERFACS Toulouse, France, selime.gurol@cerfacs.fr

¹⁷Research Engineer, Systems Engineering and Modeling department, France, benoit.pauwels@cerfacs.fr

¹⁸Research Engineer, Systems Engineering and Modeling department, France, charlie.vanaret@enseeiht.fr

resolution. For instance, an aerodynamic winglet shape optimization problem is solved while taking into account a bending moment constraint at the wing root, or an engine pylon structural sizing problem is solved while taking into account thermal constraints, as well as a constraint on the shape deformation in flight.

The management of interactions between disciplines or between components is typically supposed to be a second order effect, and several loops are necessary to converge the design. In addition, if this approach can be legitimate when one can consider the components or sub-components of the aircraft independently of each other, it is rapidly proving insufficient when one seeks to integrate breakthrough technologies for which the effects of interaction between disciplines or components are much more important.

So, it has become necessary to take into account the couplings between the different disciplines during the components' disciplinary designs, and to optimize them using metrics based on the overall system performance. Considering the previous examples while using the MDO methodology, the winglet shape must be optimized while considering a reinforcement of the wing, the engine pylon must be sized by solving a coupled thermal-mechanical design problem and considering for instance a thermal blanket in addition to the pylon primary structure. Similarly, a wing-eylon multidisciplinary optimization must take into account the deformation of the configuration for the external aerodynamic shape optimization, together with flexible aerodynamic loads while sizing the primary structure of the pylon. The consequences of this sizing on the wing attachments loads should also be taken into account through a reinforcement of the wing.

From there it becomes necessary to interconnect disciplinary models and processes in integrated multidisciplinary processes and to develop the methods and tools necessary to solve MDO problems, i.e. allowing to find robust optimal solutions.

Recent initiatives have been launched to provide industry with an appropriate MDO strategy. In particular the AGILE (Aircraft 3rd Generation MDO for Innovative Collaboration of Heterogeneous Teams of Experts) EU research project, led by DLR, proposes a new paradigm based on a collaborative architecture and a knowledge architecture in order to accelerate the deployment of collaborative, large scale design and optimization frameworks in heterogeneous teams of experts [1]. At the Institute of Research Technology (IRT) Saint Exupéry, the MDA-MDO project (funded by the French Agency of National Research, and the industrial partners Airbus, Altran Technologies, Capgemini DEMS France and CERFACS) was initiated at the beginning of 2015, in the purpose of developing innovative MDO technologies from TRL3 to TRL6 (NASA scale), so takes part to the early phases of MDO methodologies industrialization [2].

The specificity of the IRT MDA-MDO project is to consider the issue of the MDO deployment in industry as a twofold challenge:

- Being able to create consistent, maintainable and explainable complex multidisciplinary processes as required to solve efficiently MDO problems;
- Taking full benefit from the existing efficient and validated sub-optimization processes managed by mono-disciplinary teams and operational in the current distributed among collaborative teams and sequential industrial design process.

The strategy followed in the project is to develop methodologies and tools capable of reconciling these two objectives, which seem *a priori* contradictory; that is why distributed, multi-level MDO formulations have been selected as opposed to the monolithic formulations such as MDF and IDF [3].

The paper is organized as follows: Section 1 presents the engine pylon study case and the associated requirements in terms of methodology and capabilities development. Section 2, we describe the developed Bi-level methodology. In Section 3, we present the MDO platform and its different services. Finally, Section 4 demonstrates the relevance of both the approach and the technical choices by presenting the different processes involved in the MDO pylon study and analysing the results.

I. Aero-structure-OAD pylon study case and associated requirements

The study case is dedicated to the XRF-1 engine pylon aero-structure-OAD (Overall Aircraft design) optimization in the context of aircraft re-engine. XRF-1 is an Airbus provided industrial standard multidisciplinary research test case representing a typical configuration for a long range wide body aircraft.

The re-engine context consists in replacing current engines of an aircraft family member by new generation engines, providing a significant improvement in terms of Specific Fuel Consumption associated to an increase of maximum thrust. In parallel, the nominal range of the re-engined airplane should be higher or equal to the original one, with possible impact on its Maximum Take Off Weight (MTOW).

This type of new engine is characterized by larger pylon and nacelles, and leads to install the engine closer to the wing,

making the powerplant integration challenging. The fairing shape and stiffness design of the pylon is multidisciplinary in essence, and has to tackle strong geometrical layout constraints as well as aero-elastic and aerodynamic interactions with wing and nacelle. A multidisciplinary compromise drives the engine positioning and the pylon shape design. Both structural weight and wing aerodynamics are affected by the engine position and the pylon height. For instance, fan blade out events generate very large loads on the pylon and are consequently critical sizing failure cases of the structural elements. For given loads, a larger pylon reduces stress constraints and therefore primary structure weight. On the other hand, a larger pylon can negatively affect the wing aerodynamics, at the point that it can require a redesign of the wing.

The objective of this study case is to assess the impact of the engine position variation on the global aircraft performances, such as the aircraft operational cost, here the Cash Operating Cost (COC) that is the cost the airline pays for flying the aircraft: fuel costs, maintenance costs for aircraft and engine, crew costs, landing fees, navigation charges. In this purpose, multidisciplinary trade-off and optimization studies of the pylon are performed, with respect to two shared design variables: the engine X-wise displacement and Z-wise displacement. In our case, the COC is mainly varying due to fuel burn, which is an aggregating criterion for mass and drag performances but also due to MTOW evolution which has potential effect on crew costs and true effect on fees and charges. Additionally, structural mass evolution, namely : Manufacturer Empty Weight (MWE) has a theoretical effect on maintenance costs. In this study, high-fidelity aerodynamic and structural simulations are necessary to capture the physics of the complex 3D flow around the pylon and provide the required performance; CFD (Computational Fluid Dynamics) is used for computing the aerodynamic performance while CSM (Computational Structure Mechanics) solver Nastran is used for the pylon structural sizing. The strategy is to benefit from the efficient existing mono-disciplinary aerodynamic and structure high-fidelity optimization processes used at Airbus to compute accurately the drag and mass information and to couple them to a lower-fidelity Overall Aircraft Design (OAD) level providing the coupling between aircraft operational performances, characteristic masses, and the COC information. Then the overall multi-level and multidisciplinary process is orchestrated by an appropriate Bi-level formulation.

To implement efficiently this strategy, a set of capabilities is required:

- Coupling procedures and algorithms (able to couple disciplines of same or different levels of fidelity);
- Automatic creation of distributed multidisciplinary trade-off and optimization processes respecting physical equilibrium (i.e. coupling between physics), and enabling to benefit from existing mono-disciplinary optimization processes, what means:
 - Automatic creation of Design of Experiments (DoE): made of Global Criterion (i.e. the COC) samples with respect to shared design variables, the Global Criterion being computed from mono-disciplinary sub-optimizations distributed on different environments (possibly different OS);
 - Automatic creation of distributed multi-level of fidelity MDO processes based on Bi-level formulations enabling the overall process to converge to a minimum Global Criterion;
- Easy adaptability of these processes following the chosen MDO formulation, or chosen design space, constraints, disciplines;
- Easy way to interface existing mono-disciplinary simulation or sub-optimization workflows to the MDO process;
- Efficient parallel execution of the workflows.
- In addition, the software platform offering these services has to provide the user with a Graphical User Interface (GUI) supporting the multidisciplinary study definition and set-up with a comprehensive, secure, and as simple as possible approach.

II. Bi-level methodology

IRT Saint Exupéry develops a family of distributed Bi-level formulations that has been identified as suitable for a direct industrial use since preserving the autonomy of each discipline as it is the case in the current industrial organization. Separating system-level and discipline-level in the problem resolution provides interesting flexibility to the system:

- Possibility to solve in parallel the disciplinary optimization problems,
- Possibility to use gradient-based algorithms for solving the disciplinary optimization problems, and derivative-free algorithms for solving the system-level optimization problem for which the number of design variables is reduced,
- Possibility to make use of different levels of fidelity in the overall MDO process, depending on the considered stage: Multi-Disciplinary Analysis (MDA) or optimization,
- Possibility to elaborate a strategy in terms of constraints handling, depending on the considered level (system level or disciplinary level).

These Bi-level formulations are different from the ones of Sobieszczanski-Sobieski and al. [4]:

- Post-optimality analyses are not required because a derivative-free algorithm is used at the system level,
- At disciplinary level, truly non-linear optimization problems are solved, and no search direction is imposed from the system level
- Finally two MDA stages are implemented in order to perform the equilibrium between the disciplines: one before the disciplinary sub-optimizations and one after them, making then use of the optimal disciplinary design variables. This enables to launch any optimization (disciplinary sub-optimization or system-level optimization) from a consistent solution.

The selected disciplines: aerodynamics performance, loads, structural sizing at a high level of fidelity, and OAD at a lower level, are managed and called throughout the Bi-level formulation, within either the optimization or the coupling stages. The following Figure 1 (N2 diagram) represents in a schematic way the exchanges between the disciplines that are considered.

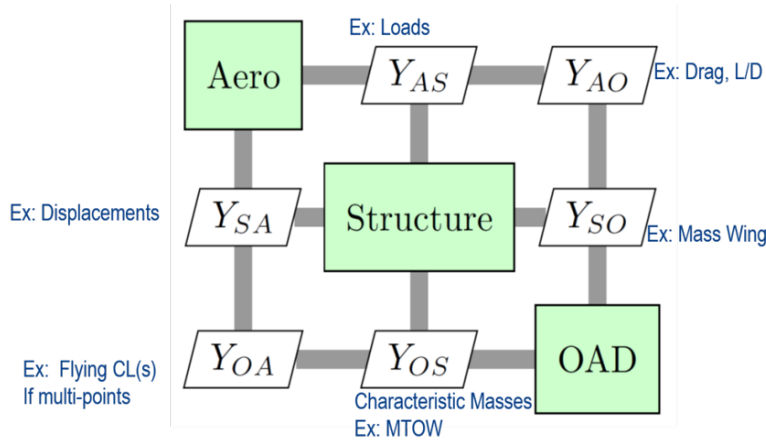

Fig. 1 N2 diagram related explaining the couplings between the three disciplines.

The overall process is schematically represented in Figure 2.

Imposing a single objective function though all the sub-optimization processes is a prerequisite to ensure the consistency of the Bi-level formulation and the convergence of the process, because the optimal shape for minimal drag is not the optimal shape for minimal weight. Therefore, having two sub-optimization problems that minimize two different objective functions with respect to their own design variables would lead to a different optimum from the optimum provided by a monolithic MDO process, based on MDF for instance, that would minimize a single objective function. As a reminder, the aim is to obtain the same optimum with the Bi-level formulation as with a monolithic formulation, so this would make the formulation inconsistent.

The objective of the use case is to maximize the overall aircraft performance on a mission, or on a set of missions. A straightforward way to measure the performance of a system is to aggregate all the criteria into a cost, which can take into account for various performance figures that impact the product life cycle, such as manufacturing, fuel consumption, crew costs, airport fees, recycling costs. Concerning the pylon design, its main impact on the product is through the primary mass, and the aerodynamic performance (drag). These figures impact then the overall aircraft performance through the integration of the fuel burn over the mission and the evolution of MTOW and MWE. The instant fuel burn at time t , for the design variables χ , at the operating conditions (payload, altitude, Mach) α , total aircraft weight w , Lift-over-drag ratio LoD , and fuel specific consumption C_s is given by Equation 1. The total fuel burnt on the mission is the integral is given by Equation 2, for more details, see [5], chapter 1, p18-23.

$$\frac{dw(t, \chi)}{dt} = - \frac{C_s(\chi, \alpha(t))g(\alpha(t))}{LoD(\chi, \alpha(t), w(t, \chi))} w(t, \chi) \quad (1)$$

$$\Delta_w(\chi) = - \int_{t=t_0}^{t=t_f} \frac{dw(t, \chi)}{dt} dt. \quad (2)$$

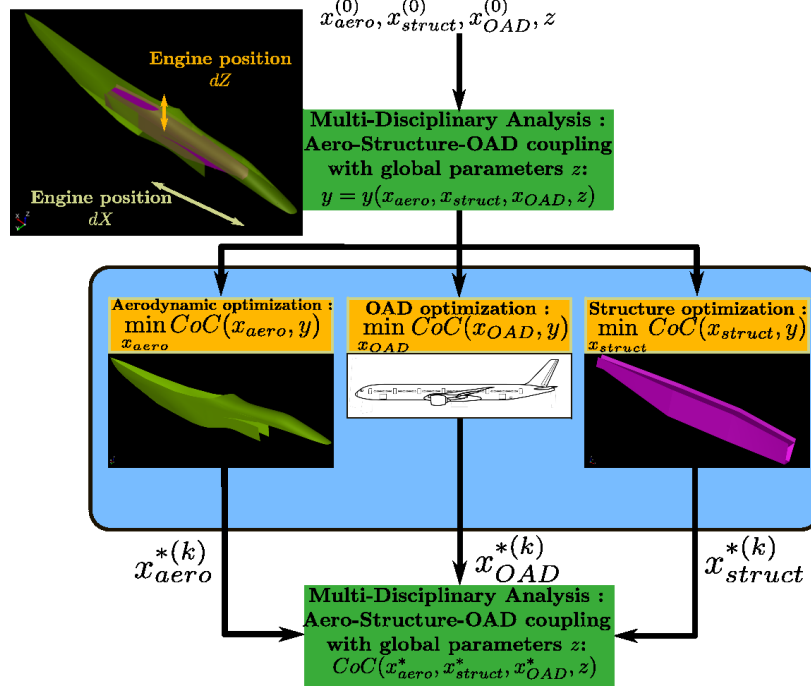

Fig. 2 Bi-level formulation used by a GEMS DoE scenario.

From the aerodynamic design perspective, Equation 2 shows that the optimal shape for minimal instant fuel consumption is the shape of maximal LoD , while the optimal shape for minimal mission fuel consumption is a compromise between the drag performance at all the operating conditions encountered in flight in the time integration, ie the $\alpha(t)$ function. This compromise can be addressed through a multipoint optimization. subsection IV.B.2 describes the link that has been implemented between the aerodynamic optimization process and a mission tool to compute the COC at a minimum CPU cost.

From the structural optimization perspective, the shape of minimal instant fuel burn is the shape of minimal weight. But two shapes having identical weights may have different centers of gravity (CG), which has an impact on the aircraft balance, handling qualities, so finally its drag or the weight of other systems, so the overall fuel burnt on the mission. Considering the present study, only the direct dependency of the COC to the structural weight is taken into account. The engine X position has a second order influence on the fuel burn through CG changes, compared to the primary pylon mass, this effect is even null if a trimming fuel tank is used in the horizontal tail plane. Besides, the derivative of COC with respect to the weight being always positive (a heavier aircraft, everything else equal, is always less efficient), the computation of COC is not required within the structural sizing loop, and the structural optimization process minimizes the pylon mass. The COC gain due to the sizing process is computed just after it, as a post-processing.

From an OAD perspective, the constraint to keep constant the nominal mission range (i.e. the range of MTOW mission) has the effect to amplify individual structural mass or aerodynamic efficiency evolution throughout the mass-mission snowball effect. Basically, this snowballing is due to the fact that any additional kg of structure to be carried over the nominal ranges requires additional amount of structure to carry itself as well as the required additional fuel with a final impact on MWE and MTOW and so COC. The OAD module estimates the link between MTOW loads and structural mass for all components (except the pylon) through simple semi empirical models that have been tuned to match with XRF-1 configuration. In the context of a re-engined airplane, a potential decrease of MTOW would probably be turned into additional range which has a positive effect on revenues whilst a potential increase of MTOW may generally be taken out of existing structural margins (which then cannot be affected to other evolution) or may require some reinforcements. All in all, the evolution of MTOW is not neutral and the amplification effect introduced as such in the COC is a quantification of the global overall value benefit or loss that can be taken out of the pylon optimization.

III. MDO platform

A. Main components

Simulation Life Cycle Management (SLM) platforms aim to streamline simulation software and produce data so that product designers take full benefits from numerical simulations without having to deal with the underlying IT (Information Technology) complexity.

The main drawback of such platforms is often the lack of flexibility to add new simulation processes, requiring a high level customization of the platform software which is not suitable in the MDO context. MDO scenarios can potentially involve hundreds of combinations including different optimization strategies and algorithms, workflow technologies and domains tools. The MDO user shall be able to setup MDO strategies in a flexible way to combine those technologies and turn them into executable processes.

A MDO scenario execution generates a large set of heterogeneous data that refer to information that do not have a pre-defined data model, since every new simulation software that extends the platform comes with its own data model, and are not known in advance. In a MDO context, data include MDO information relevant to convergence status of the optimization and physical data. Depending on the selected disciplines, physical data and design variables differ. Depending on the MDO scenarios and formulations, the information relevant to monitor the convergence differs. Describing all the data produced in a pre-defined data model could be achieved but the user will lose the required flexibility in case of any change at disciplinary or MDO level. Dynamic workflow creation and heterogeneous MDO content are the key reasons why a new generation of SLM platform is required for MDO.

In the MDA-MDO project, a MDO platform has been developed, based on these observations. Its main components are:

- GEMS [6], the Generic Engine for MDO Scenarios, creating and managing all MDO scenarios and formulations while being independent of simulation tools and optimizers,
- The optimization algorithms, surrogate modeling, design of experiments software, interfaced with GEMS.
- The graphical user interface, used to create, run and monitor the MDO scenarios, as well visualize results to assist decision making from the MDO results,
- The workflow interfaces: the software interfaces between GEMS and the simulation tools (typically Aerodynamics, Structure, OAD and Loads),
- The Data Manager: a component responsible for storing all simulations and MDO data generated during execution.

In the following, we focus on the GUI component (subsection III.B), providing a real added-value to the end-user.

The MDO platform is built in the purpose to be easy to interface to external workflow engines that manage complex workflow chains. In the aero-structure-OAD pylon study case, two workflow engines have been used: Model Center [7] for integrating the structural optimization, and WORMS, a workflow engine developed at Airbus for aerodynamic shape optimization [8].

Based on these distributed simulation workflows (Model Center used on Windows, WORMS on linux), a python framework has been developed to ensure the orchestration between them and GEMS, through their interfaces, and a parallel execution strategy has been set up, see subsection III.C.

B. Graphical End User Interface

The GUI based on the Eclipse RCP/SWT and Sirius modeling workbench allows to define all steps required to create and execute a GEMS scenario:

- definition of the study (generic configuration of scenarios),
- definition of the scenario (formulation, algorithm, disciplines, design space, constraints),
- definition of the post-processing.

Figure 3 shows how the user has to define a Bi-level scenario to solve the Sobieski's Super Sonic Business Jet (SSBJ) test case taken from the reference article by Sobieski [4].

The GUI provides help to enter user data and checks errors or inconsistencies. The platform builds a dynamic link with GEMS API to take into account automatically all evolutions of different workflow managers (disciplines, configurations, . . .). Created instances of scenarios can be easily modified and executed or re-used in other studies. Using the Eclipse plug-in mechanism component based and Service oriented, the platform will be fully compatible with other Eclipse RCP components or workflow engines modules.

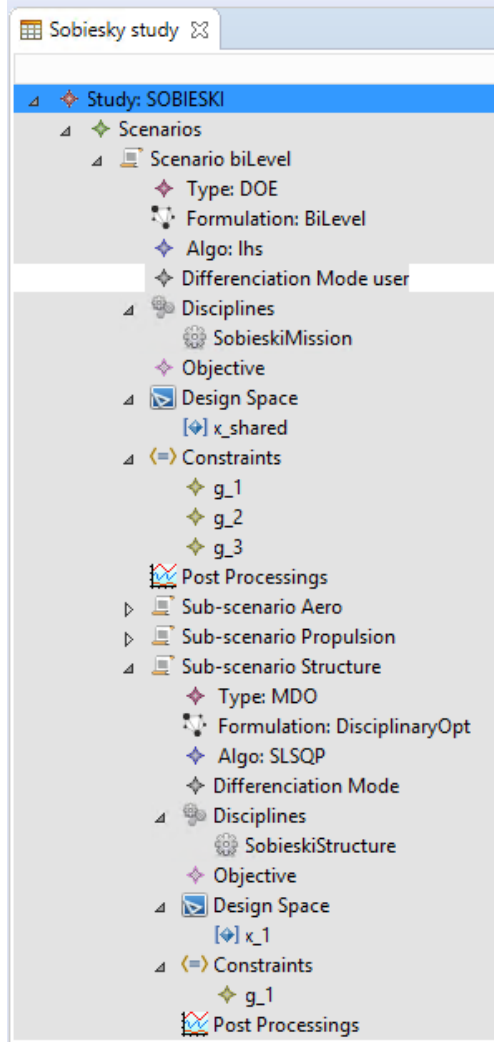

Fig. 3 Table view of the SSBJ test case: the system-level and sub-scenarios (Aerodynamics, Propulsion and Structure) of the Bi-level formulation are shown in a hierarchical tree. Details about the system-level scenario (Scenario biLevel) and the structure sub-scenario (Sub-scenario Structure) are expanded.

C. On the four levels of parallelization of the MDO process

The restitution time, ie the time a user has to wait in order to obtain the results of the optimization, is a key factor for enabling MDO in industry. Large computational resources are usually accessible, so taking advantage of HPC infrastructures with thousands of CPUs is necessary.

First, the simulation processes are classically parallelized within the physical simulation software, using the MPI and OpenMP technologies for instance. Such software are used off the shelf, such as the CFD solver elsA-ONERA [9], and CSM solver Nastran used for structural and loads simulations, which are parallelized using such technologies.

Second, for both aerodynamics and loads, the simulations are performed for multiple operating conditions, ie the Mach number, Lift coefficient, mass cases etc. These simulations can be run in parallel, using multiprocessing on the HPC, thanks to the features of the workflow managers combined with HPC's load schedulers and queue systems.

A third level of parallelism is provided by the Bi-level MDO formulation itself. The aerodynamic and structure processes can be executed independently. This is performed through multi-threading in GEMS.

A fourth level of parallelism of the process is obviously the Design of Experiments level on the shared design variables for the trade-off process. The computations associated with each engine position are independent, and therefore, GEMS uses a multiprocessing parallelism to take advantage of it. This is not possible for a full MDO process, since most optimizers call the objective function and constraints for a given value of the design variables, and must wait for

the results to compute the new iteration.

Overall, this multilevel parallelism allows to perform a trade-off on five engine positions on more than 750 CPUs, and has a restitution time of 2.5 days, while the sequential CPU time is of more than 3 years.

IV. Engine pylon study: processes and results

In the study case implemented in the MDA-MDO project, the Airbus XRF-1 transport aircraft configuration is used as the reference geometry.

In a first sub-section, we describe the principles of the multidisciplinary parametrization. A second sub-section presents the different processes involved in this study: first the disciplinary (structure then aerodynamic) optimization sub-processes, then the aero-structure trade-off and optimization processes. Finally, a third sub-section presents and analyses all results: first the results of the disciplinary trade-off and optimization studies, then results of the aero-structure trade-off and optimization studies.

A. Multidisciplinary parametrization

The goal of the MDO parametrization is, from variables (Z) shared among all disciplines, to produce consistent disciplinary models. In the present study, these Z shared design variables are the X -wise and the Z -wise engine displacements, the X -axis being oriented towards the rear of the aircraft and the Z -axis upwards (see Figure 4).

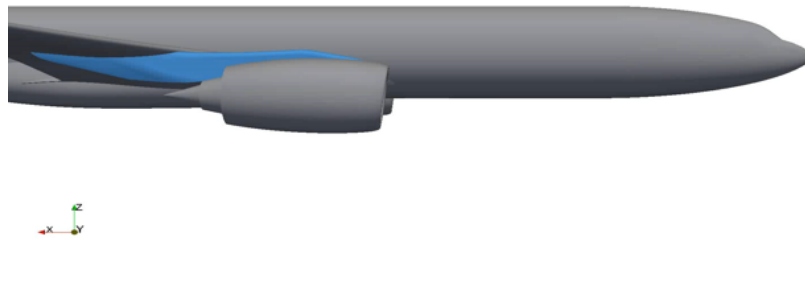

Fig. 4 XRF-1 transport aircraft configuration.

Setting up the MDO parametrization requires the following main steps:

- Definition of the shared parameters by aerodynamics and structure
- Definition and computation of disciplinary (aerodynamic and structure) private design variables
- Generation of two disciplinary CAD models (one for aerodynamics and one for structure) from both shared and private parameters.

This enables to have:

- Consistency of the parameters while enabling different geometry definitions,
- Use of different CAD engines (Catia for structure and the PADGE Airbus parameterization engine [5] for aerodynamics).

The consistency of the disciplinary CAD models has to be ensured by the parametrization, which is use case dependent and not straightforward (drawback of not having a single CAD). It can be checked by loading both disciplinary CAD models in a CAD engine.

All parameters and variables are defined in the PADGE format, and a hierarchy of parameters is built:

- the shared parameters and design rules that provide all necessary parameters to build the pylon box,
- the structural parameters enabling the structural FEM construction,
- the aerodynamic parameters enabling the construction of the pylon external shape.

Each discipline is in charge to respect pylon box limits:

- As regards the structure, the problem is easier to solve. Actually, the structure geometry is based on the pylon box itself and no element is external to this geometry (inherent to the XRF-1 model). However, if in another concept, the structure is not purely internal, the generation of the geometry should be done taking into account the problematic.
- About the aerodynamics, it is required to ensure, during the optimization process, that the aero shape stays outside the pylon box. A first approach consists by setting constraints on aerodynamics parameters. But it could expose the solver to convergence complications. It is favored to set bounds on some aero parameters (especially curve tangency) in function of the pylon box. For wet surfaces, good parameters should be fixed to respect the shape (panel boundaries).
The curvature of panels is not decisive for the structural sizing. The gap between both model in term of curvature of wet surfaces is not considered as critical.

B. Processes

1. Structural optimization and loads computation

The structure discipline is associated with an automated workflow designed for providing information such as the mass of the primary structure with respect to geometrical modifications of the system optimizer. This workflow is developed for a pylon optimization but the process is generic enough to be adapted to other component.

According to the MDO strategy, each discipline must minimize the same function, the COC. As explained in section II, it is however sufficient to minimize the mass to decrease the COC. That's why, the structure workflow consists of a sizing optimization minimizing the structure's mass. The link with the COC, to translate the gain in term of mass into mission performance, is delegated to GEMS.

Figure 5 illustrates the process implemented for optimizing the primary structure of the pylon with respect to a geometry change. It needs three kinds of inputs: a set of private design variables (X_s), a set of global variables shared with other disciplines (Z_i) and a set of different book cases. Actually, the global variables are defined as parameters from the point of view of the structure discipline. They are given by the system level and it is forbidden for any disciplines to modify them.

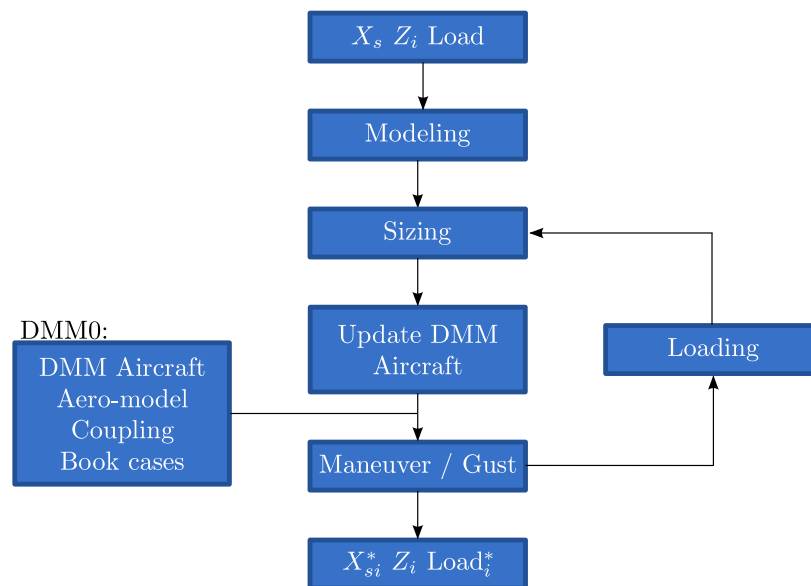

Fig. 5 The structure optimisation process

Using these inputs, the process generates a parametric geometry thanks to two Airbus tools based on CATIA v5

scripting methods, modeling respectively the pylon box and the detailed geometry. The pylon box represents only the external shape, the panels and the location of wing and engine attaches. The detailed geometry includes stiffeners, ribs, corners, attaches, etc. Both tools have been developed with a common spirit. The user assembles templates of design concepts that are available in a library provided by the tools. Then, these template models are updated by the automatic process. In order to provide input parameters to the tools, the parameterization of the structural model is composed of two levels. The tools update reference models, built with different templates, with a set of parameters. The implicit rules contained in the templates and the parameters exposed to the user constitute a first level of parameterization. An upper level links these parameters, exposed by the tools, to each other in order to model an appropriate overall shape of the component. Figure 6 summarizes the principles and philosophy of parameterization implemented in the process. For a new study, it is mandatory to prepare some reference models that are then updated by the automatic process. This preliminary phase may take a few days if the templates of desired design concepts are already implemented in the tools. Otherwise, the development time is driven by the development of new features in them.

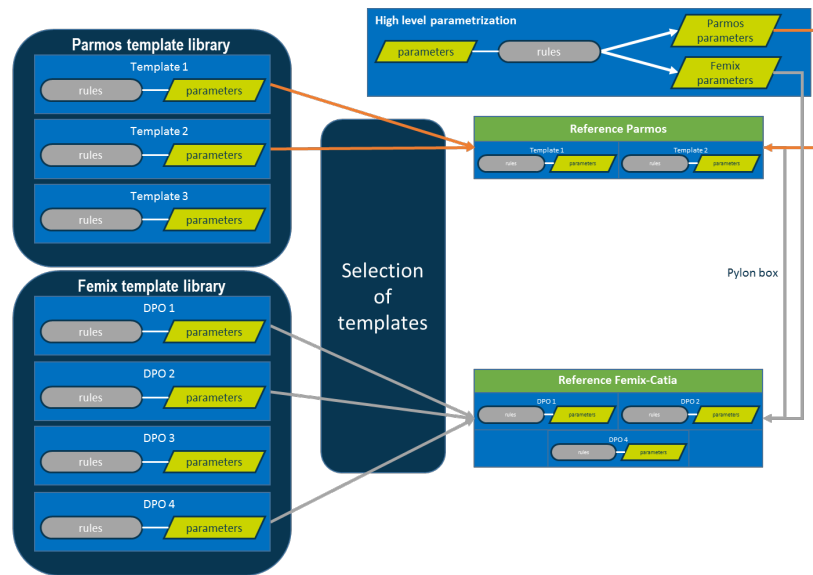

Fig. 6 The structure parametrization process

An Airbus tool who is dealing with Nastran model generation based on CAD model for static or optimization Nastran Solution, is in charge of the finite elements modeling, the generation of the stress model and the linking with the sizing tool SOL200 that is the MSC Nastran solution dedicated to linear structural optimization. In this process, a new FEM (Finite Element Model) is generated for each new geometry and the topology. Even if the topology is not optimized here, it may be modified depending on implemented rules in the parametrization. For instance, the number of stiffeners could change depending on the engine position. The pylon is loaded introducing equivalent static torsor on the engine center of gravity. This tool builds a full stress model representing materials, properties (profile shape, physical sections, panel properties, and composite layup) on several location granularities. This concept, based on the topology, will permit to be fully independent of the model elements. Moreover, thanks to the stress model applied on the geometry, it is possible to generate not only a GFEM (Global Finite Element Model), to extract internal loads, but also other types of model for other physics (thermal analysis, acoustics, rapid sizing). Specific capabilities were developed to take into account additional needs in terms of pylon sizing:

- the symmetry to minimize number of variables in SOL200,
- the management of the splicing zone around panel and spar junctions,
- the management of visit holes areas,
- the generation of a classical stress model for stiffened panels.

According to the specifications, the structure optimization chain provides a preliminary sizing of the pylon and takes into account several structural feasibility criteria such as ultimate strength, fatigue & damage tolerance, buckling, post-buckling and flutter. The structural optimization checks, for several flights, ground and crash load cases, that the structure is feasible which means:

- all reserve factors (RF) are greater than 1.0,
- all fatigue lives exceed the aircraft life,
- all damages can be tolerated until the next inspection,
- no flutter instabilities appear inside the flight envelope up to a certification limit of 1.1 times the diving speed.

One of the main multidisciplinary needs is to be able to update the applied loads while changing the sizing properties. The next section details the response to this requirement. The principle of structural optimization is to minimize weight with respect to different types of variables such as materials, thicknesses, cross-sections, etc. Therefore, the structural optimization deals with both continuous variables, which represent panel thicknesses and cross-sectional areas, and discrete variables, which hide the selection of design concepts, materials, types of stiffeners, etc. The optimization, at the same time, of continuous and discrete variables is not trivial, and not taken into account in this study case. PRESTO [10], [11] is used for the rapid sizing of the pylon composite structure; it delivers an optimized catalogue selection for trade-offs and optimum thickness/area distributions for sizing within this catalogue selection. And thanks to catalogues it can also deliver a detailed definition of elements including profile details and stacking sequences. The choice of catalogues allows to perform trade-offs regarding for example the material, the profile type and even some stress margin policy. It also gives a weight indicator (weight of the optimized finite elements) and the updated finite element model.

In the present study, the structural optimization problem handles only continuous design variables in order to account for stiffness-driven criteria, such as engine displacement constraints; it can be formalized as follows:

minimize $Weight(t, A)$ w. r. t: $(t, A) \in \mathbb{R}^{2N}$ s. t: $\underline{t} \leq t \leq \bar{t}$ $\underline{A} \leq A \leq \bar{A}$ $RF(t, A, IL(t, A)) \geq 1$ $G(t, A) \geq 0$	where: t , thickness of skins A , area of stringers p , number of categorical variables $\underline{t}, \bar{t}, \underline{A}, \bar{A}$, box constraints RF , reserve factor IL , internal loads G , overall constraints
---	--

In fact, RF are factors dedicated to the determination of structural strength. In this formulation, the RF are a concatenation of RF_i vectors containing all constraints (for all failure modes) per element. In addition, the overall constraints represent all those that depend on the stiffness matrix of the structure, such as the engine displacement for example.

This structure optimization process sizes the model with SOL200 in which different types of optimization are available, such as the property, the shape or the topology optimization for instance. In our case, we are interested by the optimization of models properties. Concretely, each finite element of a single panel is grouped into a set. It is associated to a design variable representing the thickness of the panel. An equivalent process links 1D elements, describing stiffeners, to a design variable representing the area.

The structure is subject to specific constraints. Actually, for the pylon box, a panel is related to six responses (major principal stress, minor principal stress and Von Mises stress at the top and the bottom of the panel). Two constraints are defined for each response (for the elastic and the rupture behaviour i.e. limit and ultimate loads). For a stiffener, only the axial stress is analyzed. It induces six constraints per stiffener (tension and compression for limit and ultimate loads). On Splicing area only the thickness is studied and they are linked to fatigue loads. A fatigue allowable is introduced on the major principal stress (at the top and the bottom) for each panel. Additional constraints about the global stiffness of the pylon are defined by limiting the displacement of the engine point under unitary loads.

Modifying the pylon geometry, loads are impacted and need to be updated in order to assure that the results are physical. Moreover, the sizing itself influences the introduced loads. Aero-elastic analyses are computed after each sizing in order to take into account the influence of the new structure on the aircraft internal and aerodynamic loads redistribution. For the pylon case study, static and dynamic loads are updated at each loop for sizing whereas flutter is assessed only as a design constrain. Flutter ensures the viability of a previously sized design but is not an optimisation objective. The following static and dynamic load conditions are investigated for the pylon case study:

- Manoeuvre
- Discrete Gust
- Continuous Turbulence

- Fan Blade Out
- Dynamic Landing
- Wheels up landing
- Engine Bookcases
- Dynamic Taxi
- Emergency landing conditions
- Fatigue

Because some of the previously defined load conditions are mainly driven by engine characteristics, they will be considered as constant for the pylon use case. Therefore, taxi loads, Engine Bookcases, Wheels up landing and Fan Blade Out (FBO) are out of the scope of the load update loop. Fatigue and emergency landing conditions are not targeted as critical sizing load cases for our study, so they are out of the scope of the load loop. Manoeuvre and gust book cases are updated by using MSC Nastran aero-elastic solutions (SOL144 and 146) based on doublet lattice method (DLM). Actually, in the structure optimization process, it is not necessary to compute the loads with high-fidelity CFD models.

Aero-elastic analyses are based on a finite element model of the aircraft. This model is used to compute flexible manoeuvre loads, flutter divergence speeds and aircraft response due to turbulences. To achieve these computations, aero-elastic analysis presupposes a structural model with both stiffness and inertia data, an aerodynamic model and an interconnection between both of them. The analysis should solve the following equation:

$$[M]\{\ddot{u}(t)\} + [C]\{\dot{u}(t)\} + [K]\{u(t)\} = F_{aero} + F_{other}$$

where: $[M]$ is the mass matrix
 $[C]$ is the structural damping matrix
 $[K]$ is the structural stiffness matrix
 $\{u(t)\}$ is the displacement vector (rigid body and elastic displacements)
 F_{aero} is all aerodynamic forces (from rigid body motion and structure deformation)
 F_{other} is all other forces (thrust, landing gear. . .)

Structural internal forces, stiffness and mass matrix are given by the GFEM of the aircraft. This model includes all the major components and is part of the XRF-1 model. The structural internal forces are deduced from mass and stiffness properties of each finite element. In fact these forces are given by:

$$\{F_s\} = [M]\{\ddot{u}_s\} + [K]\{u_s\}$$

where: u_s are nodal points displacements (degrees of freedom). On the other hand, aerodynamic forces are obtained from an aerodynamic model represented by DLM of the aircraft.

The structure optimization is performed within a certain scope, with some assumptions. Firstly, properties of the engine are constant, its attachments are considered as fixed in the engine's axis system. Moreover, the pylon's design concepts regarding the engine integration is an invariant of the study. So, the type of engine and wing attaches remain unchanged. Nevertheless, as it is said before, the topology of the pylon is automatically adapted to the new geometry. Due to a large shape modification, these fixed concepts could be not relevant to reach the optimum. In this case a manual preparation of templates could be required.

2. Aerodynamic optimization for minimal COC

As explained in section II, the aerodynamic shape optimization has to minimize an objective function that is the COC, with respect to some aerodynamic variables to control the detailed shape of the pylon, and to several geometrical constraints. The Figure 7 presents the corresponding process, where the aerodynamic optimization is coupled to a mission tool to compute the COC.

The COC is computed over specific missions thanks to a mission simulation tool, provided that proper polars (Cd as a function of Mach and Cl) are given. The aerodynamic optimization process combines the adjoint-based CFD multipoint pylon optimization process developed in [12], with an aircraft mission performance optimization adaptive polar methodology. It relies on surrogate models of the drag with respect to the flight envelope (Mach, Cl). This "Aero To COC" process is fully described in [13], and illustrated on Figure 8.

In order to minimize the number of CFD computations, an adaptive polar methodology is applied, allowing to automatically refine the polar (Mach, lift coefficient Cl) discretization according to the mission, using derivatives

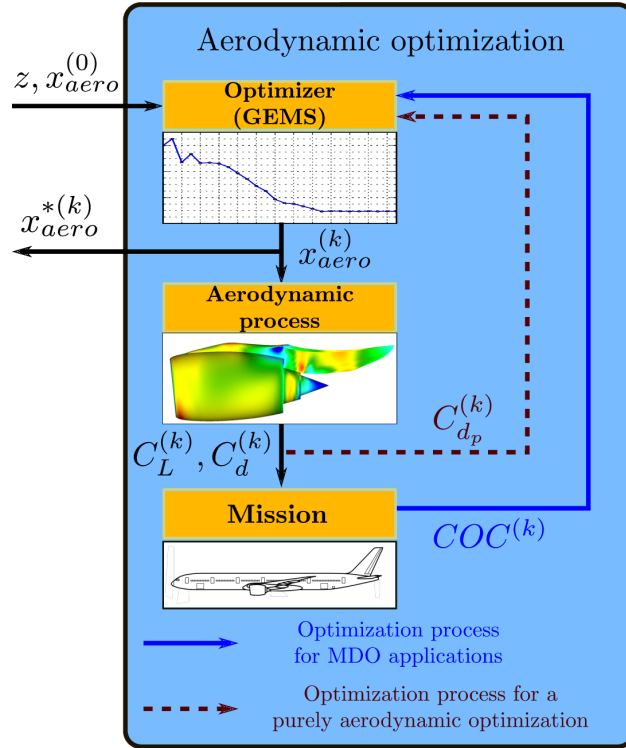

Fig. 7 Aerodynamic optimization process [12] coupled with a mission tool to compute the COC. The traditional approach based on the drag minimization is shown in red for comparison with the present MDO approach in blue.

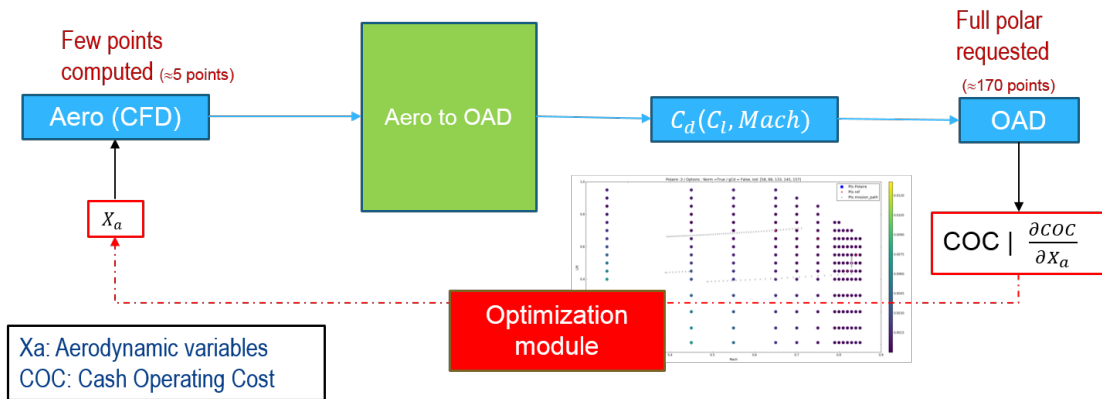

Fig. 8 Aerodynamic optimization for minimal COC

provided by automatic differentiation of the mission simulation tool. This allows to detect the areas of the polar that are important from the aircraft mission’s point of view. Figure 9 displays the resulting refined polar.

Then, from these dozens of operating conditions used in the polar to compute the mission, the Gradient Span Analysis (GSA) algorithm is used to downselect the operating conditions within this areas, in order to minimize the CPU cost of the optimization [5, 14]. Finally, surrogate models are built to extrapolate the drag computed from these selected CFD points on the full polar, with an automated refinement in order to minimize the first order error on the COC computation performed by the mission simulation tool.

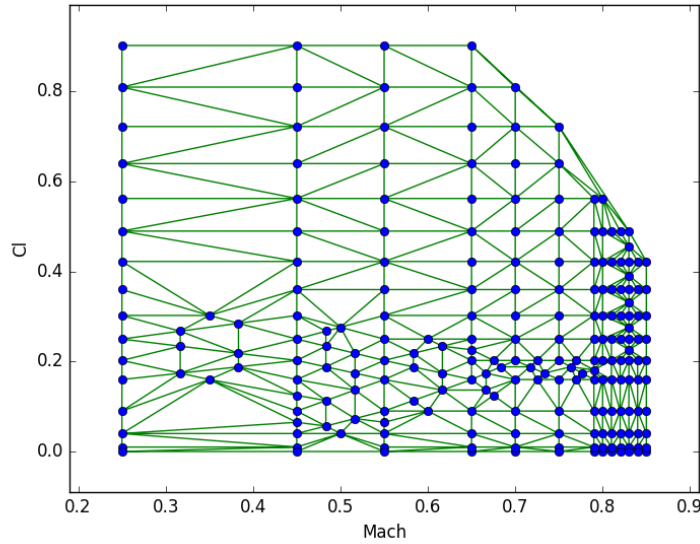

Fig. 9 Refinement step on the 170 initial operating conditions, inducing 220 points

3. Pylon trade-off process

The Bi-level formulation described in section II, involving the three disciplines: aerodynamics, structure and OAD, the OAD providing the COC, has been first applied in the purpose of a trade-off study before to be applied for true MDO.

In the first MDA stage of Figure 2 the following couplings are considered:

- Rigid high-fidelity aerodynamics (CFD) is considered in the aerodynamic optimization, the hypothesis being that the pylon is rigid in cruise, and that the wing shape is the same for all Cl conditions;
- A strong aero-elastic coupling is performed for the loads computation, using MSC-NASTRAN aero-elastic solutions based on DLM;
- An iterative coupling is considered between the loads computation and the sizing performed by MSC NASTRAN SOL200;
- At each iteration of the aerodynamic optimization, a strong coupling is performed between the CFD multipoint simulations and the OAD mission performance evaluation, the CFD providing drag coefficients information to the OAD mission tool that computes the COC that is the objective function of the aerodynamic optimizer;
- Weak coupling is performed between the structural sizing and the OAD mission performance evaluation, the OAD discipline being chained to the structural optimization as a post-processing, giving the minimum COC from the minimum mass; the influence of the pylon mass on the CG is not considered

This is illustrated with a more detailed N2-diagram on Figure 10.

The trade-off process is represented on Figure 11. It has to be noted that a linear surrogate discipline is used to compute the COC from the delta drag and delta pylon mass computed by aerodynamics and structure instead of using the full "Aero To COC" process in order to reduce the computation time. Given the small variations of drag and mass, the COC behaves indeed linearly.

The resolution of the aerodynamic and structure optimization sub-processes leads to the identification of optimal values for the disciplinary design variables. The corresponding gains in terms of COC are evaluated and compared (COC gain coming from the aerodynamic optimization versus COC gain coming from the structural optimization).

Finally, the overall COC of the consistent aero-structure configuration is computed from the optimal values of drag coefficients and mass thanks to the full "Aero To COC" process.

Aerodynamics Low-fi (DLM)	Aero forces				
Displacements	CSM (Nastran)	Loads			
	Finite Element Model (DMM)	Structure Sizing			Pylon Mass
			Aerodynamic optimization High-fi (CFD)	Drag, lift, on 3 points	
				Aero To OAD	Drag, lift on the full polar
			COC		Overall Aircraft Design

Fig. 10 N2 diagram related explaining with more details the couplings considered in the Bi-level formulation.

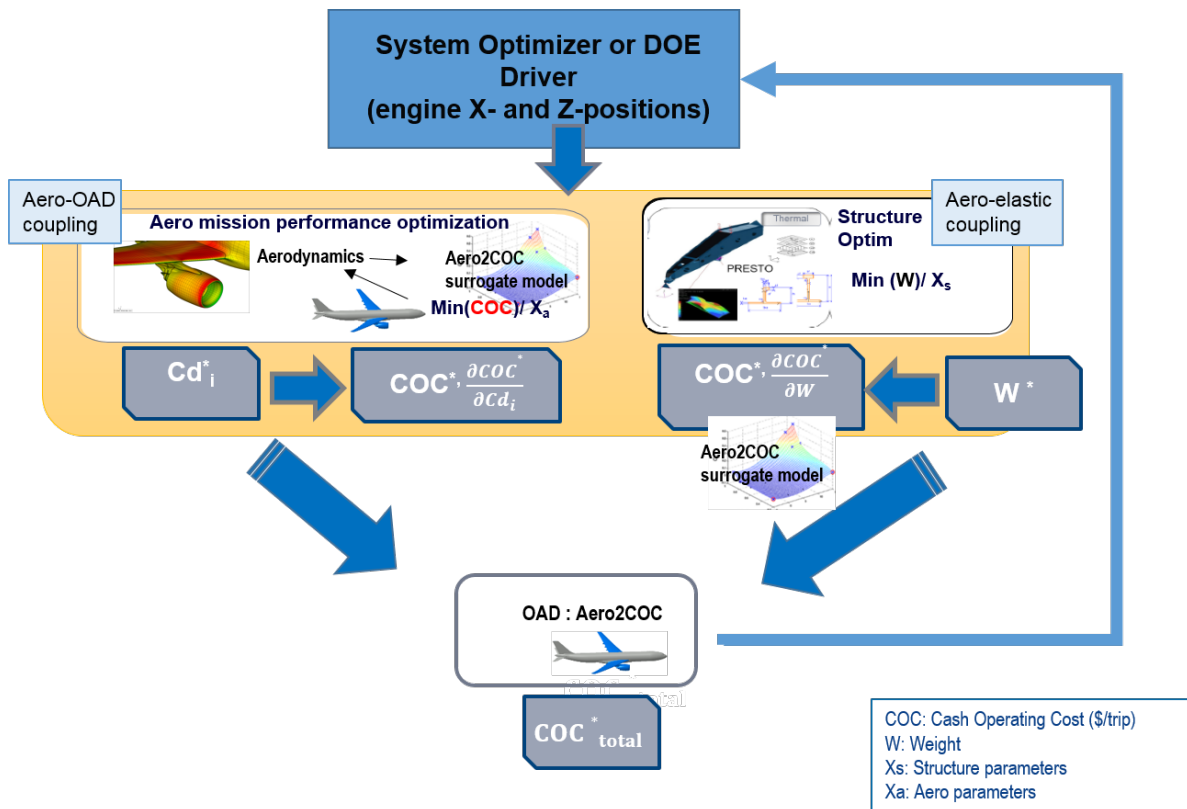

Fig. 11 Bi-level based trade-off or MDO process.

4. Pylon MDO process

Once the multidisciplinary trade-off process is set up, it is straightforward to transform it in a true MDO process. Instead of evaluating each point of a Design of Experiment parametrized in the shared design variables Z , an optimizer is applied in order to find the optimal value of the variables Z , i.e. that minimize the COC (see Figure 11).

C. Results

This section presents results obtained in term of structural optimization, aerodynamic optimization, then aero-structure optimization for the following X-wise and Z-wise engine displacements: $dX \in [-300mm, +200mm]$, $dZ \in [0, +150mm]$. First, for each of these three cases a trade-off study is performed:

- A factorial DoE is built that provides the COC gain (compared with a reference value of 50 000 \$) for each point (dX , dZ),
 - The optimum engine position is determined from the comparison of the DoE points regards to the COC gain value.
- . Then, results of a true multidisciplinary optimization are presented, the optimizer enabling the automatic identification of the optimum values dX , dZ and COC gain.

1. Structure trade-off results

The structural optimization problem presented in IV.B.1 is solved by using NASTRAN SOL200 and standard NASTRAN responses with a model dedicated to static linear analysis. Therefore only stress limits can be addressed. These constraints concern maximum, minimum principal and Von-Mises stresses in skins and axial stresses in stringers. Ultimate load cases for failure cases like Fan-Blade-Off loads are used with material stress limits. Limit load cases for failure cases like 1G cruise flight with gusts are used with equivalent fatigue stress limits. The structure optimization process is based on gradients and a full sensitivity analysis is performed including the sensitivity of internal loads through the stiffness. Global constraints like displacement constraints are used.

An extended work is on-going to couple NASTRAN SOL200 with PRESTO skill constraints coming from analytical buckling / post-buckling codes.

In this study, maneuvers and gusts are updated as it is explained in the section IV.B.1 and ground, FBO, engine and fatigue loads are considered as fixed. Flutter is computed as a post-processing of the structural optimization.

A typical convergence of the structure optimization process is described on Figure 12 and Figure 13. The convergence is rather smooth with a progressive increase of the number of active constraints linked to the weight decrease.

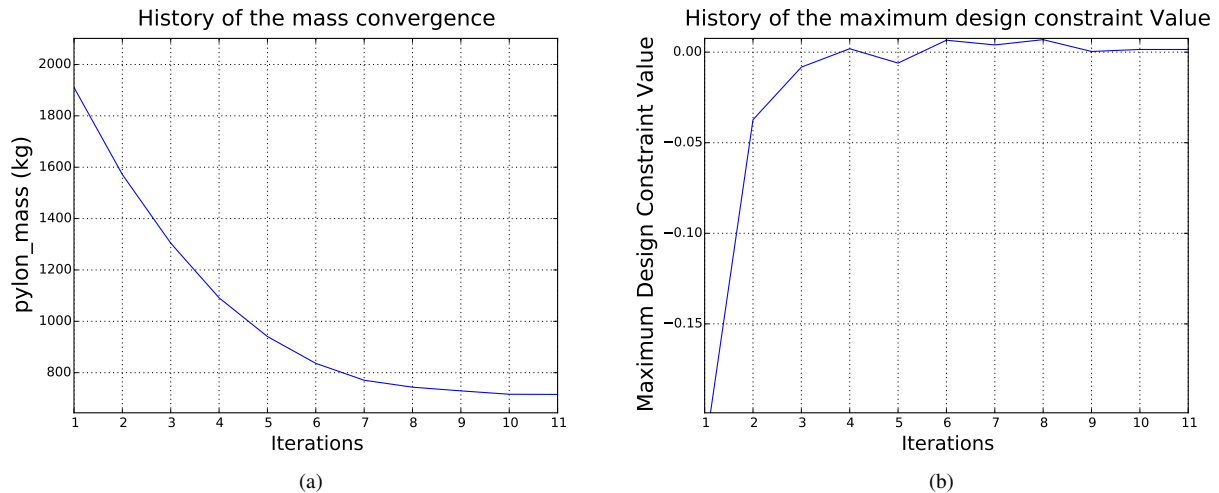

Fig. 12 History of the structural optimization

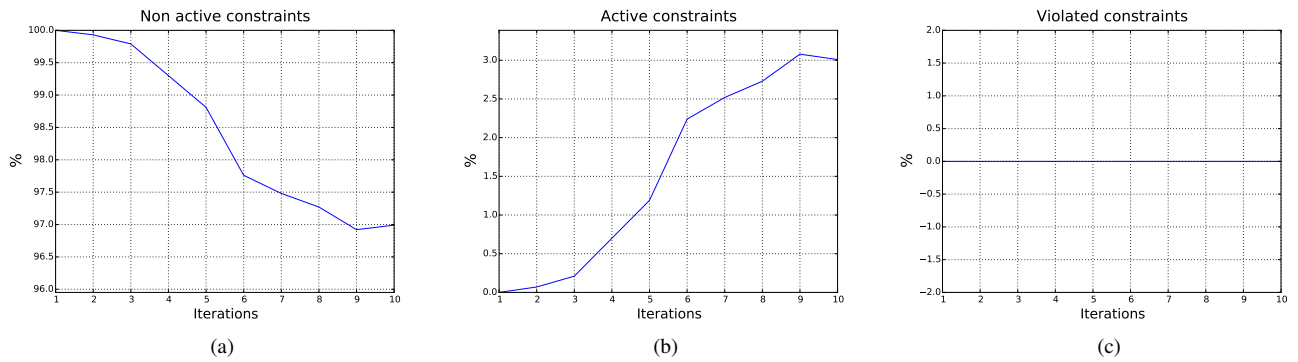
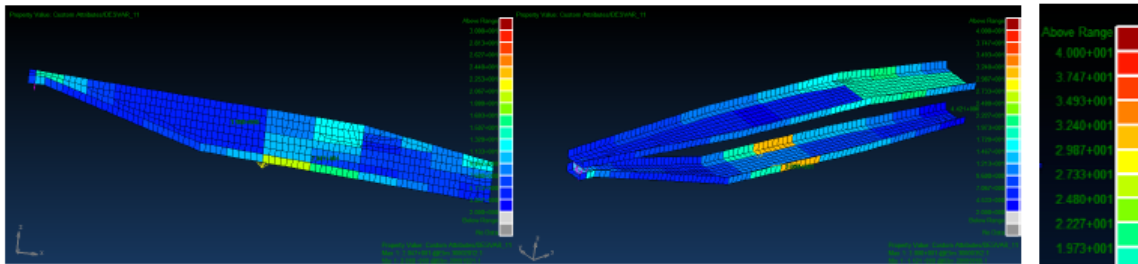

Fig. 13 History of constraints

The saturation of constraints is rather limited because stress constraints are not driving alone the convergence: the displacement bound is also active and limits the number of active stress constraints. This is the reason why we do not have stress constraints active in the side panel while the stress constraints are not saturated as shown on Figure 14. The

■ Panels' thickness



■ Critical loads

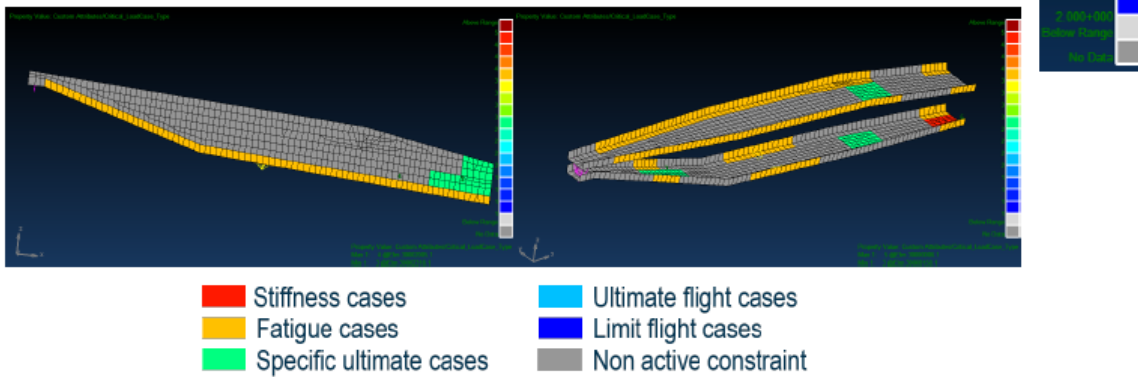

Fig. 14 Panels' thicknesses and critical loads

thickness closed to rear engine mount is important. It is explained by the low fidelity of the attach modeling. Actually, the directions of the attach are modeled, then they are linked to the structure with rigid element. Different strategies of modelization of attach and rib feet have been evaluated and their impacts on the sizing are not negligible. The critical

loads appear to be the fatigue loads which are mainly driving the sizing properties of corners. Static load cases are also critical in the rear part of the pylon.

Flutter behavior has been checked for every pylon configuration of the DoE, and flutter even if sensitive is never critical. This generally justifies the fact that we do not include it necessarily in the MDO process but rather in a second time if flutter has to be cured. Typical flutter curves are provided on Figure 15.

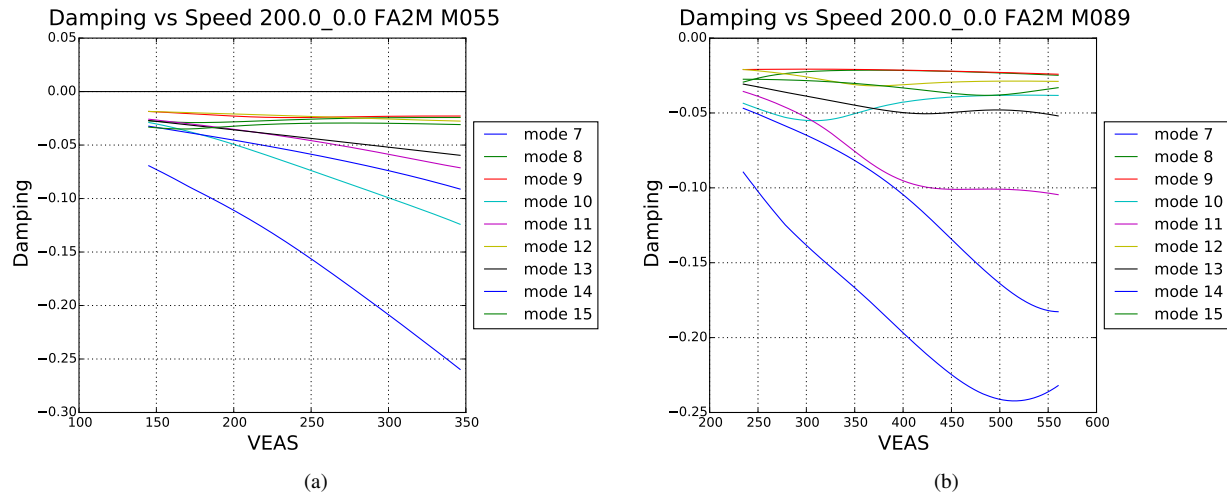

Fig. 15 Flutter curves

Results in terms of ΔCOC (comparison of the COC of a sized geometry with the COC of the initial geometry) are given in Figure 16.

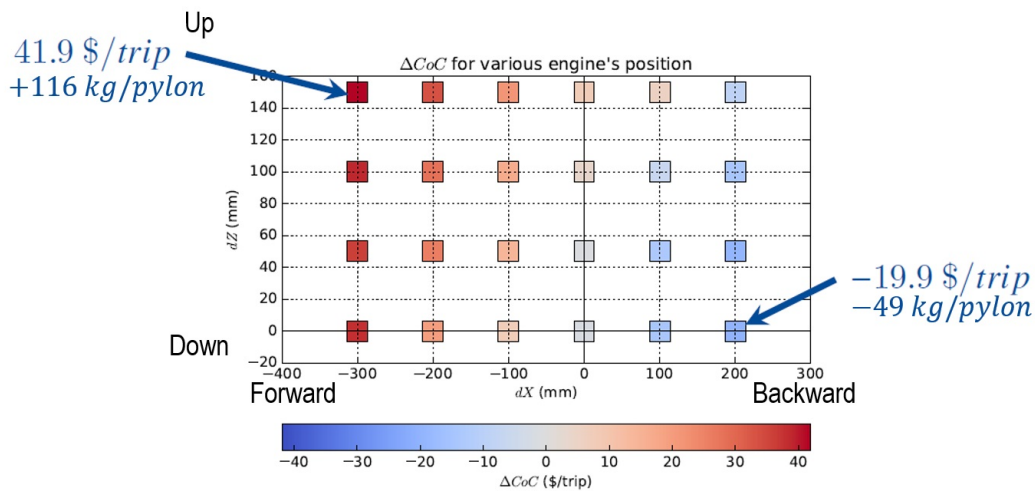

Fig. 16 ΔCOC for various engine positions

Best result is $-19.9 \text{ \$/trip}$, obtained for $dX = 200 \text{ mm}$ and $dZ = 0 \text{ mm}$. Considering X-wise engine displacement, the scatter plot figure of COC (Figure 16) shows that moving the engine forward of the wing gives the best result. On the contrary, moving the engine more ahead of the wing (dX negative) makes the pylon longer and heavier. Considering Z-wise engine displacement, moving down the engine gives the best result. When the engine is moved up (increased dZ), the pylon becomes thinner and heavier, probably because the reduction of height requires more thickness in lateral panels (to have the same stiffness).

In this trade-off, no mass evolution of secondary structure or of systems are taken into account. By bringing the

pylon closer to the wing, a reduction of these masses should improve the gain in term of mass and therefore COC.

2. Aerodynamic trade-off results

Figure 17 displays the pressure distribution on the pylon for the original XRF-1 shape, and its optimum. CFD computations were made using the elsA-ONERA software. The multipoint compromise, for this particular engine position, provided a gain of 55\$ per trip. Most of the COC gain is provided by a fuel burn decrease. The pressure plots show, by comparing 17a with 17b that the optimizer mostly affected the area where the pylon intersects the nacelle. The shape modifications smoothed the curvature changes. The pressure gradient along the longitudinal axis is reduced, which reduces viscous pressure drag. The rear part of the pylon is also affected by the shape changes, which is a consequence of the incoming flow changes. The flow around stagnation point of the wing, in the area where the pylon intersects with it, is also improved, and the very located impact on the pressure field provides a significant drag gain.

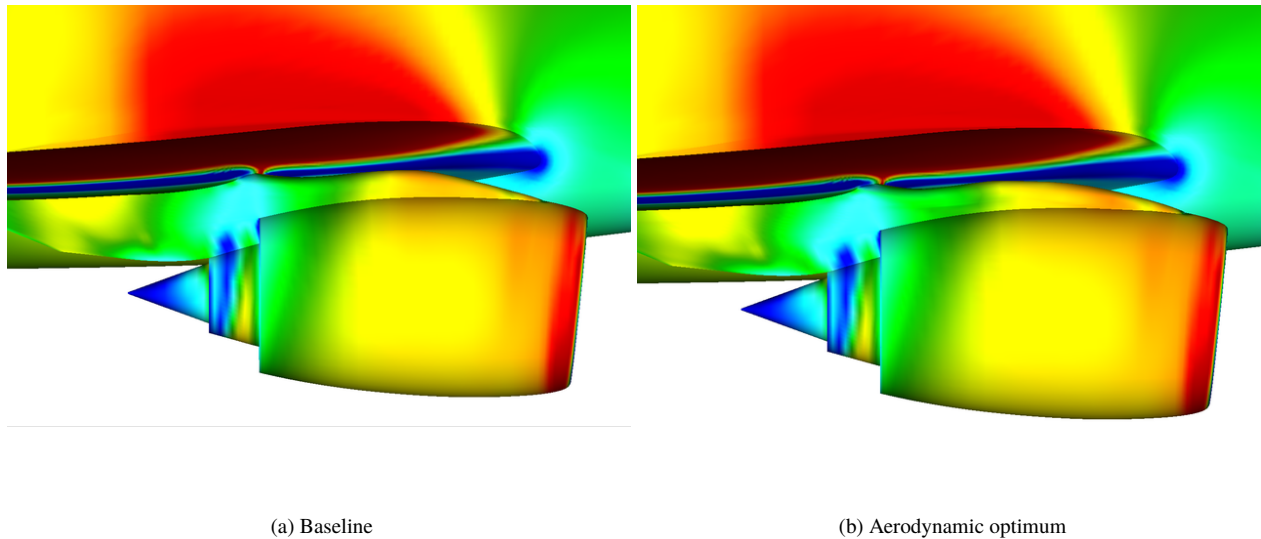

Fig. 17 Baseline and optimal shapes for minimal COC in aerodynamics, at the initial engine position ($dX=0\text{mm}$, $dZ=0\text{mm}$), $Cl=0.58$, $Mach=0.83$, $Re=4.6e7$

A second point in the tradeoff is displayed in Figure 18, by moving the engine higher and aft. This brings the engine closer to the wing, which is expected to increase the pressure gradients and the impact of the engine installation on the wing. A comparison of the pressure contours in 17a with 18a shows that the pressure gradients are amplified in the area where the pylon intersects with the nacelle, compared to the baseline configuration. The optimizer achieves similar shape modifications, displayed in 18b, and the optimal COC gain is actually better than on the baseline position ($dX=0$ and $dZ=0$) by 5\$/trip. This result is interesting because the optimizer achieved a better aerodynamic performance, for an engine position that a priori deals more issues because of a smaller engine-wing distance.

As displayed in Figure 19, the farther the engine is from the wing, the lower the pressure drag of the optimal configuration. A multipoint optimization is performed ($Cl \in \{0.5, 0.53, 0.58\}$), and the relative variations of drag with respect to the engine position are similar for all operating conditions. The friction drag increase due to the wetted area increase does not compensate for the wave and viscous pressure drag effects in the selected range of variation of the dX and dZ parameters.

Figure 20 displays the complete tradeoff results regarding the effects of aerodynamics optimization on the COC. The criteria aggregates the three operating conditions' drag into a single objective. The optimal point, for a frozen structure, is $dX=-300$, $dZ=150$. Around this optimal position, the variation of engine height is well managed by the optimizer, since all dZ positions for $dX=-300$ have close COC values. The effect of the engine position on the jet is, in the present study, not affecting the engine specific fuel consumption, while it is probably the case in reality. Adding this effect would affect the COC, and may penalize the highest values of dZ .

Figure 21 plots the pressure coefficient on this same point ($dX=-300$, $dZ=150$). It is remarkable that the optimizer achieves a consistent pressure gradient smoothing along the complete (dX , dZ) range, and in particular at the optimal

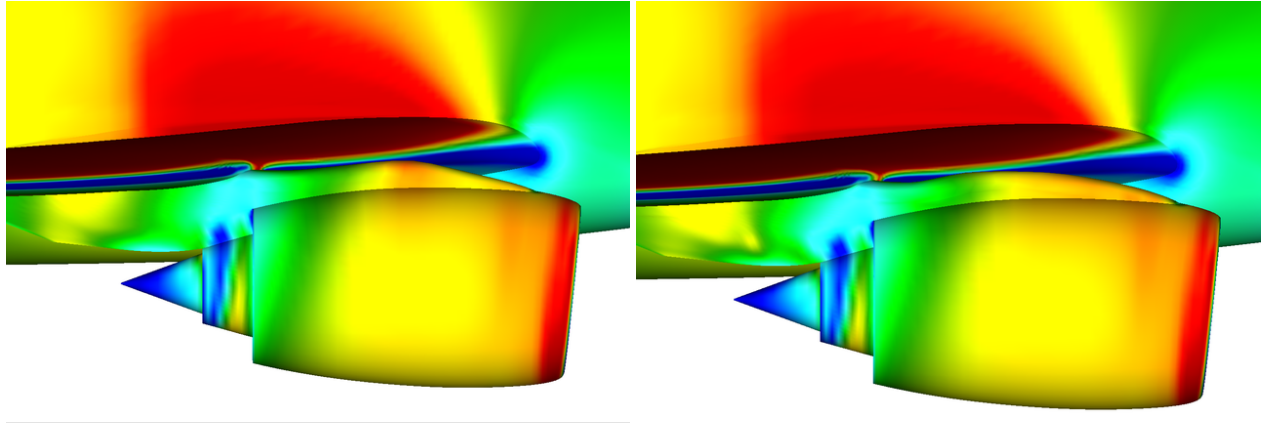

(a) Baseline

(b) Aerodynamic optimum

Fig. 18 Baseline and optimal shapes for minimal COC in aerodynamics, at the a displaced engine position ($dX=100\text{mm}$, $dZ=100\text{mm}$), $Cl=0.58$, $Mach=0.83$, $Re=4.6e7$

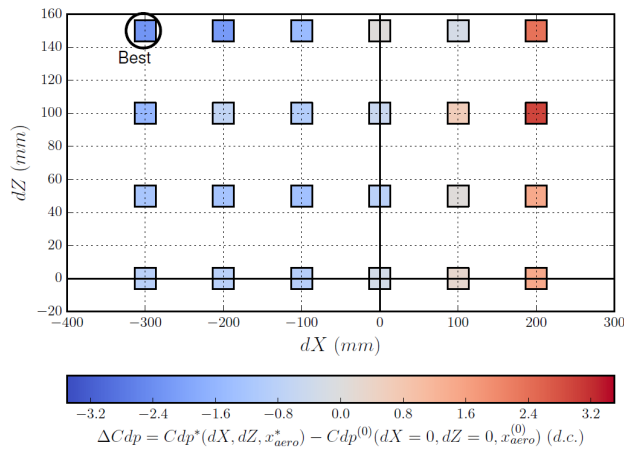

Fig. 19 Pressure drag variation at $Cl=0.58$ due to aerodynamic optimization, for varying engine positions

point when compared with the initial point. Therefore, the tradeoff comparison is not biased by an inability of the optimization process to reduce the drag of some configuration, or its ability to take advantage of a numerical bias or a problem setting issue.

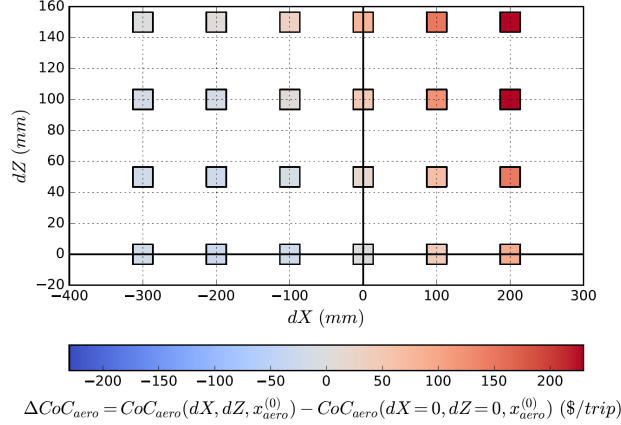

Fig. 20 COC variation due to drag variation for varying engine positions

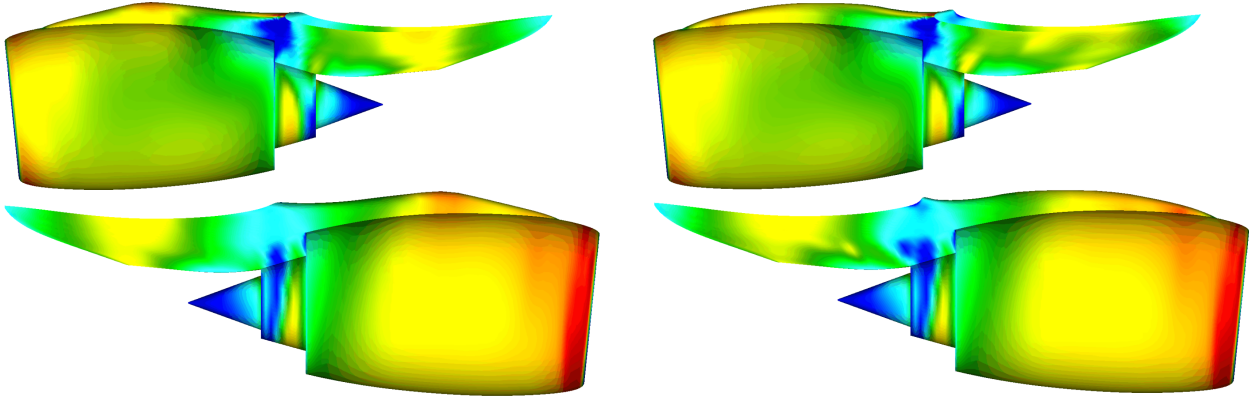

Fig. 21 Pressure coefficient of the starting point of the aerodynamic optimization (left) and optimal configuration (right) at the best engine position ($dX=-300$, $dZ=150$) from an aerodynamics point of view

3. Pylon aero-structure trade-off results

First, the multidisciplinary parametrization has succeeded in ensuring the disciplinary consistency: the structural optimum shape stays inside the aerodynamic optimum shape whatever the considered engine displacement. Figure 22 displays the optimal external shape for aerodynamics (in blue) and the optimal structural shape of the pylon (in green) for a position where the engine is closer to the wing: $dX=100$ mm, $dZ=100$ mm.

Figure 23 compares the COC gain for $dX \in [-300\text{mm}, +200\text{mm}]$ and $dZ \in [0, +150\text{mm}]$. The best configurations are located in the area $dX \in [-300\text{mm}, -100\text{mm}]$ and $dZ \in [40\text{mm}, 60\text{mm}]$, for which the gain in COC reaches -90 \$ / trip.

When comparing with best configurations coming from single aerodynamic optimization and single structure optimization:

- The point $dX = +200$ mm, $dZ = 0$ mm, provides the maximum COC gain from structure that is -19.9 \$/trip,
 - The point $dX = -300$ mm, $dZ = 150$ mm, provides the maximum COC gain from aerodynamics that is -140 \$/trip
- it is clear that the aero-structural best configuration is a compromise between both disciplines, the structure discipline trying to move the engine closer to the wing in the X direction while the aerodynamic discipline tries to move the engine away from it in order to reduce the wing-engine interactions. In addition, best configurations correspond to a large area, what shows the robustness of the solution, robustness that is a main industrial requirement.

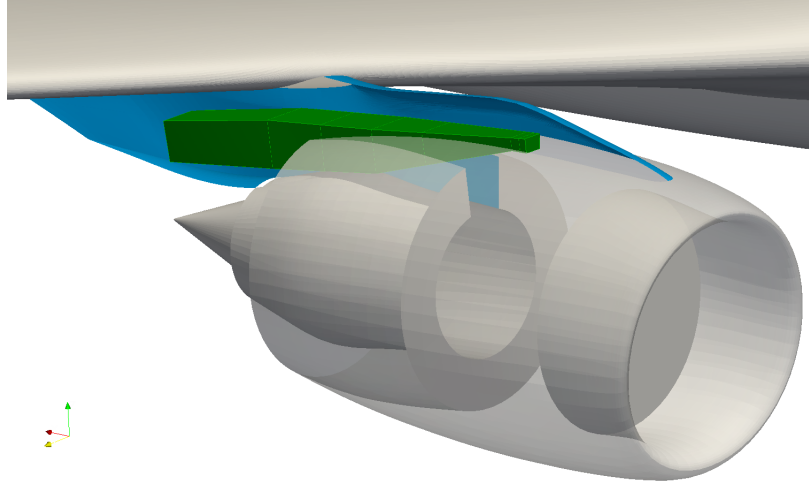

Fig. 22 Aero-structure integrated geometry

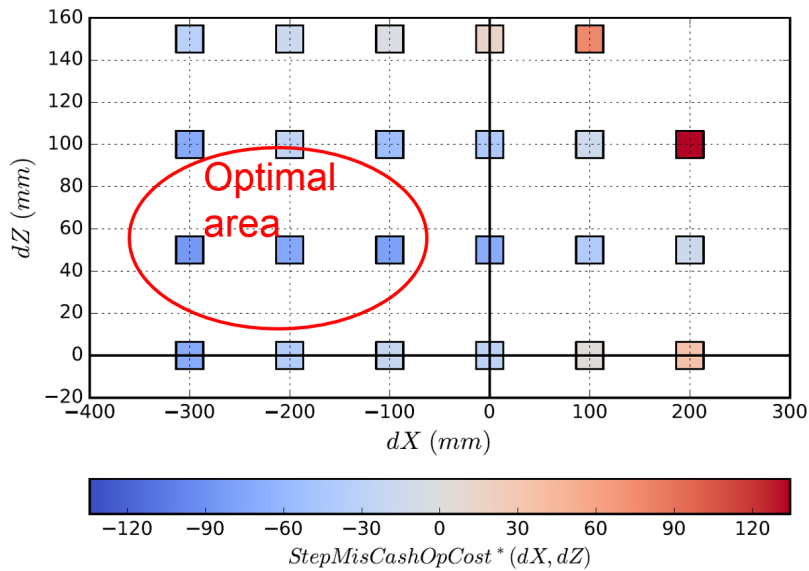

Fig. 23 COC trade-off results for (X, Z) engine displacement, X negative = forward, Z positive = upward

4. Pylon aero-structure optimization results

Replacing the DoE scenario with a true MDO scenario thanks to the ease of use provided by GEMS, it is then straightforward to perform a bi-level formulation based aero-structure optimization:

- the derivative free constrained optimization by linear approximation algorithm (COBYLA) is used at the system level to determine the optimum values of dX, dZ and of ΔCOC ,
- for each new value of (dX, dZ), the process described on Figure 11 is applied.

Figure 24 shows the history convergence of the algorithm towards the optimum in terms of number of iterations (on the left) and in terms of (dX, dZ) engine displacement. Again, it appears that the MDO optimum is robust with respect to the engine displacement.

The best MDO point is:

- $dX = -254\text{mm}$, $dZ = 43\text{mm}$, for a value of COC gain = $-90\$/\text{trip}$,
- what corresponds to a fuel block gain of 110 kg, a drag gain of 1 dc and a pylon mass increase of 70 kg.

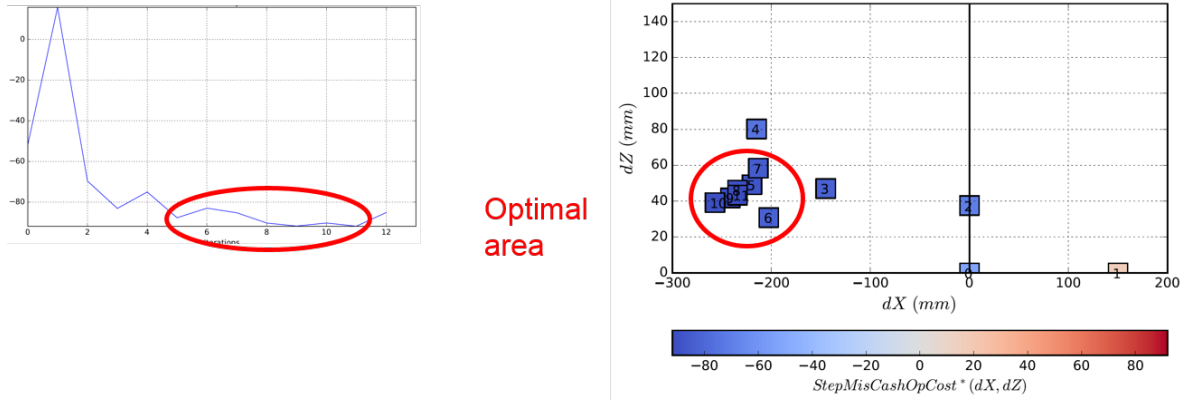

Fig. 24 Aero-structure optimization convergence history; on the left: in terms of iterations; on the right: in terms of (dX, dZ) engine displacement.

Figure 25 shows the evolution of the dX and dZ design variables (on the left) and the evolution of the inequality constraints (on the right) during iterations.

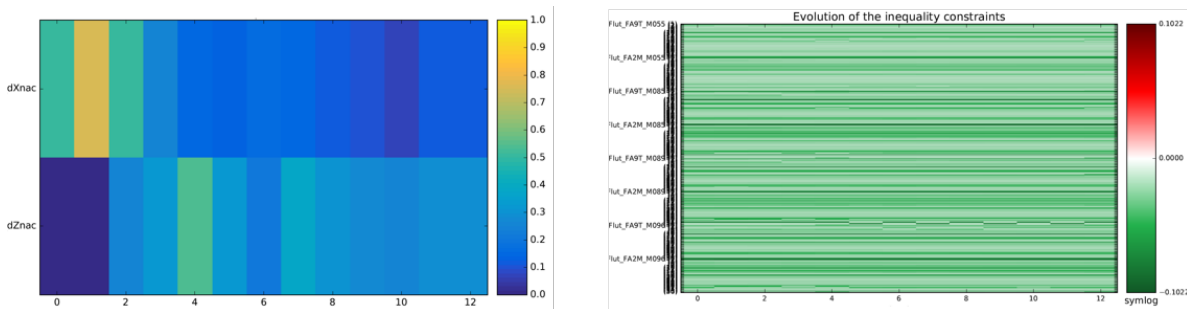

Fig. 25 Evolution of the dX and dZ design variables (on the left) and the evolution of the inequality constraints (on the right) during iterations.

Following paragraphs analyze this MDO optimum point from aerodynamics, structure and mission profile points of view. Finally the performance of these processes is presented.

Aerodynamic analysis of the MDO optimum

Figure 26 and Figure 27 displays the pressure coefficients on the baseline configuration versus the MDO optimum. The same comments on the shape and flow modifications as in subsection IV.C.2 can be made. The key areas of the flow are well handled and the final solution shows smooth pressure gradients on the complete pylon. Consistent aerodynamic shape modifications observed during the MDO convergence as well as at the MDO optimum.

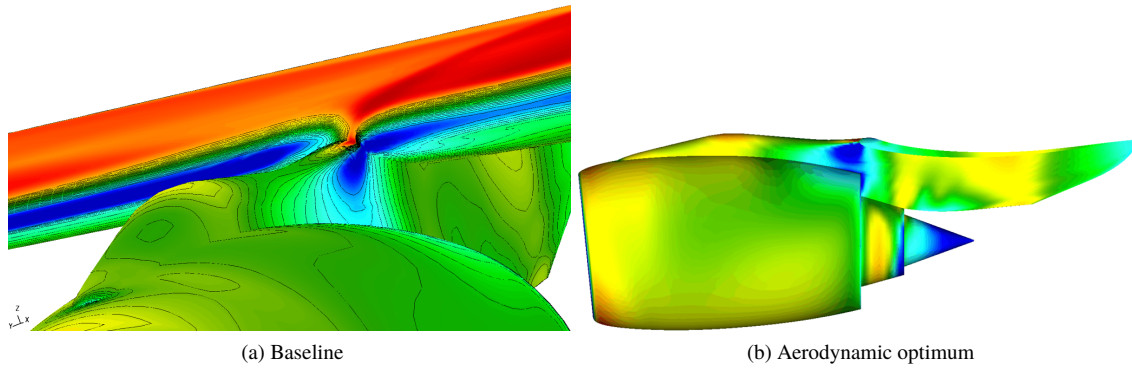

Fig. 26 Baseline geometry, pressure coefficient at Mach 0.83, Cl 0.58

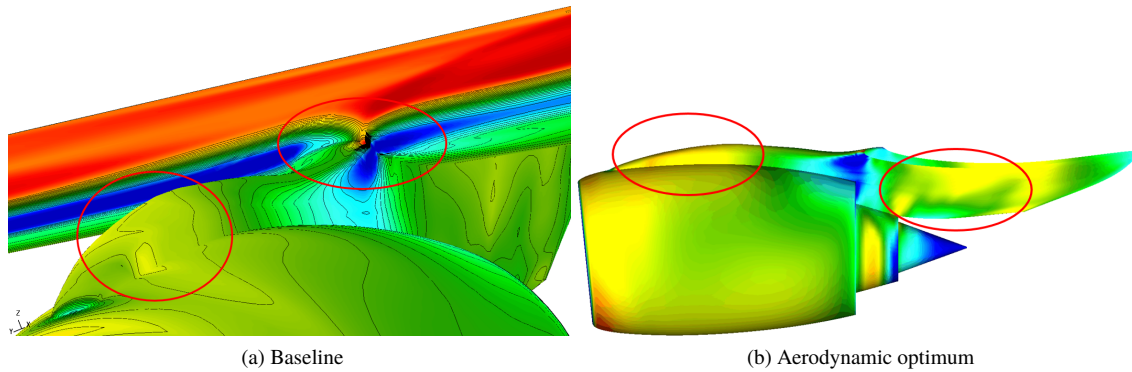

Fig. 27 MDO optimum, pressure coefficient at Mach 0.83, Cl 0.58, the area of interest are highlighted

Structure analysis of the MDO optimum

Optimal results are physically explainable and consistent across the MDO history:

- Figure 28 displays that thicknesses increase close to the rear engine mount and the front wing mount what is a classical behaviour in pylon sizing;
- Figure 29 displays that specific ultimate loads are critical on the rear lateral panels, and that fatigue cases are critical for corners;
- The rest of the pylon is minimum thickness or sized by the displacement constraint;
- Finally, the mass is fully converges (see Figure 30).

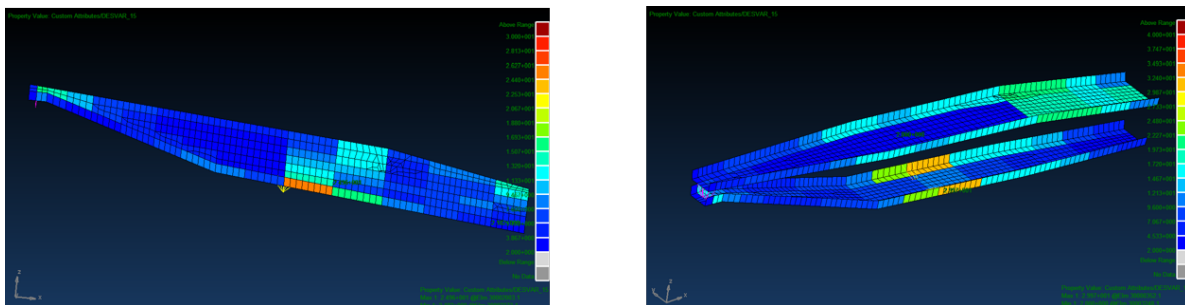

Fig. 28 Panel's thicknesses at MDO optimum.

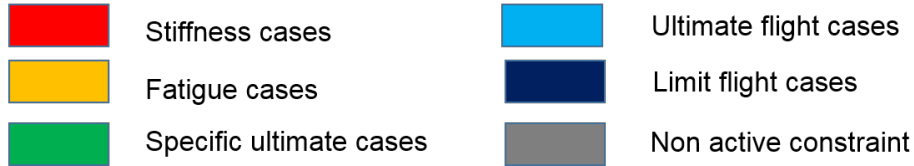
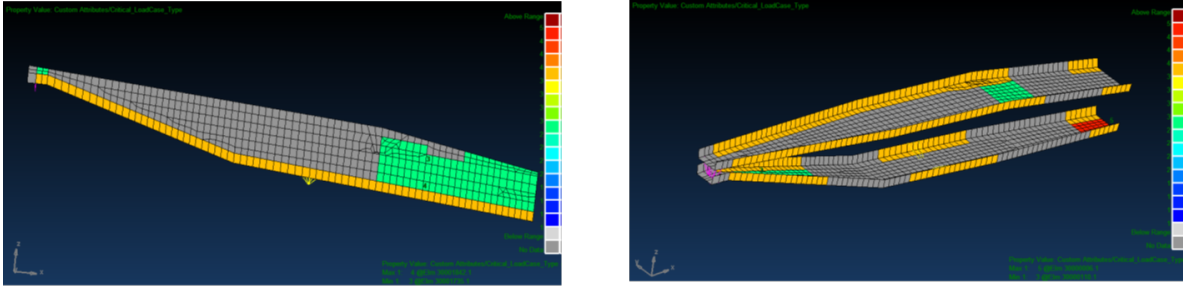

Fig. 29 Critical loads per zone at MDO optimum.

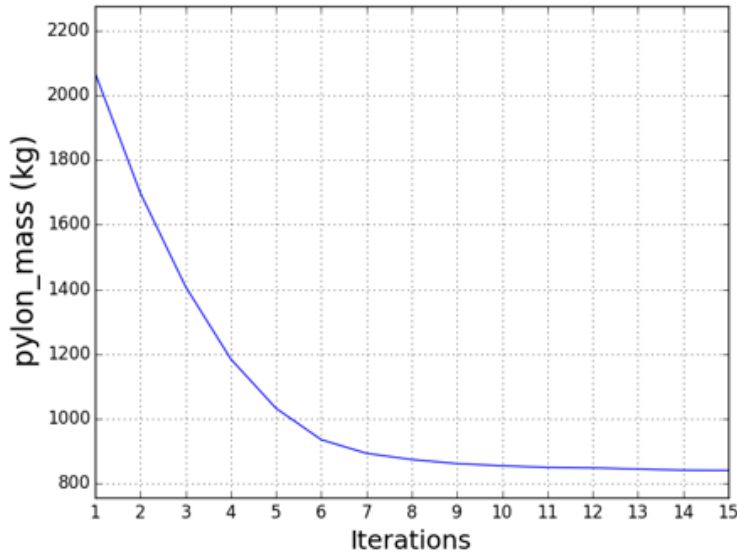

Fig. 30 Mass convergence at MDO optimum.

Analysis of the optimal mission profile

Considering the computation of the COC, it must be mentioned that the mission profile itself is optimized to maximize the specific air range (i.e. the distance that can be flown per unit of fuel mass). This can be observed on Figure 31 where the vertical flight profiles of the starting pylon design point and the optimum point are superimposed. The position of the level change has moved earlier showing that the mission optimizer has taken benefit of the change in drag and weight. This is a small change but it stands for a more general behavior which is the reaction of a theoretical airline to a modification of the airplane performances. Indeed, if the airplane polar shape evolves, mission profile optimization will tend to take most important benefit of this evolution which may have the effect to increase the impact of modifications that are likely to bring the most important operational benefit. In this case, operational strategies are leading the design through the COC. Of course these considerations take all their sense if COC, or any other integrative criterion, is evaluated on the basis of a set of missions or even more a typical route network as in [15] and [16].

Figure 32 illustrates the coupling that are managed by the OAD module. Two OAD disciplines (mission simulation and structural mass estimation) are coupled via three variables (Fuel, MWE and MTOW). The input data pylon mass

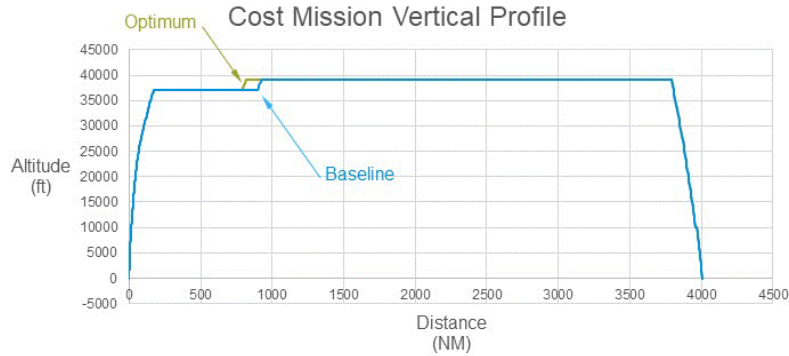

Fig. 31 Evolution of mission vertical profile.

and drag polar are modifying the equilibrium between MWE, Fuel and MTOW. The figures in the variables frames are giving the variations between the initial point and the final point of the optimization process. The Mass-Mission

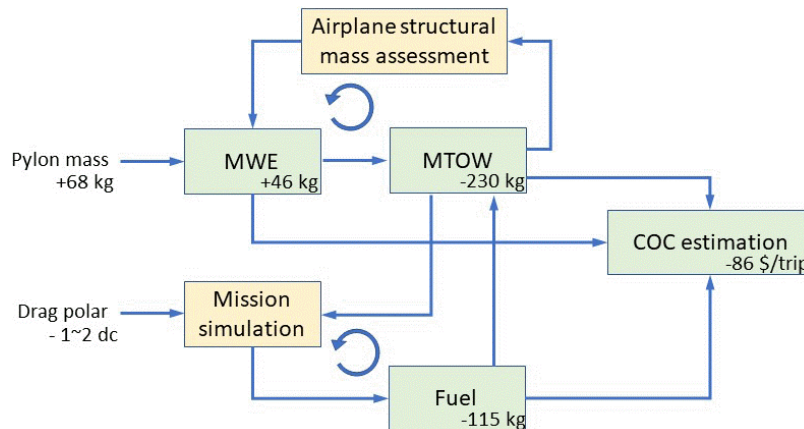

Fig. 32 OAD mass coupling and final evolutions.

adaptation process managed by the OAD module satisfies the couplings whatever the input in term of pylon mass and drag polar. It appears that the decrease of the drag by about 1 to 2 dc (depending on the CL) had the effect to decrease the amount of fuel required to fly the nominal mission which results in a global decrease of 230kg of the MTOW. Decrease of MTOW has the effect to damp to 42kg the initial increase of the MWE by 68kg due to the pylon. Combined effect on MWE and drag has the consequence to save 115kg of fuel on the cost evaluation mission. Finally, variations of MWE, MTOW and Fuel are combined into COC evaluation to produce a global saving of about 86\$ per trip (here : 4000NM).

In the context of this study, both fuel saving and MTOW reduction have been converted into cost reduction but potential MTOW reduction could as well be converted into revenue as soon as a suitable evaluation of the benefit of extra range is available. Both MTOW reduction or extra range can be interesting for airlines. In this study, Mass-Mission adaptation and COC criterion allow to give a more realistic value to the global benefit by setting the exchange rate between mass and drag from an airline point of view.

Performance of trade-off and MDO processes

The described study case is fully representative of an industrial application: it involves 840 bounded design variables (structure and aerodynamic disciplinary design variables, plus the engine position variables) and 200 000 non-linear constraints.

The trade-off study:

- required 1300 CFD computations,
- generated 10 TeraBytes in 10 millions files,

- has been achieved in 210 000 CPU hours, 14 days (wait time) on 780 CPUs.

The MDO study:

- required 150 CFD computations on 142 CPU; 12 CPUs were used for the structure,
- has been fully converged in 20 000 CPU hours, 6 days (wait time) on 144 CPUs;
- A "fast" optimum, distant of 5\$/trip from the true converged optimum, can be obtained in 4 system-level iterations achieved in 24 hours on 470 CPUs, the first three iterations of the COBYLA optimizer being parallel (a deterministic design of experiment).

Conclusion

The main achievements of the MDA-MDO project have been presented and demonstrated on a pylon aero-structure-OAD trade-off and optimization study fully representative of industrial constraints in terms of simulation models and software heterogeneity.

They consist in:

- a generic Bi-level MDO formulation that facilitates the transformation of a trade-off process into a true MDO one, since the change is limited to using an optimization algorithm instead of a Design of Experiment one;
- a MDO platform capable of full automatic creation and execution of processes based on MDO formulations, using industrial simulation and optimization tools deployed on HPCs, along with state of the art algorithms;
- and finally in physically understandable results provided by multi-fidelity trade-off and MDO processes demonstrating that, as expected, the MDO optimum is a compromise between aerodynamics, loads, structural sizing and mission performance.

One main challenge posed by industrial MDO is to have all ingredients addressed together in a consistent manner. The MDO platform must integrate the MDO methodologies, that must be appropriate to solve the optimization problems, which mathematical properties arise from the physical models, which have to be fully parametric, automated, and interfaced with the platform. The MDO platform described in III integrates all required capabilities hence provides a multidisciplinary designer with a tool of high added-value enabling a deep and efficient design space exploration and the identification of a robust multidisciplinary optimum solution.

A second challenge is to obtain MDO results within an acceptable total CPU time, and, more importantly, a return time compatible with human design cycles. If the choice of using the bi-level formulation was clearly led by the requirement in terms of process flexibility, the expected performance of such formulation was *a priori* at risk. Indeed, multi-level formulations are often mentioned as not as efficient as monolithic formulations such as the MDF and IDF formulations. In particular, a comparison of MDO formulations has been performed on the Sellar problem in [17] where it appears that the BLISS formulation requires much more discipline evaluations so is much more expensive than the MDF or IDF formulation. But the efficiency of a MDO formulation highly depends on the numerical ingredients it contains, in particular on the optimization algorithms that are used, and on specific numerical techniques such as preconditioners or warm starts. Besides, the presently used bi-level formulation is significantly different from the original BLISS formulation. The research effort put on these numerical ingredients allowed to go beyond the state-of-the-art and led to achieve a full converged MDO in 6 days, and a consistent MDO solution in 1 day on 470 CPUs. Such a return time is compatible with an industrial usage.

All things considered, this bi-level formulation, that intrinsically offers very interesting flexibility properties, also demonstrates good efficiency possibilities, and is finally well-suited to meet the industrial challenges.

The results of this pylon MDO study case prove that the different methods and capabilities developed in the MDA-MDO project have reached a level of maturity sufficient to deal with industrial design challenges.

Acknowledgments

The authors wish to acknowledge the PIA framework (CGI, ANR) and the industrial members of the project Airbus, Altran Technologies, Capgemini DEMS France and CERFACS for their support, financial funding and own knowledge.

The studies presented in this article is making use of the elsA-ONERA software, whose the co-owners are Airbus, Safran, and ONERA.

References

- [1] Ciampa, P. D., and Nagel, B., "Towards the 3rd generation MDO collaborative environment," ICAS, 2016.

- [2] Gazaix, A., Gallard, F., Gachelin, V., Druot, T., Grihon, S., Ambert, V., Guénot, D., Lafage, R., Vanaret, C., Pauwels, B., et al., "Towards the industrialization of new mdo methodologies and tools for aircraft design," *18th AIAA/ISSMO Multidisciplinary Analysis and Optimization Conference*, 2017, p. 3149.
- [3] Martins, J. R. R. A., and Lambe, A. B., "Multidisciplinary Design Optimization: A Survey of Architectures," *AIAA Journal*, Vol. 51, No. 9, 2013, pp. 2049–2075. doi:10.2514/1.J051895.
- [4] Sobieszczanski-Sobieski, J., Agte, J. S., and Jr., R. R. S., "Bi-Level Integrated System Synthesis (BLISS)," Tech. Rep. TM-1998-208715, NASA, Langley Research Center, 1998.
- [5] Gallard, F., "Optimisation de forme d'un avion pour sa performance sur une mission," Ph.D. thesis, École Doctorale Aéronautique-Astronautique (Toulouse); 142618039, 2014.
- [6] Gallard, F., Vanaret, C., Guénot, D., Gachelin, V., Lafage, R., Pauwels, B., Barjhoux, P.-J., and Gazaix, A., "GEMS: A Python Library for Automation of Multidisciplinary Design Optimization Process Generation," *2018 AIAA/ASCE/AHS/ASC Structures, Structural Dynamics, and Materials Conference*, 2018, p. 0657.
- [7] Phoenix Integration, "ModelCenter 9.0 User's Manual," , 2009.
- [8] Meaux, M., Cormery, M., and Voizard, G., "Viscous aerodynamic shape optimization based on the discrete adjoint state for 3d industrial configurations," *4th European Congress on Computational Methods in Applied Sciences and Engineering (ECCOMAS)*, Jyväskylä, Finland, July, 2004, pp. 24–28.
- [9] Cambier, L., Heib, S., and Plot, S., "The Onera elsA CFD software: input from research and feedback from industry," *Mechanics & Industry*, Vol. 14, No. 3, 2013, pp. 159–174.
- [10] Grihon, S., and Malherbe, G., "A rapid sizing tool for airframe conceptual design studies," *LMS European Aeronautical Conference, Toulouse*, 2012.
- [11] Grihon, S., "Structure Sizing Optimization Capabilities at AIRBUS," *Proceedings of the 12th World Congress of Structural and Multidisciplinary Optimisation (WCSMO12)*, pp 719-737, 2017.
- [12] Guénot, D., Gallard, F., Brézillon, J., and Mérillac, Y., "Aerodynamic optimization of a parametrized pylon engine on a mission path using adjoint method," *6th European Conference on Computational Mechanics*, 2018.
- [13] Dabas, B., Lefebvre, T., Bartoli, N., Gallard, F., Gazaix, A., Druot, T., and Guénot, D., "Error-based adaptive coupling process between multipoint high-fidelity aerodynamics and mission performance for shape optimization in the MDA-MDO Project." *2019 AIAA AVIATION Forum*, 2019.
- [14] Gallard, F., Mohammadi, B., Montagnac, M., and Meaux, M., "An adaptive multipoint formulation for robust parametric optimization," *Journal of Optimization Theory and Applications*, Vol. 167, No. 2, 2015, pp. 693–715.
- [15] Liem, R., Kenway, G., and Martins, J., "Multimission Aircraft Fuel-Burn Minimization via Multipoint Aerostructural Optimization," *AIAA Journal* 2014. Doi:10.2514/J052940, 2014.
- [16] Hwang, J., and Martins, J., "Allocation-mission-design optimization of next-generation aircraft using a parallel computational framework," *AIAA.ASCE.AHS.ASC Structures, Structural Dynamics, and Materials Conference*, 57, 2016, San Diego, California, pp 1662, 2016.
- [17] Gray, J., Moore, K. T., Hearn, T. A., and Naylor, B. A., "Standard platform for benchmarking multidisciplinary design analysis and optimization architectures," *AIAA journal*, Vol. 51, No. 10, 2013, pp. 2380–2394.