



HAL
open science

A design modification of a quadrotor frame based on fused deposition modeling

A. Jimenez-Flores, P.A. Tellez-Belkotosky, E Javier Ollervides-Vazquez, Pedro Castillo Garcia, L.A. Reyes-Osorio, Octavio Garcia-Salazar

► **To cite this version:**

A. Jimenez-Flores, P.A. Tellez-Belkotosky, E Javier Ollervides-Vazquez, Pedro Castillo Garcia, L.A. Reyes-Osorio, et al.. A design modification of a quadrotor frame based on fused deposition modeling. International Conference on Unmanned Aircraft Systems (ICUAS 2024), Jun 2024, Chania, Greece. pp.800-806, 10.1109/ICUAS60882.2024.10556885 . hal-04794767

HAL Id: hal-04794767

<https://cnrs.hal.science/hal-04794767v1>

Submitted on 21 Nov 2024

HAL is a multi-disciplinary open access archive for the deposit and dissemination of scientific research documents, whether they are published or not. The documents may come from teaching and research institutions in France or abroad, or from public or private research centers.

L'archive ouverte pluridisciplinaire **HAL**, est destinée au dépôt et à la diffusion de documents scientifiques de niveau recherche, publiés ou non, émanant des établissements d'enseignement et de recherche français ou étrangers, des laboratoires publics ou privés.

A design modification of a quadrotor frame based on fused deposition modeling

A. Jimenez-Flores¹, P.A. Tellez-Belkotosky¹, E.J. Ollervides-Vazquez^{1,2},
P. Castillo³, L.A. Reyes-Osorio¹ and O. Garcia-Salazar¹

Abstract—Quadrotor UAVs have mass variations in their performance and cost, or these are made of materials such as carbon fiber, which implies a higher manufacturing cost. Therefore, an alternative is to resort to manufacturing parts using 3D printing to reduce the mass and improve strength of materials. This work focuses on the structural analysis of a quadrotor UAV previously manufactured using 3D printing technology with polylactic acid (PLA) filament as an alternative to higher cost materials. Buckling problems are presented in the original design of the frame, so its design is reinforced by considerably increasing the mass. The main objective is to reduce the mass without compromising the structural integrity. Experimental tensile tests are performed on PLA specimens to determine their mechanical properties, as well as rotor thrust tests to evaluate the maximum loads on the frame. Three frame alternatives are proposed and designed, with the second proposal being the most successful, with a 41% reduction in mass. The structural simulation shows that this proposal complies with the structural limits of the aircraft, highlighting the feasibility of using PLA and optimizing designs using the finite element technique to reduce mass without compromising strength, representing an economical and efficient option in terms of aeronautical engineering.

I. INTRODUCTION

In recent decades, quadrotor unmanned aerial vehicles (UAVs) have been widely used in different applications, demonstrating their capabilities to work in a wide range of fields. Likewise, researchers have proposed challenges that have been met; two of the biggest challenges that continue to present in these aircraft are the overall weight and battery endurance, which are the challenges that can solve each other to solve the problem of the battery. The solution is to reduce the weight of the quadrotor frame using other types of materials and manufacturing techniques, among which there is the additive manufacturing technique using materials such as polylactic acid (PLA), carbon fiber fragments combined with polylactic acid (CF+PLA), acrylonitrile butadiene styrene (ABS), among other materials that offer different properties. Another factor influencing weight reduction is the optimized frame design. In [1], a preliminary design of the quadrotor arm was proposed where the mechanical characteristics of the Acrylonitrile Butadiene Styrene (ABS)

material consumption grade by fused filament fabrication (FFF) are considered. An interactive design process was followed to reduce the mass and improve the mechanical properties, performing evaluations by finite element analysis. The first two designs showed competent results through static analysis, leading to a third design. After the third design and its results, a fourth design was proposed, which improved the results considerably. The fourth proposed design for the four quadrotor arms has an estimated mass of 107.13 (*g*) for each arm. All designs showed stresses within the material mechanical strength in the static analysis but not in the drop tests. In the last two designs, the modal frequencies are within the range of the rotational frequency of the motors.

In [2], the FFF method was used to fabricate a unified body of quadrotor UAV frames to reduce assembly time. Four frame designs were presented for the quadrotor UAV, where each design reduced the weight of the previous one by adding grooves in order to increase the strength-to-weight ratio. On the other hand, the purpose of this quadrotor UAV was to collect algae in residual waters through the help of floats to be floating in the water and a manipulator arm to collect the algae. System integrity analyses were performed considering assembly time, static structural, energy consumption, and weight. In [3], a Python package was used to generate mechanical elements through scripts, where the principles of hierarchical structure and modular reuse were considered to simplify the design process. The origami method was used to design the quadrotor frame by folding precisely cut plastic sheets. Using this process led to the designing and manufacturing of lightweight, low-cost, and fast-to-build quadrotor UAVs. Comparisons were carried out against a commercial quadrotor UAV, where the results obtained show that those manufactured through lamination present less tolerance and precision. At the same time, their manufacturing process was much less than that of a conventional quadrotor UAV.

In [4], the design of a quadrotor UAV frame, composed of four pieces, was carried out. It was printed using the FFF technique using ABS combined with polycarbonate (ABS-PC) and carbon fiberglass. The quadrotor UAV frame design was submitted to finite element analysis, such as static structural, impact analysis, and modal analysis, and a factor of safety of 2.5 was obtained during the finite element analysis. The safety factor was achieved by considering the speed of the motors in each arm, where the quadrotor UAV frame started to deform at 416 (*Hz*), and the distance of 7.62 (*m*) for the impact tests. In [5], A computational fluid dynamic (CFD) and transient structural analysis were

¹Aerospace Engineering Research and Innovation Center, Faculty of Mechanical and Electrical Engineering, Autonomous University of Nuevo Leon, Apodaca NL, Mexico. alejandro.jimenezf@uanl.edu.mx; pablo.tellezb@uanl.edu.mx; eduardo.ollervidesv@uanl.edu.mx; luis.reyessr@uanl.edu.mx; octavio.garciasl@uanl.edu.mx

²La Laguna Institute of Technology-TecNM, Torreon Coahuila, Mexico. ejollervidesv@lalaguna.tecnm.mx

³Heudiasyc Laboratory CNRS UMR 7253, Université de Technologie de Compiègne, Compiègne France. castillo@hds.utc.fr

performed on the propellers of a quadrotor UAV to determine their thrust and the induced deformation and stress. The propeller was designed using CAD software. With the fluid analysis, it was possible to observe the behavior of the air in the quadrotor UAV as well as in the propeller. The values of the thrust forces at different angular velocities could be obtained to know the propeller's thrust coefficient.

In [6], five different frames of quadrotor UAVs were built, modeled, and computationally analyzed using three composite materials: glass fiber reinforced polymer (GFRP), carbon fiber reinforced polymer (CFRP), Kevlar fiber reinforced polymer (KFRP) and a conventional material: Aluminum Alloy. The critical factors for their selection were to optimize low-stress induction, lower deformation, and high service life. In [7], design optimizations were achieved for quadrotor, hexarotor, and octocopter UAVs. Optimal designs were obtained for two cases: one to optimize the quadrotor UAV dynamics with a given payload and flight time and the other to optimize the flight time. The results showed that the best dynamics performance was achieved with the quadrotor UAV, while the hexarotor UAV achieved the longest flight time. In [8], a design optimization of a quadrotor UAV was achieved using 3D printing technology. Two approaches were used to design a customized quadrotor UAV frame, a hybrid frame developed using carbon fiber tubes and 3D printed parts, and a fully 3D printed frame. The two approaches were compared, highlighting weight and efficiency parameters. In [9], a generative design tool was used in the Fusion 360 software from Autodesk to generate the frame for a quadrotor UAV. Static stress-strain simulations were performed, and the modal frequency and displacement results of the quadrotor UAV manufactured by additive technique were compared with a DJI F450 frame. Through the generative design technique, the frame presented a minimum displacement compared to a traditionally designed frame. It was observed that the generative design makes designs that present excellent resistance to fracture and displacement since, as a user, one determines the desired load to support in the frame.

In [10], a design topology optimization was performed to design a frame and its fabrication using the additive manufacturing technique. The frame was redesigned as a monocoque structure according to the desired results in decreasing the quadrotor UAV weight and assembly time. The results of modal analysis, computational fluid dynamics, and wind tunnel tests proved to be within the allowed ranges. In contrast, it proved better in assembly times and field tests than the commercial ones. In [11], the design of a quadrotor UAV was performed, which was optimized in two stages; in the first stage, they analyzed different ways of designing the quadrotor frame to maintain a minimum mass, while in the second stage, the topology was optimized in order to reduce the mass of the frame already optimized in the first stage. The resulting model presented a difficulty for fabrication; then, the quadrotor UAV frame was redesigned and validated through a static finite element structural analysis.

Although multiple structural simulations have been carried out regarding quadrotor UAV frames, the question remains

whether the mechanical properties of the material match the actual application of the constructed frame. Moreover, the actual loads applied on the quadrotor UAV frame must be analyzed for accurate structural simulations. In this work, a constructed quadrotor is considered, and the primary purpose is to minimize the mass of its frame without compromising its structural resistance. The frame is manufactured using fused deposition modeling (FDM) techniques. The designs of different quadrotor UAV frames subjected to structural simulations are presented. For this, tensile tests are performed on the quadrotor UAV frame material and thrust tests on its rotor propellers, which are performed in order to obtain the mechanical properties of the material and the thrust data, respectively. Once obtained, the simulations are conducted, and the results are accurate in real-life environments.

The remaining of the paper is divided as follows. In Section II, the preliminary tests are presented. The quadrotor UAV frame is designed, showing the proposed designs in Section III. The results in each proposed frame are shown in Section IV, and some conclusions and proposals are described in Section V.

II. PRELIMINARY WORK

The quadrotor UAV presented in this work has an "X" configuration whose frame is manufactured employing 3D printing techniques using PLA as material with an infill density of 100%. The original frame is created in a single print; nevertheless, it shows inordinately high buckling on its arms, which is why some reinforcements are printed and applied to the original frame, resulting in the reinforced frame (Figure 1). The quadrotor UAV is subjected to force and torque tests using an aluminum base with a miniature force-torque sensor mounted on it, as shown in Figure 2. The force and torque tests are executed to measure force and torque magnitudes exerted by the quadrotor and to observe the structural behavior of the quadrotor frame. The tests are successfully executed yielding positive outcomes, revealing no buckling on the quadrotor frame. Nonetheless, the weight of the quadrotor UAV still remains considerably high, which is the topic to be discussed in this work. The electronic devices selected in order to operate the quadrotor UAV are mentioned in the appendix section.



Fig. 1: The current quadrotor with reinforced frame



Fig. 2: The quadrotor under force-torque tests

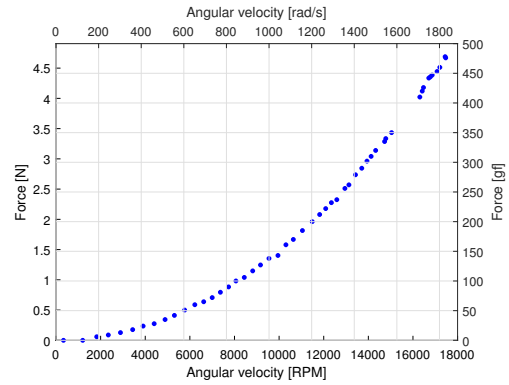

Fig. 4: Propeller force data

A. Propeller Thrust

In order to analyze the thrust forces generated by the motor propeller, several thrust tests are carried out with the support of a propeller thrust tester (see Figure 3), whose characteristics are shown in Table V from the Appendix. Also, a tachometer (see Figure 13 in Appendix) is used to measure the rotor RPMs along the propeller thrust tests. The main objective of these tests is to relate the motor rotation speed with its thrust force and to know the highest thrust force value generated by the propeller.

The results of the propeller thrust tests are graphically presented in Figure 4. Note that the maximum force values generated by the propeller are around 4.5 (N) at an angular velocity of 1800 (rad/s).

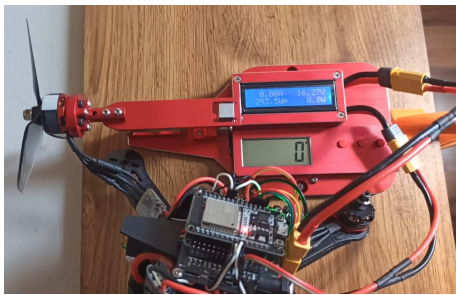

Fig. 3: Propeller thrust tests

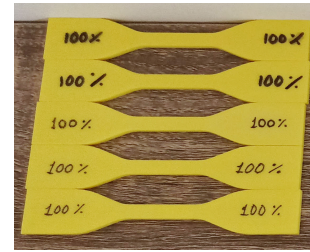
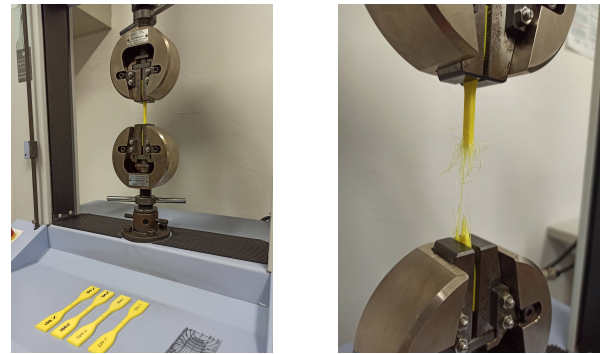

Fig. 5: PLA 3D printed specimens



(a) Specimen under tension (b) Specimen after test

Fig. 6: PLA tensile tests

B. PLA Tensile Tests

Since the quadrotor UAV frame is manufactured on PLA, the mechanical properties of this material have to be studied in order to carry out the numerical simulations. For this reason, five PLA specimens are 3D printed at 100% infill density (the same as the quadrotor UAV frame). The PLA specimens are subjected to tensile tests in order to find the PLA stress-strain curve and consequently its mechanical properties. Figures 5 and 6 show the 3D printed specimens and their tensile tests, respectively. Therefore, five stress-strain curves are obtained, and the average of these is

presented in Figure 7. Thanks to the stress-strain curve, the mechanical properties of PLA are determined (see Table I).

III. QUADROTOR UAV FRAME DESIGN

The original frame (Figure 8a) and the reinforced frame (Figure 8b) are designs that have a printed version; the proposed ones are numerated from 1 to 3, and each design is intended to reduce the mass and improve resistance to deformation. The first proposed frame (Figure 8c) has hollows in each arm but increases the height. The second proposed frame (Figure 8d) added a grid configuration to reinforce the hollow zones as well as increase the arms height, and the third proposed frame (Figure 8e) has an armored configuration instead of a grid configuration, intending to reduce

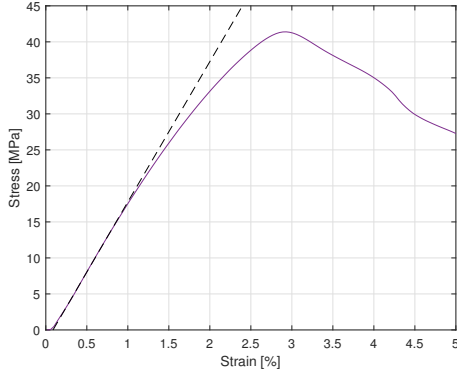

Fig. 7: Stress-strain curve of PLA

TABLE I: PLA mechanical properties obtained by tensile tests

	Infill density
	100%
Elastic Modulus (E) (GPa)	1.94
Ultimate Tensile Strength (UTS) (MPa)	41.38
Yield Strength (MPa)	16.02

the maximum deformation of each arm and minimizing the frame mass at its most compared to the other designs.

The mass of each frame and the mass reduction percentage with respect to the mass of the reinforced frame are shown in Table II since the mass of the current frame is needed to be reduced. Note that from Proposal 1 to Proposal 3, there is a tendency to minimize the mass.

All the presented frames are subjected to finite element analysis in order to determine their maximum deformations and stresses when the static loads (propeller forces) are acting on the frames. The zones of supports and forces applied on the quadrotor UAV frame are shown in Figure 9. Note that the supports are located in the center of the frame since it is the section that contains the majority of the quadrotor UAV components. At the same time, the forces are applied at the ends of the frame arms where the motors are located and generate the thrust forces by the propellers. The magnitude of each force applied is equal to 4.5 (N) since it is approximately the maximum value obtained from the propellers in the propeller thrust tests. The zones of supports and forces are equally applied to all the frames.

TABLE II: Frame mass relation between reinforced frame

	Mass (g)	Reduced mass
Original frame	71.45	44%
Reinforced frame	128	0%
Proposal 1	81.32	36%
Proposal 2	75.98	41%
Proposal 3	70.79	45%

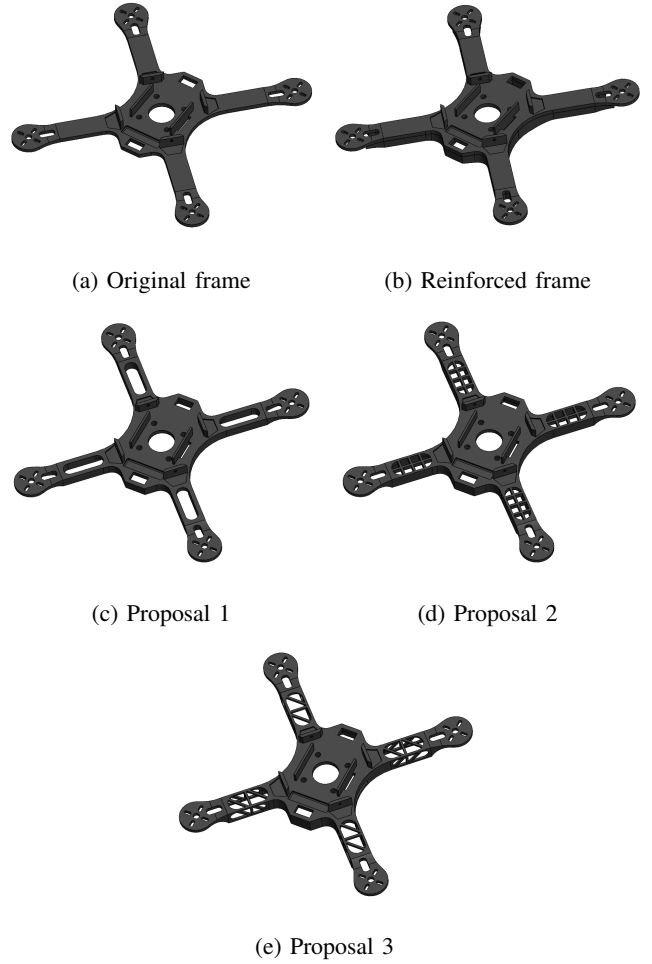

Fig. 8: Quadrotor frames

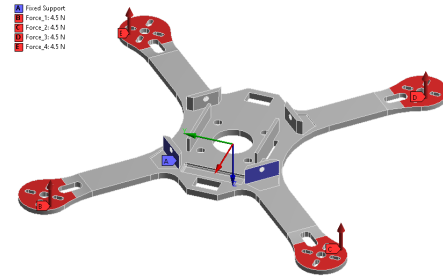

Fig. 9: Zones of supports and forces in quadrotor UAV frames

IV. RESULTS

The Finite Element Analysis is applied to all the quadrotor UAV designs, and their total deformation (Figure 10), as well as their stress distribution (see Figure 11), are each determined. The entire data obtained from the simulations is presented in Table III. From the figures and table mentioned above, the following is deduced.

The same tendency of maximum deformation at the ends of the arms is presented in all the frames, with the magnitude only varying. The stress distribution, however, has slight

variations but reveals the concentration of maximum stress at the beginning of the arms in common. A maximum deformation of 5.14 (mm), a relatively large value that would impact the performance of the quadrotor UAV, is shown in the original frame. The highest stress value (15.80 (MPa)) and the most extensive stress distribution from all designs, directly impacting the quadrotor UAV frame performance, is shown in this design.

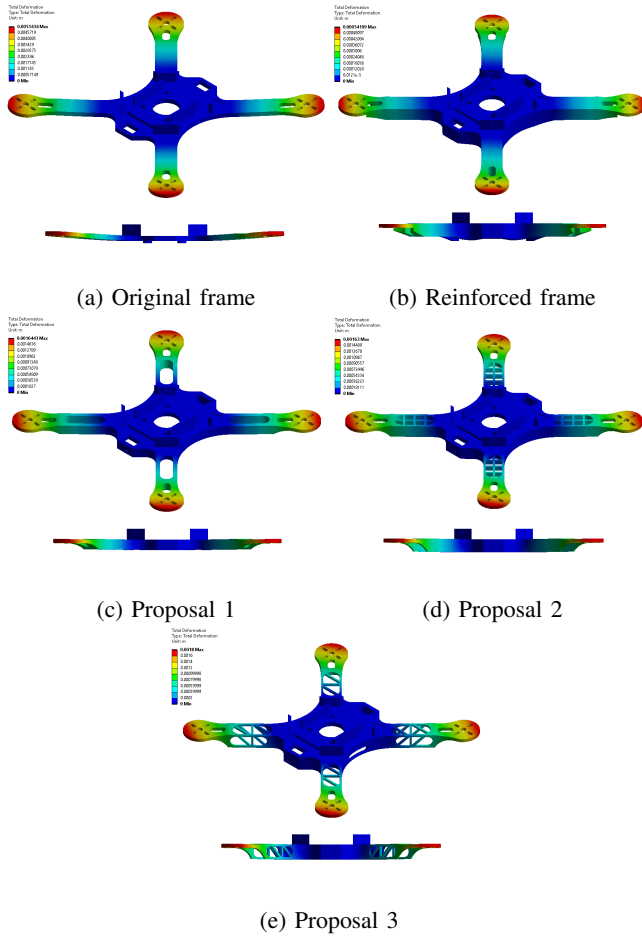

Fig. 10: Total deformation of all quadrotor designs

On the other hand, the reinforced frame shows a maximum deformation of 0.541 (mm), ten times lower than the original frame, which improved a lot, and buckling is solved. However, the increase in mass of 79% with respect to the original frame significantly affects the total weight of the quadrotor UAV, as is shown in Table II. In the case of the stresses, the lowest value (4.06 (MPa)) is shown in the reinforced frame, almost four times lower than the original frame. A significant reduction of stress is achieved in the reinforced frame, which is convenient because of the mechanical properties of PLA; nevertheless, as mentioned before, this design is not entirely convenient due to the large amount of mass it possesses, which can be diminished. A maximum deformation of 1.64 (mm) is shown in Proposal 1, three times lower than the original and three times larger than the reinforced. It possess proficient deformation results since

the arms do not significantly deflect in order to affect the quadrotor UAV performance. The maximum stress acquired on this frame is 9.98 (MPa), showing closely a 40% reduction with respect to the original and still far from the PLA yield strength value. The slightly less deformation and slightly higher stress values (1.63 (mm) and 10.12 (MPa), respectively) than Proposal 1 are presented in Proposal 2. These values are proximal to those obtained with Proposal 1, but represent 5% less mass than Proposal 1, making it an effective candidate for selection. Finally, a maximum deformation of 1.8 (mm) and 12.15 (MPa) of maximum stress is shown in Proposal 3. In this case, it presents significantly more deformation and stress with respect to proposals 1 and 2. However, it offers the lowest mass of all designs because of its three-dimensional arm structure design.

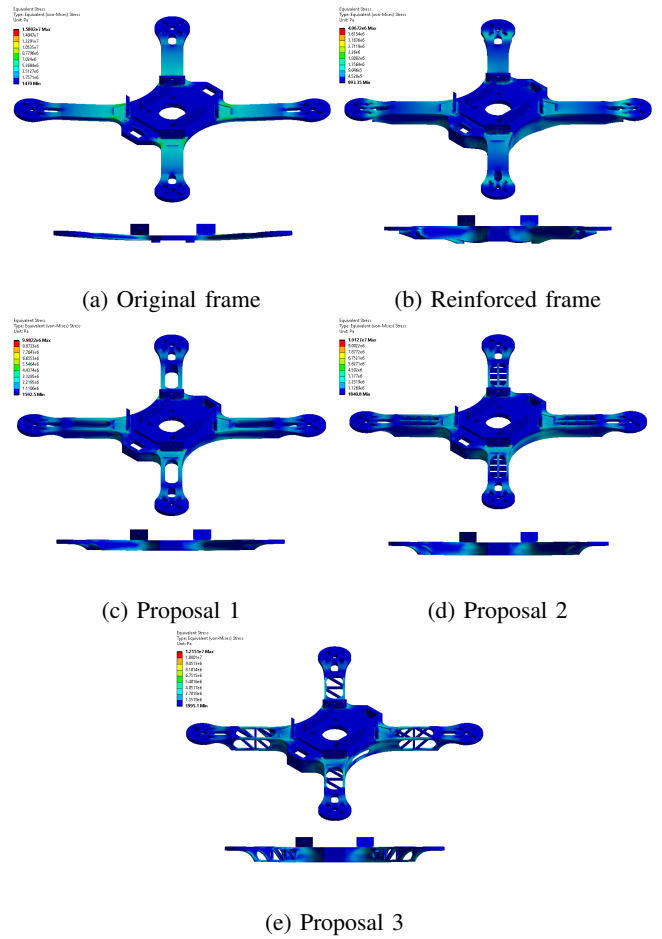

Fig. 11: Equivalent (von-Mises) stress of all quadrotor designs

TABLE III: Maximum deformation, maximum stress and mass from quadrotor UAV frames

	PLA				
	Original frame	Reinforced frame	Proposal 1	Proposal 2	Proposal 3
Max Deformation (mm)	5.14	0.54	1.64	1.63	1.8
Max Stress (MPa)	15.80	4.06	9.98	10.12	12.15
Mass (g)	71.45	128	81.32	75.98	70.79

V. CONCLUSIONS

Three frame proposals were designed for the quadrotor UAV. They were analyzed through simulations using the finite element technique to determine their deformations and maximum stresses when subjected to the maximum thrust loads of the rotors in trim flight conditions. The results of the reinforced frame of the quadrotor UAV were compared with the other three proposals for the modification of a new lightweight frame, concluding that the frame of proposal number two is the one that presents the best results according to the values obtained for the total deformation in the simulation. In addition, all the proposed frame designs are within the structural resistance limits of the PLA material. As a future work, other structural designs of the quadrotor UAV frame should be proposed in order to reduce the maximum stress obtained in the simulation results of this work. Likewise, new designs are proposed to be created so as to reduce the value of the frame mass and to diminish the buckling problem which is generated by the thrust of the rotors and presented in the arms of the quadrotor frame.

APPENDIX

QUADROTOR UAV COMPONENTS

The quadrotor UAV is equipped with four Brushless Direct Current (BLDC) motors with a speed of 2300 (KV); each BLDC motor is integrated with a three-bladed propeller known as a rotor. Each rotor is accompanied by an electronic speed controller (ESC) with a capacity of 30 (A), which is connected to a 12(V) power distribution board. The power distribution board is fueled by a 4S LiPo battery, which can supply enough power to run the four rotors, and the ESP32 microcontroller, which offers Wi-Fi and Bluetooth connectivity. The force-torque sensor used to carry out the tests with the quadrotor UAV is shown in Figure 12, and its technical specifications are presented in Table IV.

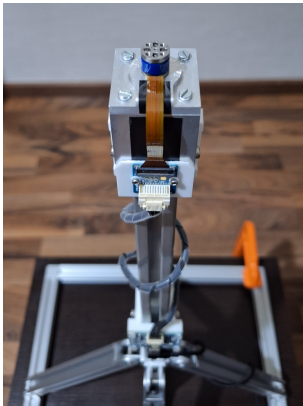

Fig. 12: Miniature force-torque sensor

The characteristics of the propeller thrust tester are shown in Table V.

The tachometer used in this work is shown in Figure 13, which has a measurement range of 2.5 to 99999 (RPM) with a resolution of 0.1 or 1 (RPM).

TABLE IV: Miniature force-torque sensor outline specifications

Size (Diameter x Height)	9.6×9.0 (mm)
Weight	3.0 (g)
Rated (Force, Moment)	40 (N), 0.4 ($N \cdot m$)
Load Capacity (Force, Moment)	200 (N), 1.8 ($N \cdot m$)
Resolution (Force, Moment)	0.1 (N), 0.001 ($N \cdot m$)
Interface	I ² C, SPI
Power-supply voltage	3.3 (V)

TABLE V: Propeller thrust tester specifications

Current	0 – 150 (A), error of 0.01 (A)
Voltage	0 – 60 (V), resolution of 0.01 (V)
Power	0 – 6554 (W), resolution of 0.1 (W)
Accurate test	0 – 10 (kg)



Fig. 13: Tachometer digital

The mass of the Reinforced frame is reduced by lightening in the arms and decreasing the average thickness. All of the proposed designs are developed following the previous approach. Therefore, they possess similarities in the general dimensions. Figure 14 shows the generalized comparison of the dimensions between the Reinforced frame and Proposal 1.

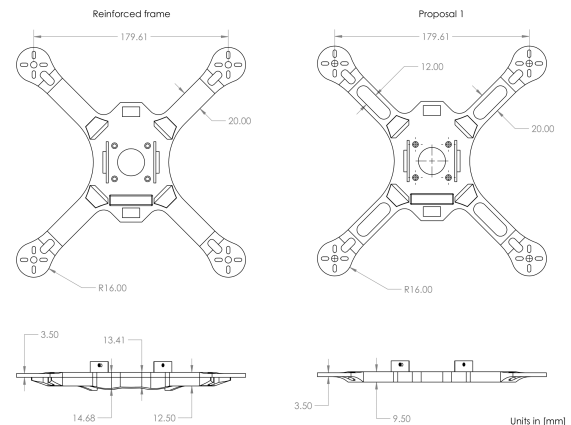

Fig. 14: Quadrotor Reinforced frame and Proposal 1 dimensions

FUNDING

This research work is supported by the Office of Naval Research Global through the award number N62909-20-1-2030.

ACKNOWLEDGMENTS

This research work is supported by CIIIA-FIME-UANL, and by Tecnológico Nacional de México / Instituto Tecnológico de La Laguna.

REFERENCES

- [1] de Oliveira, T.L., and de Carvalho, J. (2021). Design and numerical evaluation of quadrotor drone frame suitable for fabrication using fused filament fabrication with consumer-grade ABS. *Journal of the Brazilian Society of Mechanical Sciences and Engineering*, 43(9), 436.
- [2] Esakki, B., Mathiyazhagan, S., Moses, M., Rao, K.J., and Ganesan, S. (2019). Development of 3D-printed floating Quadrotor for collection of algae in remote water bodies. *Computers and Electronics in Agriculture*, 164, 104891.
- [3] Mehta, A.M., Rus, D., Mohta, K., Mulgaonkar, Y., Piccoli, M., and Kumar, V. (2016). A scripted printable quadrotor: Rapid design and fabrication of a folded MAV. In *Robotics Research: The 16th International Symposium ISRR* (pp. 203-219). Springer International Publishing.
- [4] Parandha, S.M., and Li, Z. (2018). Design and analysis of 3d printed quadrotor frame. *International Advanced Research Journal in Science, Engineering and Technology*, 5(4), 66-73.
- [5] Ahmad, F., Kumar, P., Khan, Y., and Patil, P.P. (2020). Flow and Structural Analysis of a Quadcopter UAV. *International Journal of Advanced Research in Engineering and Technology*, 11(8).
- [6] Kumar, V.A., Sivaguru, M., Janaki, B.R., Eswar, K.S., Kiran, P., and Vijayanandh, R. (2021, March). Structural Optimization of Frame of the Multi-Rotor Unmanned Aerial Vehicle through Computational Structural Analysis. In *Journal of Physics: Conference Series* (Vol. 1849, No. 1, p. 012004). IOP Publishing.
- [7] Magnussen, Ø., Hovland, G., and Ottestad, M. (2014, September). Multicopter UAV design optimization. In *2014 IEEE/ASME 10th International Conference on Mechatronic and Embedded Systems and Applications (MESA)* (pp. 1-6). IEEE.
- [8] Satra, M.K., and Shetty, S. (2017, December). Design Optimization and Manufacturing of Quadcopter Using 3D Printing. In *International Conference on Advances in Thermal Systems, Materials and Design Engineering (ATSMDE2017)*.
- [9] Bright, J., Suryaprakash, R., Akash, S., and Giridharan, A. (2021). Optimization of quadcopter frame using generative design and comparison with DJI F450 drone frame. In *IOP Conference Series: Materials Science and Engineering* (Vol. 1012, No. 1, p. 012019). IOP Publishing.
- [10] Nvss, S., Esakki, B., Yang, L.J., Udayagiri, C., and Vepa, K. S. (2022). Design and development of unibody quadcopter structure using optimization and additive manufacturing techniques. *Designs*, 6(1), 8.
- [11] Nvss, S., Esakki, B., Udayagiri, C., and Vepa, K.S. (2021). Multistage mass optimization of a quadcopter frame. In *Innovative Design, Analysis and Development Practices in Aerospace and Automotive Engineering: Proceedings of I-DAD 2020* (pp. 181-188). Springer Singapore.