



HAL
open science

Spatial dynamics of reaction-diffusion models

Mingmin Zhang

► **To cite this version:**

Mingmin Zhang. Spatial dynamics of reaction-diffusion models. Analysis of PDEs [math.AP]. Aix-Marseille Université; University of Science and Technology of China, 2021. English. NNT: 2021AIXM0392 . tel-04398734

HAL Id: tel-04398734

<https://cnrs.hal.science/tel-04398734>

Submitted on 16 Jan 2024

HAL is a multi-disciplinary open access archive for the deposit and dissemination of scientific research documents, whether they are published or not. The documents may come from teaching and research institutions in France or abroad, or from public or private research centers.

L'archive ouverte pluridisciplinaire **HAL**, est destinée au dépôt et à la diffusion de documents scientifiques de niveau recherche, publiés ou non, émanant des établissements d'enseignement et de recherche français ou étrangers, des laboratoires publics ou privés.

UNIVERSITÉ D'AIX MARSEILLE

École Doctorale de Mathématiques et Informatiques ED (184)

THÈSE

Présentée pour obtenir le grade de

DOCTEUR AIX-MARSEILLE UNIVERSITÉ

Spécialité : Mathématiques Appliquées

par

Mingmin ZHANG

Directeur de thèse: François HAMEL

Co-Directeur de thèse: Xing LIANG

Spatial dynamics of reaction-diffusion models

Soutenue le 28 Septembre 2021 devant le jury composé de

Mme	Guillemette Chapuisat	Aix-Marseille Université
M.	Arnaud Ducrot	Université Le Havre Normandie
M.	François Hamel	Aix-Marseille Université
M.	Xing Liang	University of Science and Technology of China
M.	Yuan Lou	Ohio State University et Shanghai Jiao Tong University
M.	Philippe Souplet	Université Sorbonne Paris Nord
M.	Xuefeng Wang	The Chinese University of Hong Kong-Shenzhen
Mme	Yaping Wu	Capital Normal University

Rapportée par

M. Arnaud Ducrot Université Le Havre Normandie

M. Xuefeng Wang The Chinese University of Hong Kong-Shenzhen

Résumé

Cette thèse s'intéresse aux fronts progressifs et aux phénomènes de propagation des EDP non linéaires (principalement les équations de réaction-diffusion) apparaissant en physique, biologie, sciences médicales, etc. Les principaux résultats sont déclinés dans quatre parties.

Dans la première partie, on a considéré un modèle de flamme prémélangée avec une cinétique à température d'ignition différente de la cinétique classique d'Arrhenius, pour laquelle ce modèle décrit la dynamique des flammes épaisses. Lorsque le nombre de Lewis est grand ($Le > 1$), des pulsations périodiques sont observées, ce que nous avons cherché à caractériser mathématiquement. On considère la flamme comme une interface à déterminer dans un problème à frontière libre, lequel est transformé en une équation parabolique totalement non linéaire. Nous avons démontré l'existence d'une bifurcation de Hopf.

Dans la deuxième partie, nous considérons des modèles de type champ-route proposés par Berestycki *et al.* dans le but de décrire l'influence d'une ligne à diffusion rapide sur la propagation des espèces invasives. Nous considérons d'abord ce modèle dans des environnements spatialement périodiques et montrons l'existence d'une vitesse de propagation qui s'avère être la vitesse minimale des fronts pulsatoires. Ensuite, nous étudions le problème elliptique de ce modèle et montrons l'existence de solutions faibles non triviales dans les domaines bornés et non bornés.

Dans la troisième partie, on considère des équations bistables dans des domaines de \mathbb{R}^N en forme d'entonnoir constitué d'une partie cylindrique droite et d'une partie conique. Nous étudions la dynamique en temps grand de solutions entières émanant d'un front plan dans la partie droite et se déplaçant dans la partie conique. Nous montrons une dichotomie entre blocage et invasion. Nous montrons également que toute solution se propageant complètement est un front de transition ayant une vitesse moyenne globale, qui est l'unique vitesse des fronts plans, et qu'elle converge en temps grand dans la partie conique vers un front courbe dont la position est approchée par des sphères de rayons de plus en plus grands. De plus, nous fournissons des conditions suffisantes sur la taille R de la partie droite et sur l'angle d'ouverture α de la partie conique, sous lesquelles la solution émanant d'un front plan se bloque ou se répand complètement dans la partie conique. On montre enfin que l'ensemble des paramètres (R, α) pour lequel la propagation est complète est un ensemble ouvert.

Dans la dernière partie, nous considérons un modèle unidimensionnel constitué d'une succession d'équations de réaction-diffusion dans des milieux homogènes, où de nouvelles conditions de couplage aux interfaces sont introduites pour refléter le mouvement des individus lorsqu'ils passent entre deux milieux adjacents. Dans un premier temps, nous considérons ce modèle dans un environnement spatialement périodique. Nous établissons rigoureusement le caractère bien posé du problème de Cauchy. Nous étudions en outre les propriétés d'étalement et l'existence de fronts pulsatoires dans les directions positive et négative. Deuxièmement, nous étudions un modèle simplifié constitué de deux milieux homogènes dans \mathbb{R} . Nous montrons tout d'abord des propriétés d'étalement des solutions dans le cas KPP-KPP. Ensuite, dans le cadre KPP-bistable, nous étudions différentes conditions dans lesquelles les solutions du problème de Cauchy peuvent avoir différentes dynamiques dans le milieu bistable, à savoir le blocage, le blocage virtuel ou la propagation. En particulier, lorsque la propagation se produit, un résultat de stabilité globale est prouvé. Les résultats dans le cadre KPP-bistable peuvent également être étendus au cadre bistable-bistable sous certaines hypothèses.

Mots-clés : équations aux dérivées partielles, réaction-diffusion, fronts pulsatoires, fronts de transition, vitesse de propagation, phénomènes de propagation

Abstract

This dissertation is concerned with traveling fronts and propagation phenomena of nonlinear PDEs (mainly the reaction-diffusion equations) arising in physics, biology and medical science, etc. The main results consist of the following four parts.

In the first part, we considered a premixed flame model with an ignition temperature kinetics different from the classical Arrhenius kinetics, for which this model describes the dynamics of thick flames. When the Lewis number is large, pulsating instabilities are observed, which we have sought to characterize mathematically. We consider the flame as an interface to be determined in a free interface problem, which is transformed into a totally nonlinear parabolic equation. We prove the existence of a Hopf bifurcation.

In the second part, we consider the so-called field-road model proposed by Berestycki *et al.* for the purpose of describing the influence of a line with fast diffusion on the propagation of invasive species. We first consider this model in spatially periodic environments and show the existence of asymptotic spreading speed which turns out to be the minimal speed of pulsating traveling waves. Then, we investigate the elliptic problem of this model and prove the existence of nontrivial weak solutions in bounded and unbounded domains.

In the third part, we consider bistable equations in funnel-shaped domains of \mathbb{R}^N made up of straight parts and conical parts. We investigate the large time dynamics of entire solutions emanating from a planar front in the straight part and moving into the conical part. We show a dichotomy between blocking and spreading. We also show that any spreading solution is a transition front having a global mean speed, which is the unique speed of planar fronts, and that it converges at large time in the conical part to a well-formed front whose position is approximated by expanding spheres. Moreover, we provide sufficient conditions on the size R of the straight part and on the opening angle α of the conical part, under which the solution emanating from a planar front is blocked or spreads completely in the conical part. We finally show the openness of the set of parameters (R, α) for which the propagation is complete.

In the last part, we consider a one-dimensional patchy model made up of a succession reaction-diffusion equations in homogeneous media, where novel interface matching conditions are introduced to reflect the movement behavior of individuals when they come to the edge of a

patch. Firstly, we consider this model in a spatially periodic environment. We establish the well-posedness rigorously for the Cauchy problem. We then investigate the spreading properties and the existence of pulsating traveling waves in the positive and negative directions. Secondly, we study a simplified two patchy model in \mathbb{R} which consists of two homogeneous habitats. We first derive the spreading properties of solutions in KPP-KPP case. Then, in KPP-bistable framework we investigate different conditions under which the solutions of the Cauchy problem may show different dynamics in the bistable patch, that is, blocking, virtual blocking or propagation. In particular, when propagation occurs, a global stability result is proved. The results in KPP-bistable frame can also be extended to the bistable-bistable setting with certain hypotheses.

Keywords: partial differential equations, reaction-diffusion, pulsating fronts, transition fronts, spreading speeds, propagation phenomena

Acknowledgments

This thesis would have never been finished without the contribution of many people. To all of them I would like to express my sincere gratitude.

First of all, I deeply thank my supervisor Prof. François Hamel, who has shaped my idea of what it means to be a researcher, for suggesting research projects that I am passionate about, for sharing his mathematical thought processes in an enlightening and educational way, for accepting to supervise me and for handling many administrative challenges related to my PhD arrangement. I cannot thank you enough for your guidance, your time and patience, your support and encouragement. I also warmly thank my co-supervisor Prof. Xing Liang, who introduced me to the world of reaction-diffusion equations, spent lots of time in seminars with us, shared with us his experience of academic research, suggested collaborations and put me in touch with Prof. François Hamel. Thanks to them, I had numerous opportunities to attend talks, conferences, summer schools and had chances to meet, learn from and work with many excellent mathematicians. The time of my PhD was really enjoyable due to their great support and generosity. I am extremely honored and lucky to be a student of them, to learn from them and to be part of their academic family.

Special thanks go to Prof. Claude-Michel Brauner and Prof. Michel Chipot, for being great mentors, for your support and encouragement, for your care and help. Thank you for taking care of me as if I would be one of your own students.

I am also grateful to professors Luca Lorenzi, Thomas Giletti, Frithjof Lutscher, Lenya Ryzhik and Luca Rossi for fruitful discussions, virtual and real, and for teaching me new interesting mathematics.

A big thank you to Prof. Xiao-Qiang Zhao for giving me much guidance, for letting me participate in their weekly seminar and for encouraging me to present my works there.

I sincerely thank professors Guillemette Chapuisat and Grégoire Nadin for being my PhD monitoring committee members.

I have a special acknowledgment to my thesis committee members: Guillemette Chapuisat, Arnaud Ducrot, Yuan Lou, Philippe Souplet, Xuefeng Wang and Yaping Wu.

I would also like to thank professors Assia Benabdallah, Thierry Coulbois, Yves Dermenjian, Peter Haissinsky, Florence Hubert, Enea Parini, Lionel Nguyen Van Thé and many others from I2M for their kind help and support, and thank the administrative team: Sonia

Asseum, Valérie Demare, Evelyne Henri, Valérie Jourdan, Marie-Christine Tort and many others.

I also thank Weiwei Ding, Hongjun Guo, Zhenhui Bu and Weijie Sheng for their kind help. Let me also mention my friends in I2M: Lydia, Nissa, Arnaud, Yannis, Clément, Anaïs, Antoine, Aurélien, Juan, Emily, Enguerrand, Yen, Romain, Romeo, Adam, Firas, Alphonse... It is a great pleasure to meet you. Thank you all for always being warm and for bringing me to try lots of new things! Thanks also go to my Chinese friends in Marseille: Jingke Hou, Shuolin Li, Jingtao Ma, Na Shao, Qiujuan Shen, Jing Wan, Ziwen Wang, Fanghui Zhang, Wenzheng Zhang... With you around, everything went well. The pleasant time we spent together was and will always be great memories of me!

Thanks to Aix-Marseille Université and University of Science and Technology of China for providing excellent atmosphere. I also thank the China Scholarship Council for the two-year financial support during my stay in Marseille.

Last but not least, I would like to thank my family for their love and constant support, and thank Zhaoyun Zhang for being the special person in my life who is always there for me, no matter where, no matter when.

Contents

Résumé	ii
Abstract	iv
Acknowledgments	vi
1 General introduction	1
1.1 Stability analysis and Hopf bifurcation in a combustion model	3
1.2 The study of the field-road model	7
1.3 Reaction-diffusion fronts in funnel-shaped domains	17
1.4 Propagation phenomena in patchy landscapes with interface conditions	26
1.5 Open problems and perspectives	49
2 Stability analysis and Hopf bifurcation at high Lewis number in a combustion model with free interface	51
2.1 Introduction	51
2.2 The linearized operator	55
2.2.1 The system with fixed interface	55
2.2.2 Ansatz 1	56
2.2.3 The linearized problem	58
2.2.4 Analysis of the operator L	59
2.3 The fully nonlinear problem	65
2.3.1 Ansatz revisited: elimination of the eigenvalue 0	65
2.3.2 Derivation of the fully nonlinear equation	66
2.4 Stability of the traveling wave solution	67
2.4.1 Stability of the null solution of (2.48)	68
2.4.2 Stability of the traveling wave	70
2.5 Hopf bifurcation	71
2.5.1 Local analysis of the dispersion relation	71
2.5.2 Hopf bifurcation theorem	74

2.5.3	Bifurcation from the traveling wave	77
2.6	Appendix	78
2.6.1	General solution to the equation $\lambda \mathbf{u} - \mathcal{L}\mathbf{u} = \mathbf{f}$	78
2.6.2	On the equality $k_{1,\lambda} = k_{3,\lambda}$	79
2.6.3	The coefficients of the polynomial $P_7(\cdot; m, \varepsilon)$	81
3	Spreading speeds and pulsating fronts for a field-road model in a spatially periodic habitat	83
3.1	Introduction	83
3.2	Hypotheses and main results	86
3.3	Preliminaries	91
3.3.1	Preliminary results in the half-plane	91
3.3.2	Preliminary results in the strip	95
3.4	Propagation properties in the strip: Proofs of Theorems 3.3 and 3.5	100
3.5	Propagation properties in the half-plane: Proofs of Theorems 3.6 and 3.8	115
3.5.1	The generalized eigenvalue problem in the half-plane	115
3.5.2	Spreading speeds and pulsating fronts in the half-plane	119
4	On some model problem for the propagation of interacting species in a special environment	123
4.1	Introduction and notation	123
4.2	Preliminary results	126
4.3	The main result	132
4.4	Some extension	135
4.5	The case of an unbounded domain	142
5	Reaction-diffusion fronts in funnel-shaped domains	149
5.1	Introduction and main results	149
5.1.1	Notations	151
5.1.2	Background	152
5.1.3	General properties for any given (R, α)	155
5.1.4	Complete propagation for large R	159
5.1.5	Blocking for $R \ll 1$ and α not too small	160
5.1.6	The set of parameters (R, α) with complete propagation is open in $(0, +\infty) \times (0, \pi/2)$	161
5.2	Existence and uniqueness for problem (5.1) with past condition (5.9)	162
5.3	Dichotomy between complete propagation and blocking	166
5.3.1	Auxiliary Liouville type results for (5.17) in funnel-shaped domains	166
5.3.2	Auxiliary Liouville type results for stable solutions of $\Delta U + f(U) = 0$	169
5.3.3	Proof of Theorem 5.3	175

5.4	Transition fronts and long-time behavior of the level sets	180
5.4.1	Proof of Theorem 5.7	180
5.4.2	Proof of Theorem 5.6	181
5.5	Sufficient conditions on (R, α) for complete propagation or for blocking	193
5.5.1	Complete propagation for $R \geq R_0$ and $\alpha \in (0, \pi/2)$: proof of Theorem 5.8	193
5.5.2	Blocking for $R \ll 1$ and α not too small: proof of Theorem 5.9	193
5.6	The set of (R, α) with complete propagation property is open in $(0, +\infty) \times (0, \pi/2)$	201
6	Propagation phenomena in periodic patchy landscapes with interface conditions	203
6.1	Introduction	203
6.2	Model presentation and statement of the main results	207
6.2.1	The model and some equivalent formulations	207
6.2.2	Well-posedness of the Cauchy problem (6.12)–(6.13)	210
6.2.3	Existence, uniqueness and attractiveness of a positive periodic steady state	211
6.2.4	Spreading speeds and pulsating traveling waves	214
6.3	Well-posedness of the Cauchy problem (6.12)–(6.13): proof of Theorem 6.2	216
6.3.1	Truncated problem	216
6.3.2	Proof of Theorem 6.2	225
6.4	Existence and uniqueness of a stationary solution	231
6.4.1	Existence of solutions: proof of Theorem 6.3	231
6.4.2	Uniqueness of solutions: proof of Theorem 6.4	233
6.5	Long-time behavior: proof of Theorem 6.5	243
6.6	Spreading speeds and periodic traveling waves: proofs of Theorems 6.6 and 6.8	245
6.7	Comparison principles	258
7	Propagation and blocking in a two-patch reaction-diffusion model	265
7.1	Introduction	265
7.2	Definitions and main results	270
7.2.1	Existence results for the Cauchy problem associated with (7.3)	271
7.2.2	Propagation in the KPP-KPP case	272
7.2.3	Persistence, blocking or propagation in the KPP-bistable case	274
7.2.4	Blocking or propagation in the bistable-bistable case	279
7.2.5	Biological interpretation and explanation	282
7.3	The KPP-KPP case	284
7.4	The KPP-bistable case	289
7.4.1	Semi-persistence result: proof of Theorem 7.8	290

7.4.2	Preliminaries on the stationary problem: proofs of Propositions 7.10–7.12	293
7.4.3	Blocking in the bistable patch 2: proofs of Theorems 7.13–7.15	303
7.4.4	Propagation in the bistable patch 2: proofs of Theorems 7.16–7.17	310
7.5	The bistable-bistable case	327
7.6	Appendix	329
Bibliography		333

Chapter 1

General introduction

This dissertation is devoted to mathematical study of some models arising in the fields of physics, chemistry, biology and medical science, etc.

Stability analysis of free boundary problems, or equivalently free interface problems, have been for long a challenging issue (see, e.g., [132, 71]). In combustion theory, stability of propagating premixed flames is a complex and difficult problem. In contrast to conventional Arrhenius kinetics where the reaction zone is infinitely thin, the reaction zone for stepwise temperature kinetics is of order unity (thick flame). Models describing dynamics of thick flames with stepwise ignition-temperature kinetics have recently received considerable attention (see [35]). For relatively small Lewis number ($Le < 1$), the traveling wave has cellular instabilities, i.e. pattern formation, for which a paradigm for the evolution of the disturbed flame front is the Kuramoto-Sivashinsky equation (see [126, 148], and also [38, 39, 40, 41, 44]). However, for the case of high Lewis number ($Le > 1$), there is only a numerical result (see [35, Section 3.2]) showing that large enough Lewis numbers give rise to pulsating instabilities, i.e., oscillatory behavior of the flame. With this motivation, we aim to give a rigorous analysis of the stability of traveling waves in the case of $Le > 1$ from mathematical point of view.

Then, we turn to reaction-diffusion problems which read

$$u_t = \Delta u + f(u), \quad t > 0, x \in \mathbb{R}^N. \quad (1.1)$$

This type of models arises in population dynamics and has been used to simulate, explain and predict numerous phenomena in ecology, species survival and medical science, etc. Such type of equations was first introduced by the parallel pioneering works of Fisher [77] and Kolmogorov, Petrovsky and Piskunov [108] to model the spatial spread of advantageous genetic features, where the nonlinear reaction term obeys logistic growth. It is then called the Fisher-KPP equation or KPP equation, with the KPP assumption that $f(0) = f(1) = 0$ and $0 < f(s) \leq f'(0)s$ in $s \in (0, 1)$. Skellam in 1951 [149] used this KPP equation to study spatial propagation of species and proposed quantitative explanations for the spread of

1. General introduction

muskrats throughout Europe at the beginning of the 20th century. Aronson and Weinberger [8, 9] then gave a rigorous formalization of spreading properties.

Theorem 1.1. *Let $u(t, x)$ be the solution of (1.1) with a nonnegative, bounded, continuous and compactly supported initial function $u_0 \not\equiv 0$. Then, $u(t, x)$ spreads with speed $c^* := 2\sqrt{f'(0)}$ in all directions for large times, namely*

$$\begin{cases} \max_{|x| \leq ct} |u(t, x) - 1| \rightarrow 0, & \text{as } t \rightarrow +\infty, \text{ if } 0 \leq c < c^*, \\ \max_{|x| \geq ct} u(t, x) \rightarrow 0, & \text{as } t \rightarrow +\infty, \text{ if } c > c^*. \end{cases}$$

Meanwhile, it is also well-known [108, 8, 9] that this equation has a family of planar traveling fronts $u(t, x) = U(x \cdot e - ct)$ with direction $e \in \mathbb{S}^{N-1}$, $U > 0$, $U(-\infty) = 1$ and $U(+\infty) = 0$ if and only if $c \geq c^* = 2\sqrt{f'(0)}$, which is unique (up to shifts in space or time variables).

However, most landscapes are not homogeneous, therefore it is necessary to involve heterogeneous situations into the models. In this spirit, we take into consideration a simple but typical case: spatial periodicity, for which standard traveling fronts do not exist in general. Instead, the notion of traveling fronts is replaced by the more general concept of pulsating fronts [146]. Assume that (1.1) admits a periodic positive steady state $p(x)$, a pulsating traveling front connecting 0 and $p(x)$ is a solution of the type $u(t, x) = U(x \cdot e - ct, x)$ with $c \neq 0$ representing the propagation speed and $e \in \mathbb{S}^{N-1}$ the direction of propagation, if the function $U : \mathbb{R} \times \mathbb{R}^N \rightarrow \mathbb{R}$ satisfies

$$\begin{cases} U(-\infty, x) = p(x), \quad U(+\infty, x) = 0 \text{ uniformly in } x \in \mathbb{R}^N, \\ U(s, \cdot) \text{ is periodic in } \mathbb{R}^N \text{ for all } s \in \mathbb{R}. \end{cases}$$

Moreover, the spreading properties may differ with respect to different directions.

On the other hand, if f satisfies bistable hypothesis, i.e. $f(0) = f(\theta) = f(1) = 0$ for some $\theta \in (0, 1)$, $f'(0) < 0$, $f'(\theta) < 0$, $f'(1) < 0$, $f(s) < 0$ for $s \in (0, \theta)$ and $f(s) > 0$ for $s \in (\theta, 1)$, it is known [76] that (1.1) has a unique (up to shifts) traveling wave solution $u(t, x) = U(x \cdot e - ct)$, with direction $e \in \mathbb{S}^{N-1}$, $U > 0$, $U(-\infty) = 1$ and $U(+\infty) = 0$, and with a unique propagation speed $c \in \mathbb{R}$ depending only on f and having the sign of $\int_0^1 f(s) ds$. The geometrical effect of the underlying domain on propagation phenomena of the solution to bistable equations has received much attention. For instance, it was studied in the real line \mathbb{R} (with periodic heterogeneities [59, 60, 66, 93, 158, 160, 164], with local defects [29, 47, 110, 127, 137, 151], or with asymptotically distinct left and right environments [68]), as well as in straight infinite cylinders with non-constant drifts [69, 70], and in some periodic domains [64] or the whole space with periodic coefficients [65, 85]. In [139], a reaction-diffusion model was considered to analyze the effects on population persistence of simultaneous changes in the position and shape of a climate envelope. In [118, 125], for a model of curvature-driven motion of plane

curves in two-dimensional cylinders with undulating boundaries, various existence and non-existence results of traveling waves were proved, as well as the phenomenon of virtual pinning, that is, the propagation of waves with zero speed. The interaction between smooth compact obstacles $K \subset \mathbb{R}^N$ and a bistable planar front $\phi(x_1 - ct)$ was studied in [20]. Recently, the existence and characterization of the global mean speed of reaction-diffusion transition fronts in domains with multiple cylindrical branches were investigated in [88].

The rest of the dissertation is to study the spatial dynamics and propagation phenomena of specific problems and understand how the geometry of the “funnel-shaped” domains affect propagation phenomena of bistable reaction-diffusion equations, based on the known results above. Meanwhile, we will also study weak solutions of an elliptic problem. In the remainder of this chapter, we state the main results of this dissertation.

1.1 Stability analysis and Hopf bifurcation in a combustion model

This section is devoted to the stability analysis of a unique (up to translation) traveling wave solution to a thermo-diffusive model of flame propagation with stepwise temperature kinetics and first-order reaction (see [35]) at high Lewis numbers, namely $Le > 1$. The problem reads in one spatial dimension:

$$\begin{cases} \frac{\partial \Theta}{\partial t} = \frac{\partial^2 \Theta}{\partial x^2} + W(\Theta, \Phi), \\ \frac{\partial \Phi}{\partial t} = Le^{-1} \frac{\partial^2 \Phi}{\partial x^2} - W(\Theta, \Phi). \end{cases} \quad (1.2)$$

Here, Θ and Φ are appropriately normalized temperature and concentration of deficient reactant, $x \in \mathbb{R}$ denotes the spatial coordinate, $t > 0$ the time. The nonlinear term $W(\Theta, \Phi)$ is a scaled reaction rate given by (see [35, Section 2, formula (3)]):

$$W(\Theta, \Phi) = \begin{cases} A\Phi, & \text{if } \Theta \geq \Theta_i, \\ 0, & \text{if } \Theta < \Theta_i. \end{cases} \quad (1.3)$$

In (1.3), $0 < \Theta_i < 1$ is the reduced ignition temperature, $A > 0$ is a normalized factor depending on Θ_i and Le , to be determined hereafter for the purpose of ensuring that the speed of traveling wave is set at unity. Moreover, the following boundary conditions hold at $\pm\infty$:

$$\begin{aligned} \Theta(t, -\infty) &= 1, & \Theta(t, \infty) &= 0, \\ \Phi(t, -\infty) &= 0, & \Phi(t, \infty) &= 1. \end{aligned} \quad (1.4)$$

1. General introduction

In this first-order stepwise kinetics model, Φ does not vanish except as t tends to $-\infty$. Thus, problem (1.2)-(1.4) belongs to the class of parabolic PDEs with discontinuous nonlinearities. Models in combustion theory and other fields (see, e.g. [2, Section 1]) involving discontinuous reaction terms have been used by physicists and engineers for long because of their manageability; as a result, elliptic and parabolic PDEs with discontinuous nonlinearities, and related Free Boundary Problems, have received a close attention from the mathematical community (see [1, Section 1] and references therein). We quote in particular the paper [48], by K.-C. Chang, which contains a systematical study of elliptic PDEs with discontinuous nonlinearities.

We consider the case of a free *ignition interface* $g(t)$ defined by

$$\Theta(t, g(t)) = \Theta_i, \quad (1.5)$$

such that $\Theta(t, x) > \Theta_i$ for $x > g(t)$ and $\Theta(t, x) < \Theta_i$ for $x < g(t)$. Formula (2.4) means that the ignition temperature Θ_i is reached at the ignition interface which defines the flame front. We point out that, in contrast to conventional Arrhenius kinetics where the reaction zone is infinitely thin, the reaction zone for stepwise temperature kinetics is of order unity (thick flame). It is also interesting to compare the first-order stepwise kinetics with the zero-order kinetics model (see [1, 35, 37]): in the zero-order kinetics, $\Phi(t, x)$ vanishes at a *trailing interface* and does not appear explicitly in the nonlinear term (see [35, Section 2, formula (4)]).

According to (1.5), the system for $\mathbf{X} = (\Theta, \Phi)$ reads as follows, for $t > 0$ and $x \in \mathbb{R}, x \neq g(t)$:

$$\begin{cases} \frac{\partial \Theta}{\partial t} = \frac{\partial^2 \Theta}{\partial x^2} + A\Phi, & x < g(t), \\ \frac{\partial \Phi}{\partial t} = \text{Le}^{-1} \frac{\partial^2 \Phi}{\partial x^2} - A\Phi, & x < g(t), \end{cases} \quad (1.6)$$

$$\begin{cases} \frac{\partial \Theta}{\partial t} = \frac{\partial^2 \Theta}{\partial x^2}, & x > g(t), \\ \frac{\partial \Phi}{\partial t} = \text{Le}^{-1} \frac{\partial^2 \Phi}{\partial x^2}, & x > g(t). \end{cases} \quad (1.7)$$

At the free interface $x = g(t)$, the following continuity conditions hold:

$$[\Theta] = [\Phi] = 0, \quad \left[\frac{\partial \Theta}{\partial x} \right] = \left[\frac{\partial \Phi}{\partial x} \right] = 0, \quad (1.8)$$

where we denote by $[f]$ the jump of a function f at a point x_0 , i.e., the difference $f(x_0^+) - f(x_0^-)$.

The system above admits a unique (up to translation) traveling wave solution $\mathbf{U} =$

(Θ^0, Φ^0) which propagates with constant positive velocity V . In the moving frame coordinate $z = x - Vt$, by choosing

$$A = \frac{\Theta_i}{1 - \Theta_i} \left(1 + \frac{\Theta_i}{\text{Le}(1 - \Theta_i)} \right), \quad (1.9)$$

to have $V = 1$ and, hence, $z = x - t$, the traveling wave solution is explicitly given by the following formulae:

$$\Theta^0(z) = \begin{cases} 1 - (1 - \Theta_i)e^{\frac{\Theta_i}{1-\Theta_i}z}, & z < 0, \\ \Theta_i e^{-z}, & z > 0, \end{cases}$$

$$\Phi^0(z) = \begin{cases} \frac{\Theta_i}{A(1 - \Theta_i)} e^{\frac{\Theta_i}{1-\Theta_i}z}, & z < 0, \\ 1 + \left(\frac{\Theta_i}{A(1 - \Theta_i)} - 1 \right) e^{-\text{Le}z}, & z > 0. \end{cases}$$

The goal of this work is the analysis of the stability of the traveling wave solution \mathbf{U} in the case of high Lewis numbers ($\text{Le} > 1$). Here, stability refers to orbital stability with asymptotic phase, because of the translation invariance of the traveling wave. It is known (see [35, Section 3.2]) that large enough Lewis numbers give rise to *pulsating instabilities*, i.e., oscillatory behavior of the flame. This is very unlike *cellular instabilities* for relatively small Lewis number ($\text{Le} < 1$), that is pattern formation; in the latter case, a paradigm for the evolution of the disturbed flame front is the Kuramoto-Sivashinsky equation (see [126, 148], and also [38, 39, 40, 41, 44]).

The analysis is organized as follows: We first transform the free interface problem to a system of parabolic equations on a fixed domain. Then, in the spirit of [42, 115, 116], the perturbation \mathbf{u} of the traveling wave \mathbf{U} is split as $\mathbf{u} = s \frac{d\mathbf{U}}{d\xi} + \mathbf{v}$ (“ansatz 1”), in which s is the perturbation of the front g . Then we give a thorough study of the linearization at 0 of the elliptic part of the parabolic system in a weighted space \mathcal{W} where its realization L is sectorial (see Subsection 2.2.3 for further details about the use of a weighted space). Furthermore, we determine the spectrum of L which contains $(-\infty, -\frac{1}{4}]$, a parabola and its interior, the roots of the so-called dispersion relation, and the eigenvalue 0. Thereafter, an important point is to get rid of the eigenvalue 0 which, as it has been already stressed, is generated by translation invariance. In Section 2.3, we use a spectral projection P as well as “ansatz 2” and then derive the fully nonlinear problem (see, e.g. [119]) for \mathbf{w} :

$$\frac{\partial \mathbf{w}}{\partial \tau} = (I - P)L\mathbf{w} + F(\mathbf{w}).$$

1. General introduction

Next, we use the bifurcation parameter m defined by

$$m := \frac{\Theta_i}{1 - \Theta_i}$$

to investigate the stability of the traveling wave. Simultaneously, as one already noted that pulsating instability is likely to occur at large Lewis number, it is natural to introduce a small perturbation parameter $\varepsilon > 0$ (dimensionless diffusion coefficient) defined by $\varepsilon := \text{Le}^{-1}$, so that (1.9) reads $A = m + \varepsilon m^2$. The simplest situation arises in the asymptotic case of gasless combustion when $\text{Le} = \infty$, as in [79]. As it is easily seen, as $\varepsilon \rightarrow 0$, problem (1.6)-(1.7) converges formally to:

$$\begin{cases} \frac{\partial \Theta}{\partial t} = \frac{\partial^2 \Theta}{\partial x^2} + A\Phi, & x < g(t), \\ \frac{\partial \Phi}{\partial t} = -A\Phi, & x < g(t), \end{cases} \quad (1.10)$$

$$\begin{cases} \frac{\partial \Theta}{\partial t} = \frac{\partial^2 \Theta}{\partial x^2}, & x > g(t), \\ \Phi \equiv 1, & x > g(t), \end{cases} \quad (1.11)$$

with conditions $[\Theta] = [\Phi] = 0$, $\left[\frac{\partial \Theta}{\partial x}\right] = 0$ at the free interface $x = g(t)$. However, the limit free interface system (1.10)-(1.11) is only partly parabolic.

Our first main result is:

Theorem 1.2. *Set $m^c = 6$. The following properties are satisfied.*

- (i) *For $m \in (2, m^c)$ fixed, there exists $\varepsilon_0 = \varepsilon_0(m) > 0$ such that, for $\varepsilon \in (0, \varepsilon_0)$, the traveling wave solution \mathbf{U} is orbitally stable.*
- (ii) *For $m > m^c$ fixed, there exists $\varepsilon_1 = \varepsilon_1(m)$ small enough such that, for $\varepsilon \in (0, \varepsilon_1)$, the traveling wave \mathbf{U} is unstable.*

Then, we prove the existence of Hopf bifurcation in a neighborhood of the critical value $m^c = 6$, see Theorem 2.10. Since the notations in the statement are quite relevant to the technical preliminaries, we skip the statement here.

1.2 The study of the field-road model

Spreading speeds and pulsating fronts for a field-road model in a spatially periodic habitat

In this subsection, we aim to study propagation properties for a field-road model in a spatially periodic environment. Taking into account this heterogeneity in space, we shall establish the existence of the asymptotic spreading speed and its coincidence with the minimal wave speed of pulsating traveling fronts in the direction of the road. In this work, the line $\{(x, 0) : x \in \mathbb{R}\}$ will be referred to as the road in the plane \mathbb{R}^2 . The heterogeneity is assumed to appear in x -direction. Then by symmetry, we can consider the upper half-plane $\Omega := \{(x, y) \in \mathbb{R}^2 : y > 0\}$ as the field. Denote by $u(t, x)$ the linear density of population on the road and by $v(t, x, y)$ the areal density of population in the field. Such a model can be understood as the low-dimensional case of the “bulk-surface model” (involving volumetric densities and surface densities) where the surface has no thickness. The population in the field is assumed to be governed by a Fisher-KPP equation with diffusivity d and heterogeneous nonlinearity $f(x, v)$, whereas the population on the road is subject to a diffusion equation with diffusivity $D > 0$ which is a priori different from d . Moreover, there are exchanges between the road and the field in which the parameter $\mu > 0$ stands for the rate of individuals on the road going into the field, while the parameter $\nu > 0$ represents the rate of individuals passing from the field to the road. Therefore, we are led to the following system:

$$\begin{cases} \partial_t u - D\partial_{xx}u = \nu v(t, x, 0) - \mu u, & t > 0, x \in \mathbb{R}, \\ \partial_t v - d\Delta v = f(x, v), & t > 0, (x, y) \in \Omega, \\ -d\partial_y v(t, x, 0) = \mu u - \nu v(t, x, 0), & t > 0, x \in \mathbb{R}. \end{cases} \quad (1.12)$$

We assume that the reaction term $f(x, v)$ depends on the x variable in a periodic fashion. As a simple example, f may be of the type $f(x, v) = a(x)v(1-v)$ in which the periodic coefficient $a(x)$ can be interpreted as an effective birth rate of the population. In models of biological invasions, the heterogeneity may be a consequence of the presence of highly differentiated zones such as forests, rivers, grasslands, roads, villages, etc., where the species in consideration may tend to reproduce or die with different rates from one place to another. Therefore, it is a fundamental problem to understand how heterogeneity influences the characteristics of front propagation such as front speeds and front profiles.

Throughout this work, we assume that $f: \mathbb{R} \times \mathbb{R}_+ \rightarrow \mathbb{R}$ is of class $C^{1,\delta}$ in (x, v) (with $0 < \delta < 1$) and C^2 in v , L -periodic in x , and satisfies the KPP assumption:

$$f(\cdot, 0) \equiv 0 \equiv f(\cdot, 1), \quad 0 < f(\cdot, v) \leq f_v(\cdot, 0)v \text{ for } v \in (0, 1), \quad f(\cdot, v) < 0 \text{ for } v \in (1, +\infty).$$

1. General introduction

Define $M := \max_{[0,L]} f_v(x, 0)$ and $m := \min_{[0,L]} f_v(x, 0)$. Then $M \geq m > 0$. We further assume that

$$\forall x \in \mathbb{R}, v \mapsto \frac{f(x, v)}{v} \text{ is decreasing in } v > 0.$$

In what follows, as far as the Cauchy problem is concerned, we always assume that the initial condition (u_0, v_0) is nonnegative, bounded and continuous.

We now present our results. As a first step, we focus on the following truncated problem with an imposed Dirichlet upper boundary condition:

$$\begin{cases} \partial_t u - D\partial_{xx}u = \nu v(t, x, 0) - \mu u, & t > 0, x \in \mathbb{R}, \\ \partial_t v - d\Delta v = f(x, v), & t > 0, (x, y) \in \Omega_R, \\ -d\partial_y v(t, x, 0) = \mu u - \nu v(t, x, 0), & t > 0, x \in \mathbb{R}, \\ v(t, x, R) = 0, & t > 0, x \in \mathbb{R}, \end{cases} \quad (1.13)$$

in which $\Omega_R := \{(x, y) \in \mathbb{R} : 0 < y < R\}$ denotes a truncated domain with width R sufficiently large. In fact, the width R of the strip plays a crucial role in long time behavior of the corresponding Cauchy problem (1.13) due to the zero Dirichlet upper boundary condition. A natural explanation, from the biological point of view, is that if the width of the strip is not sufficiently large, the species may finally extinct because of the effect of unfavorable Dirichlet condition on the upper boundary. Therefore, we shall give a sufficient condition on R such that the species can persist successfully. Here is our statement.

Theorem 1.3. *If*

$$m > \frac{d\pi^2}{4R^2}, \quad (1.14)$$

then (1.13) admits a unique nontrivial nonnegative stationary solution (U_R, V_R) , which is L -periodic in x . Moreover, let (u, v) be the solution of (1.13) with a nonnegative, bounded and continuous initial datum $(u_0, v_0) \not\equiv (0, 0)$, then

$$\lim_{t \rightarrow +\infty} (u(t, x), v(t, x, y)) = (U_R(x), V_R(x, y)) \text{ locally uniformly in } (x, y) \in \bar{\Omega}_R. \quad (1.15)$$

Remark 1.4. In particular, when the environment is homogeneous, i.e. $f(x, v) \equiv f(v)$, R should satisfy $4R^2 f'(0) > d\pi^2$, which coincides with the condition in [152]. Let $R_* > 0$ be such that $m = \frac{d\pi^2}{4R_*^2}$. For any $R > R_0 := 2R_*$, (1.14) is satisfied and there also holds $m = \frac{d\pi^2}{R_0^2} > \frac{d\pi^2}{R^2}$. Throughout the work, as far as the truncated problem is concerned, it is not restrictive to assume that $R > R_0$ (since our strategy is to take $R \rightarrow +\infty$ to consider (1.12)), which will be convenient to prove the positivity of the asymptotic spreading speed c_R^* for problem (1.13).

Let (U_R, V_R) be the unique nontrivial nonnegative stationary solution of (1.13) in the

sequel. We are now in a position to investigate spreading properties of solutions to (1.13) in $\overline{\Omega}_R$, which is based on dynamical system method and principal eigenvalue theory.

We first consider the following eigenvalue problem in the strip $\overline{\Omega}_R$:

$$\begin{cases} -D\phi'' + 2D\alpha\phi' + (-D\alpha^2 + \mu)\phi - \nu\psi(x, 0) = \sigma\phi, & x \in \mathbb{R}, \\ -d\Delta\psi + 2d\alpha\partial_x\psi - (d\alpha^2 + f_v(x, 0))\psi = \sigma\psi, & (x, y) \in \Omega_R, \\ -d\partial_y\psi(x, 0) + \nu\psi(x, 0) - \mu\phi = 0, & x \in \mathbb{R}, \\ \psi(x, R) = 0, & x \in \mathbb{R}, \\ \phi, \psi \text{ are } L\text{-periodic with respect to } x. \end{cases} \quad (1.16)$$

The compactness of the domain allows us to apply the classical Krein-Rutman theory which provides the existence of the principal eigenvalue $\lambda_R(\alpha) \in \mathbb{R}$ and the associated unique (up to multiplication by some constant) positive principal eigenfunction pair $(P_{\alpha,R}(x), Q_{\alpha,R}(x, y)) \in C^3(\mathbb{R}) \times C^3(\overline{\Omega}_R)$ for each $\alpha \in \mathbb{R}$.

Theorem 1.5. *Let (U_R, V_R) be the unique nontrivial nonnegative stationary solution of (1.13) obtained in Theorem 1.3 and let (u, v) be the solution of (1.13) with a nontrivial continuous initial datum (u_0, v_0) with $(0, 0) \leq (u_0, v_0) \leq (U_R, V_R)$ in $\overline{\Omega}_R$. Then there exists $c_R^* > 0$ given by*

$$c_R^* = \inf_{\alpha > 0} \frac{-\lambda_R(\alpha)}{\alpha},$$

called the asymptotic spreading speed, such that the following statements are valid:

(i) *If (u_0, v_0) is compactly supported, then for any $c > c_R^*$, there holds*

$$\lim_{t \rightarrow +\infty} \sup_{|x| \geq ct, y \in [0, R]} |(u(t, x), v(t, x, y))| = 0,$$

(ii) *For any $0 < c < c_R^*$, there holds*

$$\lim_{t \rightarrow +\infty} \sup_{|x| \leq ct, y \in [0, R]} |(u(t, x), v(t, x, y)) - (U_R(x), V_R(x, y))| = 0.$$

Before stating the result of pulsating fronts for (1.13), let us give the definition of pulsating traveling fronts in the strip $\overline{\Omega}_R$ for clarity.

Definition 1.6. *A rightward pulsating front of (1.13) connecting $(U_R(x), V_R(x, y))$ to $(0, 0)$ with effective mean speed $c \in \mathbb{R}_+$ is a time-global classical solution $(u(t, x), v(t, x, y)) = (\phi_R(x - ct, x), \psi_R(x - ct, x, y))$ of (1.13) such that the following periodicity property holds:*

$$u\left(t + \frac{k}{c}, x\right) = u(t, x - k), \quad v\left(t + \frac{k}{c}, x, y\right) = v(t, x - k, y) \quad \forall k \in LZ, \quad \forall t \in \mathbb{R}, \quad \forall (x, y) \in \overline{\Omega}_R. \quad (1.17)$$

1. General introduction

Moreover, the profile $(\phi_R(s, x), \psi_R(s, x, y))$ satisfies

$$\begin{cases} \phi_R(-\infty, x) = U_R(x), \quad \phi_R(+\infty, x) = 0 \text{ uniformly in } x \in \mathbb{R}, \\ \psi_R(-\infty, x, y) = V_R(x, y), \quad \psi_R(+\infty, x, y) = 0 \text{ uniformly in } (x, y) \in \overline{\Omega}_R, \end{cases} \quad (1.18)$$

with $(\phi_R(s, x), \psi_R(s, x, y))$ being continuous in $s \in \mathbb{R}$.

Similarly, a leftward pulsating front of (1.13) connecting $(0, 0)$ to $(U_R(x), V_R(x, y))$ with effective mean speed $c \in \mathbb{R}_+$ is a time-global classical solution $(\tilde{u}(t, x), \tilde{v}(t, x, y)) = (\phi_R(x + ct, x), \psi_R(x + ct, x, y))$ of (1.13) such that the following periodicity property holds:

$$\tilde{u}\left(t + \frac{k}{c}, x\right) = \tilde{u}(t, x + k), \quad \tilde{v}\left(t + \frac{k}{c}, x, y\right) = \tilde{v}(t, x + k, y) \quad \forall k \in L\mathbb{Z}, \quad \forall t \in \mathbb{R}, \quad \forall (x, y) \in \overline{\Omega}_R.$$

Moreover, the profile $(\phi_R(s, x), \psi_R(s, x, y))$ satisfies

$$\begin{cases} \phi_R(-\infty, x) = 0, \quad \phi_R(+\infty, x) = U_R(x) \text{ uniformly in } x \in \mathbb{R}, \\ \psi_R(-\infty, x, y) = 0, \quad \psi_R(+\infty, x, y) = V_R(x, y) \text{ uniformly in } (x, y) \in \overline{\Omega}_R, \end{cases}$$

with $(\phi_R(s, x), \psi_R(s, x, y))$ being continuous in $s \in \mathbb{R}$.

Theorem 1.7. *Let c_R^* be given as in Theorem 1.5. Then the following statements are valid:*

- (i) *Problem (1.13) admits a rightward pulsating front connecting $(U_R(x), V_R(x, y))$ to $(0, 0)$ with wave profile $(\phi_R(s, x), \psi_R(s, x, y))$ being continuous and decreasing in s if and only if $c \geq c_R^*$.*
- (ii) *Problem (1.13) admits a leftward pulsating front connecting $(0, 0)$ to $(U_R(x), V_R(x, y))$ with wave profile $(\phi_R(s, x), \psi_R(s, x, y))$ being continuous and increasing in s if and only if $c \geq c_R^*$.*

Having the principal eigenvalue $\lambda_R(\alpha)$ for eigenvalue problem (1.16) in hand, we construct in Section 3.5.1 the *generalized* principal eigenvalue $\lambda(\alpha)$ by passing to the limit $R \rightarrow +\infty$ in $\lambda_R(\alpha)$ for each $\alpha \in \mathbb{R}$, and show that there exists a positive and L -periodic (in x) solution (P_α, Q_α) of the following generalized eigenvalue problem in the half-plane:

$$\begin{cases} -DP_\alpha'' + 2D\alpha P_\alpha' + (-D\alpha^2 + \mu)P_\alpha - \nu Q_\alpha(x, 0) = \lambda(\alpha)P_\alpha, & x \in \mathbb{R}, \\ -d\Delta Q_\alpha + 2d\alpha\partial_x Q_\alpha - (d\alpha^2 + f_v(x, 0))Q_\alpha = \lambda(\alpha)Q_\alpha, & (x, y) \in \Omega, \\ -d\partial_y Q_\alpha(x, 0) + \nu Q_\alpha(x, 0) - \mu P_\alpha = 0, & x \in \mathbb{R}, \\ P_\alpha, Q_\alpha \text{ are } L\text{-periodic with respect to } x. \end{cases} \quad (1.19)$$

We call (P_α, Q_α) the generalized principal eigenfunction pair associated with $\lambda(\alpha)$.

We are now in a position to give the spreading result in the half plane.

Theorem 1.8. *Let (u, v) be the solution of (1.12) with a nonnegative, bounded and continuous initial datum $(u_0, v_0) \neq (0, 0)$. Then there exists $c^* > 0$ defined by*

$$c^* = \inf_{\alpha > 0} \frac{-\lambda(\alpha)}{\alpha},$$

called the asymptotic spreading speed, such that the following statements are valid:

(i) *If (u_0, v_0) is compactly supported, then for any $c > c^*$, for any $A > 0$,*

$$\lim_{t \rightarrow +\infty} \sup_{|x| \geq ct, 0 \leq y \leq A} |(u(t, x), v(t, x, y))| = 0,$$

(ii) *If $(u_0, v_0) < (\nu/\mu, 1)$, then, for any $0 < c < c^*$, for any $A > 0$,*

$$\lim_{t \rightarrow +\infty} \sup_{|x| \leq ct, 0 \leq y \leq A} |(u(t, x), v(t, x, y)) - (\nu/\mu, 1)| = 0. \quad (1.20)$$

In the proof of Theorem 1.8, the generalized principal eigenfunction pair (P_α, Q_α) of (1.19) associated with $\lambda(\alpha)$ will play a crucial role in getting the upper bound for the spreading result. The lower bound follows from spreading results in the truncated domain via an asymptotic method.

Next, we state the concept of pulsating fronts for problem (1.12) in the half-plane Ω .

Definition 1.9. *A rightward pulsating front of (1.12) connecting $(\nu/\mu, 1)$ and $(0, 0)$ with effective mean speed $c \in \mathbb{R}_+$ is a time-global classical solution $(u(t, x), v(t, x, y)) = (\phi(x - ct, x), \psi(x - ct, x, y))$ of (1.12) such that the following periodicity property holds:*

$$u(t + \frac{k}{c}, x) = u(t, x - k), \quad v(t + \frac{k}{c}, x, y) = v(t, x - k, y) \quad \forall k \in L\mathbb{Z}, \quad \forall t \in \mathbb{R}, \quad \forall (x, y) \in \bar{\Omega}.$$

Moreover, the profile $(\phi(s, x), \psi(s, x, y))$ satisfies

$$\begin{cases} \phi(-\infty, x) = \nu/\mu, \quad \phi(+\infty, x) = 0 \text{ uniformly in } x \in \mathbb{R}, \\ \psi(-\infty, x, y) = 1, \quad \psi(+\infty, x, y) = 0 \text{ uniformly in } x \in \mathbb{R}, \text{ locally uniformly in } y \in [0, +\infty), \end{cases} \quad (1.21)$$

with $(\phi(s, x), \psi(s, x, y))$ being continuous in $s \in \mathbb{R}$.

Similarly, a leftward pulsating front of (1.12) connecting $(0, 0)$ and $(\nu/\mu, 1)$ with effective mean speed $c \in \mathbb{R}_+$ is a time-global classical solution $(u(t, x), v(t, x, y)) = (\phi(x + ct, x), \psi(x + ct, x, y))$ of (1.12) such that the following periodicity property holds:

$$\tilde{u}(t + \frac{k}{c}, x) = \tilde{u}(t, x + k), \quad \tilde{v}(t + \frac{k}{c}, x, y) = \tilde{v}(t, x + k, y) \quad \forall k \in L\mathbb{Z}, \quad \forall t \in \mathbb{R}, \quad \forall (x, y) \in \bar{\Omega}.$$

1. General introduction

Moreover, the profile $(\phi(s, x), \psi(s, x, y))$ satisfies

$$\begin{cases} \phi(-\infty, x) = \nu/\mu, \quad \phi(+\infty, x) = 0 \text{ uniformly in } x \in \mathbb{R}, \\ \psi(-\infty, x, y) = 1, \quad \psi(+\infty, x, y) = 0 \text{ uniformly in } x \in \mathbb{R}, \text{ locally uniformly in } y \in [0, +\infty), \end{cases}$$

with $(\phi(s, x), \psi(s, x, y))$ being continuous in $s \in \mathbb{R}$.

Based on Theorem 1.7 and an asymptotic method, we can show:

Theorem 1.10. *Let c^* be defined as in Theorem 1.8. Then the following statements are valid:*

- (i) *Problem (1.12) admits a rightward pulsating front connecting $(\nu/\mu, 1)$ to $(0, 0)$ with wave profile $(\phi(s, x), \psi(s, x, y))$ being continuous and decreasing in s if and only if $c \geq c^*$.*
- (ii) *Problem (1.12) admits a leftward pulsating front connecting $(0, 0)$ to $(\nu/\mu, 1)$ with wave profile $(\phi(s, x), \psi(s, x, y))$ being continuous and increasing in s if and only if $c \geq c^*$.*

On some model problem for the propagation of interacting species in a special environment

In this subsection, we consider an elliptic problem where the living space of our species consists in a field and one or several roads that we will assume to be unidimensional. We will also assume the roads to be straight but several extensions can be addressed very easily with our approach. On each domain -field or road- we will consider nonlinear diffusion equations which include for instance the Fisher-KPP types.

Let Ω_ℓ be the open set of \mathbb{R}^2 , defined for $\ell, L > 0$ as

$$\Omega_\ell = (-\ell, \ell) \times (0, L).$$

We denote by Γ_0 the part of the boundary of Ω_ℓ located on the x_1 -axis i.e.

$$\Gamma_0 = (-\ell, \ell) \times \{0\}$$

and by Γ_1 the rest of the boundary that is to say

$$\Gamma_1 = \partial\Omega_\ell \setminus \Gamma_0.$$

When convenient we will identify Γ_0 to $(-\ell, \ell)$. In this setting Ω_ℓ stands for a field and Γ_0 for a portion of a road.

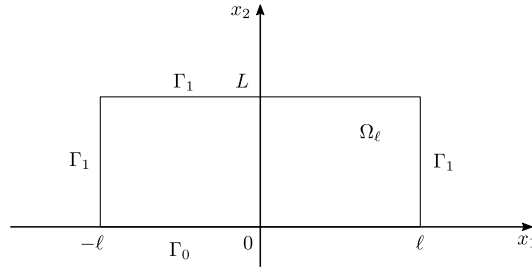

Figure 1: The domain Ω_ℓ for one-road problem

Set

$$V = \{v \in H^1(\Omega_\ell) \mid v = 0 \text{ on } \Gamma_1\}.$$

We would like to find a solution to the problem

$$\begin{cases} -D\Delta v = f(v) \text{ in } \Omega_\ell, \\ v = 0 \text{ on } \Gamma_1, \quad D\frac{\partial v}{\partial n} = \mu u - \nu v \text{ on } \Gamma_0, \\ -D'u'' + \mu u = g(u) + \nu v \text{ on } \Gamma_0, \\ u = 0 \text{ on } \partial\Gamma_0 = \{-\ell, \ell\}. \end{cases}$$

(n denotes the outward unit normal to Ω_ℓ).

In the weak form we would like to find a couple (u, v) such that

$$\begin{cases} (u, v) \in H_0^1(\Gamma_0) \times V, \\ \int_{\Omega_\ell} D\nabla v \cdot \nabla \varphi \, dx + \int_{\Gamma_0} \nu v(x_1, 0) \varphi \, dx_1 \\ = \int_{\Omega_\ell} f(v) \varphi \, dx + \int_{\Gamma_0} \mu u \varphi \, dx_1 \quad \forall \varphi \in V, \\ \int_{\Gamma_0} D'u' \psi' + \mu u \psi \, dx_1 = \int_{\Gamma_0} \nu v(x_1, 0) \psi \, dx_1 \\ + \int_{\Gamma_0} g(u) \psi \, dx_1 \quad \forall \psi \in H_0^1(\Gamma_0). \end{cases} \quad (1.22)$$

Here we assume that

$$D, D', m, \mu, \nu \text{ are positive constants,}$$

such that

$$m \geq \frac{\nu}{\mu}. \quad (1.23)$$

Assume that f, g are Lipschitz continuous functions i.e. there are $L_f, L_g > 0$ such that

$$|f(x) - f(y)| \leq L_f |x - y|, \quad |g(x) - g(y)| \leq L_g |x - y| \quad \forall x, y \in \mathbb{R}. \quad (1.24)$$

1. General introduction

Note that this implies that for $\lambda \geq L_f$ (respectively $\eta \geq L_g$) the functions

$$x \rightarrow \lambda x - f(x), \quad \eta x - g(x) \quad (1.25)$$

are nondecreasing. In addition we will assume

$$f(0) = f(1) = 0, \quad f > 0 \text{ on } (0, 1), \quad f \leq 0 \text{ on } (1, +\infty). \quad (1.26)$$

$$g(0) = 0, \quad g(m) \leq 0. \quad (1.27)$$

We are interested in finding a nontrivial solution to the problem (1.22).

We denote by $\lambda_1 = \lambda_1(\Omega_\ell)$ the first eigenvalue of the Dirichlet problem in Ω_ℓ and by φ_1 the corresponding first eigenfunction positive and normalised. More precisely (λ_1, φ_1) is such that

$$\begin{cases} -\Delta\varphi_1 = \lambda_1\varphi_1 & \text{in } \Omega_\ell, \\ \varphi_1 = 0 & \text{on } \partial\Omega_\ell, \\ \varphi_1(0, \frac{L}{2}) = 1. \end{cases} \quad (1.28)$$

We suppose that for $s > 0$ small enough one has

$$\lambda_1 \leq \frac{f(s)}{Ds}. \quad (1.29)$$

Suppose that

$$\frac{f(s)}{s} \text{ is decreasing on } (0, +\infty). \quad (1.30)$$

Theorem 1.11. *Suppose that (1.23)-(1.27), (1.29), (1.30) hold, then the problem (1.22) admits a nontrivial solution.*

Next, we consider some extension in the case of a two-road problem which consists of three coupled equations with two interaction conditions on the upper- and lower- boundaries. To be more precise, we set

$$\Gamma'_0 = (-\ell, \ell) \times \{L\}, \quad \Gamma_1 = \partial\Omega_\ell \setminus \{\Gamma_0 \cup \Gamma'_0\},$$

$$V = \{v \in H^1(\Omega_\ell) \mid v = 0 \text{ on } \Gamma_1\},$$

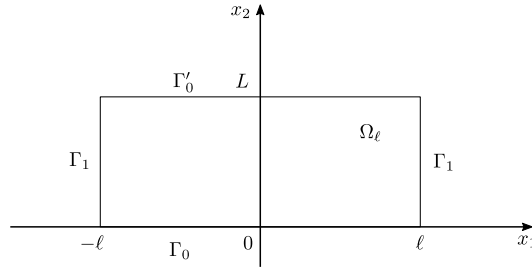
 Figure 2: The domain Ω_ℓ for two-road problem

We consider the problem of finding a (u, v, w) solution to

$$\left\{ \begin{array}{l} (u, v, w) \in H_0^1(\Gamma_0) \times V \times H_0^1(\Gamma'_0), \\ \int_{\Omega_\ell} D \nabla v \cdot \nabla \varphi \, dx + \int_{\Gamma_0} \nu v(x_1, 0) \varphi \, dx_1 + \int_{\Gamma'_0} \nu v(x_1, L) \varphi \, dx_1 \\ = \int_{\Omega_\ell} f(v) \varphi \, dx + \int_{\Gamma_0} \mu u \varphi \, dx_1 + \int_{\Gamma'_0} \mu' w \varphi \, dx_1 \quad \forall \varphi \in V, \\ \int_{\Gamma_0} D' u' \psi' + \mu u \psi \, dx_1 \\ = \int_{\Gamma_0} \nu v(x_1, 0) \psi \, dx_1 + \int_{\Gamma_0} g(u) \psi \, dx_1 \quad \forall \psi \in H_0^1(\Gamma_0), \\ \int_{\Gamma'_0} D'' w' \phi' + \mu' w \phi \, dx_1 \\ = \int_{\Gamma'_0} \nu' v(x_1, L) \phi \, dx_1 + \int_{\Gamma'_0} h(w) \phi \, dx_1 \quad \forall \phi \in H_0^1(\Gamma'_0). \end{array} \right. \quad (1.31)$$

Here we assume that

$$D, D', D'', \mu, \nu, \mu', \nu' \text{ are positive constants,}$$

f, g, h are Lipschitz continuous functions with Lipschitz constants L_f, L_g, L_h respectively (Cf. (1.24)), which implies that for $\lambda \geq L_f, \eta \geq L_g$ and $\xi \geq L_h$ the functions

$$x \rightarrow \lambda x - f(x), \quad \eta x - g(x), \quad \xi x - h(x)$$

are nondecreasing. We will suppose that f satisfies (1.26) and that

$$g(0) = 0, \quad h(0) = 0.$$

Since Γ_0 and Γ'_0 are playing exactly identical roles there is no loss of generality in assuming for instance

$$\frac{\mu}{\nu} \geq \frac{\mu'}{\nu'}.$$

Then for

$$m \geq \frac{\nu}{\mu}, \quad m' = \frac{\nu'}{\mu'} \frac{\mu}{\nu} m,$$

1. General introduction

we will assume

$$g(m) \leq 0, \quad h(m') \leq 0.$$

Then we have:

Theorem 1.12. *Under the assumptions above the problem (1.31) admits a nontrivial solution.*

Finally, we address the case of an unbounded setting for the one-road problem. For convenience we will denote by V_ℓ the space V defined above. Similarly we will indicate the dependence in ℓ for Γ_0 , i.e.

$$\Gamma_0 = \Gamma_0^\ell = (-\ell, \ell) \times \{0\}.$$

When convenient we will set $I_\ell = (-\ell, \ell)$. In addition, we set

$$\Omega_\infty = \mathbb{R} \times (0, L), \quad \Gamma_0^\infty = \mathbb{R} \times \{0\}, \quad \Gamma_1^\infty = \mathbb{R} \times \{L\},$$

$$V_\infty = \{v \in H_{loc}^1(\overline{\Omega_\infty}) \mid v = 0 \text{ on } \Gamma_1^\infty\},$$

where

$$H_{loc}^1(\overline{\Omega_\infty}) = \{v \mid v \in H^1(\Omega_{\ell_0}) \forall \ell_0 > 0\}.$$

Then we have

Theorem 1.13. *Suppose that (1.23), (1.24), (1.26), (1.27), (1.30) hold and that*

$$\frac{f(s)}{Ds} > \left(\frac{\pi}{L}\right)^2, \tag{1.32}$$

then under the assumptions above there exists (u, v) nontrivial solution to

$$\begin{cases} (u, v) \in H_0^1(\Gamma_0^\infty) \times V_\infty, \\ \int_{\Omega_{\ell_0}} D\nabla v \cdot \nabla \varphi \, dx + \int_{I_{\ell_0}} \nu v(x_1, 0) \varphi \, dx_1 \\ = \int_{\Omega_{\ell_0}} f(v) \varphi \, dx + \int_{I_{\ell_0}} \mu u \varphi \, dx_1 \quad \forall \varphi \in V_{\ell_0}, \quad \forall \ell_0, \\ \int_{I_{\ell_0}} D'u' \psi' + \mu u \psi \, dx_1 \\ = \int_{I_{\ell_0}} \nu v(x_1, 0) \psi \, dx_1 + \int_{I_{\ell_0}} g(u) \psi \, dx_1 \quad \forall \psi \in H_0^1(I_{\ell_0}), \quad \forall \ell_0. \end{cases}$$

(We identify Γ_0^∞ with \mathbb{R} . Recall that $I_\ell = (-\ell, \ell)$).

1.3 Reaction-diffusion fronts in funnel-shaped domains

This section is devoted to the study of propagation phenomena of time-global (entire) bounded solutions $u = u(t, x)$ of reaction-diffusion equations of the type

$$\begin{cases} u_t = \Delta u + f(u), & t \in \mathbb{R}, x \in \overline{\Omega}, \\ \nu \cdot \nabla u = 0, & t \in \mathbb{R}, x \in \partial\Omega, \end{cases} \quad (1.33)$$

in certain unbounded smooth domains $\Omega \subset \mathbb{R}^N$ with $N \geq 2$. Here u_t stands for $\frac{\partial u}{\partial t}$, and $\nu = \nu(x)$ is the outward unit normal on the boundary $\partial\Omega$, that is, Neumann boundary conditions are imposed on $\partial\Omega$. Equations of type (1.33) arise especially in the fields of population dynamics, mathematical ecology, physics and also medicine and biology. The function u typically stands for the temperature or the concentration of a species. It is assumed to be bounded, then with no loss of generality we suppose that it takes values in $[0, 1]$. The reaction term f is assumed to be of class $C^{1,1}([0, 1], \mathbb{R})$ and such that

$$f(0) = f(1) = 0, \quad f'(0) < 0, \quad f'(1) < 0, \quad (1.34)$$

which means that both 0 and 1 are stable zeros of f . Moreover, we assume that f is of the bistable type with positive mass, that is, there exists $\theta \in (0, 1)$ such that

$$f < 0 \text{ in } (0, \theta), \quad f > 0 \text{ in } (\theta, 1), \quad f'(\theta) > 0, \quad \int_0^1 f(s) ds > 0. \quad (1.35)$$

The fact that f has a positive mass over $[0, 1]$ means the state 1 is in some sense more stable than 0. A typical example of a function f satisfying (1.34)–(1.35) is the cubic nonlinearity $f(u) = u(1-u)(u-\theta)$ with $\theta \in (0, 1/2)$. For mathematical purposes, we extend f in $\mathbb{R} \setminus [0, 1]$ to a $C^{1,1}(\mathbb{R}, \mathbb{R})$ function as follows: $f(s) = f'(0)s$ for $s < 0$, and $f(s) = f'(1)(s-1)$ for $s > 1$.

One main question of interest for the solutions of (1.33) is the description of their dynamical properties as $t \rightarrow \pm\infty$. The answer to this question depends strongly on the geometry of the underlying domain Ω . In the one-dimensional real line \mathbb{R} , a prominent role is played by a class of particular solutions, namely the traveling fronts. More precisely, with assumptions (1.34)–(1.35) above, (1.33) in \mathbb{R} admits a unique planar traveling front $\phi(x - ct)$ solving

$$\begin{cases} \phi'' + c\phi' + f(\phi) = 0 \text{ in } \mathbb{R}, \\ \phi(-\infty) = 1, \quad \phi(+\infty) = 0, \quad 0 < \phi < 1 \text{ in } \mathbb{R}, \quad \phi(0) = \theta, \end{cases} \quad (1.36)$$

see, for instance, [9, 76, 106]. The profile ϕ is then a connection between the stable steady states 1 and 0. Moreover, $\phi' < 0$ in \mathbb{R} , and c is positive since f has a positive integral over $[0, 1]$. The traveling front $\phi(x - ct)$ is invariant in the moving frame with speed c , and it attracts as $t \rightarrow +\infty$ a large class of front-like solutions of the associated Cauchy problem,

1. General introduction

see [76]. Throughout this section, we assume that f satisfies (1.34)–(1.35) and that ϕ and $c > 0$ are uniquely defined as in (1.36).

The domain $\Omega \subset \mathbb{R}^N$ considered here is made up of a straight part and a conical part: we assume that the left (say, with respect to the direction x_1) part of Ω , namely $\Omega^- = \Omega \cap \{x \in \mathbb{R}^N : x_1 \leq 0\}$, is a straight half-cylinder in the direction $-x_1$ with cross section of radius $R > 0$, while the right part, namely $\Omega^+ = \Omega \setminus \Omega^-$, is a cone-like set with respect to the x_1 -axis and with opening angle $\alpha \geq 0$. More precisely, we assume that Ω is rotationally invariant with respect to the x_1 -axis, that is,

$$\Omega = \{x = (x_1, x') \in \mathbb{R}^N : x_1 \in \mathbb{R}, |x'| < h(x_1)\}, \quad (1.37)$$

where $|\cdot|$ denotes the Euclidean norm, and that $h : \mathbb{R} \rightarrow \mathbb{R}^+$ is a $C^{2,\beta}(\mathbb{R})$ (with $0 < \beta < 1$) function satisfying the following properties:

$$\begin{cases} 0 \leq h' \leq \tan \alpha \text{ in } \mathbb{R}, & \text{for some angle } \alpha \in [0, \pi/2), \\ h = R \text{ in } (-\infty, 0], & \text{for some radius } R > 0, \\ h(x_1) = x_1 \tan \alpha \text{ in } [L \cos \alpha, +\infty), & \text{for some } L > R, \end{cases} \quad (1.38)$$

see Figure 3.

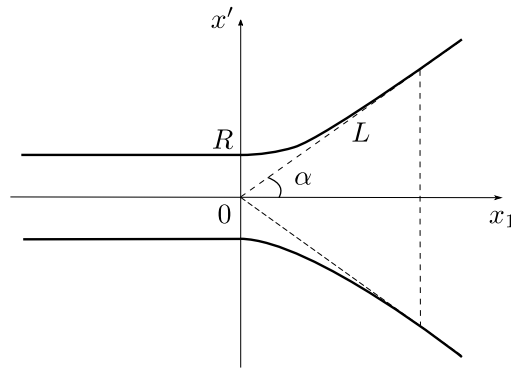

Figure 3: Schematic figure of the domain $\Omega_{R,\alpha}$ for $R > 0$ and $\alpha \in (0, \pi/2)$.

Such a domain is then called “funnel-shaped”. In the particular limit case $\alpha = 0$, the domain Ω amounts to a straight cylinder in \mathbb{R}^N with cross section of radius R . Notice that, when $\alpha > 0$, the cross section is unbounded as $x_1 \rightarrow +\infty$. To emphasize the dependence on R and α , we will also use the notation $\Omega_{R,\alpha}$ for convenience. The domains $\Omega_{R,\alpha}$ are not uniquely defined by (1.37)–(1.38), and they also depend on the parameter L in (1.38), but only the parameters $R > 0$ and $\alpha \in [0, \pi/2)$ will play an important role in our study (except in Theorem 1.22 below). Other domains which have a globally similar shape, but may be only asymptotically straight in the left part or asymptotically conical in the right

part could have been considered, at the expense of less precise estimates and more technical calculations. Since the domains satisfying (1.37)–(1.38) lead to a variety of interesting and non-trivial phenomena, we restrict ourselves to (1.37)–(1.38) throughout this work.

If the domain is a straight cylinder in the direction x_1 (this happens in the case $\alpha = 0$), then the planar front $\phi(x_1 - ct)$ given by (1.36) solves (1.33) (furthermore, up to translation, any transition front connecting 0 and 1 in the sense of Definition 1.14 below is equal to that front, see [88, 92]). Here a domain $\Omega = \Omega_{R,\alpha}$ satisfying (1.37)–(1.38) is straight in its left part only, and the standard planar front $\phi(x_1 - ct)$ does not fulfill the Neumann boundary conditions when $\alpha > 0$. But it is still very natural to consider solutions of (1.33) behaving in the past like the planar front $\phi(x_1 - ct)$ coming from the left part of the domain, and to investigate the outcome of these solutions as they move into the right part of the domain. More precisely, we consider time-global solutions of (1.33) emanating from the planar front $\phi(x_1 - ct)$, that is,

$$u(t, x) - \phi(x_1 - ct) \rightarrow 0 \text{ as } t \rightarrow -\infty, \text{ uniformly with respect to } x \in \overline{\Omega} \quad (1.39)$$

(notice that, in the right part Ω^+ of Ω , this condition simply means that $u(t, \cdot) \rightarrow 0$ as $t \rightarrow -\infty$ uniformly in $\overline{\Omega^+}$). We will see that such solutions exist and are unique, and the main goal of this work is to study their behavior as $t \rightarrow +\infty$, in terms of the parameters R and α .

To describe the dynamical properties of the solutions of (1.33) satisfying (1.39), we use the unifying notions of generalized traveling fronts, called transition fronts, introduced in [18, 19]. In order to recall these notions of transition fronts and that of global mean speed, let us introduce some notations. Let d_Ω be the geodesic distance in $\overline{\Omega}$ (with respect to the Euclidean distance d in \mathbb{R}^N). For any two subsets A and B of $\overline{\Omega}$, we set

$$d_\Omega(A, B) = \inf \{d_\Omega(x, y) : (x, y) \in A \times B\},$$

and $d_\Omega(x, A) = d_\Omega(\{x\}, A)$ for $x \in \overline{\Omega}$. We also use similar definitions with d , instead of d_Ω , for the Euclidean distance between subsets of \mathbb{R}^N . Consider now two families $(\Omega_t^-)_{t \in \mathbb{R}}$ and $(\Omega_t^+)_{t \in \mathbb{R}}$ of open non-empty subsets of Ω such that

$$\forall t \in \mathbb{R}, \begin{cases} \Omega_t^- \cap \Omega_t^+ = \emptyset, & \partial\Omega_t^- \cap \Omega = \partial\Omega_t^+ \cap \Omega =: \Gamma_t \neq \emptyset, & \Omega_t^- \cup \Gamma_t \cup \Omega_t^+ = \Omega, \\ \sup \{d_\Omega(x, \Gamma_t) : x \in \Omega_t^+\} = \sup \{d_\Omega(x, \Gamma_t) : x \in \Omega_t^-\} = +\infty \end{cases} \quad (1.40)$$

and

$$\begin{cases} \inf \{ \sup \{d_\Omega(y, \Gamma_t) : y \in \Omega_t^+, d_\Omega(y, x) \leq r\} : t \in \mathbb{R}, x \in \Gamma_t \} \rightarrow +\infty \\ \inf \{ \sup \{d_\Omega(y, \Gamma_t) : y \in \Omega_t^-, d_\Omega(y, x) \leq r\} : t \in \mathbb{R}, x \in \Gamma_t \} \rightarrow +\infty \end{cases} \text{ as } r \rightarrow +\infty. \quad (1.41)$$

1. General introduction

Condition (1.41) says that for any $M > 0$, there is $r_M > 0$ such that for every $t \in \mathbb{R}$ and $x \in \Gamma_t$, there are $y^\pm = y_{t,x}^\pm \in \mathbb{R}^N$ such that

$$y^\pm \in \Omega_t^\pm, \quad d_\Omega(x, y^\pm) \leq r_M \text{ and } d_\Omega(y^\pm, \Gamma_t) \geq M. \quad (1.42)$$

In other words, any point on Γ_t is not too far from the centers of two large balls (in the sense of the geodesic distance in $\bar{\Omega}$) included in Ω_t^- and Ω_t^+ , this property being uniform with respect to t and to the point on Γ_t . Moreover, in order to avoid interfaces with infinitely many twists, the sets Γ_t are assumed to be included in finitely many graphs: there is an integer $n \geq 1$ such that, for each $t \in \mathbb{R}$, there are n open subsets $\omega_{i,t} \subset \mathbb{R}^{N-1}$ (for $1 \leq i \leq n$), n continuous maps $\psi_{i,t} : \omega_{i,t} \rightarrow \mathbb{R}$ and n rotations $R_{i,t}$ of \mathbb{R}^N with

$$\Gamma_t \subset \bigcup_{1 \leq i \leq n} R_{i,t}(\{x = (x', x_N) \in \mathbb{R}^N : x' \in \omega_{i,t}, x_N = \psi_{i,t}(x')\}). \quad (1.43)$$

Definition 1.14 ([18, 19]). *For problem (1.33), a transition front connecting 1 and 0 is a classical solution $u : \mathbb{R} \times \bar{\Omega} \rightarrow (0, 1)$ for which there exist some sets $(\Omega_t^\pm)_{t \in \mathbb{R}}$ and $(\Gamma_t)_{t \in \mathbb{R}}$ satisfying (1.40)–(1.43) and for every $\varepsilon > 0$ there exists $M_\varepsilon > 0$ such that*

$$\begin{cases} \forall t \in \mathbb{R}, \forall x \in \bar{\Omega}_t^+, \quad d_\Omega(x, \Gamma_t) \geq M_\varepsilon \implies u(t, x) \geq 1 - \varepsilon, \\ \forall t \in \mathbb{R}, \forall x \in \bar{\Omega}_t^-, \quad d_\Omega(x, \Gamma_t) \geq M_\varepsilon \implies u(t, x) \leq \varepsilon. \end{cases} \quad (1.44)$$

Furthermore, u is said to have a global mean speed $\gamma \in [0, +\infty)$ if

$$\frac{d_\Omega(\Gamma_t, \Gamma_s)}{|t - s|} \rightarrow \gamma \text{ as } |t - s| \rightarrow +\infty.$$

This definition has been shown in [18, 19, 92] to cover and unify all classical cases of traveling fronts in various situations. Condition (1.44) means that the transition between the steady states 1 and 0 takes place in some uniformly-bounded-in-time neighborhoods of Γ_t . For a given transition front connecting 1 and 0, the families $(\Omega_t^\pm)_{t \in \mathbb{R}}$ and $(\Gamma_t)_{t \in \mathbb{R}}$ satisfying (1.40)–(1.44) are not unique, but the global mean speed γ , if any, does not depend on the choice of the families $(\Omega_t^\pm)_{t \in \mathbb{R}}$ and $(\Gamma_t)_{t \in \mathbb{R}}$, see [19].

Before giving our main results, we first give the definitions of blocking and complete propagation below. The solution u emanating from the planar front $\phi(x_1 - ct)$ in the left half-cylinder with smaller section and going to the right one with larger section can be blocked, in the sense that

$$u(t, x) \rightarrow u_\infty(x) \text{ as } t \rightarrow +\infty \text{ locally uniformly in } x \in \bar{\Omega}, \text{ with } u_\infty(x) \rightarrow 0 \text{ as } x_1 \rightarrow +\infty. \quad (1.45)$$

The solution of (1.33) emanating from the planar front $\phi(x_1 - ct)$ propagates completely in the sense that

$$u(t, x) \rightarrow 1 \text{ as } t \rightarrow +\infty \text{ locally uniformly in } x \in \bar{\Omega}. \quad (1.46)$$

General properties for any given (R, α)

Our first result is the well-posedness of problem (1.33) with the asymptotic past condition (1.39) as $t \rightarrow -\infty$, for any given $R > 0$ and $\alpha \in [0, \pi/2)$.

Proposition 1.15. *For any $R > 0$ and $\alpha \in [0, \pi/2)$, problem (1.33) admits a unique entire solution $u(t, x)$ emanating from the planar front $\phi(x_1 - ct)$, in the sense of (1.39). Moreover, $u_t(t, x) > 0$ and $0 < u(t, x) < 1$ for all $(t, x) \in \mathbb{R} \times \bar{\Omega}$, and there exists $u_\infty(x) = \lim_{t \rightarrow +\infty} u(t, x)$ in $C_{loc}^2(\bar{\Omega})$ satisfying $0 < u_\infty(x) \leq 1$ in $\bar{\Omega}$ and*

$$\begin{cases} \Delta u_\infty + f(u_\infty) = 0 & \text{in } \bar{\Omega}, \\ \nu \cdot \nabla u_\infty = 0 & \text{on } \partial\Omega. \end{cases} \quad (1.47)$$

Lastly, for each $t \in \mathbb{R}$, the function $u(t, \cdot)$ is axisymmetric with respect to the x_1 -axis, that is, it only depends on x_1 and $|x'|$, with $x' = (x_2, \dots, x_N)$.

Once the well-posedness of (1.33) with the past condition (1.39) is established, we then focus on the large time dynamics of the solution u given in Proposition 1.15. It turns out that the complete propagation in the sense of (1.46) or the blocking in the sense of (1.45) are the only two possible outcomes. Namely, we will show that the following dichotomy holds.

Theorem 1.16. *For any $R > 0$ and $\alpha \in [0, \pi/2)$, let u be the solution of (1.33) and (1.39) given in Proposition 1.15. Then, either u propagates completely in the sense of (1.46), or it is blocked in the sense of (1.45) and then the convergence of $u(t, \cdot)$ to u_∞ as $t \rightarrow +\infty$ in (1.45) is uniform in $\bar{\Omega}$.*

Remark 1.17. *When $\alpha = 0$ in (1.37)–(1.38), Ω amounts to a straight cylinder and, by uniqueness, the solution u given in Proposition 1.15 is nothing but the planar front $\phi(x_1 - ct)$, hence the propagation is complete in this very particular case.*

Theorem 1.16 means that, under the notations of Proposition 1.15, either $u_\infty \equiv 1$ in $\bar{\Omega}$, or $u_\infty(x) \rightarrow 0$ as $x_1 \rightarrow +\infty$. Any other more complex behavior is impossible. Theorem 1.16 is a consequence of the stability of the solution u_∞ and of some Liouville type results for the stable solutions of some semilinear elliptic equations in the two-dimensional plane, or in a two-dimensional half-plane, or in the whole space \mathbb{R}^N with axisymmetry. In order to give a flavor of these properties and results, which are also of independent interest, let us state here

1. General introduction

the definition of stability¹ as well as one of the typical results shown in Section 5.3.2. So, for a non-empty open connected set $\omega \subset \mathbb{R}^N$, we say that a $C^2(\bar{\omega})$ solution U of $\Delta U + f(U) = 0$ in $\bar{\omega}$ is stable if

$$\int_{\bar{\omega}} |\nabla \psi|^2 - f'(U)\psi^2 \geq 0 \quad (1.48)$$

for every $\psi \in C^1(\bar{\omega})$ with compact support (for instance, it turns out that the solution u_∞ of (1.47) in $\bar{\Omega}$, given in Proposition 1.15, is stable, see Lemma 5.19). The following result, concerned with stable axisymmetric solutions, is also shown in Section 5.3.2.

Proposition 1.18. *Let $0 \leq U \leq 1$ be a $C^2(\mathbb{R}^N)$ stable solution of $\Delta U + f(U) = 0$ in \mathbb{R}^N . Assume that U is axisymmetric with respect to the x_1 -axis, that is, U depends on x_1 and $|x'|$ only, with $x' = (x_2, \dots, x_N)$. Then, either $U \equiv 0$ in \mathbb{R}^N or $U \equiv 1$ in \mathbb{R}^N .*

Coming back to problem (1.33) in funnel-shaped domains, we then turn to the study of the spreading properties and the behavior of the level sets of the solutions under the complete propagation condition (1.46) when $\alpha \in (0, \pi/2)$. In the sequel, we denote the level sets and the upper level sets of u by:

$$\mathcal{E}_\lambda(t) = \{x \in \bar{\Omega} : u(t, x) = \lambda\}, \quad \mathcal{U}_\lambda(t) = \{x \in \bar{\Omega} : u(t, x) > \lambda\}, \quad \text{for } \lambda \in (0, 1) \text{ and } t \in \mathbb{R}. \quad (1.49)$$

Theorem 1.19. *For any $R > 0$ and $\alpha \in (0, \pi/2)$, let u be the solution of (1.33) and (1.39) given in Proposition 1.15. If u propagates completely in the sense of (1.46), then it is a transition front connecting 1 and 0 with global mean speed c , and $(\Gamma_t)_{t \in \mathbb{R}}, (\Omega_t^\pm)_{t \in \mathbb{R}}$ in Definition 1.14 can be defined by*

$$\begin{cases} \Gamma_t = \{x \in \Omega : x_1 = ct\} & \text{for } t \leq t_0, \\ \Gamma_t = \left\{x \in \Omega : x_1 > 0 \text{ and } |x| = ct - \frac{N-1}{c} \ln t\right\} & \text{for } t > t_0, \end{cases} \quad (1.50)$$

and

$$\begin{cases} \Omega_t^\pm = \{x \in \Omega : \pm(x_1 - ct) < 0\} & \text{for } t \leq t_0, \\ \Omega_t^+ = \left\{x \in \Omega : x_1 \leq 0, \text{ or } x_1 > 0 \text{ and } |x| < ct - \frac{N-1}{c} \ln t\right\} & \text{for } t > t_0, \\ \Omega_t^- = \left\{x \in \Omega : x_1 > 0 \text{ and } |x| > ct - \frac{N-1}{c} \ln t\right\} & \text{for } t > t_0, \end{cases} \quad (1.51)$$

with $t_0 > 0$ large enough such that $ct - ((N-1)/c) \ln t > L$ for all $t > t_0$.² Moreover, u converges to planar fronts locally along its level sets as $t \rightarrow +\infty$: for any $\lambda \in (0, 1)$, any

¹For a thorough study of stable solutions of elliptic equations, we refer to the book [67].

²We recall that L is given in (1.38), with $L > R$.

1.3. Reaction-diffusion fronts in funnel-shaped domains

sequence $(t_n)_{n \in \mathbb{N}}$ diverging to $+\infty$ and any sequence $(x_n)_{n \in \mathbb{N}}$ in $\bar{\Omega}$ such that $u(t_n, x_n) = \lambda$, then

$$u(t + t_n, x + x_n) - \phi\left(x \cdot \frac{x_n}{|x_n|} - ct + \phi^{-1}(\lambda)\right) \longrightarrow 0 \text{ in } C_{(t,x);loc}^{1,2}(\mathbb{R} \times \mathbb{R}^N) \text{ as } n \rightarrow +\infty \quad (1.52)$$

if $d(x_n, \partial\Omega) \rightarrow +\infty$ as $n \rightarrow +\infty$, and the same limit holds with the additional restriction $x + x_n \in \bar{\Omega}$ if $\limsup_{n \rightarrow +\infty} d(x_n, \partial\Omega) < +\infty$. Lastly, for every $\lambda \in (0, 1)$, there exists $r_0 > 0$ such that the upper level set $\mathcal{U}_\lambda(t)$ satisfies

$$S_{r(t)-r_0} \subset \mathcal{U}_\lambda(t) \subset S_{r(t)+r_0} \quad (1.53)$$

for all t large enough (see Figure 4), with S_r and $r(t)$ given by

$$S_r = \bar{\Omega}^- \cup \{x \in \bar{\Omega} : |x| \leq r\}, \quad r(t) = ct - \frac{N-1}{c} \ln t.$$

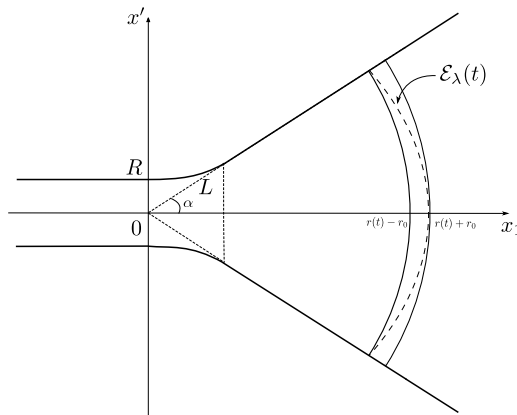

Figure 4: Possible location of the level set $\mathcal{E}_\lambda(t)$ for $\lambda \in (0, 1)$ and $t > 0$ large.

In other words, the past condition (1.39) and the complete propagation condition (1.46) guarantee the spreading of the solution u and the propagation with global mean speed c . Furthermore, the width of the transition between the limit states 1 and 0 is uniformly bounded in time in the sense of Definition 1.14 and the solution locally converges to planar fronts as $t \rightarrow +\infty$. The estimates of the location of the level sets as $t \rightarrow +\infty$ are established by constructing sub- and supersolutions whose level sets have roughly expanding spherical shapes of radii $ct - ((N-1)/c) \ln t + O(1)$, see Lemma 5.20. The logarithmic gap $((N-1)/c) \ln t$ is due to the curvature of the level sets, and these estimates are similar to those obtained in [154] for the solutions of the Cauchy problem in \mathbb{R}^N with compactly supported initial conditions and complete propagation. In our case, at time $t = 0$ (as at any other time), the function $x \mapsto u(t, x)$ converges to 0 as $x_1 \rightarrow +\infty$, but it then invades the right part of the

1. General introduction

domain, a situation similar to the case of invading solutions with initial compact support in \mathbb{R}^N .

It also turns out, this time immediately from Proposition 1.15, that the solutions u that are blocked are still transition fronts connecting 1 and 0, but they do not have any global mean speed.

Theorem 1.20. *For any $R > 0$ and $\alpha \in (0, \pi/2)$, let u be the solution of (1.33) and (1.39) given in Proposition 1.15. If u is blocked in the sense of (1.45), then it is a transition front connecting 1 and 0 without any global mean speed, and $(\Gamma_t)_{t \in \mathbb{R}}$, $(\Omega_t^\pm)_{t \in \mathbb{R}}$ can be defined by*

$$\begin{cases} \Gamma_t = \{x \in \Omega : x_1 = ct\} & \text{and } \Omega_t^\pm = \{x \in \Omega : \pm(x_1 - ct) < 0\} & \text{for } t \leq 0, \\ \Gamma_t = \{x \in \Omega : x_1 = 0\} & \text{and } \Omega_t^\pm = \{x \in \Omega : \pm x_1 < 0\} & \text{for } t > 0. \end{cases} \quad (1.54)$$

Complete propagation for large R

From now on, we investigate the effect of the parameters R and α of the funnel-shaped domains $\Omega = \Omega_{R,\alpha}$ on the propagation phenomena of the front-like solution u of (1.33) satisfying the past condition (1.39). We first recall that, when $\alpha = 0$, $u(t, x) \equiv \phi(x_1 - ct)$ and the propagation is complete, whatever $R > 0$ may be. Our next result provides some sufficient conditions on the size $R > 0$ to ensure the complete propagation condition (1.46) when $\alpha > 0$.

Theorem 1.21. *There is $R_0 > 0$ such that, if $R \geq R_0$ and $\alpha > 0$, then the unique solution u of (1.33) satisfying (1.39) propagates completely in the sense of (1.46), and therefore all the conclusions of Theorem 1.19 are valid.*

This theorem shows that the invasion always occurs no matter the size of the opening angle in the right part is, provided the left part of the domain is not too thin (see Figure 5).

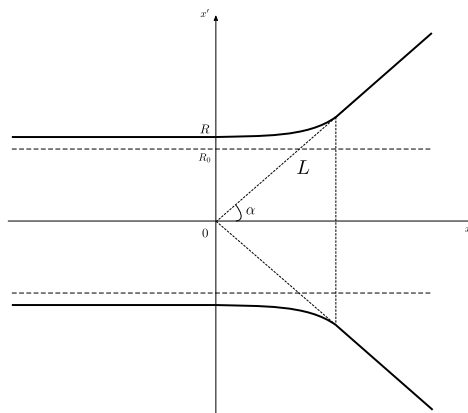

Figure 5: Schematic figure of the domain $\Omega_{R,\alpha}$ for $\alpha \in (0, \pi/2)$ and $R > R_0$.

Blocking for $R \ll 1$ and α not too small

The next result is concerned with blocking phenomena. We prove that the solution u of (1.33) in $\Omega_{R,\alpha}$ with past condition (1.39) is blocked if R is sufficiently small and α is sufficiently close to $\pi/2$ (see Figure 6).

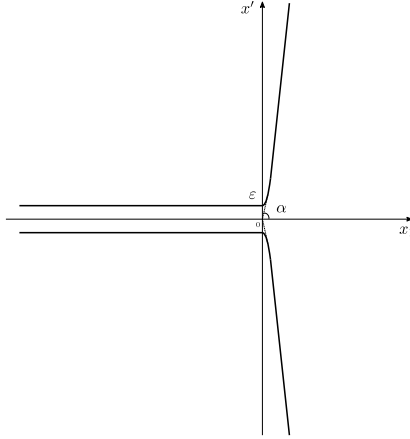

Figure 6: Schematic figure of the domain $\Omega_{\varepsilon,\alpha}$ for $R = \varepsilon \ll 1$.

Theorem 1.22. *Assume that $N \geq 3$ and let $L_* > 0$ and $\alpha_* \in (0, \pi/2)$ be given. Then there is $R_* > 0$ such that, if $0 < R \leq R_*$, $\alpha_* \leq \alpha < \pi/2$ and $L \leq L_*$ in (1.37)–(1.38), then the solution u of (1.33) in Ω with past condition (1.39) is blocked, in the sense of (1.45).*

From a biological point of view, Theorem 1.22 says that as the species goes from a very narrow passage into a suddenly wide open space, the diffusion disperses the population to lower density where the reaction behaves adversely. That prevents the species from rebuilding a strong enough basis to invade the right part of the domain. This phenomenon is similar to the problem studied in [49], although the proof given here, based on the construction of suitable supersolutions, is completely different.

Let us now make some further remarks on the effect of the geometry of the domain on invasion or blocking phenomena. In population dynamics, where u stands for the population density, one can think of the invasion of fishes from mountain streams into an endless ocean, and more generally speaking the invasion of plants or animals subject to an Allee effect and going from an isthmus into a large area. In medical sciences, the bistable reaction-diffusion equation is used to model the motion of depolarization waves in the brain, in which the domain can be thought of as a portion of grey matter of the brain with different thickness: here u represents the degree of depolarization, and the Neumann boundary condition means that the grey matter is assumed to be isolated. Equations of the type (1.33) can also be used to study ventricular fibrillations. Ventricular fibrillation is a state of electrical anarchy in part of the heart that leads to rapid chaotic contractions, which are fatal unless a normal rhythm can

1. General introduction

be restored by defibrillation. When excitation waves enter the circular area of cardiac tissue, they are trapped and their propagation triggers off ventricular fibrillations [10]. Therefore, understanding how the geometrical properties of the cardiac fibres or fibre bundles affect or even block the propagation of excitation waves is of vital importance. For more detailed backgrounds and explanations from biological view point, we refer to [49, 11, 86] and the references therein.

The set of parameters (R, α) with complete propagation is open in $(0, +\infty) \times (0, \pi/2)$

In the final main result, we show that if the front-like solution u emanating from the planar traveling front satisfies the complete propagation property (1.46) in $\Omega_{R,\alpha}$ for some $R > 0$ and $\alpha \in (0, \pi/2)$, then, with a slight perturbation of R and α , the solution u will still propagate completely in the perturbed domain. For this result, we use an additional assumption on the continuous dependence of $\Omega_{R,\alpha}$ with respect to (R, α) .

Theorem 1.23. *Assume that the functions h given in (1.37)–(1.38) depend continuously on the parameters $(R, \alpha) \in (0, +\infty) \times (0, \pi/2)$ in the $C_{loc}^{2,\beta}(\mathbb{R})$ sense, with $0 < \beta < 1$. Then the set of parameters (R, α) such that the solution u of (1.33) in $\Omega_{R,\alpha}$ with past condition (1.39) propagates completely, in the sense of (1.46), is open in $(0, +\infty) \times (0, \pi/2)$.*

The continuity of the functions h given in (1.37)–(1.38) implies the local continuity of the domains $\Omega_{R,\alpha}$ in the sense of the Hausdorff distance. This continuity holds only in a local sense, since actually the Hausdorff distance between $\Omega_{R,\alpha}$ and $\Omega_{R',\alpha'}$ is infinite as soon as $\alpha \neq \alpha'$. But the local continuity is sufficient to guarantee the validity of (1.46) under small perturbations of (R, α) . The proof of Theorem 1.23 is done by way of contradiction and it uses, as that of Theorem 1.21, the existence of a compactly supported subsolution, with maximum larger than θ , to the elliptic problem (1.47).

From Theorems 1.16 and 1.23, the next corollary follows immediately.

Corollary 1.24. *Under the assumptions of Theorem 1.23, the set of parameters $(R, \alpha) \in (0, +\infty) \times (0, \pi/2)$ such that the solution u of (1.33) in $\Omega_{R,\alpha}$ with past condition (1.39) is blocked, in the sense of (1.45), is relatively closed in $(0, +\infty) \times (0, \pi/2)$.*

1.4 Propagation phenomena in patchy landscapes with interface conditions

Propagation phenomena in periodic patchy landscapes

We consider a patchy periodically alternating landscape consisting of two types of patches (say, type 1 and 2); see Figure 7. Each patch is homogeneous within. We denote the length

1.4. Propagation phenomena in patchy landscapes with interface conditions

of patch type i ($i = 1, 2$) by l_i so that the period is $l = l_1 + l_2$. Accordingly, the real line is divided into intervals of the form

$$I_n = [nl - l_1, nl + l_2], \quad n \in \mathbb{Z},$$

each consisting of two adjacent patches. Such intervals were called “tiles” in [54].

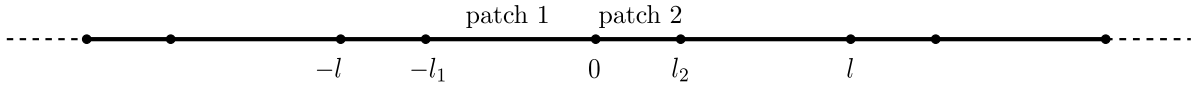

Figure 7: Schematic figure of the one-dimensional periodic patchy environment.

For $n \in \mathbb{Z}$, let $I_{1n} = (nl - l_1, nl)$ be the patches of type 1 and $I_{2n} = (nl, nl + l_2)$ be the patches of type 2. On each patch I_{in} , we denote by $v_{in} = v|_{I_{in}}$ the density of the population, by d_i the constant diffusion coefficients, and by f_i the corresponding reaction nonlinearities. Our model then reads, for $n \in \mathbb{Z}$,

$$\begin{cases} \frac{\partial v_{1n}}{\partial t} = d_1 \frac{\partial^2 v_{1n}}{\partial x^2} + f_1(v_{1n}), & t > 0, \quad x \in (nl - l_1, nl), \\ \frac{\partial v_{2n}}{\partial t} = d_2 \frac{\partial^2 v_{2n}}{\partial x^2} + f_2(v_{2n}), & t > 0, \quad x \in (nl, nl + l_2). \end{cases} \quad (1.55)$$

In (1.55), the equations for $v_{in} = v|_{I_{in}}$ are set in the open intervals $(nl - l_1, nl)$ and $(nl, nl + l_2)$, but it will eventually turn out that the constructed solutions are such that the functions v_{in} can be extended in $(0, +\infty) \times [nl - l_1, nl]$ or $(0, +\infty) \times [nl, nl + l_2]$ as $C_{t;x}^{1;2}$ functions, so that equations (1.55) will be satisfied in the closed intervals $[nl - l_1, nl]$ and $[nl, nl + l_2]$. The matching conditions for the population density and flux at the interfaces are given by

$$\begin{cases} v_{1n}(t, x^-) = kv_{2n}(t, x^+), & d_1(v_{1n})_x(t, x^-) = d_2(v_{2n})_x(t, x^+), & t > 0, \quad x = nl, \\ kv_{2n}(t, x^-) = v_{1(n+1)}(t, x^+), & d_2(v_{2n})_x(t, x^-) = d_1(v_{1(n+1)})_x(t, x^+), & t > 0, \quad x = nl + l_2, \end{cases} \quad (1.56)$$

with parameter

$$k = \frac{\alpha}{1 - \alpha} \times \frac{d_2}{d_1}. \quad (1.57)$$

Here, $\alpha \in (0, 1)$ denotes the probability that an individual at the interface chooses to move to the adjacent patch of type 1, and $1 - \alpha$ the probability that it moves to the patch of type 2. Individuals cannot stay at the interfaces. These interface conditions were derived in [133] and studied in more detail in [121]. They reflect the movement behavior of individuals when they come to the edge of a patch. With these interface conditions, the population density is discontinuous across a patch interface in the presence of patch preference and/or when the

1. General introduction

diffusion rates in these two kinds of patches are different. Throughout this work, we assume that the reaction terms f_i ($i = 1, 2$) have the properties:

$$f_i \in C^1(\mathbb{R}), f_i(0) = 0, \text{ and there is } K_i > 0 \text{ such that } f_i \leq 0 \text{ in } [K_i, +\infty). \quad (1.58)$$

Without loss of generality, we will consider type-1 patches as more favorable than type-2 patches, that is, $f_1'(0) \geq f_2'(0)$. In some statements, we will also assume that type-1 patches are ‘‘source’’ patches, i.e., patches where the intrinsic growth rate of the population is positive ($f_1'(0) > 0$), while type-2 patches may be source patches ($f_2'(0) > 0$), or ‘‘sink’’ patches ($f_2'(0) < 0$), or such that $f_2'(0) = 0$. In order to investigate the long-time behavior and spatial dynamics, we will further assume in some statements that the functions f_i satisfy the strong Fisher-KPP assumption:

$$\left\{ \begin{array}{l} \text{the functions } s \mapsto \frac{f_i(s)}{s} \text{ are non-increasing in } s > 0 \text{ for } i = 1, 2, \\ \text{and decreasing in } s > 0 \text{ for at least one } i. \end{array} \right. \quad (1.59)$$

For instance, f_i satisfying hypotheses (1.58)–(1.59) can be functions of the type $f_i(s) = s(\mu_i - s)$.

Since the discontinuity in the densities at the interfaces makes the problem quite delicate to study, we rescale the densities in such a way that the matching conditions become continuous in the density. More precisely, we set $u_{1n}(t, x) = v_{1n}(t, x)$ for $t \geq 0$, $x \in (nl - l_1, nl)$ and $n \in \mathbb{Z}$, and $u_{2n}(t, x) = kv_{2n}(t, x)$ for $t \geq 0$, $x \in (nl, nl + l_2)$ and $n \in \mathbb{Z}$. Then u_{1n} satisfy the same equations as v_{1n} with $\tilde{f}_1(s) = f_1(s)$, while u_{2n} satisfy the equations of v_{2n} with f_2 replaced by $\tilde{f}_2(s) = kf_2(s/k)$. We notice that \tilde{f}_i ($i = 1, 2$) satisfy the same hypotheses as f_i with K_i replaced by \tilde{K}_i where $\tilde{K}_1 = K_1$ and $\tilde{K}_2 = kK_2$. Thanks to the change of variables, the interface conditions for the densities are now continuous; however, the flux interface conditions become discontinuous, namely,

$$\left\{ \begin{array}{l} u_{1n}(t, x^-) = u_{2n}(t, x^+), \quad d_1(u_{1n})_x(t, x^-) = \frac{d_2}{k}(u_{2n})_x(t, x^+), \quad t > 0, x = nl, \\ u_{2n}(t, x^-) = u_{1(n+1)}(t, x^+), \quad \frac{d_2}{k}(u_{2n})_x(t, x^-) = d_1(u_{1(n+1)})_x(t, x^+), \quad t > 0, x = nl + l_2. \end{array} \right.$$

We drop the tilde from hereon. Notice that the properties (1.58) and (1.59) are invariant under this change. Putting it all together, we are led to the following problem:

$$\left\{ \begin{array}{l} \frac{\partial u_{1n}}{\partial t} = d_1 \frac{\partial^2 u_{1n}}{\partial x^2} + f_1(u_{1n}), \quad t > 0, x \in (nl - l_1, nl), \\ \frac{\partial u_{2n}}{\partial t} = d_2 \frac{\partial^2 u_{2n}}{\partial x^2} + f_2(u_{2n}), \quad t > 0, x \in (nl, nl + l_2), \end{array} \right. \quad (1.60)$$

1.4. Propagation phenomena in patchy landscapes with interface conditions

with continuous density conditions and discontinuous flux interface conditions,

$$\begin{cases} u_{1n}(t, x^-) = u_{2n}(t, x^+), & (u_{1n})_x(t, x^-) = \sigma(u_{2n})_x(t, x^+), & t > 0, x = nl, \\ u_{2n}(t, x^-) = u_{1(n+1)}(t, x^+), & \sigma(u_{2n})_x(t, x^-) = (u_{1(n+1)})_x(t, x^+), & t > 0, x = nl + l_2, \end{cases} \quad (1.61)$$

in which, from (1.57), we have

$$\sigma = \frac{d_2}{kd_1} = \frac{1 - \alpha}{\alpha} > 0. \quad (1.62)$$

When $\sigma = 1$ (that is, $\alpha = 1/2$), the model (1.60)–(1.61) is reduced to the one in [146].

From now on, we denote by

$$S_1 = l\mathbb{Z}$$

the interface points between $(nl - l_1, nl)$ and $(nl, nl + l_2)$, and by

$$S_2 = \{s + l_2 : s \in l\mathbb{Z}\}$$

the interface points between $(nl, nl + l_2)$ and $(nl + l_2, (n + 1)l)$. Therefore, $S = S_1 \cup S_2$ represents all the interface points in \mathbb{R} . For convenience of our analysis, by setting $u(t, x) = u_{1n}(t, x)$ for $t > 0$ and $x \in (nl - l_1, nl)$, $u(t, x) = u_{2n}(t, x)$ for $t > 0$ and $x \in (nl, nl + l_2)$, $u(t, x) = u_{1n}(t, x^-) = u_{2n}(t, x^+)$ for $t > 0$ and $x = nl$, and $u(t, x) = u_{2n}(t, x^-) = u_{1(n+1)}(t, x^+)$ for $t > 0$ and $x = nl + l_2$, we rewrite the above model (1.60)–(1.61) in the following form:

$$\begin{cases} u_t - d(x)u_{xx} = f(x, u), & t > 0, x \in \mathbb{R} \setminus S, \\ u(t, x^-) = u(t, x^+), \quad u_x(t, x^-) = \sigma u_x(t, x^+), & t > 0, x \in S_1, \\ u(t, x^-) = u(t, x^+), \quad \sigma u_x(t, x^-) = u_x(t, x^+), & t > 0, x \in S_2, \end{cases} \quad (1.63)$$

where the diffusivity d and nonlinearity f are given by

$$d(x) = \begin{cases} d_1, & x \in (nl - l_1, nl), \\ d_2, & x \in (nl, nl + l_2), \end{cases} \quad f(x, s) = \begin{cases} f_1(s), & x \in (nl - l_1, nl), \\ f_2(s), & x \in (nl, nl + l_2), \end{cases} \quad (1.64)$$

and the parameter $\sigma > 0$ is defined as in (1.62). Conditions (1.58) and (1.59) on f_i are equivalent to the following ones:

$$\begin{cases} \forall x \in \mathbb{R} \setminus S, f(x, \cdot) \in C^1(\mathbb{R}), f(x, 0) = 0, \\ \exists M = \max(K_1, K_2) > 0, \forall x \in \mathbb{R} \setminus S, \forall s \geq M, f(x, s) \leq 0, \\ \forall x \in (nl - l_1, nl), f(x, \cdot) = f_1, \quad \forall x \in (nl, nl + l_2), f(x, \cdot) = f_2. \end{cases} \quad (1.65)$$

1. General introduction

and

$$\left\{ \begin{array}{l} \text{the functions } s \mapsto \frac{f(x, s)}{s} \text{ are non-increasing in } s > 0 \text{ in all patches,} \\ \text{and decreasing in } s > 0 \text{ in at least one type of patch.} \end{array} \right. \quad (1.66)$$

From now on, we always assume that (1.65) is satisfied. Throughout this work, unless otherwise specified, we always write I for an arbitrary patch in \mathbb{R} of either type, i.e., either $I = (nl - l_1, nl)$ or $I = (nl, nl + l_2)$.

Well-posedness of the Cauchy problem (1.63)–(1.64)

Since the patch model considered here is not standard, we shall first establish the well-posedness of the Cauchy problem (1.63)–(1.64) with hypotheses (1.65) on f and with non-negative bounded and continuous initial conditions $u_0 : \mathbb{R} \rightarrow \mathbb{R}$. Before proceeding with the analysis, we present here the definition of a classical solution to (1.63)–(1.64).

Definition 1.25. *For $T \in (0, +\infty]$, we say that a continuous function $u : [0, T) \times \mathbb{R} \rightarrow \mathbb{R}$ is a classical solution of the Cauchy problem (1.63)–(1.64) in $[0, T) \times \mathbb{R}$ with an initial condition u_0 , if $u(0, \cdot) = u_0$, if $u|_{(0, T) \times \bar{I}} \in C_{t;x}^{1;2}((0, T) \times \bar{I})$ for each patch $I = (nl - l_1, nl)$ or $(nl, nl + l_2)$, and if all identities in (1.63) are satisfied pointwise for $0 < t < T$.*

Theorem 1.26. *Under assumption (1.65), for any nonnegative bounded continuous initial condition u_0 , there is a nonnegative bounded classical solution u in $[0, +\infty) \times \mathbb{R}$ of the Cauchy problem (1.63)–(1.64) such that, for any $\tau > 0$ and any patch $I \subset \mathbb{R}$,*

$$\|u|_{[\tau, +\infty) \times \bar{I}}\|_{C_{t;x}^{1,\gamma;2,\gamma}([\tau, +\infty) \times \bar{I})} \leq C,$$

with a positive constant C depending on τ , $l_{1,2}$, $d_{1,2}$, $f_{1,2}$, σ and $\|u_0\|_{L^\infty(\mathbb{R})}$, and with a universal positive constant $\gamma \in (0, 1)$. Moreover, $u(t, x) > 0$ for all $(t, x) \in (0, +\infty) \times \mathbb{R}$ if $u_0 \not\equiv 0$, and $u(t, x) = u(t, x + l)$ for all $(t, x) \in [0, +\infty) \times \mathbb{R}$ if $u_0(x) = u_0(x + l)$ for all $x \in \mathbb{R}$. Lastly, the solutions depend monotonically and continuously on the initial data, in the sense that if $u_0 \leq v_0$ then the corresponding solutions satisfy $u \leq v$ in $[0, +\infty) \times \mathbb{R}$, and for any $T \in (0, +\infty)$ the map $u_0 \mapsto u$ is continuous from $C^+(\mathbb{R}) \cap L^\infty(\mathbb{R})$ to $C([0, T] \times \mathbb{R}) \cap L^\infty([0, T] \times \mathbb{R})$ equipped with the sup norms, where $C^+(\mathbb{R})$ denotes the set of nonnegative continuous functions in \mathbb{R} .

We remark that the existence and uniqueness of a global bounded periodic classical solution to such a patch model was considered in [120] for (1.55)–(1.56) with periodic and possibly discontinuous initial data. By contrast, our result is established for general continuous and bounded initial data. Moreover, we also discuss the continuous dependence of solutions on initial data and give a priori estimates, which will play a critical role in the monotone semiflow

argument used in the sequel. The well-posedness proof here can also be adapted to other non-periodic patch problems.

Existence, uniqueness and attractiveness of a positive periodic steady state

To investigate the existence and uniqueness of a positive bounded steady state as well as the large-time behavior of solutions to the Cauchy problem, we first study the following eigenvalue problem. From [121, 146] (see also Lemma 6.20 below), there exists a principal eigenvalue λ_1 , defined as the unique real number such that there exists a unique continuous function $\phi : \mathbb{R} \rightarrow \mathbb{R}$ with $\phi|_{\bar{I}} \in C^\infty(\bar{I})$ for each patch I , that satisfies

$$\begin{cases} \mathcal{L}_0\phi := -d(x)\phi'' - f_s(x, 0)\phi = \lambda_1\phi, & x \in \mathbb{R} \setminus S, \\ \phi(x^-) = \phi(x^+), \phi'(x^-) = \sigma\phi'(x^+), & x \in S_1, \\ \phi(x^-) = \phi(x^+), \sigma\phi'(x^-) = \phi'(x^+), & x \in S_2, \\ \phi(x) \text{ is periodic, } \phi > 0, \|\phi\|_{L^\infty(\mathbb{R})} = 1. \end{cases} \quad (1.67)$$

By periodic, we mean that $\phi(\cdot + l) = \phi$ in \mathbb{R} . In the sequel we say that 0 is an unstable steady state of (1.63) if $\lambda_1 < 0$, otherwise the state 0 is said to be stable (i.e., $\lambda_1 \geq 0$). These definitions will be seen to be natural in view of the results we prove here. By applying (1.67) at minimal and maximal points of the positive continuous periodic function ϕ , whether these points be in patches or on the interfaces, it easily follows that

$$-f'_1(0) \leq \lambda_1 \leq -f'_2(0)$$

(remember that $f'_1(0) \geq f'_2(0)$ without loss of generality). In particular, if $\lambda_1 < 0$, then $f'_1(0) > 0$, that is, $f_s(x, 0)$ is necessarily positive (at least) in the favorable patches.

We first state a criterion for the existence of a continuous solution $p : \mathbb{R} \rightarrow \mathbb{R}$ (such that $p|_{\bar{I}} \in C^2(\bar{I})$ for each patch I) to the elliptic problem:

$$\begin{cases} -d(x)p''(x) - f(x, p(x)) = 0, & x \in \mathbb{R} \setminus S, \\ p(x^-) = p(x^+), p'(x^-) = \sigma p'(x^+), & x \in S_1, \\ p(x^-) = p(x^+), \sigma p'(x^-) = p'(x^+), & x \in S_2. \end{cases} \quad (1.68)$$

Theorem 1.27. (i) Assume that 0 is an unstable solution of (1.68) (i.e., $\lambda_1 < 0$) and that f satisfies (1.65). Then there exists a bounded positive and periodic solution p of (1.68).

(ii) Assume that 0 is a stable solution of (1.68) (i.e., $\lambda_1 \geq 0$) and that f satisfies (1.65)–(1.66). Then 0 is the only nonnegative bounded solution of (1.68).

Let us now provide an insight into the stability of the trivial solution of (1.68). Under certain reasonable hypotheses on the diffusivities, the sizes of favorable and unfavorable

1. General introduction

patches, as well as the nonlinearities, the principal eigenvalue λ_1 of (1.67) can indeed be negative. For example, when all patches support population growth, namely $f_1'(0) > 0$ and $f_2'(0) > 0$, then the zero state is unstable. When the landscape consists of source and sink patches, i.e., when $f_1'(0) > 0 > f_2'(0)$, the stability of the zero state depends on the relationships between patch size, patch preference, diffusivity and growth rates. In the case $\sigma = 1$, Shigesada and coworkers derived such a stability criterion [146]; the case for general $\sigma > 0$ can be found in [121]. We here derive an even more general formula, when we only assume that $f_2'(0) \leq f_1'(0)$. To do so, we first observe that the continuous functions $x \mapsto \phi(-l_1 - x)$ and $x \mapsto \phi(l_2 - x)$ still solve (1.67) as ϕ does, and by uniqueness we get that $\phi(-l_1 - x) = \phi(l_2 - x) = \phi(x)$ for all $x \in \mathbb{R}$, hence $\phi'(-l_1/2) = \phi'(l_2/2) = 0$. Then, as in [121, 146], by solving (1.67) in $[-l_1/2, 0]$ and in $[0, l_2/2]$ with zero derivatives at $-l_1/2$ and $l_2/2$, and by matching the interface conditions at 0, we find that λ_1 is the smallest root in $[-f_1'(0), -f_2'(0)]$ of the equation:

$$\sqrt{\frac{f_1'(0) + \lambda_1}{d_1}} \tan\left(\sqrt{\frac{f_1'(0) + \lambda_1}{d_1}} \times \frac{l_1}{2}\right) = \sigma \sqrt{-\frac{\lambda_1 + f_2'(0)}{d_2}} \tanh\left(\sqrt{-\frac{\lambda_1 + f_2'(0)}{d_2}} \times \frac{l_2}{2}\right). \quad (1.69)$$

When $0 < f_2'(0) \leq f_1'(0)$ or when $0 = f_2'(0) < f_1'(0)$ (irrespective of the other parameters), then the trivial solution of (1.68) is unstable (i.e., $\lambda_1 < 0$). When $f_2'(0) \leq f_1'(0) \leq 0$, then $\lambda_1 \geq 0$. When $f_2'(0) < 0 < f_1'(0)$, we then derive that the trivial solution of (1.68) is stable ($\lambda_1 \geq 0$) if

$$l_1 \leq l_1^c := 2\sqrt{\frac{d_1}{f_1'(0)}} \tan^{-1}\left(\sigma \sqrt{\frac{-d_1 f_2'(0)}{d_2 f_1'(0)}} \tanh\left(\sqrt{\frac{-f_2'(0)}{d_2}} \times \frac{l_2}{2}\right)\right) \quad (1.70)$$

(notice that $l_1^c > 0$), and unstable ($\lambda_1 < 0$) if $l_1 > l_1^c$. The persistence threshold l_1^c is decreasing with $f_1'(0) > 0$ and increasing with d_1 and l_2 . Passing to the limit $l_2 \rightarrow +\infty$, we find that

$$l_1^c \rightarrow L_1^c := 2\sqrt{\frac{d_1}{f_1'(0)}} \tan^{-1}\left(\sigma \sqrt{\frac{-d_1 f_2'(0)}{d_2 f_1'(0)}}\right).$$

Therefore, as long as $l_1 > L_1^c$, the trivial solution of (1.68) is unstable (i.e., $\lambda_1 < 0$), no matter how large the size of the unfavorable patches is. Similarly, there is a critical rate

$$(f_2'(0))^c = -\frac{d_2 f_1'(0)}{\sigma^2 d_1} \left[\tan\left(\sqrt{\frac{f_1'(0)}{d_1}} \times \frac{l_1}{2}\right) \right]^2$$

such that, if $0 > f_2'(0) > (f_2'(0))^c$, then the trivial solution of (1.68) is unstable (i.e., $\lambda_1 < 0$), no matter how large the size of the unfavorable patch is.

It also follows from (1.69) that, provided $f'_2(0) \neq f'_1(0)$, the principal eigenvalue λ_1 is increasing with respect to $\sigma > 0$, that is, λ_1 is decreasing with respect to $\alpha \in (0, 1)$. When $\alpha \in (0, 1)$ increases, then the individuals at the interfaces have more propensity to go to patches of type 1 rather than to patches of type 2. This means that the relative advantage of the more favorable patches becomes more prominent: λ_1 decreases and the 0 solution has more chances to become unstable. It is also easy to see that $\lambda_1 \rightarrow -f'_1(0)$ as $\sigma \rightarrow 0^+$ (that is, as $\alpha \rightarrow 1^-$), hence 0 is unstable if $\alpha \approx 1$, provided the patches of type 1 support population growth. On the other hand, $\lambda_1 \rightarrow \min(d_1\pi^2/l_1^2 - f'_1(0), -f'_2(0))$ as $\sigma \rightarrow +\infty$ (that is, as $\alpha \rightarrow 0^+$). Therefore, if $f'_1(0) \geq d_1\pi^2/l_1^2$, and even if $f'_2(0) < 0$, then 0 is still unstable when α is small (and actually whatever the value of $\alpha \in (0, 1)$ and the other parameters may be).

Next, we state a Liouville type result for problem (1.68).

Theorem 1.28. *Assume that f satisfies (1.65)–(1.66) and that the zero solution of (1.68) is unstable (i.e., $\lambda_1 < 0$). Then there exists at most one positive and bounded solution p of (1.68). Furthermore, such a solution p , if any, is periodic and $\inf_{\mathbb{R}} p = \min_{\mathbb{R}} p > 0$.*

Under the assumptions of Theorem 1.27 (i) and Theorem 1.28, we now look at the global attractiveness of the unique positive and bounded stationary solution p of (1.68) for the solutions of the Cauchy problem (1.63)–(1.64).

Theorem 1.29. *Assume that f satisfies (1.65)–(1.66). Let u be the solution of the Cauchy problem (1.63)–(1.64) with a nonnegative bounded and continuous initial datum $u_0 \not\equiv 0$.*

- (i) *If 0 is an unstable solution of (1.68) (i.e., $\lambda_1 < 0$), then $u(t, \cdot)|_{\bar{I}} \rightarrow p|_{\bar{I}}$ in $C^2(\bar{I})$ as $t \rightarrow +\infty$ for each patch I , where p is the unique positive bounded and periodic solution of (1.68) given by Theorem 1.27 (i) and Theorem 1.28.³*
- (ii) *If 0 is a stable solution of (1.68) (i.e., $\lambda_1 \geq 0$), then $u(t, \cdot) \rightarrow 0$ uniformly in \mathbb{R} as $t \rightarrow +\infty$.*

Spreading speeds and pulsating traveling waves

In this subsection, we assume that the zero solution of (1.68) is unstable (i.e., $\lambda_1 < 0$) and that f satisfies (1.65)–(1.66). Let p be the unique positive bounded and periodic solution of (1.68) obtained from Theorem 1.27 (i) and Theorem 1.28. After showing in Theorem 1.29 (i) the attractiveness of p , we now want to describe the way the positive steady state p invades the whole domain.

Let \mathcal{C} be the space of all bounded and uniformly continuous functions from \mathbb{R} to \mathbb{R} equipped with the compact open topology, i.e., we say that $u_n \rightarrow u$ as $n \rightarrow +\infty$ in \mathcal{C} when

³This statement shows that the solution u converges as $t \rightarrow +\infty$ locally uniformly in space to the space-periodic function p . For a convergence result to time-periodic solutions for time-periodic quasilinear parabolic equations, we refer to [46].

1. General introduction

$u_n \rightarrow u$ locally uniformly in \mathbb{R} . For $u, v \in \mathcal{C}$, we write $u \geq v$ when $u(x) \geq v(x)$ for all $x \in \mathbb{R}$, $u > v$ when $u \geq v$ and $u \not\equiv v$, and $u \gg v$ when $u(x) > v(x)$ for all $x \in \mathbb{R}$. Notice that $p \in \mathcal{C}$ is periodic and satisfies $p \gg 0$. We define

$$\mathcal{C}_p = \{v \in \mathcal{C} : 0 \leq v \leq p\}. \quad (1.71)$$

Let \mathbb{P} be the set of all continuous and periodic functions from \mathbb{R} to \mathbb{R} equipped with the L^∞ -norm, and $\mathbb{P}^+ = \{u \in \mathbb{P} : u \geq 0\}$.

The first result of this section states the existence of a speed of invasion by the state p .

Theorem 1.30. *Assume that f satisfies (1.65)–(1.66) and that the zero solution of (1.68) is unstable (i.e., $\lambda_1 < 0$). Then there is an asymptotic spreading speed, $c^* > 0$, given explicitly by*

$$c^* = \inf_{\mu > 0} \frac{-\lambda(\mu)}{\mu},$$

where $\lambda(\mu)$ is the principal eigenvalue of the operator

$$\mathcal{L}_\mu \psi(x) := -d(x)\psi''(x) + 2\mu d(x)\psi'(x) - (d(x)\mu^2 + f_s(x, 0))\psi(x) \text{ for } x \in \mathbb{R} \setminus S,$$

acting on the set

$$\begin{aligned} E_\mu = \{ \psi \in C(\mathbb{R}) : \psi|_{\bar{I}} \in C^2(\bar{I}) \text{ for each patch } I, \psi \text{ is periodic in } \mathbb{R}, \\ [-\mu\psi + \psi'](x^-) = \sigma[-\mu\psi + \psi'](x^+) \text{ for } x \in S_1, \\ \sigma[-\mu\psi + \psi'](x^-) = [-\mu\psi + \psi'](x^+) \text{ for } x \in S_2 \}, \end{aligned}$$

such that the following statements are valid:

- (i) if u is the solution to problem (1.63)–(1.64) with a compactly supported initial condition $u_0 \in \mathcal{C}_p$, then $\lim_{t \rightarrow +\infty} \sup_{|x| \geq ct} u(t, x) = 0$ for every $c > c^*$;
- (ii) if $u_0 \in \mathcal{C}_p$ with $u_0 \not\equiv 0$, then $\lim_{t \rightarrow +\infty} \max_{|x| \leq ct} |u(t, x) - p(x)| = 0$ for every $0 \leq c < c^*$.

It finally turns out that the asymptotic spreading speed c^* is also related to some speeds of rightward or leftward periodic (also called pulsating) traveling waves, whose definition is recalled:

Definition 1.31. *A bounded continuous solution $u : \mathbb{R} \times \mathbb{R} \rightarrow \mathbb{R}$ of problem (1.63)–(1.64) is called a periodic rightward traveling wave connecting $p(x)$ to 0 if it has the form $u(t, x) = W(x - ct, x)$, where $c \in \mathbb{R}$ and the function $W : \mathbb{R} \times \mathbb{R} \rightarrow \mathbb{R}$ has the properties: for each*

$s \in \mathbb{R}$ the map $x \mapsto W(x+s, x)$ is continuous⁴ and the map $x \mapsto W(s, x)$ is periodic, and for each $x \in \mathbb{R}$ the map $s \mapsto W(s, x)$ is decreasing with $W(-\infty, x) = p(x)$ and $W(+\infty, x) = 0$.

Similarly, a bounded continuous solution $u : \mathbb{R} \times \mathbb{R} \rightarrow \mathbb{R}$ of problem (1.63)–(1.64) is called a periodic leftward traveling wave connecting 0 to $p(x)$ if it has the form $u(t, x) = W(x+ct, x)$, where $c \in \mathbb{R}$ and the function $W : \mathbb{R} \times \mathbb{R} \rightarrow \mathbb{R}$ has the properties: for each $s \in \mathbb{R}$ the map $x \mapsto W(x+s, x)$ is continuous and the map $x \mapsto W(s, x)$ is periodic, and for each $x \in \mathbb{R}$ the map $s \mapsto W(s, x)$ is increasing with $W(-\infty, x) = 0$ and $W(+\infty, x) = p(x)$.

The following result shows that the asymptotic spreading speed c^* given in Theorem 1.30 coincides with minimal speeds of periodic traveling waves in the positive and negative directions.

Theorem 1.32. *Assume that the zero solution of (1.68) is unstable (i.e., $\lambda_1 < 0$) and that f satisfies (1.65)–(1.66). Let c^* be the asymptotic spreading speed given in Theorem 1.30. Then the following statements are valid:*

- (i) *problem (1.63)–(1.64) has a periodic rightward traveling wave $W(x-ct, x)$ connecting $p(x)$ to 0, in the sense of Definition 1.31, if and only if $c \geq c^*$;*
- (ii) *problem (1.63)–(1.64) has a periodic leftward traveling wave $W(x+ct, x)$ connecting 0 to $p(x)$, in the sense of Definition 1.31, if and only if $c \geq c^*$.*

Remark 1.33. It is known that for the standard spatially periodic Fisher-KPP problem $u_t = \nabla \cdot (D(x)\nabla u) + f(x, u)$, $(t, x) \in \mathbb{R}_+ \times \mathbb{R}$, the variational characterization of minimal speeds in terms of a family of principal eigenvalues implies that the minimal wave speeds of rightward and leftward pulsating waves are the same. Theorem 1.32 shows that this property still holds true for our one-dimensional patchy periodic habitat, with nonstandard movement behavior at interfaces.

Propagation and blocking in a two-patch reaction-diffusion model

In this subsection, we consider a one-dimensional infinite landscape comprised of two semi-infinite patches. We denote $(-\infty, 0)$ as patch 1 and $(0, \infty)$ as patch 2. The interface that separates the two patches occurs at $x = 0$. Our model consists of a reaction-diffusion equation for the species' density on each patch and conditions that match the density and flux across the interface. We assume that each patch is homogeneous but the two patches may differ, so that the diffusion coefficients and the reaction terms (i.e. net population growth rates) may differ. Whereas most existing models for propagation and propagation failure assume that the population dynamics outside of a bounded region are identical, we are explicitly interested in

⁴Notice that the continuity of $x \mapsto W(x+s, x)$ is automatic if $c \neq 0$, since u is assumed to be continuous itself in $\mathbb{R} \times \mathbb{R}$.

1. General introduction

the case where the dynamics differ, qualitatively and quantitatively, between the two patches. Hence, on each patch, the population density $u = u(x, t)$ satisfies an equation of the form

$$u_t = d_i u_{xx} + f_i(u), \quad (1.72)$$

where $i = 1, 2$, depending on patch type. Since we want the interface to be neutral with respect to reaction dynamics, (i.e. no individuals are born or die from crossing the interface), the density flux is continuous at the interface, i.e., $d_1 u_x(t, 0^-) = d_2 u_x(t, 0^+)$. Individuals at the interface may show a preference for one or the other patch type. We denote this preference by $\alpha \in (0, 1)$, where $\alpha > 0.5$ indicates a preference for patch 1 and $\alpha < 0.5$ for patch 2. Then the population density may be discontinuous at the interface with

$$(1 - \alpha)d_1 u(t, 0^-) = \alpha d_2 u(t, 0^+). \quad (1.73)$$

The discontinuity of the density at $x = 0$ creates some difficulties in the analysis of propagation phenomena in our equations. It turns out to be much easier to scale the equations so that the density is continuous; see [94] for details. Hence, in the subsection, we study the following two-patch problem:

$$\begin{cases} u_t = d_1 u_{xx} + f_1(u), & t > 0, x < 0, \\ u_t = d_2 u_{xx} + f_2(u), & t > 0, x > 0, \\ u(t, 0^-) = u(t, 0^+), & t > 0, \\ u_x(t, 0^-) = \sigma u_x(t, 0^+), & t > 0. \end{cases} \quad (1.74)$$

Here, the density is continuous across the interface but its derivative is not. The diffusion constants are assumed positive. Parameter $\sigma > 0$ is related to α , the probability that an individual at the interface chooses to move to patch 1. Please see Section 7.2.5 for more biological background and some interpretation of our results. Throughout this work, we shall assume that the functions f_i ($i = 1, 2$) are of class $C^1(\mathbb{R})$ and that

$$\exists 0 < K_i \leq K'_i, \quad f_i(0) = f_i(K_i) = 0, \quad \text{and} \quad f_i \leq 0 \text{ in } [K'_i, +\infty). \quad (1.75)$$

Our analysis and results will depend on a few characteristic properties of the functions f_i . We distinguish between the Fisher-KPP type (also KPP for short) and the bistable type. We give precise definitions of these properties below.

Our goal of this work is to study spreading properties and propagation vs. blocking phenomena for the solutions of this two-patch model for various combinations of the reaction terms. Specifically, we shall investigate

1. the asymptotic spreading properties of the solutions to the Cauchy problem with com-

pactly supported initial data when both reaction terms are of KPP type.

2. the conditions for the solutions to the Cauchy problem with compactly supported initial data to be blocked or to propagate with positive or zero speed when one reaction term is of KPP type and the other of bistable type. We shall also study the stability of the traveling wave in the bistable patch.
3. the asymptotic dynamics when both reaction terms are of bistable type.

Throughout the work, we set

$$I_1 = (-\infty, 0) \quad \text{and} \quad I_2 = (0, +\infty).$$

By a solution of the Cauchy problem (1.74) associated with a continuous bounded initial condition u_0 , we mean a classical solution in the following sense [94].

Definition 1.34. For $T \in (0, +\infty]$, we say that a continuous function $u : [0, T) \times \mathbb{R} \rightarrow \mathbb{R}$ is a classical solution of the Cauchy problem (1.74) in $[0, T) \times \mathbb{R}$ with an initial condition u_0 , if $u(0, \cdot) = u_0$ in \mathbb{R} , if $u|_{(0, T) \times \bar{I}_i} \in C^{1;2}_{t;x}((0, T) \times \bar{I}_i)$ ($i = 1, 2$), and if all identities in (1.74) are satisfied pointwise for $0 < t < T$.

Similarly, by a classical stationary solution of (1.74), we mean a continuous function $U : \mathbb{R} \rightarrow \mathbb{R}$ such that $U|_{\bar{I}_i} \in C^2(\bar{I}_i)$ ($i = 1, 2$) and all identities in (1.74) are satisfied pointwise, but without any dependence on t .

We also define super- and subsolutions as follows.

Definition 1.35. For $T \in (0, +\infty]$, we say that a continuous function $\bar{u} : [0, T) \times \mathbb{R} \rightarrow \mathbb{R}$, which is assumed to be bounded in $[0, T_0) \times \mathbb{R}$ for every $T_0 \in (0, T)$, is a supersolution of (1.74) in $[0, T) \times \mathbb{R}$, if $\bar{u}|_{(0, T) \times \bar{I}_i} \in C^{1;2}_{t;x}((0, T) \times \bar{I}_i)$ ($i = 1, 2$), if $\bar{u}_t(t, x) \geq d_i \bar{u}_{xx}(t, x) + f_i(\bar{u}(t, x))$ for all $i = 1, 2$, $0 < t < T$ and $x \in I_i$, and if

$$\bar{u}_x(t, 0^-) \geq \sigma \bar{u}_x(t, 0^+) \quad \text{for all } t \in (0, T).$$

A subsolution is defined in a similar way with all the inequality signs above reversed.

Existence results for the Cauchy problem associated with (1.74)

Proposition 1.36 (Well-posedness of the Cauchy problem associated with (1.74)). For any nonnegative bounded continuous function $u_0 : \mathbb{R} \rightarrow \mathbb{R}$, there is a unique nonnegative bounded classical solution u of (1.74) in $[0, +\infty) \times \mathbb{R}$ with initial condition u_0 such that, for any $\tau > 0$ and $A > 0$,

$$\|u|_{[\tau, +\infty) \times [-A, 0]}\|_{C^{1;\gamma;2;\gamma}_{t;x}([\tau, +\infty) \times [-A, 0])} + \|u|_{[\tau, +\infty) \times [0, A]}\|_{C^{1;\gamma;2;\gamma}_{t;x}([\tau, +\infty) \times [0, A])} \leq C,$$

1. General introduction

with a positive constant C depending on $\tau, A, d_{1,2}, f_{1,2}, \sigma$ and $\|u_0\|_{L^\infty(\mathbb{R})}$, and with a universal positive constant $\gamma \in (0, 1)$. Moreover, $u(t, x) > 0$ for all $(t, x) \in (0, +\infty) \times \mathbb{R}$ if $u_0 \not\equiv 0$. Lastly, the solutions depend monotonically and continuously on the initial data, in the sense that if $u_0 \leq v_0$ then the corresponding solutions satisfy $u \leq v$ in $[0, +\infty) \times \mathbb{R}$, and for any $T \in (0, +\infty)$ the map $u_0 \mapsto u$ is continuous from $C^+(\mathbb{R}) \cap L^\infty(\mathbb{R})$ to $C([0, T] \times \mathbb{R}) \cap L^\infty([0, T] \times \mathbb{R})$ equipped with the sup norms, where $C^+(\mathbb{R})$ denotes the set of nonnegative continuous functions in \mathbb{R} .

The existence in Proposition 1.36 can be proved by following the proof of [94, Theorem 2.2] and the uniqueness is a consequence of the following comparison principle stated in [94, Proposition A.3].

Proposition 1.37 (Comparison principle). *For $T \in (0, +\infty]$, let \bar{u} and \underline{u} be, respectively, a super- and a subsolution of (1.74) in $[0, T] \times \mathbb{R}$ in the sense of Definition 6.10, and assume that $\bar{u}(0, \cdot) \geq \underline{u}(0, \cdot)$ in \mathbb{R} . Then, $\bar{u} \geq \underline{u}$ in $[0, T] \times \mathbb{R}$ and, if $\bar{u}(0, \cdot) \not\equiv \underline{u}(0, \cdot)$, then $\bar{u} > \underline{u}$ in $(0, T) \times \mathbb{R}$.*

Propagation in the KPP-KPP case

We here investigate the spreading properties of the solutions to the Cauchy problem (1.74) associated with nonnegative, continuous and compactly supported initial conditions u_0 when f_i ($i = 1, 2$) in both patches I_i satisfy, in addition to (1.75), the KPP assumptions, that is,

$$f_i(0) = f_i(K_i) = 0, \quad 0 < f_i(s) \leq f'_i(0)s \text{ for all } s \in (0, K_i), \quad f'_i(K_i) < 0, \quad f_i < 0 \text{ in } (K_i, +\infty). \quad (1.76)$$

We call this configuration the KPP-KPP case. Without loss of generality, we assume that $K_1 \leq K_2$. In particular, if each function f_i satisfies (1.75) and is positive in $(0, K_i)$ and concave in $[0, +\infty)$, then (1.76) holds. An archetype is the logistic function $f_i(s) = s(1 - s/K_i)$.

We start with a Liouville-type result for the stationary problem associated with (1.74).

Proposition 1.38. *Under the assumption that*

$$f_i(0) = f_i(K_i) = 0, \quad f'_i(0) > 0, \quad f_i > 0 \text{ in } (0, K_i) \text{ and } f_i < 0 \text{ in } (K_i, +\infty), \quad (1.77)$$

with $0 < K_1 \leq K_2$, problem (1.74) admits a unique positive, bounded and classical stationary solution V . Furthermore, $V(-\infty) = K_1$, $V(+\infty) = K_2$, and $V' > 0$ in $(-\infty, 0^-] \cup [0^+, +\infty)$ if $K_1 < K_2$,⁵ while $V \equiv K_1$ in \mathbb{R} if $K_1 = K_2$.

⁵The notation $V' > 0$ in $(-\infty, 0^-] \cup [0^+, +\infty)$ means that $V|_{(-\infty, 0]}$ and $V|_{[0, +\infty)}$ have positive first-order derivatives in $(-\infty, 0]$ and $[0, +\infty)$ respectively.

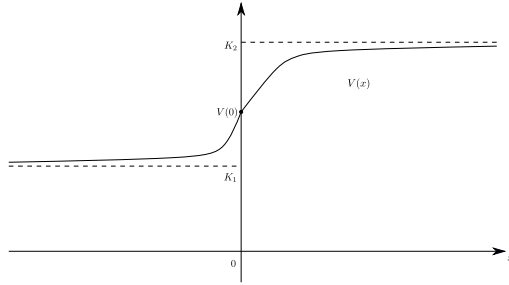

Figure 8: The profile of the unique positive stationary solution V in the KPP-KPP case.

The assumption (1.76) guarantees that the zero state is unstable with respect to any nontrivial perturbation, a phenomenon known from [9] as the hair-trigger effect for the homogeneous equation, and which holds here as well, as the following result shows:

Proposition 1.39. *Assume that (1.76) holds with $K_1 \leq K_2$. Then, the solution u of (1.74) with any nonnegative, bounded and continuous initial datum $u_0 \not\equiv 0$ satisfies:*

$$u(t, x) \rightarrow V(x) \quad \text{as } t \rightarrow +\infty, \text{ locally uniformly in } x \in \mathbb{R},$$

where V is the unique bounded continuous and classical stationary solution given in Proposition 1.38.

Our next main result in the KPP-KPP case is concerned with the spreading properties in both directions.

Theorem 1.40. *Assume that (1.76) holds and let V be as in Proposition 1.38. Then there exist leftward and rightward asymptotic spreading speeds, $c_1^* = 2\sqrt{d_1 f_1'(0)}$ and $c_2^* = 2\sqrt{d_2 f_2'(0)}$, respectively, such that the solution of (1.74) with any nonnegative, continuous and compactly supported initial condition $u_0 \not\equiv 0$ satisfies:*

$$\left\{ \begin{array}{l} \lim_{t \rightarrow +\infty} \left(\sup_{x \leq -(c_1^* + \varepsilon)t} u(t, x) \right) = \lim_{t \rightarrow +\infty} \left(\sup_{x \geq (c_2^* + \varepsilon)t} u(t, x) \right) = 0, \quad \text{for all } \varepsilon > 0, \\ \lim_{t \rightarrow +\infty} \left(\sup_{(-c_1^* + \varepsilon)t \leq x \leq (c_2^* - \varepsilon)t} |u(t, x) - V(x)| \right) = 0, \quad \text{for all } 0 < \varepsilon \leq \frac{c_1^* + c_2^*}{2}. \end{array} \right.$$

This theorem says that the level sets of $u(t, \cdot)$ behave as $2\sqrt{d_1 f_1'(0)}t$ in patch 1 and as $2\sqrt{d_2 f_2'(0)}t$ in patch 2 at large times, which is an analogue of the standard spreading result for the solutions to homogeneous KPP equations (see, e.g. [9]), as already mentioned in the introduction. This demonstrates that, in the KPP-KPP case, the spreading speeds are essentially determined by the property of the equation at infinity.

1. General introduction

Persistence, blocking or propagation in the KPP-bistable case

In this subsection, in addition to (1.75), we assume that f_1 is of KPP type, whereas f_2 is of bistable type, namely:

$$f_1(0) = f_1(K_1) = 0, \quad 0 < f_1(s) \leq f_1'(0)s \text{ for all } s \in (0, K_1), \quad f_1'(K_1) < 0, \quad f_1 < 0 \text{ in } (K_1, +\infty). \quad (1.78)$$

and

$$\begin{cases} f_2(0) = f_2(\theta) = f_2(K_2) = 0 \text{ for some } \theta \in (0, K_2), \\ f_2'(0) < 0, \quad f_2'(K_2) < 0, \quad f_2 < 0 \text{ in } (0, \theta) \cup (K_2, +\infty), \quad f_2 > 0 \text{ in } (\theta, K_2). \end{cases} \quad (1.79)$$

Let $\phi(x - c_2 t)$ be the unique traveling wave solution connecting K_2 to 0 for the equation $u_t = d_2 u_{xx} + f_2(u)$ viewed in the whole line \mathbb{R} , that is, $\phi : \mathbb{R} \rightarrow (0, K_2)$ satisfies

$$\begin{cases} d_2 \phi'' + c_2 \phi' + f_2(\phi) = 0, \quad \phi' < 0 \text{ in } \mathbb{R}, \\ \phi(-\infty) = K_2, \quad \phi(+\infty) = 0, \quad \phi(0) = \frac{K_2}{2}, \end{cases} \quad (1.80)$$

where the speed c_2 has the same sign as $\int_0^{K_2} f_2(s) ds$ [76]. The normalization condition $\phi(0) = K_2/2$ uniquely determines ϕ .

Persistence in the KPP patch 1

Before dealing with blocking or propagation in the bistable patch 2, we start with the following persistence and propagation result in the KPP patch 1. This result holds independently of the bistable profile in patch 2.

Theorem 1.41. *Assume that (1.78)–(1.79) hold. Let u be the solution of (1.74) with a nonnegative, continuous and compactly supported initial condition $u_0 \not\equiv 0$. Then, for every $\bar{x} \in \mathbb{R}$,*

$$\inf_{x \leq \bar{x}} \left(\liminf_{t \rightarrow +\infty} u(t, x) \right) > 0.$$

Moreover, u propagates to the left with speed $c_1^* = 2\sqrt{d_1 f_1'(0)}$ in the sense that

$$\begin{cases} \forall \varepsilon > 0, \quad \lim_{t \rightarrow +\infty} \left(\sup_{x \leq -(c_1^* + \varepsilon)t} u(t, x) \right) = 0, \\ \forall \varepsilon \in (0, c_1^*), \quad \forall \eta > 0, \quad \exists x_1 \in \mathbb{R}, \quad \limsup_{t \rightarrow +\infty} \left(\sup_{-(c_1^* - \varepsilon)t \leq x \leq x_1} |u(t, x) - K_1| \right) < \eta. \end{cases}$$

In particular, $\sup_{-ct \leq x \leq -c't} |u(t, x) - K_1| \rightarrow 0$ as $t \rightarrow +\infty$ for every $0 < c' \leq c < c_1^*$.

Remark 1.42. For u as in Theorem 1.41, denote by $\omega(u)$ the ω -limit set of u in the topology

1.4. Propagation phenomena in patchy landscapes with interface conditions

of $C_{loc}^2(\mathbb{R})$. Recall that a function w belongs to $\omega(u)$ if and only if there exists a sequence $(t_k)_{k \in \mathbb{N}}$ diverging to $+\infty$ such that $\lim_{k \rightarrow +\infty} u(t_k, \cdot) = w$ in $C_{loc}^2(\mathbb{R})$. Proposition 1.36 implies that $\omega(u)$ is not empty and Theorem 1.41 yields $w(-\infty) = K_1$ for any $w \in \omega(u)$. Moreover, one can also conclude that, for each $\varepsilon \in (0, c_1^*)$ and each map $t \mapsto \zeta(t)$ such that $\zeta(t) \rightarrow -\infty$ and $|\zeta(t)| = o(t)$ as $t \rightarrow +\infty$, it holds

$$\lim_{t \rightarrow +\infty} \sup_{-(c_1^* - \varepsilon)t \leq x \leq \zeta(t)} |u(t, x) - K_1| = 0.$$

Stationary solutions connecting K_1 and 0, or K_1 and K_2

The following Proposition 1.43 provides some necessary conditions for a stationary solution connecting K_1 and 0 to exist, whereas Proposition 1.44 gives some sufficient conditions for such a solution to exist. These solutions will act as blocking barriers in the bistable patch 2 for the solutions of (1.74) with “small” initial conditions in some sense (see Theorem 1.48).

Proposition 1.43. *Assume that (1.78)–(1.79) hold, and that (1.74) admits a nonnegative classical stationary solution U such that $U(-\infty) = K_1$ and $U(+\infty) = 0$. Then one of the following cases holds:*

(i) *if $\int_0^{K_2} f_2(s) ds < 0$, then $U' < 0$ in $(-\infty, 0^-] \cup [0^+, +\infty)$, $0 < U(0) < K_1$, and*

$$\int_{U(0)}^{K_1} f_1(s) ds = -\frac{d_1 \sigma^2}{d_2} \int_0^{U(0)} f_2(s) ds > 0; \quad (1.81)$$

(ii) *if $\int_0^{K_2} f_2(s) ds = 0$, then $U' < 0$ in $(-\infty, 0^-] \cup [0^+, +\infty)$, $0 < U(0) < \min(K_1, K_2)$, and (1.81) holds;*

(iii) *if $\int_0^{K_2} f_2(s) ds > 0$ and if $\theta^* \in (\theta, K_2)$ is such that $\int_0^{\theta^*} f_2(s) ds = 0$, then:*

(a) *either $U' < 0$ in $(-\infty, 0^-] \cup [0^+, +\infty)$ and $0 < U(0) < \min(K_1, \theta^*)$,*

(b) *or U is bump-like, that is, U is nondecreasing in $(-\infty, x_0)$ and U is decreasing in $(x_0, +\infty)$ for some $x_0 \geq 0$, with $U(x_0) = \max_{\mathbb{R}} U = \theta^*$ and $U'(x_0) = 0$. Furthermore, either $x_0 > 0$, $U' > 0$ in $(-\infty, 0^-] \cup [0^+, x_0)$, $K_1 < U(0) < \theta^*$ and $U' < 0$ in $(x_0, +\infty)$; or $x_0 = 0$, $K_1 = \theta^*$, $U \equiv K_1$ in $(-\infty, 0]$, and $U' < 0$ in $(0, +\infty)$.*

Proposition 1.44. *Assume that (1.78)–(1.79) hold. Then (1.74) admits a nonnegative classical stationary solution U such that $U(-\infty) = K_1$ and $U(+\infty) = 0$, provided one of the following holds:*

(i) $\int_0^{K_2} f_2(s) ds < 0$;

1. General introduction

(ii) $\int_0^{K_2} f_2(s)ds = 0$ and $K_1 < K_2$;

(iii) $\int_0^{K_2} f_2(s)ds > 0$ and $K_1 \leq \theta^*$, where $\theta^* \in (\theta, K_2)$ is such that $\int_0^{\theta^*} f_2(s)ds = 0$.

Proposition 1.44 is optimal in the sense that the parameters $d_{1,2}$ and σ are not involved. However, when $\int_0^{K_2} f_2(s)ds = 0$ and $K_1 \geq K_2$, or when $\int_0^{K_2} f_2(s)ds > 0$ and $K_1 > \theta^*$, it turns out that the stationary solution U of (1.74) such that $U(-\infty) = K_1$ and $U(+\infty) = 0$ may not exist, and then the parameters $f_{1,2}$, $d_{1,2}$ and σ play crucial roles (see the comments after the proof of Proposition 1.44 in Section 7.4.2 below for further details).

The third proposition, which will play a key-role in the large-time dynamics of the spreading solutions in patch 2, is the analogue of Proposition 1.38 in the present KPP-bistable framework, namely it is concerned with the stationary solutions of (1.74) connecting K_1 and K_2 .

Proposition 1.45. *Assume that (1.78)–(1.79) hold and that $\int_0^{K_2} f_2(s)ds \geq 0$. Then problem (1.74) has a unique, nonnegative, bounded and classical stationary solution V such that $V(-\infty) = K_1$ and $V(+\infty) = K_2$. Moreover, V is monotone in \mathbb{R} .*

Notice that the functions U and V given in Propositions 1.44 and 1.45 can exist simultaneously, since the sufficient conditions for the existence of U and V are not incompatible.

Blocking phenomena if patch 2 has bistable dynamics

We now turn to investigate blocking phenomena. If U is a stationary solution of (1.74) with $U(-\infty) = K_1$ and $U(+\infty) = 0$ and if the nonnegative bounded continuous initial condition u_0 satisfies $0 \leq u_0 \leq U$ in \mathbb{R} , then the comparison principle Proposition 1.37 implies that the solution u of the Cauchy problem (1.74) with initial condition u_0 satisfies $0 \leq u(t, x) \leq U(x)$ for all $(t, x) \in [0, +\infty) \times \mathbb{R}$, hence it is blocked in patch 2, that is,

$$u(t, x) \rightarrow 0 \text{ as } x \rightarrow +\infty, \text{ uniformly in } t \geq 0. \quad (1.82)$$

For another blocking result, we assume that $\int_0^{K_2} f_2(s)ds \leq 0$ and show that the traveling front solution $\phi(x - c_2 t)$ of (1.80) serves as a blocking barrier in patch 2.

Theorem 1.46. *Assume that (1.78)–(1.79) hold, and that $\int_0^{K_2} f_2(s)ds < 0$, or $\int_0^{K_2} f_2(s)ds = 0$ with $K_1 < K_2$. Let u be the solution of (1.74) with a nonnegative, continuous and compactly supported initial condition $u_0 \not\equiv 0$. Then, u is blocked in patch 2, that is, it satisfies (1.82).*

Furthermore, blocking can occur when K_1 and the $L^\infty(\mathbb{R})$ norm of u_0 are less than θ .

Theorem 1.47. *Assume that (1.78)–(1.79) hold and that $K_1 < \theta$. Let u be the solution of (1.74) with a nonnegative, continuous and compactly supported initial condition $u_0 \not\equiv 0$ such that $u_0 < \theta$ in \mathbb{R} . Then, u is blocked in patch 2, that is, it satisfies (1.82).*

Our last blocking result requires that the initial conditions u_0 is small in the $L^1(\mathbb{R})$ norm and that a classical stationary solution exists, connecting K_1 and 0.

Theorem 1.48. *Assume that (1.78)–(1.79) hold and that (1.74) admits a nonnegative classical stationary solution U with $U(-\infty) = K_1$ and $U(+\infty) = 0$. Then, for any $L > 0$, there is $\varepsilon > 0$ such that the following holds: for any nonnegative continuous initial condition u_0 whose support is included in $[-L, L]$ and which is such that $\|u_0\|_{L^1(\mathbb{R})} \leq \varepsilon$, the solution u of (1.74) with initial condition u_0 is blocked in patch 2, that is, it satisfies (1.82).*

Notice that, in contrast with Theorem 1.46 which is concerned with the case $\int_0^{K_2} f_2(s)ds \leq 0$, Theorems 1.47–1.48 show that blocking can also occur when $\int_0^{K_2} f_2(s)ds > 0$ (in particular, the existence of U in Theorem 1.48 can be fulfilled when $\int_0^{K_2} f_2(s)ds > 0$, as follows from Proposition 1.44).

Propagation with positive or zero speed when patch 2 has bistable dynamics

Finally, we turn to propagation results in patch 2. Our first result is motivated by the one-dimensional propagation result of Fife and McLeod [76]. They showed that solutions of the homogeneous Cauchy problem (1.74) with bistable nonlinearity (1.79) and compactly supported initial conditions spread with positive speed in both directions if (i) the initial conditions exceed θ on a large enough set and (ii) $\int_0^{K_2} f_2(s)ds > 0$.

Theorem 1.49. *Assume that (1.78)–(1.79) hold and that $\int_0^{K_2} f_2(s)ds > 0$. Let u be the solution of (1.74) with a nonnegative, continuous and compactly supported initial datum $u_0 \not\equiv 0$. Then, for any $\eta > 0$, there is $L > 0$ such that, if $u_0 \geq \theta + \eta$ on an interval of size L included in patch 2, then u propagates to the right with speed c_2 and, more precisely, there is $\xi \in \mathbb{R}$ such that*

$$\sup_{t \geq A, x \geq A} |u(t, x) - \phi(x - c_2 t + \xi)| \rightarrow 0 \quad \text{as } A \rightarrow +\infty, \quad (1.83)$$

where ϕ is the traveling front profile given by (1.80).

The result in the preceding theorem assumes some conditions on f_2 and u_0 . The following result shows that propagation can also occur independently of u_0 and under some slightly weaker assumptions on f_2 , provided no stationary solution connecting K_1 and 0 exists.

Theorem 1.50. *Assume that (1.78)–(1.79) hold and that $\int_0^{K_2} f_2(s)ds \geq 0$. If (1.74) has no nonnegative classical stationary solution U such that $U(-\infty) = K_1$ and $U(+\infty) = 0$, then the solution u of (1.74) with any nonnegative, continuous and compactly supported initial condition $u_0 \not\equiv 0$ propagates completely, namely,*

$$u(t, x) \rightarrow V(x) \quad \text{as } t \rightarrow +\infty, \quad \text{locally uniformly in } x \in \mathbb{R}, \quad (1.84)$$

1. General introduction

where V is the unique nonnegative classical stationary solution of (1.74) such that $V(-\infty) = K_1$ and $V(+\infty) = K_2$, given in Proposition 1.45. Furthermore,

- (i) if $\int_0^{K_2} f_2(s)ds > 0$, then u propagates to the right with speed $c_2 > 0$ in patch 2, and more precisely (1.83) holds for some $\xi \in \mathbb{R}$;
- (ii) if $\int_0^{K_2} f_2(s)ds = 0$, then u propagates to the right with speed zero in patch 2, in the sense that (1.84) holds and $\sup_{x \geq ct} u(t, x) \rightarrow 0$ as $t \rightarrow +\infty$ for every $c > 0$.

Remark 1.51. In the balanced case

$$\int_0^{K_2} f_2(s)ds = 0, \tag{1.85}$$

blocking in patch 2 can occur, as follows from Theorems 1.46–1.48. However, in contrast to the case $\int_0^{K_2} f_2(s)ds < 0$ (see Theorem 1.46), blocking is not guaranteed. Indeed, if (1.85) holds, Proposition 1.43 (ii) and Theorem 1.50 (ii) provide some sufficient conditions for the solution u of (1.74) to propagate to the right with speed zero. These conditions are fulfilled, for instance, when we replace f_2 in (1.79) with \tilde{f}_2 , where $f_2(s) = \tilde{f}_2(s/\varepsilon)$ and choose $\varepsilon > 0$ small enough while all other parameters are fixed. We give a heuristic explanation for this phenomenon. First, it follows from Proposition 1.44 that $K_1 \geq K_2$ under the assumptions of Theorem 1.50 (ii). Then, since $u(t, x)$ converges as $t \rightarrow +\infty$ locally uniformly in $x \in \mathbb{R}$ to the stationary solution V connecting K_1 and K_2 , the KPP patch provides exterior energy through the interface and forces the solution u to persist in patch 2 and then propagate with zero speed. A similar phenomenon, called “virtual blocking” or “virtual pinning”, was previously investigated in a one-dimensional heterogeneous bistable equation [124] and in the mean curvature equation in two-dimensional sawtooth cylinders [118]. It is also well known that for the homogeneous bistable equation, the solution u to the Cauchy problem with any nonnegative bounded compactly supported initial condition is blocked at large times and extinction occurs when (1.85) holds. In contrast, Theorem 1.50 states that, when (1.85) is fulfilled, the solution to the patch problem (1.74) with a compactly supported initial condition can still propagate into the bistable patch 2, but its level sets then move to the right with speed zero.

Remark 1.52. When the initial condition of the scalar homogeneous bistable equation is small in the $L^1(\mathbb{R})$ norm, then $\|u(1, \cdot)\|_{L^\infty(\mathbb{R})}$ can be bounded from above by a constant less than θ . Hence, extinction occurs and the blocking property (1.82) holds if the initial condition is compactly supported. In our work, due to the presence of the KPP patch 1 in (1.74), a small $L^1(\mathbb{R})$ norm of the initial condition is not sufficient to cause blocking for equations (1.74) in general, as follows from Theorems 1.49–1.50.

Blocking or propagation in the bistable-bistable case

In this subsection, we briefly show some extension of the results for the KPP-bistable case to the bistable-bistable case.

Assume that f_i ($i = 1, 2$) are of bistable type:

$$\begin{cases} f_i(0) = f_i(\theta_i) = f_i(K_i) = 0 \text{ for some } \theta_i \in (0, K_i), \\ f'_i(0) < 0, f'_i(K_i) < 0, f_i < 0 \text{ in } (0, \theta_i), f_i > 0 \text{ in } (\theta_i, K_i). \end{cases} \quad (1.86)$$

Let $\phi_i(-x \cdot e_i - c_i t)$ with $e_i = \pm 1$ ($i = 1, 2$) be the unique traveling waves connecting K_i to 0 for the equation $u_t = d_i u_{xx} + f_i(u)$ viewed in the whole line \mathbb{R} , that is, $\phi_i : \mathbb{R} \rightarrow (0, K_i)$ satisfies

$$\begin{cases} d_i \phi_i'' + c_i \phi_i' + f_i(\phi_i) = 0, \quad \phi_i' < 0 \text{ in } \mathbb{R}, \\ \phi_i(-\infty) = K_i, \quad \phi_i(+\infty) = 0, \quad \phi_i(0) = \theta_i, \end{cases} \quad (1.87)$$

where the speeds c_i have the sign of $\int_0^{K_i} f_i(s) ds$ [76] (the normalization condition $\phi(0) = K_i/2$ uniquely determine ϕ_i).

Stationary solutions connecting K_1 and 0, or K_1 and K_2

First of all, in the spirit of Proposition 1.43, we provide some necessary conditions such that a stationary solution connecting K_1 and 0 exists. Namely,

Proposition 1.53. *Assume that (1.86) holds and $\int_0^{K_1} f_1(s) ds \geq 0$, and that (1.74) admits a nonnegative classical stationary solution U such that $U(-\infty) = K_1$ and $U(+\infty) = 0$. Then one of the following cases holds true:*

(i) *If $\int_0^{K_2} f_2(s) ds < 0$, then $U' < 0$ in $(-\infty, 0^-] \cup [0^+, +\infty)$ and $0 < U(0) < K_1$, and*

$$\int_{U(0)}^{K_1} f_1(s) ds = -\frac{d_1 \sigma^2}{d_2} \int_0^{U(0)} f_2(s) ds > 0; \quad (1.88)$$

(ii) *If $\int_0^{K_2} f_2(s) ds = 0$, then $U' < 0$ in $(-\infty, 0^-] \cup [0^+, +\infty)$ and $0 < U(0) < \min(K_1, K_2)$, and (1.88) holds;*

(iii) *If $\int_0^{K_2} f_2(s) ds > 0$ and let $\theta_2^* \in (\theta_2, K_2)$ be such that $\int_0^{\theta_2^*} f_2(s) ds = 0$, then:*

(a) *either $U' < 0$ in $(-\infty, 0^-] \cup [0^+, +\infty)$ and $0 < U(0) < \min(K_1, \theta_2^*)$,*

(b) *or U is bump-like, that is, U is nondecreasing in $(-\infty, x_0)$ and U is decreasing in $(x_0, +\infty)$ for some $x_0 \geq 0$, with $U(x_0) = \max_{\mathbb{R}} U = \theta_2^*$ and $U'(x_0) = 0$. Furthermore, either $x_0 > 0$, $U' > 0$ in $(-\infty, 0^-] \cup [0^+, x_0)$, $K_1 < U(0) < \theta_2^*$ and*

1. General introduction

$U' < 0$ in $(x_0, +\infty)$; or $x_0 = 0$, $K_1 = \theta_2^*$, $U \equiv K_1$ in $(-\infty, 0]$, and $U' < 0$ in $(0, +\infty)$.

By a slight modification of the proof of Proposition 1.44, some sufficient conditions such that a stationary solution connecting K_1 and 0 exists are obtained as follows.

Proposition 1.54. *Assume that (1.86) holds and that $\int_0^{K_1} f_1(s)ds \geq 0$. Then (1.74) admits a nonnegative classical stationary solution U such that $U(-\infty) = K_1$ and $U(+\infty) = 0$, provided one of the following holds:*

- (i) $\int_0^{K_2} f_2(s)ds < 0$;
- (ii) $\int_0^{K_2} f_2(s)ds = 0$ and $K_1 < K_2$;
- (iii) $\int_0^{K_2} f_2(s)ds > 0$ and $K_1 \leq \theta_2^*$, where $\theta_2^* \in (\theta_2, K_2)$ is such that $\int_0^{\theta_2^*} f_2(s)ds = 0$.

Similar to Proposition 1.45, we also have:

Proposition 1.55. *Assume that (1.86) holds and that $\int_0^{K_i} f_i(s)ds \geq 0$ for $i = 1, 2$. Then problem (1.74) has a unique, nonnegative, bounded and classical stationary solution V such that $V(-\infty) = K_1$ and $V(+\infty) = K_2$. Moreover, V is monotone in \mathbb{R} .*

The strategy of the proof of Proposition 1.55 is very similar to that of Proposition 1.45, however, the argument in Step 2.1 this time should follow the idea of Step 2.2 due to the bistable assumption on f_1 .

Blocking phenomena

Following the lines as that of Theorem 1.46, one has:

Theorem 1.56. *Assume that (1.86) holds and let u be the solution of (1.74) with nonnegative, continuous and compactly supported initial function $u_0 \not\equiv 0$. Then,*

- (i) *if there is $i \in \{1, 2\}$ such that $\int_0^{K_i} f_i(s)ds < 0$, then u will be blocked in patch i , that is,*

$$u(t, x) \rightarrow 0 \text{ as } |x| \rightarrow +\infty \text{ in patch } i, \text{ uniformly in } t \geq 0;$$

- (ii) *if $\int_0^{K_1} f_1(s)ds > 0$ and $\int_0^{K_2} f_2(s)ds = 0$ with $K_1 < K_2$, then u is blocked in patch 2, that is, it satisfies (1.82). Furthermore, if for any $\eta > 0$, there is $L > 0$ such that $u_0 \geq \theta + \eta$ on an interval of size L included in patch 1, then u propagates to the left with speed c_1 and, more precisely, there is $\xi \in \mathbb{R}$ such that*

$$\sup_{t \geq A, x \leq -A} |u(t, x) - \phi_1(-x - c_1 t + \xi)| \rightarrow 0 \text{ as } A \rightarrow +\infty, \quad (1.89)$$

where ϕ_1 is the traveling front profile given by (1.87).

Finally, similar to Theorem 1.47, one has

Theorem 1.57. *Assume that (1.86) holds, $\int_0^{K_1} f_1(s)ds \geq 0$ and $K_1 < \theta_2$. Let u be the solution of (1.74) with nonnegative, continuous and compactly supported initial value $u_0 \not\equiv 0$ such that $u_0 < \theta_2$ in \mathbb{R} . Then u is blocked in patch 2, that is, it satisfies (1.82).*

From Theorem 1.48, it follows that

Theorem 1.58. *Assume that (1.86) holds and $\int_0^{K_1} f_1(s)ds \geq 0$, and that (1.74) admits a nonnegative classical stationary solution U such that $U(-\infty) = K_1$ and $U(+\infty) = 0$. Then, for any $L > 0$, there is $\varepsilon > 0$ such that the following holds: for any nonnegative continuous and compactly supported initial condition u_0 whose support is included in $[-L, L]$ and which is such that $\|u_0\|_{L^1(\mathbb{R})} \leq \varepsilon$, the solution u of (1.74) with initial condition u_0 is blocked in patch 2, that is, it satisfies (1.82).*

Propagation with positive or zero speed

The following theorems are concerned with propagation results. From Theorem 1.49, it is easy to see that:

Theorem 1.59. *Assume that (1.86) holds and that there is $i \in \{1, 2\}$ such that $\int_0^{K_i} f_i(s)ds > 0$. Let u be the solution of (1.74) with nonnegative, continuous and compactly supported initial function $u_0 \not\equiv 0$. Then, for any $\eta > 0$, there is $L > 0$ such that, if $u_0 \geq \theta_i + \eta$ on an interval of size L included in patch i , then u propagates in patch i with speed c_i and more precisely, there is $\xi_i \in \mathbb{R}$ such that*

$$\sup_{t \geq A, -x \cdot e_i \geq A} |u(t, x) - \phi_i(-x \cdot e_i - c_i t + \xi_i)| \rightarrow 0 \text{ as } A \rightarrow +\infty, \quad (1.90)$$

where ϕ_i is the traveling front profile given by (1.87).

Inspired from Theorem 1.50, we have

Theorem 1.60. *Assume that (1.86) holds and that $\int_0^{K_1} f_1(s)ds > 0$ and $\int_0^{K_2} f_2(s)ds \geq 0$. If (1.74) has no nonnegative classical stationary solution U such that $U(-\infty) = K_1$ and $U(+\infty) = 0$. Let u be the solution of (1.74) with nonnegative continuous and compactly supported initial datum $u_0 \not\equiv 0$. Then, for any $\eta > 0$, there is $L > 0$ such that, if $u_0 \geq \theta_1 + \eta$ on an interval of size L included in patch 1, then u propagates completely, namely,*

$$u(t, x) \rightarrow V(x) \text{ as } t \rightarrow +\infty, \text{ locally uniformly in } x \in \mathbb{R}, \quad (1.91)$$

where V is the unique nonnegative classical stationary solution of (1.74) such that $V(-\infty) = K_1$ and $V(+\infty) = K_2$, given in Proposition 1.55. Furthermore, u propagates to the left with speed c_1 and (1.90) with $i = 1$ holds true in patch 1, and the following holds true in patch 2:

1. General introduction

- (i) if $\int_0^{K_2} f_2(s)ds > 0$, then u propagates to the right with speed $c_2 > 0$, and more precisely (1.90) with $i = 2$ holds for some $\xi \in \mathbb{R}$;
- (ii) if $\int_0^{K_2} f_2(s)ds = 0$, then u propagates to the right with speed zero, in the sense that (1.84) holds and $\sup_{x \geq ct} u(t, x) \rightarrow 0$ as $t \rightarrow +\infty$ for every $c > 0$.

Biological interpretation and explanation

We briefly discuss our results from an ecological point of view here. We envision a landscape of two different characteristics, say a large wooded area and an adjacent open grassland area. We assume that the movement rates of individuals are small relative to landscape scale so that we can essentially consider each landscape type as infinitely large. In the first scenario (KPP–KPP), the population has its highest growth rate at low density in both patches. While the low-density growth rates and carrying capacities may differ between the two landscape types, the population will grow in each type from low densities to the carrying capacity. When introduced locally, the population will spread in both directions, and the speed of spread will approach the famous Fisher speed $2\sqrt{d_i f'_i(0)}$ in each patch. The interface will not stop the population advance unless it is completely impermeable. This would be the special case (that we excluded from our analysis) where an individual at the interface will choose one of the two habitat types with probability one, i.e., $\alpha = 0$ or $\alpha = 1$.

The second scenario (KPP–bistable) is more interesting. This time, the population dynamics change qualitatively from the highest growth rate being at low density to being at intermediate density. In ecological terms, this corresponds to a strong Allee effect and the threshold value θ is known as the Allee threshold. In this case, the interface can prevent a population that is spreading in the one habitat type (without Allee dynamic) from continuing to spread in the other type (with Allee dynamics). At first glance, it seems surprising that the conditions for propagation failure do not include parameter σ that reflects the movement behavior at the interface. To understand the reasons, we need to understand the scaling that led to system (1.74). The scaled reaction function f_2 and its unscaled counterpart, say \tilde{f}_2 , are related via

$$f_2(s) = k\tilde{f}_2(s/k), \quad k = \frac{\alpha}{1 - \alpha} \frac{d_2}{d_1},$$

see [94]. In particular, if \tilde{K}_2 and $\tilde{\theta}$ are the unscaled carrying capacity and Allee threshold, then $K_2 = k\tilde{K}_2$ and $\theta = k\tilde{\theta}$ are the corresponding scaled quantities. The sign of the integral that determines the sign of the speed of propagation in the homogeneous bistable equation does not change under this scaling. Hence, by choosing k large enough, one can satisfy the condition $K_1 < \theta$ in Theorem 1.47. A population that starts on a bounded set inside the KPP patch will be bounded by K_1 and therefore unable to spread in the Allee patch. Large values of k arise when the preference for patch 1 is high ($\alpha \approx 1$) or when the diffusion rate in the Allee patch is much larger than in the KPP patch. The mechanisms in this last scenario

is similar to that when a population spreads from an narrow into a wide region in two or three dimensions [49]. As individuals diffuse broadly, their density drops below the Allee threshold and the population cannot reproduce and spread.

A change in population dynamics from KPP to Allee effect need not be triggered by landscape properties, it can also be induced by management measures. For example, when male sterile insects are released in large enough densities, the probability of a female insect to meet a non-sterile male decreases substantially so that a mate-finding Allee effect may arise. The use of this technique to create barrier zones for insect pest spread has recently been explored by related but different means [3].

1.5 Open problems and perspectives

In this section, we would like to list several open problems and future research directions related to our work.

Problem 1. For the field-road model, we considered spatially periodic case. What about the spatial dynamics of this model under more general heterogeneity setting? For instance, in spatially and temporally periodic setting; in spatially and/or temporally almost-periodic setting, etc.

Problem 2. For the study of the funnel-shaped domains, we gave the propagation properties of the spreading solution in Theorem 1.19. Particularly, we showed that the level sets of spreading solution u is well approximated by the expanding spherical surface of radius $ct - ((N - 1)/c) \ln t + O(1)$ as $t \rightarrow +\infty$. Then, we wonder whether there exists a further precise characterization of the level sets of u . Would the shape of any level set of u be exactly a spherical surface for large times?

Problem 3. In funnel-shaped domains $\Omega_{R,\alpha}$, we conjecture that, under the assumptions of Theorem 1.23, the set of parameters (R, α) for which the solution u of (1.33) in $\Omega_{R,\alpha}$ with past condition (1.39) propagates completely is actually convex in both variables R and α , and that this property is stable by making α decrease or R increase. This conjecture can be formulated as follows.

Assume that the functions h given in (1.37)–(1.38) depend continuously on the parameters $(R, \alpha) \in (0, +\infty) \times (0, \pi/2)$ in the $C_{loc}^{2,\beta}(\mathbb{R})$ sense, with $0 < \beta < 1$. We say that complete propagation (resp. blocking) holds in $\Omega_{R,\alpha}$ if the solution u of (1.33) in $\Omega_{R,\alpha}$ with past condition (1.39) satisfies (1.46) (resp. (1.45)). Then,

- *for every $R > 0$, there is $\alpha_R \in (0, \pi/2]$ such that complete propagation holds in $\Omega_{R,\alpha}$ for all $\alpha \in (0, \alpha_R)$, and blocking holds for all $\alpha \in [\alpha_R, \pi/2)$ if $\alpha_R < \pi/2$;*
- *for every $\alpha \in (0, \pi/2)$, there is $\rho_\alpha \in [0, +\infty)$ such that complete propagation holds in $\Omega_{R,\alpha}$ for all $R > \rho_\alpha$, and blocking holds for all $R \in (0, \rho_\alpha]$ if $\rho_\alpha > 0$;*

1. General introduction

We give some observation here. Theorem 1.21 gives that α_R exists and $\alpha_R = \pi/2$ when $R \geq R_0$ (with the notations of Theorem 1.21). Furthermore, ρ_0 exists and $\rho_0 = 0$. On the other hand, Theorem 1.22 implies that, in dimension $N \geq 3$, for any given $\alpha_* \in (0, \pi/2)$ and $L_* > 0$, the angle α_R , if any, satisfies $\alpha_R \leq \alpha_*$ when $R \in (0, R_*]$ (with the notations of Theorem 1.22), and that ρ_α , if any, satisfies $\rho_\alpha \geq R_*$ when $\alpha \in [\alpha_*, \pi/2)$.

Problem 4. In the periodic patchy landscape, we wonder whether the spreading speed c^* derived in Theorem 1.30 has certain dependence on parameter σ , or even monotonicity, if possible, with respect to parameter σ (then with respect to parameter α).

Problem 5. In the periodic patchy landscape, the homogenization issues of (1.60)–(1.61) with rapidly oscillating coefficients and in slowly varying media, respectively, are open questions.

Problem 6. We wonder whether a sharp criterion of the initial condition for extinction vs. propagation holds true for the two-patch model (1.74).

This type of issue has drawn lots of attention from mathematicians in the past decades. We introduce the relevant references and give some comments below. Consider the homogeneous reaction-diffusion equation

$$u_t = u_{xx} + f(u), \quad t > 0, x \in \mathbb{R}. \quad (1.92)$$

Kanel' [107] considered the combustion nonlinearity (i.e., $f = 0$ in $[0, \theta] \cup \{1\}$ and $f > 0$ in $(\theta, 1)$ for some $0 < \theta < 1$) and showed that, for the particular family of initial conditions being characteristic functions of intervals (namely, $u_0 = \chi_{[-L, L]}$, with $L > 0$), there exist $0 < L_0 \leq L_1$ such that extinction occurs for $L < L_0$, while propagation occurs for $L > L_1$. This result was then extended by Aronson and Weinberger [8] to the bistable case (i.e. $f(0) = f(\theta) = f(1) = 0$ for some $\theta \in (0, 1)$, $f'(0) < 0$, $f'(1) < 0$, $f < 0$ in $(0, \theta)$, $f > 0$ in $(\theta, 1)$) with $\int_0^1 f(s)ds > 0$ (so-called bistable unbalanced case). Zlatoš [162] improved these results in combustion and unbalanced bistable cases by showing that $L_0 = L_1$. Du and Matano [61] generalized this sharp transition result for a wider class of one-parameter families of initial data. Moreover, they showed that the solutions to the Cauchy problem (1.92) with nonnegative bounded and compactly supported initial conditions always converge to a stationary solution of (1.92) as $t \rightarrow +\infty$ locally uniformly in $x \in \mathbb{R}$, and this limit turns out to be either a constant or a symmetrically decreasing stationary solution of (1.92). However, problem (1.74) has no translation invariance anymore due to the interface conditions at $x = 0$ and the reaction terms f_i and diffusion coefficients d_i which are different in general.

Chapter 2

Stability analysis and Hopf bifurcation at high Lewis number in a combustion model with free interface¹

2.1 Introduction

This paper is devoted to the stability analysis of a unique (up to translation) traveling wave solution to a thermo-diffusive model of flame propagation with stepwise temperature kinetics and first-order reaction (see [35]) at high Lewis numbers, namely $Le > 1$. The problem reads in one spatial dimension:

$$\begin{cases} \frac{\partial \Theta}{\partial t} = \frac{\partial^2 \Theta}{\partial x^2} + W(\Theta, \Phi), \\ \frac{\partial \Phi}{\partial t} = Le^{-1} \frac{\partial^2 \Phi}{\partial x^2} - W(\Theta, \Phi). \end{cases} \quad (2.1)$$

Here, Θ and Φ are appropriately normalized temperature and concentration of deficient reactant, $x \in \mathbb{R}$ denotes the spatial coordinate, $t > 0$ the time. The nonlinear term $W(\Theta, \Phi)$ is a scaled reaction rate given by (see [35, Section 2, formula (3)]):

$$W(\Theta, \Phi) = \begin{cases} A\Phi, & \text{if } \Theta \geq \Theta_i, \\ 0, & \text{if } \Theta < \Theta_i. \end{cases} \quad (2.2)$$

In (2.2), $0 < \Theta_i < 1$ is the reduced ignition temperature, $A > 0$ is a normalized factor depending on Θ_i and Le , to be determined hereafter for the purpose of ensuring that the speed of traveling wave is set at unity. Moreover, the following boundary conditions hold at

¹This is a joint work with Claude-Michel Brauner and Luca Lorenzi, published in *Ann. Inst. H. Poincaré Anal. Non linéaire* 37 (2020), 581-604.

2. Stability analysis and Hopf bifurcation in a combustion model

$\pm\infty$:

$$\begin{aligned}\Theta(t, -\infty) &= 1, & \Theta(t, \infty) &= 0, \\ \Phi(t, -\infty) &= 0, & \Phi(t, \infty) &= 1.\end{aligned}\tag{2.3}$$

In this first-order stepwise kinetics model, Φ does not vanish except as t tends to $-\infty$. Thus, problem (2.1)-(2.3) belongs to the class of parabolic Partial Differential Equations with discontinuous nonlinearities. Models in combustion theory and other fields (see, e.g. [2, Section 1]) involving discontinuous reaction terms have been used by physicists and engineers for long because of their manageability; as a result, elliptic and parabolic PDEs with discontinuous nonlinearities, and related Free Boundary Problems, have received a close attention from the mathematical community (see [1, Section 1] and references therein). We quote in particular the paper [48], by K.-C. Chang, which contains a systematical study of elliptic PDEs with discontinuous nonlinearities (DNDE).

In this paper, we consider the case of a free *ignition interface* $g(t)$ defined by

$$\Theta(t, g(t)) = \Theta_i,\tag{2.4}$$

such that $\Theta(t, x) > \Theta_i$ for $x > g(t)$ and $\Theta(t, x) < \Theta_i$ for $x < g(t)$. Formula (2.4) means that the ignition temperature Θ_i is reached at the ignition interface which defines the flame front. We point out that, in contrast to conventional Arrhenius kinetics where the reaction zone is infinitely thin, the reaction zone for stepwise temperature kinetics is of order unity (thick flame). It is also interesting to compare the first-order stepwise kinetics with the zero-order kinetics model (see [1, 35, 37]): in the zero-order kinetics, $\Phi(t, x)$ vanishes at a *trailing interface* and does not appear explicitly in the nonlinear term (see [35, Section 2, formula (4)]).

According to (2.4), the system for $\mathbf{X} = (\Theta, \Phi)$ reads as follows, for $t > 0$ and $x \in \mathbb{R}, x \neq g(t)$:

$$\begin{cases} \frac{\partial \Theta}{\partial t} = \frac{\partial^2 \Theta}{\partial x^2} + A\Phi, & x < g(t), \\ \frac{\partial \Phi}{\partial t} = \text{Le}^{-1} \frac{\partial^2 \Phi}{\partial x^2} - A\Phi, & x < g(t), \end{cases}\tag{2.5}$$

$$\begin{cases} \frac{\partial \Theta}{\partial t} = \frac{\partial^2 \Theta}{\partial x^2}, & x > g(t), \\ \frac{\partial \Phi}{\partial t} = \text{Le}^{-1} \frac{\partial^2 \Phi}{\partial x^2}, & x > g(t). \end{cases}\tag{2.6}$$

At the free interface $x = g(t)$, the following continuity conditions hold:

$$[\Theta] = [\Phi] = 0, \quad \left[\frac{\partial \Theta}{\partial x} \right] = \left[\frac{\partial \Phi}{\partial x} \right] = 0, \quad (2.7)$$

where we denote by $[f]$ the jump of a function f at a point x_0 , i.e., the difference $f(x_0^+) - f(x_0^-)$.

The system above admits a unique (up to translation) traveling wave solution $\mathbf{U} = (\Theta^0, \Phi^0)$ which propagates with constant positive velocity V . In the moving frame coordinate $z = x - Vt$, by choosing

$$A = \frac{\Theta_i}{1 - \Theta_i} \left(1 + \frac{\Theta_i}{\text{Le}(1 - \Theta_i)} \right), \quad (2.8)$$

to have $V = 1$ and, hence, $z = x - t$, the traveling wave solution is explicitly given by the following formulae:

$$\Theta^0(z) = \begin{cases} 1 - (1 - \Theta_i)e^{\frac{\Theta_i}{1-\Theta_i}z}, & z < 0, \\ \Theta_i e^{-z}, & z > 0, \end{cases}$$

$$\Phi^0(z) = \begin{cases} \frac{\Theta_i}{A(1 - \Theta_i)} e^{\frac{\Theta_i}{1-\Theta_i}z}, & z < 0, \\ 1 + \left(\frac{\Theta_i}{A(1 - \Theta_i)} - 1 \right) e^{-\text{Le}z}, & z > 0. \end{cases}$$

The goal of this paper is the analysis of the stability of the traveling wave solution \mathbf{U} in the case of high Lewis numbers ($\text{Le} > 1$). Here, stability refers to orbital stability with asymptotic phase, because of the translation invariance of the traveling wave. It is known (see [35, Section 3.2]) that large enough Lewis numbers give rise to *pulsating instabilities*, i.e., oscillatory behavior of the flame. This is very unlike *cellular instabilities* for relatively small Lewis number ($\text{Le} < 1$), that is pattern formation; in the latter case, a paradigm for the evolution of the disturbed flame front is the Kuramoto-Sivashinsky equation (see [126, 148], and also [38, 39, 40, 41, 44]).

The paper is organized as follows: In Section 2.2, we first transform the free interface problem to a system of parabolic equations on a fixed domain. Then, in the spirit of [42, 115, 116], the perturbation \mathbf{u} of the traveling wave \mathbf{U} is split as $\mathbf{u} = s \frac{d\mathbf{U}}{d\xi} + \mathbf{v}$ (“ansatz 1”), in which s is the perturbation of the front g . The largest part of the section is devoted to a thorough study of the linearization at 0 of the elliptic part of the parabolic system in a weighted space \mathbf{W} where its realization L is sectorial (see Subsection 2.2.3 for further details about the use of a weighted space). Furthermore, we determine the spectrum of L which contains $(-\infty, -\frac{1}{4}]$, a parabola and its interior, the roots of the so-called dispersion relation,

2. Stability analysis and Hopf bifurcation in a combustion model

and the eigenvalue 0. Thereafter, an important point is to get rid of the eigenvalue 0 which, as it has been already stressed, is generated by translation invariance. In Section 2.3, we use a spectral projection P as well as “ansatz 2” and then derive the fully nonlinear problem (see, e.g. [119]) for \mathbf{w} :

$$\frac{\partial \mathbf{w}}{\partial \tau} = (I - P)L\mathbf{w} + F(\mathbf{w}).$$

Next, in Sections 2.4 and 2.5 we use the bifurcation parameter m defined by

$$m := \frac{\Theta_i}{1 - \Theta_i}$$

to investigate the stability of the traveling wave. Simultaneously, as one already noted that pulsating instability is likely to occur at large Lewis number, it is natural to introduce a small perturbation parameter $\varepsilon > 0$ (dimensionless diffusion coefficient) defined by $\varepsilon := \text{Le}^{-1}$, so that (2.8) reads $A = m + \varepsilon m^2$. The simplest situation arises in the asymptotic case of gasless combustion when $\text{Le} = \infty$, as in [79]. As it is easily seen, as $\varepsilon \rightarrow 0$, problem (2.5)-(2.6) converges formally to:

$$\begin{cases} \frac{\partial \Theta}{\partial t} = \frac{\partial^2 \Theta}{\partial x^2} + A\Phi, & x < g(t), \\ \frac{\partial \Phi}{\partial t} = -A\Phi, & x < g(t), \end{cases} \quad (2.9)$$

$$\begin{cases} \frac{\partial \Theta}{\partial t} = \frac{\partial^2 \Theta}{\partial x^2}, & x > g(t), \\ \Phi \equiv 1, & x > g(t), \end{cases} \quad (2.10)$$

with conditions $[\Theta] = [\Phi] = 0$, $\left[\frac{\partial \Theta}{\partial x}\right] = 0$ at the free interface $x = g(t)$. However, the limit free interface system (2.9)-(2.10) is only partly parabolic.

At the outset, we fix m in Section 2.4 and let ε tend to 0, which allows to apply the classical Hurwitz Theorem in complex analysis to the *dispersion relation* $D_\varepsilon(\lambda, m)$. Our first main result, Theorem 2.6, states that, for $2 < m < m^c = 6$ and $0 < \varepsilon < \varepsilon_0(m)$, the traveling wave \mathbf{U} is orbitally stable with asymptotic phase and, for $m > m^c = 6$, it is unstable. To give a broad picture, we take advantage of the regular convergence of the point spectrum as $\varepsilon \rightarrow 0$.

Section 2.5 is devoted to the proof of Hopf bifurcation in a neighborhood of the critical value $m^c = 6$. The difficulty is twofold: first, the framework is that of a fully nonlinear problem; second, m is not fixed in the sequence of parameterized analytic functions $D_\varepsilon(\lambda, m)$ which prevents us from using Hurwitz Theorem directly. The trick is to find a proper approach to combining m with ε : to this end we construct a sequence of critical values $m^c(\varepsilon)$ such that $m^c(0) = m^c$ and apply Hurwitz Theorem to $D_\varepsilon(\lambda, m^c(\varepsilon))$. Proposition 2.7 and Theorem 2.9

are crucial to prove Hopf bifurcation at $m^c(\varepsilon)$ for ε small enough. Finally, in three appendices, we collect some formulae and results that we use to prove our main results.

2.2 The linearized operator

In this section, we first derive the governing equations for the perturbations of the traveling wave solution. As usual, it is convenient to transform the free interface problem to a system on a fixed domain. More specifically, we use the general method of [42] that converts free interface problems to fully nonlinear problems with transmission conditions at a fixed interface (see [1]). Then, we are going to focus on the linearized system.

2.2.1 The system with fixed interface

To begin with, we rewrite problem (2.5)-(2.7) in a new system of coordinates that fixes the position of the ignition interface at the origin:

$$\tau = t, \quad \xi = x - g(\tau).$$

Hereafter, we are going to use, whenever it is convenient, the superdot to denote differentiation with respect to time and the prime to denote partial differentiation with respect to the space variable.

Then, the system for $\mathbf{X} = (\Theta, \Phi)$ and g reads:

$$\begin{cases} \frac{\partial \Theta}{\partial \tau} - \dot{g} \frac{\partial \Theta}{\partial \xi} = \frac{\partial^2 \Theta}{\partial \xi^2} + A\Phi, & \xi < 0, \\ \frac{\partial \Phi}{\partial \tau} - \dot{g} \frac{\partial \Phi}{\partial \xi} = \text{Le}^{-1} \frac{\partial^2 \Phi}{\partial \xi^2} - A\Phi, & \xi < 0, \end{cases} \quad (2.11)$$

$$\begin{cases} \frac{\partial \Theta}{\partial \tau} - \dot{g} \frac{\partial \Theta}{\partial \xi} = \frac{\partial^2 \Theta}{\partial \xi^2}, & \xi > 0, \\ \frac{\partial \Phi}{\partial \tau} - \dot{g} \frac{\partial \Phi}{\partial \xi} = \text{Le}^{-1} \frac{\partial^2 \Phi}{\partial \xi^2}, & \xi > 0. \end{cases} \quad (2.12)$$

Moreover, Θ , Φ and their first-order space derivatives are continuous at the fixed interface $\xi = 0$, thus

$$\Theta(\cdot, 0) = \Theta_i, \quad [\Theta] = [\Phi] = 0, \quad \left[\frac{\partial \Theta}{\partial \xi} \right] = \left[\frac{\partial \Phi}{\partial \xi} \right] = 0. \quad (2.13)$$

In addition, at $\xi = \pm\infty$, Θ and Φ satisfy (2.3).

Next, we introduce the small perturbations $\mathbf{u} = (u_1, u_2)$ and s , respectively of the traveling

2. Stability analysis and Hopf bifurcation in a combustion model

wave \mathbf{U} and of the front g , more precisely,

$$\begin{aligned} u_1(\tau, \xi) &= \Theta(\tau, \xi) - \Theta^0(\xi), \\ u_2(\tau, \xi) &= \Phi(\tau, \xi) - \Phi^0(\xi), \\ s(\tau) &= g(\tau) - \tau. \end{aligned}$$

It then follows that the perturbations \mathbf{u} and s verify the system

$$\begin{cases} \frac{\partial u_1}{\partial \tau} = \frac{\partial^2 u_1}{\partial \xi^2} + \frac{\partial u_1}{\partial \xi} + Au_2 + \dot{s} \frac{d\Theta^0}{d\xi} + \dot{s} \frac{\partial u_1}{\partial \xi}, & \xi < 0, \\ \frac{\partial u_2}{\partial \tau} = \text{Le}^{-1} \frac{\partial^2 u_2}{\partial \xi^2} + \frac{\partial u_2}{\partial \xi} - Au_2 + \dot{s} \frac{d\Phi^0}{d\xi} + \dot{s} \frac{\partial u_2}{\partial \xi}, & \xi < 0, \end{cases} \quad (2.14)$$

$$\begin{cases} \frac{\partial u_1}{\partial \tau} = \frac{\partial^2 u_1}{\partial \xi^2} + \frac{\partial u_1}{\partial \xi} + \dot{s} \frac{d\Theta^0}{d\xi} + \dot{s} \frac{\partial u_1}{\partial \xi}, & \xi > 0, \\ \frac{\partial u_2}{\partial \tau} = \text{Le}^{-1} \frac{\partial^2 u_2}{\partial \xi^2} + \frac{\partial u_2}{\partial \xi} + \dot{s} \frac{d\Phi^0}{d\xi} + \dot{s} \frac{\partial u_2}{\partial \xi}, & \xi > 0, \end{cases} \quad (2.15)$$

and the corresponding interface conditions obtained from (2.13) are:

$$u_1(\tau, 0) = 0, \quad [u_1] = [u_2] = \left[\frac{\partial u_1}{\partial \xi} \right] = \left[\frac{\partial u_2}{\partial \xi} \right] = 0. \quad (2.16)$$

2.2.2 Ansatz 1

In the spirit of [42, 115], we introduce the following splitting or ansatz:

$$\begin{aligned} u_1(\tau, \xi) &= s(\tau) \frac{d\Theta^0}{d\xi}(\xi) + v_1(\tau, \xi), \\ u_2(\tau, \xi) &= s(\tau) \frac{d\Phi^0}{d\xi}(\xi) + v_2(\tau, \xi), \end{aligned} \quad (2.17)$$

in which v_1, v_2 are new unknown functions. In a more abstract setting, the ansatz reads

$$\mathbf{u}(\tau, \xi) = s(\tau) \frac{d\mathbf{U}}{d\xi} + \mathbf{v}(\tau, \xi), \quad \mathbf{v} = (v_1, v_2).$$

Substituting (2.17) into (2.14)-(2.15), we get the system for \mathbf{u} and s :

$$\begin{cases} \frac{\partial v_1}{\partial \tau} = \frac{\partial^2 v_1}{\partial \xi^2} + \frac{\partial v_1}{\partial \xi} + Av_2 + \dot{s} \left(s \frac{d^2 \Theta^0}{d\xi^2} + \frac{\partial v_1}{\partial \xi} \right), & \xi < 0, \\ \frac{\partial v_2}{\partial \tau} = \text{Le}^{-1} \frac{\partial^2 v_2}{\partial \xi^2} + \frac{\partial v_2}{\partial \xi} - Av_2 + \dot{s} \left(s \frac{d^2 \Phi^0}{d\xi^2} + \frac{\partial v_2}{\partial \xi} \right), & \xi < 0, \end{cases} \quad (2.18)$$

$$\begin{cases} \frac{\partial v_1}{\partial \tau} = \frac{\partial^2 v_1}{\partial \xi^2} + \frac{\partial v_1}{\partial \xi} + \dot{s} \left(s \frac{d^2 \Theta^0}{d\xi^2} + \frac{\partial v_1}{\partial \xi} \right), & \xi > 0, \\ \frac{\partial v_2}{\partial \tau} = \text{Le}^{-1} \frac{\partial^2 v_2}{\partial \xi^2} + \frac{\partial v_2}{\partial \xi} + \dot{s} \left(s \frac{d^2 \Phi^0}{d\xi^2} + \frac{\partial v_2}{\partial \xi} \right), & \xi > 0. \end{cases} \quad (2.19)$$

At $\xi = 0$, it is easy to see that the new interface conditions are:

$$[v_1] = [v_2] = 0, \quad \left[\frac{\partial v_1}{\partial \xi} \right] = -s \left[\frac{d^2 \Theta^0}{d\xi^2} \right], \quad \left[\frac{\partial v_2}{\partial \xi} \right] = -s \left[\frac{d^2 \Phi^0}{d\xi^2} \right], \quad v_1(\tau, 0) = -s \frac{\partial \Theta^0}{\partial \xi}(0).$$

Taking advantage of the conditions

$$\frac{d\Theta^0}{d\xi}(0) = -\Theta_i, \quad \left[\frac{d^2 \Theta^0}{d\xi^2} \right] = \frac{\Theta_i}{1 - \Theta_i}, \quad \left[\frac{d^2 \Phi^0}{d\xi^2} \right] = -\frac{\text{Le}\Theta_i}{1 - \Theta_i},$$

where we used (2.8) to derive the last condition, it follows that

$$s(\tau) = \frac{v_1(\tau, 0)}{\Theta_i}, \quad \left[\frac{\partial v_1}{\partial \xi} \right] = -\frac{v_1(\tau, 0)}{1 - \Theta_i}, \quad \left[\frac{\partial v_2}{\partial \xi} \right] = \frac{v_1(\tau, 0)\text{Le}}{1 - \Theta_i}. \quad (2.20)$$

Summarizing, the free interface problem (2.5)-(2.6) has been converted to (2.14)-(2.15), which constitutes a nonlinear system for v_1 , v_2 and s , with transmission conditions (2.20) at $\xi = 0$. The next subsections are devoted to the study of the linearized problem (at zero) in an abstract setting, with simplified notation $\mathbf{u} = (u, v)$ for convenience.

2.2.3 The linearized problem

Now, we consider the linearization at 0 of the system (2.18)-(2.20), which reads as follows:

$$\begin{cases} \frac{\partial u}{\partial \tau} = \frac{\partial^2 u}{\partial \xi^2} + \frac{\partial u}{\partial \xi} + Av, & \xi < 0, \\ \frac{\partial v}{\partial \tau} = \text{Le}^{-1} \frac{\partial^2 v}{\partial \xi^2} + \frac{\partial v}{\partial \xi} - Av, & \xi < 0, \end{cases} \quad (2.21)$$

$$\begin{cases} \frac{\partial u}{\partial \tau} = \frac{\partial^2 u}{\partial \xi^2} + \frac{\partial u}{\partial \xi}, & \xi > 0, \\ \frac{\partial v}{\partial \tau} = \text{Le}^{-1} \frac{\partial^2 v}{\partial \xi^2} + \frac{\partial v}{\partial \xi}, & \xi > 0, \end{cases} \quad (2.22)$$

with the interface conditions

$$[u] = [v] = 0, \quad \left[\frac{\partial u}{\partial \xi} \right] = -\frac{u(\tau, 0)}{1 - \Theta_i}, \quad \left[\frac{\partial v}{\partial \xi} \right] = \frac{u(\tau, 0)\text{Le}}{1 - \Theta_i}. \quad (2.23)$$

Problem (2.21)-(2.22) can be written in the more compact form $\frac{\partial \mathbf{u}}{\partial \tau} = \mathcal{L}\mathbf{u}$, where $\mathbf{u} = (u, v)$,

$$\mathcal{L} = \begin{pmatrix} \frac{\partial^2}{\partial \xi^2} + \frac{\partial}{\partial \xi} & A\chi_- \\ 0 & \text{Le}^{-1} \frac{\partial^2}{\partial \xi^2} + \frac{\partial}{\partial \xi} - A\chi_- \end{pmatrix}$$

and χ_- denotes the characteristic function of the set $(-\infty, 0)$.

We now introduce the weighted space \mathcal{W} where we analyze the system (2.21)-(2.23). As a matter of fact, the introduction of exponentially weighted spaces for proving stability of traveling waves has been a standard tool since the pioneering work of Sattinger (see [142]), its role being to shift the continuous spectrum to the left and, thus, creating a gap with the imaginary axis which simplifies the analysis.

Definition 2.1. *The exponentially weighted Banach space \mathcal{W} is defined by*

$$\mathcal{W} = \left\{ \mathbf{u} : e^{\frac{1}{2}\xi}u, e^{\frac{1}{2}\xi}v \in C_b((-\infty, 0); \mathbb{C}), e^{\frac{1}{2}\xi}u, e^{\frac{\text{Le}}{2}\xi}v \in C_b((0, \infty); \mathbb{C}), \lim_{\xi \rightarrow 0^\pm} u(\xi), \lim_{\xi \rightarrow 0^\pm} v(\xi) \in \mathbb{R} \right\},$$

equipped with the norm:

$$\|\mathbf{u}\|_{\mathcal{W}} = \sup_{\xi < 0} |e^{\frac{1}{2}\xi}u(\xi)| + \sup_{\xi > 0} |e^{\frac{1}{2}\xi}u(\xi)| + \sup_{\xi < 0} |e^{\frac{1}{2}\xi}v(\xi)| + \sup_{\xi > 0} |e^{\frac{\text{Le}}{2}\xi}v(\xi)|.$$

In the above definition, $C_b(I; \mathbb{C})$ denotes the space of bounded and continuous functions

from I to \mathbb{C} , I being either the interval $(-\infty, 0)$ or $(0, \infty)$. We finally introduce the realization L of the operator \mathcal{L} in \mathcal{W} defined by

$$D(L) = \left\{ \mathbf{u} \in \mathcal{W} : \frac{\partial \mathbf{u}}{\partial \xi}, \frac{\partial^2 \mathbf{u}}{\partial \xi^2} \in \mathcal{W}, [u] = [v] = 0, \left[\frac{\partial u}{\partial \xi} \right] = -\frac{u(0)}{1 - \Theta_i}, \left[\frac{\partial v}{\partial \xi} \right] = \frac{\text{Le } u(0)}{1 - \Theta_i} \right\},$$

$$L\mathbf{u} = \mathcal{L}\mathbf{u}, \quad \mathbf{u} \in \mathcal{W}.$$

Remark 2.2. We observe that, for any Lewis number, the pair $\frac{d\mathbf{U}}{d\xi} = \left(\frac{d\Theta^0}{d\xi}, \frac{d\Phi^0}{d\xi} \right)$ verifies System (2.21), (2.22), and it belongs to the space \mathcal{W} . In other words, $\frac{d\mathbf{U}}{d\xi}$ is an eigenfunction of the operator L associated with the eigenvalue 0.

The above remark gives a first justification for the choice of the exponential weights in the definition of \mathcal{W} . We also stress that, following the same strategy as in the proof of the forthcoming Theorem 2.3 it can be easily checked that the spectrum of the realization of the operator \mathcal{L} in the nonweighted space of pairs (u, v) such that u, v are bounded and continuous in $(-\infty, 0) \cup (0, \infty)$, contains a parabola which is tangent at 0 to the imaginary axis.

2.2.4 Analysis of the operator L

Next theorem is devoted to a deep study of the operator L . For simplicity of notation, for $j = 1, 2$ we set

$$H_{1,\lambda} = \sqrt{1 + 4\lambda}, \quad H_{2,\lambda} = \sqrt{\text{Le}^2 + 4\text{Le}(A + \lambda)}, \quad H_{3,\lambda} = \sqrt{\text{Le}^2 + 4\text{Le}\lambda} \quad (2.24)$$

and

$$k_{j,\lambda} = \frac{-1 + (-1)^{j+1}H_{1,\lambda}}{2}, \quad k_{2+j,\lambda} = \frac{-\text{Le} + (-1)^{j+1}H_{2,\lambda}}{2}, \quad k_{4+j,\lambda} = \frac{-\text{Le} + (-1)^{j+1}H_{3,\lambda}}{2}. \quad (2.25)$$

Theorem 2.3. *The operator L is sectorial and therefore generates an analytic semigroup. Moreover, its spectrum has components:*

(1) $(-\infty, -1/4] \cup \mathcal{P}$, where $\mathcal{P} = \{\lambda \in \mathbb{C} : a \text{Re } \lambda + b(\text{Im } \lambda)^2 + c \leq 0\}$ with

$$a = \left(1 - \frac{1}{\text{Le}}\right)^2, \quad b = \frac{1}{\text{Le}}, \quad c = \frac{2A + 1}{2} + \frac{8A - 5}{4\text{Le}} + \frac{1 + A}{\text{Le}^2} - \frac{1}{4\text{Le}^3};$$

(2) the simple isolated eigenvalue 0, the kernel of L being spanned by $\frac{d\mathbf{U}}{d\xi}$;

2. Stability analysis and Hopf bifurcation in a combustion model

(3) *additional eigenvalues given by the solution of the dispersion relation*

$$D(\lambda; \Theta_i, \text{Le}) := (k_{6,\lambda} - k_{3,\lambda})(k_{3,\lambda} - k_{2,\lambda})[1 - (1 - \Theta_i)\sqrt{1 + 4\lambda}] + A\text{Le}, \quad (2.26)$$

where A is given by (2.8).

Proof. Since the proof is rather lengthy, we split it into four steps. In the first two steps, we prove properties (1) and (3). Step 3 is devoted to the proof of property (2). Finally, in Step 4, we prove that the operator L is sectorial in \mathcal{W} .

For notational convenience, throughout the proof, we set

$$\begin{aligned} \mathcal{J}_1 &:= \int_0^\infty f_1(s)e^{-k_1s} ds, & \mathcal{J}_2 &:= \int_{-\infty}^0 f_1(s)e^{-k_2s} ds, & \mathcal{J}_3 &:= \int_{-\infty}^0 f_2(s)e^{-k_2s} ds, \\ \mathcal{J}_4 &:= \int_{-\infty}^0 f_2(s)e^{-k_4s} ds, & \mathcal{J}_5 &:= \int_0^\infty f_2(s)e^{-k_5s} ds, \end{aligned}$$

for any fixed $\mathbf{f} = (f_1, f_2) \in \mathcal{W}$, where, here and Step 1 to 3, we simply write k_j instead of $k_{j,\lambda}$ to enlighten the notation.

Step 1. To begin with, we prove that the interval $(-\infty, -1/4]$ belongs to the point spectrum of L . We first assume that $\lambda \leq -\text{Le}/4$ (recall that $\text{Le} > 1$). In such a case, $\text{Re}(k_1) = \text{Re}(k_2) = -1/2$, $\text{Re}(k_5) = \text{Re}(k_6) = -\text{Le}/2$ and the function \mathbf{u} defined by

$$u(\xi) = \begin{cases} c_1 e^{k_1 \xi} + c_2 e^{k_2 \xi}, & \xi < 0, \\ c_5 e^{k_1 \xi} + c_6 e^{k_2 \xi}, & \xi \geq 0, \end{cases} \quad v(\xi) = \begin{cases} 0, & \xi < 0, \\ c_7 e^{k_5 \xi} + c_8 e^{k_6 \xi}, & \xi \geq 0, \end{cases} \quad (2.27)$$

belongs to \mathcal{W} and solves the equation $\lambda \mathbf{u} - \mathcal{L}\mathbf{u} = \mathbf{0}$ for any choice of the complex parameters c_1, c_2, c_5, c_6, c_7 and c_8 . Since there are only four boundary conditions to impose to guarantee that $\mathbf{u} \in D(L)$, the resolvent equation $\lambda \mathbf{u} - \mathcal{L}\mathbf{u} = \mathbf{0}$ is not uniquely solvable in \mathcal{W} . Thus, λ belongs to the point spectrum of L .

Next, we consider the case when $\lambda \in (-\text{Le}/4, -1/4]$. In this situation, $\text{Re}(k_1) = \text{Re}(k_2) = -1/2$, however, $\text{Re}(k_5) + \text{Le}/2 > 0$, $\text{Re}(k_6) + \text{Le}/2 < 0$. Thanks to the fact that $e^{\frac{\text{Le}}{2}\xi}v(\xi)$ should be bounded in $(0, \infty)$, the constant c_7 in (2.27) is zero, whereas the constants c_1, c_2, c_5, c_6, c_8 are arbitrary. As above, the resolvent equation $\lambda \mathbf{u} - \mathcal{L}\mathbf{u} = \mathbf{0}$ cannot be solved uniquely. Consequently, we conclude that $(-\infty, -1/4]$ belongs to the point spectrum of the operator L .

From now on, we consider the case when $\lambda \notin (-\infty, -1/4]$. Then, $\text{Re}(k_1) + 1/2 > 0$, $\text{Re}(k_2) + 1/2 < 0$, $\text{Re}(k_5) + \text{Le}/2 > 0$ and $\text{Re}(k_6) + \text{Le}/2 < 0$. Similarly to the previous procedure, using the formulae (2.58), (2.59) and (2.56) as well as the fact that the functions $\xi \mapsto e^{\frac{1}{2}\xi}u(\xi)$ and $\xi \mapsto e^{\frac{\text{Le}}{2}\xi}v(\xi)$ should be bounded in \mathbb{R} and in $(0, \infty)$ respectively, the

constants c_2, c_5, c_7 can be determined explicitly and they are given by

$$c_2 = \frac{1}{H_{1,\lambda}} \int_{-\infty}^0 (Av(s) + f_1(s))e^{-k_2s} ds, \quad c_5 = \frac{1}{H_{1,\lambda}} \mathcal{J}_1, \quad c_7 = \frac{\text{Le}}{H_{3,\lambda}} \mathcal{J}_5.$$

We now consider formula (2.57). Since $\text{Le} > 1$, it follows that $\text{Re}(k_4) + 1/2 < 0$. Moreover, we observe that the inequality $\text{Re}(k_3) + 1/2 \leq 0$ is satisfied if and only if $\lambda \in \mathcal{P}$. Indeed, fix any $\lambda \in \overset{\circ}{\mathcal{P}}$, the interior of \mathcal{P} , so that $\text{Re}(k_3) + 1/2 < 0$, and take

$$f_1(\xi) = \begin{cases} e^{-\frac{1}{2}\xi}, & \xi < 0, \\ 0, & \xi \geq 0, \end{cases} \quad f_2 \equiv 0 \text{ in } \mathbb{R}.$$

In such a case, the more general solution, $\mathbf{u} \in \mathcal{W}$, to the equation $\lambda \mathbf{u} - \mathcal{L}\mathbf{u} = \mathbf{f}$ is given by $u(\xi) = c_6 e^{k_2\xi}$ and $v(\xi) = c_8 e^{k_6\xi}$ for $\xi \geq 0$, whereas $v \equiv 0$ in $(-\infty, 0)$ and $u(\xi) = c_1 e^{k_1\xi} + 2H_{1,\lambda}^{-2}(2e^{-\frac{1}{2}\xi} - e^{k_1\xi})$ for $\xi < 0$. Note that $k_1 \neq k_3$ for $\lambda \in \overset{\circ}{\mathcal{P}}$. Imposing the boundary conditions, we deduce that $c_6 = c_8 = 0$, $c_1 = -2H_{1,\lambda}^{-2}$ and $k_1 c_1 = 2H_{1,\lambda}^{-2} k_2$, which is clearly a contradiction. We conclude that the domain $\overset{\circ}{\mathcal{P}}$ and, consequently, its closure belong to the continuous spectrum of L . Summarizing, property (1) in the statement of the theorem is established.

Step 2. Here, we consider the equation $\lambda \mathbf{u} - \mathcal{L}\mathbf{u} = \mathbf{f}$ for $\mathbf{f} \in \mathcal{W}$ and values of λ which are not in $(-\infty, -1/4] \cup \mathcal{P}$. For such λ 's and $j = 1, 2$ it holds that

$$\text{Re}(k_{2j-1}) + \frac{1}{2} > 0, \quad \text{Re}(k_{2j}) + \frac{1}{2} < 0, \quad \text{Re}(k_5) + \frac{\text{Le}}{2} > 0, \quad \text{Re}(k_6) + \frac{\text{Le}}{2} < 0. \quad (2.28)$$

We first assume that $k_1 \neq k_3$. Imposing that the function \mathbf{u} defined by (2.58)-(2.57) belongs to \mathcal{W} , we can uniquely determine the constants c_2, c_4, c_5 and c_7 and we get

$$\begin{aligned} u(\xi) = & c_1 e^{k_1\xi} + \frac{e^{k_1\xi}}{H_{1,\lambda}} \int_{\xi}^0 f_1(s) e^{-k_1s} ds + \frac{e^{k_2\xi}}{H_{1,\lambda}} \int_{-\infty}^{\xi} f_1(s) e^{-k_2s} ds \\ & + \frac{A}{H_{1,\lambda}} \left\{ \left(\frac{e^{k_3\xi}}{k_3 - k_2} - \frac{e^{k_3\xi} - e^{k_1\xi}}{k_3 - k_1} \right) c_3 + \frac{\text{Le}}{H_{2,\lambda}} \left[\left(\frac{e^{k_1\xi} - e^{k_3\xi}}{k_3 - k_1} - \frac{e^{k_3\xi}}{k_3 - k_2} \right) \int_{\xi}^0 f_2(s) e^{-k_3s} ds \right. \right. \\ & + \frac{e^{k_1\xi}}{k_3 - k_1} \int_{\xi}^0 f_2(s) e^{-k_1s} ds + \left. \left(\frac{e^{k_1\xi} - e^{k_4\xi}}{k_4 - k_1} + \frac{e^{k_4\xi}}{k_4 - k_2} \right) \int_{-\infty}^{\xi} f_2(s) e^{-k_4s} ds \right. \\ & \left. \left. + \frac{e^{k_1\xi}}{k_4 - k_1} \int_{\xi}^0 f_2(s) (e^{-k_4s} - e^{-k_1s}) ds + \frac{(k_4 - k_3) e^{k_2\xi}}{(k_3 - k_2)(k_4 - k_2)} \int_{-\infty}^{\xi} f_2(s) e^{-k_2s} ds \right] \right\}, \end{aligned} \quad (2.29)$$

$$v(\xi) = \left(c_3 + \frac{\text{Le}}{H_{2,\lambda}} \int_{\xi}^0 f_2(s) e^{-k_3s} ds \right) e^{k_3\xi} + \frac{\text{Le} e^{k_4\xi}}{H_{2,\lambda}} \int_{-\infty}^{\xi} f_2(s) e^{-k_4s} ds, \quad (2.30)$$

2. Stability analysis and Hopf bifurcation in a combustion model

for $\xi < 0$. Note that $k_2 - k_3 \neq 0$ (see Appendix 2.6.1). For $\xi > 0$, we get

$$u(\xi) = \frac{e^{k_1\xi}}{H_{1,\lambda}} \int_{\xi}^{\infty} f_1(s)e^{-k_1s} ds + \left(c_6 + \frac{1}{H_{1,\lambda}} \int_0^{\xi} f_1(s)e^{-k_2s} ds \right) e^{k_2\xi}, \quad (2.31)$$

$$v(\xi) = \frac{\text{Le} e^{k_5\xi}}{H_{3,\lambda}} \int_{\xi}^{\infty} f_2(s)e^{-k_5s} ds + \left(c_8 + \frac{\text{Le}}{H_{3,\lambda}} \int_0^{\xi} f_2(s)e^{-k_6s} ds \right) e^{k_6\xi}. \quad (2.32)$$

Imposing the boundary conditions, we obtain the following linear system for the unknowns c_1, c_3, c_6 and c_8 :

$$\begin{pmatrix} 1 & \frac{A}{(k_3-k_2)H_{1,\lambda}} & -1 & 0 \\ 0 & 1 & 0 & -1 \\ k_1 & \frac{Ak_2}{(k_3-k_2)H_{1,\lambda}} & \frac{1}{\Theta_i-1} - k_2 & 0 \\ 0 & k_3 & \frac{\text{Le}}{1-\Theta_i} & -k_6 \end{pmatrix} \begin{pmatrix} c_1 \\ c_3 \\ c_6 \\ c_8 \end{pmatrix} = \begin{pmatrix} F_1 \\ F_2 \\ F_3 \\ F_4 \end{pmatrix}, \quad (2.33)$$

where

$$\begin{aligned} F_1 &= -\frac{A\text{Le}}{(k_4-k_2)H_{1,\lambda}H_{2,\lambda}}\mathcal{J}_4 - \frac{1}{H_{1,\lambda}}\mathcal{J}_2 + \frac{1}{H_{1,\lambda}}\mathcal{J}_1 - \frac{A\text{Le}(k_4-k_3)}{(k_3-k_2)(k_4-k_2)H_{1,\lambda}H_{2,\lambda}}\mathcal{J}_3; \\ F_2 &= \frac{\text{Le}}{H_{3,\lambda}}\mathcal{J}_5 - \frac{\text{Le}}{H_{2,\lambda}}\mathcal{J}_4; \\ F_3 &= -\frac{A\text{Le}k_2}{(k_4-k_2)H_{1,\lambda}H_{2,\lambda}}\mathcal{J}_4 - \frac{k_2}{H_{1,\lambda}}\mathcal{J}_2 + \frac{1}{H_{1,\lambda}}\left(k_1 + \frac{1}{1-\Theta_i}\right)\mathcal{J}_1 + \frac{A\text{Le}k_2}{(k_3-k_2)(k_4-k_2)H_{1,\lambda}}\mathcal{J}_3; \\ F_4 &= \frac{\text{Le}k_5}{H_{3,\lambda}}\mathcal{J}_5 - \frac{\text{Le}k_4}{H_{2,\lambda}}\mathcal{J}_4 - \frac{\text{Le}}{(1-\Theta_i)H_{4,\lambda}}\mathcal{J}_1. \end{aligned}$$

This system is uniquely solvable if and only if $\bar{D}(\lambda; \Theta_i, \text{Le}) = [\text{Le}(k_2 - k_3)]^{-1}D(\lambda; \Theta_i, \text{Le})$, the determinant of the matrix in left-hand side of (2.33), does not vanish, where $D(\lambda; \Theta_i, \text{Le})$ is defined in (2.26). Hence, the solutions to the equation $D(\lambda; \Theta_i, \text{Le}) = 0$ are elements of the point spectrum of L . Property (3) is proved. On the other hand, as it is easily seen, if $\lambda \notin (-\infty, -1/4] \cup \mathcal{P}$ is not a root of the dispersion relation, then it is easy to check that the function \mathbf{u} given by (2.29)-(2.33) belongs to $D(L)$, so that λ is an element of the resolvent set of operator L .

Finally, we consider the case when $k_3 = k_1$, which gives $\lambda = \lambda_{\pm} := -\frac{A\text{Le}}{\text{Le}-1} \pm \frac{i\sqrt{A\text{Le}(\text{Le}-1)}}{\text{Le}-1}$ (see Appendices 2.6.1 and 2.6.2). It is easy to check that this pair of conjugate complex numbers does not belong to \mathcal{P} . It thus follows that u for $\xi \geq 0$ and v for $\xi \in \mathbb{R}$ are still given

by (2.30), (2.31) and (2.32). On the other hand, for $\xi < 0$, u is given by

$$\begin{aligned}
 u(\xi) = & c_1 e^{k_1 \xi} - \frac{Ac_3}{H_{1,\lambda}} \xi e^{k_1 \xi} + \frac{e^{k_1 \xi}}{H_{1,\lambda}} \int_{\xi}^0 f_1(s) e^{-k_1 s} ds + \frac{e^{k_2 \xi}}{H_{1,\lambda}} \int_{-\infty}^{\xi} f_1(s) e^{-k_2 s} ds \\
 & + \frac{A \text{Le} e^{k_1 \xi}}{H_{1,\lambda} H_{2,\lambda}} \int_{\xi}^0 (s - \xi) f_2(s) ds - \frac{A \text{Le} e^{k_1 \xi}}{H_{1,\lambda} H_{2,\lambda}^2} \int_{-\infty}^0 f_2(s) e^{-k_4 s} ds \\
 & + \frac{A \text{Le} e^{k_1 \xi}}{H_{1,\lambda} H_{2,\lambda}^2} \int_{\xi}^0 f_2(s) e^{-k_1 s} ds + \frac{A \text{Le} e^{k_4 \xi}}{H_{1,\lambda} H_{2,\lambda}^2} \int_{-\infty}^{\xi} f_2(s) e^{-k_4 s} ds \\
 & + \frac{A}{H_{1,\lambda}} \left\{ \frac{e^{k_1 \xi}}{k_1 - k_2} c_3 + \frac{\text{Le}}{H_{2,\lambda}} \left[\frac{e^{k_4 \xi}}{k_4 - k_2} \int_{-\infty}^{\xi} f_2(s) e^{-k_4 s} ds - \frac{e^{k_1 \xi}}{k_1 - k_2} \int_{\xi}^0 f_2(s) e^{-k_1 s} ds \right. \right. \\
 & \left. \left. + \frac{(k_4 - k_1) e^{k_2 \xi}}{(k_1 - k_2)(k_4 - k_2)} \int_{-\infty}^{\xi} f_2(s) e^{-k_2 s} ds \right] \right\}.
 \end{aligned}$$

Notice that $\sup_{\xi < 0} e^{\frac{1}{2}\xi} |u(\xi)| < \infty$; therefore, \mathbf{u} belongs to \mathcal{W} . Imposing the boundary conditions, we get a linear system for the unknowns (c_1, c_3, c_6, c_8) , whose matrix is the same as in (2.33). Since the determinant is not zero when $\lambda = \lambda_{\pm}$ (see Appendix 2.6.2) and the first- and second-order derivatives of \mathbf{u} belong to \mathcal{W} , we conclude that λ_{\pm} are in the resolvent set of operator L .

Step 3. Now, we proceed to show that 0 is an isolated simple eigenvalue of the operator L . In view of the previous steps, in a neighborhood of $\lambda = 0$ the solution $\mathbf{u} = R(\lambda, L)\mathbf{f}$ of the equation $\lambda \mathbf{u} - L\mathbf{u} = \mathbf{f}$ is given by (2.29)-(2.32) for any $\mathbf{f} \in \mathcal{W}$, where

$$\begin{aligned}
 c_1 = & \frac{\text{Le}(k_2 - k_3)}{D(\lambda; \Theta_i, \text{Le})} \left\{ \left[\frac{(k_6 - k_3)(1 - \Theta_i)}{\text{Le}} - \frac{A}{(k_3 - k_2)H_{1,\lambda}} \right] \mathcal{J}_1 + \frac{k_6 - k_3}{\text{Le}H_{1,\lambda}} \mathcal{J}_2 - \frac{A(k_6 - k_3)}{(k_3 - k_2)(k_4 - k_2)H_{1,\lambda}} \mathcal{J}_3 \right. \\
 & \left. + \frac{A}{H_{1,\lambda}H_{2,\lambda}} \left(\frac{k_6 - k_3}{k_4 - k_2} - \frac{k_6 - k_4}{k_3 - k_2} \right) \mathcal{J}_4 - \frac{A}{(k_3 - k_2)H_{1,\lambda}} \mathcal{J}_5 \right\}, \\
 c_3 = & \frac{\text{Le}(k_2 - k_3)}{D(\lambda; \Theta_i, \text{Le})} \left\{ \mathcal{J}_1 + \mathcal{J}_2 - \frac{A \text{Le}}{(k_4 - k_2)(k_3 - k_2)} \mathcal{J}_3 \right. \\
 & \left. + \frac{1}{H_{2,\lambda}} \left[(k_6 - k_4) [1 - H_{1,\lambda}(1 - \Theta_i)] + \frac{A \text{Le}}{k_4 - k_2} \right] \mathcal{J}_4 + [1 - H_{1,\lambda}(1 - \Theta_i)] \mathcal{J}_5 \right\}, \\
 c_6 = & \frac{\text{Le}(k_2 - k_3)}{D(\lambda; \Theta_i, \text{Le})} \left\{ \frac{1}{H_{1,\lambda}} \left(\frac{A}{k_3 - k_2} + \frac{k_6 - k_3}{\text{Le}} \right) \mathcal{J}_1 + \frac{(k_6 - k_3)(1 - \Theta_i)}{\text{Le}} \mathcal{J}_2 - \frac{A(k_6 - k_3)(1 - \Theta_i)}{(k_3 - k_2)(k_4 - k_2)} \mathcal{J}_3 \right. \\
 & \left. + \frac{A(1 - \Theta_i)}{H_{2,\lambda}} \left(\frac{k_6 - k_3}{k_4 - k_2} - \frac{k_6 - k_4}{k_3 - k_2} \right) \mathcal{J}_4 - \frac{A(1 - \Theta_i)}{k_3 - k_2} \mathcal{J}_5 \right\}, \\
 c_8 = & \frac{\text{Le}(k_2 - k_3)}{D(\lambda; \Theta_i, \text{Le})} \left\{ \mathcal{J}_1 + \mathcal{J}_2 - \frac{A \text{Le}}{(k_3 - k_2)(k_4 - k_2)} \mathcal{J}_3 + \left[1 - H_{1,\lambda}(1 - \Theta_i) + \frac{A \text{Le}}{(k_3 - k_2)(k_4 - k_2)} \right] \mathcal{J}_4 \right. \\
 & \left. + \left[\frac{A \text{Le}}{(k_3 - k_2)H_{3,\lambda}} + [1 - H_{1,\lambda}(1 - \Theta_i)] \left(1 + \frac{k_6 - k_3}{H_{3,\lambda}} \right) \right] \mathcal{J}_5 \right\}.
 \end{aligned}$$

2. Stability analysis and Hopf bifurcation in a combustion model

As it is immediately seen, the function $D(\cdot; \Theta_i, \text{Le})$ is analytic in a neighborhood of $\lambda = 0$, which is simple zero of such a function, and the other functions appearing in (2.29)-(2.32) are holomorphic in a neighborhood of $\lambda = 0$. Hence, we conclude that zero is a simple pole of the resolvent operator $R(\lambda, L)$. Since $\frac{d\mathbf{U}}{d\xi}$ belongs to the kernel of L (see Remark 2.2) and the matrix in (2.33) has rank three at $\lambda = 0$, this function generates the kernel, so that the geometric multiplicity of the eigenvalue $\lambda = 0$ is one. This is enough to conclude that $\lambda = 0$ is a simple eigenvalue of L . Property (2) is established and the spectrum of L is completely characterized.

Step 4. In order to prove that L is sectorial, it is sufficient to show that there exist two positive constants C and M such that

$$\|R(\lambda, L)\|_{L(\mathcal{W})} \leq C|\lambda|^{-1}, \quad \text{Re } \lambda \geq M. \quad (2.34)$$

Without loss of generality, we can assume that $k_{1,\lambda} \neq k_{3,\lambda}$ and the conditions in (2.28) are all satisfied if $\text{Re } \lambda \geq M$. Throughout this step, C_j denotes a positive constant, independent of λ and $\mathbf{f} \in \mathcal{W}$.

We begin by estimating the terms $H_{j,\lambda}$ ($j = 1, 2, 3$). As it is easily seen,

$$|H_{2,\lambda}| \geq \text{Re}(H_{2,\lambda}) = \sqrt{\frac{|\text{Le}^2 + 4\text{Le}(A + \lambda)| + \text{Le}^2 + 4\text{Le}(A + \text{Re } \lambda)}{2}} \geq \sqrt{2\text{Le}|\lambda|} \quad (2.35)$$

for any $\lambda \in \mathbb{C}$ with positive real part. Since $H_{1,\lambda}$ and $H_{3,\lambda}$ can be obtained from $H_{2,\lambda}$, by taking, $(\text{Le}, A) = (1, 0)$ and $(\text{Le}, A) = (\text{Le}, 0)$ respectively, we also deduce that

$$|H_{1,\lambda}| \geq \text{Re}(H_{1,\lambda}) \geq \sqrt{2|\lambda|}, \quad |H_{3,\lambda}| \geq \text{Re}(H_{3,\lambda}) \geq \sqrt{2\text{Le}|\lambda|} \quad (2.36)$$

for the same values of λ . Thanks to (2.35) and (2.36), we can easily estimate the terms \mathcal{J}_j ($j = 1, \dots, 5$). Indeed, since $\text{Re}(k_1) + 1/2 > 0$, we obtain

$$|\mathcal{J}_1| = \left| \int_0^\infty f_1(s) e^{-k_1 s} ds \right| \leq \sup_{\xi > 0} e^{\frac{1}{2}\xi} |f_1(\xi)| \int_0^\infty e^{-\frac{1}{2}\text{Re}(H_{1,\lambda})s} ds \leq C_1 |\lambda|^{-\frac{1}{2}} \|\mathbf{f}\|_{\mathcal{W}}.$$

The other terms \mathcal{J}_j can be treated likewise and we get $\sum_{j=2}^5 |\mathcal{J}_j| \leq C_2 |\lambda|^{-\frac{1}{2}} \|\mathbf{f}\|_{\mathcal{W}}$ for every $\mathbf{f} \in \mathcal{W}$ and $\lambda \in \mathbb{C}$ with positive real part.

Next, we turn to the function $D(\cdot; \Theta_i, \text{Le})$. We observe that

$$|D(\lambda; \Theta_i, \text{Le})| \geq [(1 - \Theta_i) \sqrt{|1 + 4\lambda|} - 1] |k_{6,\lambda} - k_{3,\lambda}| |k_{3,\lambda} - k_{2,\lambda}| - A\text{Le}$$

for any $\lambda \in \mathbb{C}$. Taking (2.35) and (2.36) into account, we can show that

$$C_3\sqrt{|\lambda|} \leq |k_{3,\lambda} - k_{2,\lambda}| + |k_{3,\lambda} - k_{6,\lambda}| \leq C_4\sqrt{|\lambda|} \quad (2.37)$$

for $\lambda \in \mathbb{C}$ with sufficiently large positive real part. Hence, for such values of λ 's we can continue the previous inequality and get

$$|D(\lambda; \Theta_i, \text{Le})| \geq C_5|\lambda|^{\frac{3}{2}}. \quad (2.38)$$

Similarly, $|k_{6,\lambda} - k_{4,\lambda}| \leq C_6\sqrt{|\lambda|}$ for any λ with positive real part and

$$|k_{4,\lambda} - k_{2,\lambda}| \geq \frac{1}{2}|H_{2,\lambda}| - \frac{1}{2}|H_{1,\lambda}| - \frac{\text{Le} - 1}{2} \geq \sqrt{\frac{\text{Le}|\lambda|}{2}} - \sqrt{\frac{|\lambda|}{2}} - \frac{\text{Le} - 1}{2} \geq C_7\sqrt{|\lambda|}, \quad (2.39)$$

if $\text{Re } \lambda$ is sufficiently large. From (2.35)-(2.39) we infer that $|c_1| + |c_3| + |c_6| + |c_8| \leq C_8|\lambda|^{-1}$ for any $\lambda \in \mathbb{C}$ with $\text{Re}(\lambda) \geq M$ and a suitable positive constant M . Further, observing that

$$|k_{3,\lambda} - k_{1,\lambda}| + |k_{4,\lambda} - k_{1,\lambda}| \geq C_9\sqrt{|\lambda|}, \quad |k_{4,\lambda} - k_{3,\lambda}| \leq C_{10}\sqrt{|\lambda|},$$

we are now able to estimate the functions u and v in (2.29)-(2.32) and show that (2.34) holds true. The proof is complete. \square

Remark 2.4. It is worth pointing out that, as $\text{Le} \rightarrow \infty$, the set \mathcal{P} degenerates into a vertical line $\text{Re } \lambda = -\Theta_i(1 - \Theta_i)^{-1} - 1/2$. In the limit case, the system is partly parabolic and the semigroup is not analytic, see, e.g., [80, Section 1, p. 2435].

2.3 The fully nonlinear problem

Our goal in this section is to get rid of the eigenvalue 0 and then derive a new fully nonlinear problem. We recall that the eigenvalue 0 is related to the translation invariance of the traveling wave. In a first step, we use here a method similar to that of [45] or [119, p. 358].

2.3.1 Ansatz revisited: elimination of the eigenvalue 0

It is convenient to write System (2.14)-(2.15) with notation $\mathbf{u} = (u_1, u_2)$, $\mathbf{U} = (\Theta^0, \Phi^0)$, see Section 2.2.1, in an abstract form:

$$\dot{\mathbf{u}} = L\mathbf{u} + \dot{s}\mathbf{U}' + \dot{s}\mathbf{u}'. \quad (2.40)$$

Note that, in view of (2.16), $\mathbf{u}(\tau, \cdot)$ belongs to $D(L)$ for each τ . Since 0 is an isolated simple eigenvalue of L , we can introduce the spectral projection P onto the kernel of L , defined by

2. Stability analysis and Hopf bifurcation in a combustion model

$P\mathbf{f} = \langle \mathbf{f}, \mathbf{e}^* \rangle \mathbf{U}'$ for every $\mathbf{f} \in \mathcal{W}$ and a unique $\mathbf{e}^* \in \mathcal{W}^*$, the dual space of \mathcal{W} , such that $\langle \mathbf{U}', \mathbf{e}^* \rangle = 1$. For further use, we recall that P commutes with L on $D(L)$. We are going to apply the projections P and $Q = I - P$ to System (2.40) to remove the eigenvalue 0.

Ansatz 2 We split \mathbf{u} into $\mathbf{u}(\tau, \cdot) = P\mathbf{u}(\tau, \cdot) + Q\mathbf{u}(\tau, \cdot) = p(\tau)\mathbf{U}' + \mathbf{w}(\tau, \cdot)$, i.e.,

$$\begin{aligned} u_1(\tau, \xi) &= p(\tau) \frac{d\Theta^0}{d\xi}(\xi) + w_1(\tau, \xi), \\ u_2(\tau, \xi) &= p(\tau) \frac{d\Phi^0}{d\xi}(\xi) + w_2(\tau, \xi), \end{aligned} \quad (2.41)$$

where $p(\tau) = \langle \mathbf{u}(\tau), \mathbf{e}^* \rangle$ and $\mathbf{w} = (w_1, w_2)$. Clearly, $\mathbf{w}(\tau, \cdot) \in Q(D(L))$ for each τ . It follows from (2.40) that

$$\dot{p} = \dot{s} + \dot{s}\langle \mathbf{u}', \mathbf{e}^* \rangle, \quad \dot{\mathbf{w}} = L\mathbf{w} + \dot{s}Q\mathbf{u}', \quad (2.42)$$

a Lyapunov-Schmidt-like reduction of the problem. We point out that the above procedure generates a new ansatz slightly different from ansatz 1 (see (2.17)) that helps us determine the functional framework.

Thanks to new ansatz 2, we are going to derive an equation for \mathbf{w} in the space \mathcal{W} . Now, the spectrum of the part of L in $Q(\mathcal{W})$ does not contain the eigenvalue 0.

2.3.2 Derivation of the fully nonlinear equation

To get a self-contained equation for \mathbf{w} , we need to eliminate \dot{s} from the right-hand side of the second equation in (2.42). For this purpose, we begin by evaluating the first component of (2.42) at $\xi = 0^+$ to get

$$\begin{aligned} \frac{\partial w_1}{\partial \tau}(\cdot, 0^+) &= (L\mathbf{w})_1(\cdot, 0^+) + \dot{s}(Q\mathbf{u}')_1(\cdot, 0^+) \\ &= (L\mathbf{w})_1(\cdot, 0^+) + \dot{s} \frac{\partial u_1}{\partial \xi}(\cdot, 0^+) + \dot{s}\langle \mathbf{u}', \mathbf{e}^* \rangle \Theta_i. \end{aligned} \quad (2.43)$$

Next, we observe that the function w_1 is continuous (but not differentiable) at $\xi = 0$, since both \mathbf{u} and \mathbf{U}' are continuous at $\xi = 0$. Therefore, evaluating (2.41) at $\xi = 0$ and recalling that $u_1(\tau, 0) = 0$ (see (2.16)), we infer that $w_1(\tau, 0) = \Theta_i p(\tau)$. Differentiating this formula yields

$$\frac{\partial w_1}{\partial \tau}(\cdot, 0) = \dot{p}\Theta_i = \dot{s}\Theta_i + \dot{s}\langle \mathbf{u}', \mathbf{e}^* \rangle \Theta_i, \quad (2.44)$$

From (2.43) and (2.44), it follows that

$$\dot{s}\Theta_i = (L\mathbf{w})_1(\cdot, 0^+) + \dot{s}\frac{\partial u_1}{\partial \xi}(\cdot, 0^+). \quad (2.45)$$

To get rid of the spatial derivatives of u_1 from the right-hand side of (2.45), we use (2.41) to write

$$\frac{\partial u_1}{\partial \xi}(\cdot, 0^+) = p\frac{d^2\Theta^0}{d\xi^2}(0^+) + w'_1(\cdot, 0^+) = w_1(\cdot, 0) + w'_1(\cdot, 0^+). \quad (2.46)$$

Plugging (2.46) into (2.45), we finally obtain the formula

$$\dot{s} = \frac{(L\mathbf{w})_1(\cdot, 0^+)}{\Theta_i - w_1(\cdot, 0) - w'_1(\cdot, 0^+)}, \quad (2.47)$$

which can be regarded as a underlying *second-order Stefan condition*, see [43]. Hence, replacing it in (2.42), we get

$$\begin{aligned} \frac{\partial \mathbf{w}}{\partial \tau} &= L\mathbf{w} + \frac{(L\mathbf{w})_1(\cdot, 0^+)}{\Theta_i - w_1(\cdot, 0) - w'_1(\cdot, 0^+)} Q\mathbf{u}' \\ &= L\mathbf{w} + \frac{(L\mathbf{w})_1(\cdot, 0^+)}{\Theta_i - w_1(\cdot, 0) - w'_1(\cdot, 0^+)} Q\left(\frac{w_1(\cdot, 0)}{\Theta_i}\mathbf{U}'' + \mathbf{w}'\right), \end{aligned}$$

which is a fully nonlinear parabolic equation in the space \mathbf{W} written in a more abstract form:

$$\frac{\partial \mathbf{w}}{\partial \tau} = L\mathbf{w} + F(\mathbf{w}), \quad \mathbf{w} \in Q(D(L)). \quad (2.48)$$

and is going to be the subject of our attention. Note that Equation (2.48) is fully nonlinear since the function F depends on \mathbf{w} also through the limit at 0^+ of $L\mathbf{w}$. Moreover, the operator L is sectorial in $Q(\mathbf{W})$. Hence, we can take advantage of the theory of analytic semigroups to solve Equation (2.48). We refer the reader to [119, Chapter 4] for further details.

2.4 Stability of the traveling wave solution

This section is devoted to the analysis of the stability of the traveling wave solution \mathbf{U} . Here, stability refers to orbital stability with asymptotic phase s_∞ . From now on, we focus on the asymptotic situation where the Lewis number, Le , is large and, in this respect, we use the notation $\varepsilon = 1/Le$ to stand for a small perturbation parameter. Simultaneously, we assume that Θ_i is close to the burning temperature normalized at unity, which is physically relevant (see [35, Section 3.2, Fig. 5]). More specifically, we restrict Θ_i to the domain $\frac{2}{3} < \Theta_i < 1$.

In what follows, we introduce $m := \Theta_i/(1 - \Theta_i)$ as the *bifurcation parameter* which runs

2. Stability analysis and Hopf bifurcation in a combustion model

in the interval $(2, \infty)$, due to the choice of Θ_i . With the above notation, $A = m + \varepsilon m^2$ and the *dispersion relation* $D(\lambda; \Theta_i, \text{Le})$ (see (2.26)) in Section 2 reads:

$$D_\varepsilon(\lambda; m) = -\frac{1}{4} \left(\sqrt{1 + 4\varepsilon(m + \varepsilon m^2 + \lambda)} + \sqrt{1 + 4\varepsilon\lambda} \right) \\ \times \left(\frac{1}{\varepsilon} [\sqrt{1 + 4\varepsilon(m + \varepsilon m^2 + \lambda)} - 1] + 1 + \sqrt{1 + 4\varepsilon\lambda} \right) \left(1 - \frac{\sqrt{1 + 4\varepsilon\lambda}}{1 + m} \right) + m + \varepsilon m^2. \quad (2.49)$$

This section is split into two parts. First, we study the stability of the null solution of the fully nonlinear equation (2.48). Second, we turn our attention to the stability of the traveling wave.

2.4.1 Stability of the null solution of (2.48)

To begin with, we recall that the spectrum of the part of L in $\mathcal{W}_Q := Q(\mathcal{W})$ is the set

$$(-\infty, -\frac{1}{4}] \cup \mathcal{P} \cup \{\lambda \in \mathbb{C} \setminus \{0\} : D_\varepsilon(\lambda; m) = 0\}.$$

As we will show, the roots of the dispersion relation $D_\varepsilon(\cdot; m)$ are finitely many. As a consequence, there is a gap between the spectrum of this operator and the imaginary axis (at least for ε small enough). In view of the principle of linearized stability, the main step in the analysis of the stability of the null solution of Equation (2.48) is a deep insight in the solutions of the dispersion relation. More precisely, we need to determine when they are all contained in the left halfplane and when some of them lie in the right halfplane.

The limit critical value $m^c = 6$ will play an important role in the analysis hereafter.

Theorem 2.5. *The following properties are satisfied.*

- (i) *Let $m \in (2, m^c)$ be fixed. Then, there exists $\varepsilon_0 = \varepsilon_0(m) > 0$ such that, for $\varepsilon \in (0, \varepsilon_0)$, the null solution of the fully nonlinear problem (2.48) is stable with respect to perturbations belonging to $Q(D(L))$.*
- (ii) *Let $m > m^c$ be fixed. Then, there exists $\varepsilon_1 = \varepsilon_1(m)$ small enough such that, for $\varepsilon \in (0, \varepsilon_1)$, the null solution of (2.48) is unstable with respect to perturbations belonging to $Q(D(L))$.*

Proof. To begin with, we observe that the functions $D_\varepsilon(\cdot, m)$ are holomorphic in $\mathbb{C} \setminus (-\infty, -1/4]$

and therein they locally converge to the *limit dispersion relation* $D_0(\cdot, m)$ defined by

$$\begin{aligned} D_0(\lambda; m) &= -\frac{1}{2}[2(m + \lambda) + 1 + \sqrt{1 + 4\lambda}] \left(1 - \frac{\sqrt{1 + 4\lambda}}{1 + m}\right) + m \\ &= \frac{\sqrt{1 + 4\lambda} - 1}{4(1 + m)} [4\lambda - (m - 2)\sqrt{1 + 4\lambda} + m + 2], \end{aligned}$$

as $\varepsilon \rightarrow 0^+$. The solutions of the equation $D_0(\lambda; m) = 0$ are $\lambda = 0$, for all m , and the roots of the second-order polynomial $4\lambda^2 + (6m - m^2)\lambda + 2m$, whose real part is not less than $-(m + 2)/4$. This polynomial admits conjugate solutions $\lambda_{1,2} = a(m) \pm ib(m)$, where $a(m) = \frac{1}{8}(m^2 - 6m)$ and $b(m) = \frac{1}{8}(m - 2)\sqrt{|8m - m^2|}$, if $m \in (2, 8)$ and real solutions $\lambda_{1,2} = a(m) \pm b(m)$ otherwise. The coefficient $a(m)$ is negative whenever $2 < m < 6$ and positive for $m > 6$. It can be easily checked that $\operatorname{Re}(\lambda_{1,2}) \geq -(m + 2)/4$ for each $m \in (2, \infty)$, so that $\lambda_{1,2}$ solve the equation $D_0(\lambda; m) = 0$. In particular, there are two conjugate purely imaginary roots $\lambda_{1,2} = \pm\sqrt{3}i$ at $m = 6$.

We can now prove properties (i) and (ii).

(i) Fix $\rho > 0$ such that the closure of the disks of center $\lambda_{1,2}$ and radius ρ is contained in $\{\operatorname{Re} z < 0\} \setminus (-\infty, -\frac{1}{4}]$. Hurwitz Theorem (see, e.g., [55, Chapter 7, Section 2]) and the above results show that there exists $\varepsilon_0 > 0$ such that, for $\varepsilon \in (0, \varepsilon_0)$, $D_\varepsilon(\lambda; m)$ admits exactly two conjugate complex roots $\lambda_{1,2}(\varepsilon)$ in the disk $|\lambda - \lambda_i| < \rho$ and $\lambda_i(\varepsilon)$ converges to λ_i , as $\varepsilon \rightarrow 0$, for $i = 1, 2$. Therefore, all the elements of the spectrum of the part of operator L in \mathcal{W}_Q have negative real parts, which implies that the operator norm of the restriction to \mathcal{W}_Q of the analytic semigroup $e^{\tau L}$ generated by L , decays to zero with exponential rate as $t \rightarrow \infty$. Now, the nonlinear stability follows from applying a standard machinery: the solution of Equation (2.48), with initial datum \mathbf{w}_0 in a small (enough) ball of $Q(D(L))$ centered at zero, is given by the variation-of-constants-formula

$$\mathbf{w}(\tau, \cdot) = e^{\tau L} \mathbf{w}_0 + \int_0^\tau e^{(\tau-s)L} F(\mathbf{w}(s, \cdot)) ds, \quad \tau > 0.$$

Applying the Banach fixed point theorem in the space

$$\mathcal{X}_\omega^\alpha = \left\{ \mathbf{w} \in C([0, \infty); \mathcal{W}_Q) : \sup_{\sigma \in (0, 1)} \sigma^\alpha \|\mathbf{w}\|_{C^\alpha([\sigma, 1]; D(L))} < \infty : \tau \mapsto e^{\omega\tau} \mathbf{w}(\tau, \cdot) \in C^\alpha([1, \infty); D(L)) \right\},$$

endowed with the natural norm, where α is fixed in $(0, 1)$ and ω is any positive number less than the real part of $\lambda_1(\varepsilon)$, allows us to prove the existence and uniqueness of a solution \mathbf{w} of (2.48), defined in $(0, \infty)$ such that $\|\mathbf{w}(\tau, \cdot)\|_{\mathcal{W}} + \|L\mathbf{w}(\tau, \cdot)\|_{\mathcal{W}} \leq C e^{-\omega\tau} \|\mathbf{w}_0\|_{D(L)}$ for $\tau \in (0, \infty)$ and some positive constant C , which yields the claim. For further details see [119, Chapter 9].

(ii) For $m > m^c$, we use again Hurwitz Theorem to show that there exists $\varepsilon_1 = \varepsilon_1(m) > 0$

2. Stability analysis and Hopf bifurcation in a combustion model

such that the equation $D_\varepsilon(\lambda, m) = 0$ admits a solution with positive real part if $\varepsilon \in (0, \varepsilon_1)$. More precisely, it admits a couple of conjugate complex roots with positive real parts, if $m < 8$, a positive root, if $m = 8$, and two real solutions if $m > 8$. For these values of ε , the restriction of the semigroup $e^{\tau L}$ to \mathcal{W}_Q exhibits an exponential dichotomy, i.e., there exists a spectral projection P_+ which allows to split $\mathcal{W}_Q = P_+(\mathcal{W}_Q) \oplus (I - P_+)(\mathcal{W}_Q)$. The semigroup $e^{\tau L}$ decays to zero with exponential rate when restricted to $(I - P_+)(\mathcal{W}_Q)$, whereas the restriction of $e^{\tau L}$ to $P_+(\mathcal{W}_Q)$ extends to a group which decays to zero with exponential rate as $\tau \rightarrow -\infty$. Again with a fixed point technique, we can prove the existence of a nontrivial backward solution \mathbf{z} of the nonlinear equation (2.48), defined in $(-\infty, 0)$ such that $\|\mathbf{z}(\tau, \cdot)\|_{\mathcal{W}} + \|L\mathbf{z}(\tau, \cdot)\|_{\mathcal{W}} \leq C_\omega e^{\omega\tau}$ for $\tau \in (-\infty, 0)$ and any ω positive and smaller than the minimum of the positive real parts of the roots of the dispersion relation. The sequence (\mathbf{z}_n) defined by $\mathbf{z}_n = \mathbf{z}(-n, \cdot)$ vanishes in $D(L)$ as $n \rightarrow +\infty$ and the solution \mathbf{w}_n to (2.48) subject to the initial condition $\mathbf{w}_n(0, \cdot) = \mathbf{z}_n$ exists at least in the time domain $[0, n]$, where it coincides with the function $\mathbf{z}(\cdot - n, \cdot)$. Thus, the norm of $\|\mathbf{w}_n\|_{C([0, n]; \mathcal{W}_Q)}$ is positive and far way from zero, uniformly with respect to $n \in \mathbb{N}$, whence the instability of the trivial solution of (2.48) follows. Again, we refer the reader to [119, Chapter 9] for further results. \square

2.4.2 Stability of the traveling wave

We can now rewrite the results in Theorem 2.5 in terms of problem (2.11)-(2.13).

Theorem 2.6. *The following properties are satisfied.*

- (i) *For $m \in (2, m^c)$ fixed, there exists $\varepsilon_0 = \varepsilon_0(m) > 0$ such that, for $\varepsilon \in (0, \varepsilon_0)$, the traveling wave solution \mathbf{U} is orbitally stable with asymptotic phase s_∞ (see (2.50)), with respect to perturbations belonging to the weighted space $D(L)$.*
- (ii) *For $m > m^c$ fixed, there exists $\varepsilon_1 = \varepsilon_1(m)$ small enough such that, for $\varepsilon \in (0, \varepsilon_1)$, the traveling wave \mathbf{U} is unstable. with respect to perturbations belonging to the weighted space $D(L)$.*

Proof. (i) Let us fix $\mathbf{w}_0 \in Q(D(L))$ with $\|\mathbf{w}_0\|_{D(L)}$ small enough, so that Theorem 2.5(i) can be applied. Denote by \mathbf{w} the classical solution to Equation (2.48) which satisfies the initial condition $\mathbf{w}(0, \cdot) = \mathbf{w}_0 = (w_{0,1}, w_{0,2})$. Observe that, since $p = \Theta_i^{-1}w_1(\cdot, 0)$ (see Subsection 2.3.1) it follows that the problem (2.40), subject to the initial condition $\mathbf{u}(0, \cdot) = \Theta_i^{-1}w_{0,1}\mathbf{U}' + \mathbf{w}_0$, admits a unique classical solution (\mathbf{u}, s) , where \mathbf{u} decreases to zero as $\tau \rightarrow \infty$, with exponential rate. Moreover, using (2.47) it is immediate to check that $s(\tau)$ converges to

$$s_\infty = \int_0^\infty \frac{(L\mathbf{w})_1(\tau, 0^+)}{\Theta_i - w_1(\tau, 0) - w_1'(\tau, 0^+)} d\tau, \quad (2.50)$$

as $\tau \rightarrow \infty$ (assuming for simplicity that g vanishes at $\tau = 0$). We point out that s_∞ depends on the initial condition.

Coming back to problem (2.11)-(2.13) with initial condition $\mathbf{X}(0) = \mathbf{u}_0 + \mathbf{U}$ and $g(0) = 0$, we easily see that the solution $\mathbf{X} = (\Theta, \Phi)$ is defined by

$$\begin{aligned} \mathbf{X} &= p\mathbf{U}' + \mathbf{w} + \mathbf{U} = \Theta_i^{-1}w_1(\cdot, 0)\mathbf{U}' + \mathbf{w} + \mathbf{U}, \\ g(\tau) &= \tau + \int_0^\tau \frac{(L\mathbf{w})_1(\sigma, 0^+)}{\Theta_i - w_1(\sigma, 0) - w_1'(\sigma, 0^+)} d\sigma, \quad \tau \geq 0. \end{aligned}$$

From this formula and the above result, the claim follows at once.

(ii) The proof is similar to that of property (i) and, hence, it is left to the reader. \square

2.5 Hopf bifurcation

This section is devoted to investigating the dynamics of the perturbation of the traveling wave in a neighborhood, say $(6 - \delta, 6 + \delta)$, of the limit critical value $m^c = 6$ (see Section 2.4). As regards parameter m , the situation is more complicated than in Section 4 when it was fixed. Now, the dispersion relation $D_\varepsilon(\lambda; m)$ can be seen as a sequence of analytic functions parameterized by m . The main difficulty here is that Hurwitz Theorem does not a priori apply, particularly because of the lack of uniformity of $D_\varepsilon(\lambda; m)$ with respect to ε and m . We especially find a proper approach to combining m with ε : we construct in Proposition 2.7 a sequence of critical values $m^c(\varepsilon)$ such that $m^c(0) = m^c$ and apply Hurwitz Theorem to the sequence $D_\varepsilon(\lambda, m^c(\varepsilon))$. This proposition will be crucial for proving the existence of a Hopf bifurcation (see Theorem 2.9).

2.5.1 Local analysis of the dispersion relation

We look for the roots of the *dispersion relation*, see (2.49), in a neighborhood of $m^c = 6$ and of $\lambda = \pm i\sqrt{3}$, for $\varepsilon > 0$ small enough. A natural idea is to turn the dispersion relation into a polynomial by squaring, however the price to pay is double: the polynomial will be of high order without algebraic solution, and spurious roots therefore appear.

For convenience, we rewrite the equation $D_\varepsilon(\lambda; m) = 0$ into a much more useful form. Replacing $\sqrt{1 + 4\varepsilon(m + \varepsilon m^2 + \lambda)} + \sqrt{1 + 4\varepsilon\lambda}$ by $4\varepsilon(m + \varepsilon m^2)(\sqrt{1 + 4\varepsilon(m + \varepsilon m^2 + \lambda)} - \sqrt{1 + 4\varepsilon\lambda})^{-1}$ with some straightforward algebra we obtain the equivalent equation

$$\sqrt{1 + 4\varepsilon\lambda} - \frac{1}{1 + m} \sqrt{1 + 4\varepsilon(m + \varepsilon m^2 + \lambda)} \sqrt{1 + 4\lambda} + \frac{1 + \varepsilon m}{1 + m} \sqrt{1 + 4\lambda} = \varepsilon \frac{1 + 4\lambda}{1 + m} + 1 - \varepsilon. \quad (2.51)$$

2. Stability analysis and Hopf bifurcation in a combustion model

If we denote by ζ the right-hand side of (2.51) and set

$$\begin{aligned}\Sigma_1 &= 1 + 4\varepsilon\lambda + \frac{2 + 6\varepsilon m + 5\varepsilon^2 m^2 + 4\varepsilon\lambda}{(1 + m)^2}(1 + 4\lambda), \\ \Sigma_2 &= \frac{1 + 4\lambda}{(1 + m)^2} \left[(2 + 6\varepsilon m + 5\varepsilon^2 m^2 + 4\varepsilon\lambda)(1 + 4\varepsilon\lambda) + \frac{[1 + 4\varepsilon(m + \varepsilon m^2 + \lambda)](1 + \varepsilon m)^2}{(1 + m)^2}(1 + 4\lambda) \right], \\ \Sigma_3 &= \frac{[1 + 4\varepsilon(m + \varepsilon m^2 + \lambda)](1 + \varepsilon m)^2}{(1 + m)^4}(1 + 4\varepsilon\lambda)(1 + 4\lambda)^2.\end{aligned}$$

Squaring both sides of (2.51) and rearranging terms we get the equation

$$\begin{aligned}\zeta^2 - \Sigma_1 &= \frac{2\sqrt{1 + 4\lambda}}{1 + m} \left\{ \sqrt{1 + 4\varepsilon\lambda}[1 + \varepsilon m - \sqrt{1 + 4\varepsilon(m + \varepsilon m^2 + \lambda)}] \right. \\ &\quad \left. - \frac{1 + \varepsilon m}{1 + m} \sqrt{1 + 4\lambda} \sqrt{1 + 4\varepsilon(m + \varepsilon m^2 + \lambda)} \right\}.\end{aligned}\quad (2.52)$$

Squaring both sides of (2.52) and rearranging terms gives

$$\begin{aligned}(\zeta^2 - \Sigma_1)^2 - 4\Sigma_2 &= \frac{8\sqrt{1 + 4\varepsilon\lambda}(1 + 4\lambda)}{(1 + m)^2} \left[\frac{[1 + 4\varepsilon(m + \varepsilon m^2 + \lambda)](1 + \varepsilon m)}{1 + m} \sqrt{1 + 4\lambda} \right. \\ &\quad - \frac{(1 + \varepsilon m)^2}{1 + m} \sqrt{1 + 4\varepsilon(m + \varepsilon m^2 + \lambda)} \sqrt{1 + 4\lambda} \\ &\quad \left. - (1 + \varepsilon m) \sqrt{1 + 4\varepsilon\lambda} \sqrt{1 + 4\varepsilon(m + \varepsilon m^2 + \lambda)} \right].\end{aligned}\quad (2.53)$$

Finally, squaring both sides of (2.53) and using (2.52), we conclude that $[(\zeta^2 - \Sigma_1)^2 - 4\Sigma_2]^2 - 64\Sigma_3\zeta^2 = 0$ or, equivalently, $P_7(\lambda; m, \varepsilon) = 0$, where $P_7(\cdot; m, \varepsilon)$ is a seventh-order polynomial (see Appendix 2.6.3 for the expression of the coefficients of the polynomial).

Finding the eigenvalues of $P_7(\cdot; m, \varepsilon)$ is quite challenging. The Routh-Hurwitz criterion (see, e.g., [78, Chapter XV]) gives relevant information on the eigenvalues without computing them explicitly, in particular whether the eigenvalues lie in the left halfplane $\text{Re}\lambda < 0$, by computing the Hurwitz determinants Δ_j ($j = 1, \dots, 6$) associated with $P_7(\lambda; m, \varepsilon)$. Unfortunately, our double-squaring method produces spurious eigenvalues which render Routh-Hurwitz criterion inefficient. However, Orlando's formula (see [78, Chapter XV, 7]), a generalization of the well-known property for the sum of the roots of a quadratic equation, establishes a relation between the leading Hurwitz determinant Δ_6 and the sums of all different pairs of roots of $P_7(\lambda; m, \varepsilon)$. In particular, $\Delta_6 = 0$ in the case when either 0 is a double eigenvalue (i.e., 0 is an eigenvalue with algebraic multiplicity two) or two eigenvalues are purely imaginary and conjugate.

The following one is the main result of this subsection.

Proposition 2.7. *There exist $\varepsilon_0 > 0$ and $\delta > 0$, and a unique function $m^c : (0, \varepsilon_0) \rightarrow (6 - \delta, 6 + \delta)$ with $m^c(0) = 6$, such that the polynomial $\tilde{P}_7(\lambda; \varepsilon) := P_7(\lambda; m^c(\varepsilon), \varepsilon)$ has exactly one pair of purely imaginary roots $\pm i\omega(\varepsilon)$, with $\omega(\varepsilon) > 0$. Moreover, $\omega(\varepsilon)$ converges to $\sqrt{3}$ as ε tends to 0.*

We first need a preliminary technical lemma:

Lemma 2.8. *There exist $v_0 > 0$ and $\varepsilon_* > 0$ such that, for all m in the interval $[3, 7]$ (to fix ideas), $\varepsilon \in (0, \varepsilon_*)$ and any purely imaginary root iv of $P_7(\cdot; m, \varepsilon)$, with $v > 0$, it holds that $0 < v < v_0$.*

Proof. We observe that, if iv is a root of $P_7(\cdot; m, \varepsilon)$, then, in particular, the imaginary part of $P_7(iv; m, \varepsilon)$, i.e., the term $-a_0v^7 + a_2v^5 - a_4v^3 + a_6v$ vanishes.

A straightforward computation (see Appendix 2.6.3) reveals that

$$\begin{aligned} \operatorname{Im} P_7(i\zeta; m, \varepsilon) &= -2048(\varepsilon - 1)^4 \varepsilon^2 \zeta^7 - 8\varepsilon(m^2 + 3m + 2)\zeta^5 + O(\varepsilon^2)\zeta^5 \\ &\quad - 128(2m^4 - 7m^2 - 3m - 1)\zeta^3 + O(\varepsilon)\zeta^3 + a_6\zeta, \end{aligned}$$

for every $\zeta > 0$, where we denote by $O(\varepsilon^k)$ terms depending only on ε such that the ratio $O(\varepsilon^k)/\varepsilon^k$ stays bounded and far away from zero for ε in a neighborhood of zero. Since $m^2 + 3m + 2$ and $2m^4 - 7m^2 - 3m - 1$ are both positive for $m \in [3, \infty)$, we can estimate

$$|\operatorname{Im} P_7(i\zeta; m, \varepsilon)| \geq [8(m^2 + 3m + 2) - O(\varepsilon)]\varepsilon\zeta^5 + [128(2m^4 - 7m^2 - 3m - 1) - O(\varepsilon)]\zeta^3 - K|\zeta|,$$

where $K := \max\{|a_6(m, \varepsilon)| : m \in [3, 7], \varepsilon \in (0, 1]\}$. Hence, we can determine $\varepsilon_* > 0$ such that

$$|\operatorname{Im} P_7(i\zeta; m, \varepsilon)| \geq 64(2m^4 - 7m^2 - 3m - 1)\zeta^3 - K|\zeta|, \quad m \in [3, 7], \quad \varepsilon \in (0, \varepsilon_*). \quad (2.54)$$

The right-hand side of (2.54) diverges to ∞ as $\zeta \rightarrow +\infty$. From this it follows that there exists $v_0 > 0$ such that $|\operatorname{Im} P_7(i\zeta; m, \varepsilon)| > 0$ for every $\zeta > v_0$ and this clearly implies that $v \leq v_0$. \square

Proof of Proposition 2.7. We split the proof into two steps.

Step 1. First, we prove the existence of a function m^c with the properties listed in the statement of the proposition. For this purpose, we consider the sixth-order Hurwitz determinant $\Delta_6(m, \varepsilon)$ associated with the polynomial $P_7(\lambda; m, \varepsilon)$. It turns out that $\Delta_6(m, \varepsilon) = \varepsilon^2 m^2 C \tilde{\Delta}_6(m, \varepsilon)$ for some positive constant C . As $\varepsilon \rightarrow 0$, $\tilde{\Delta}_6(\cdot, \varepsilon)$ converges to the function

2. Stability analysis and Hopf bifurcation in a combustion model

Δ_0 , which is defined by

$$\begin{aligned}\Delta_0(m) = & -m^{18} + 8m^{17} + 97m^{16} + 42m^{15} - 2129m^{14} - 9376m^{13} - 16811m^{12} \\ & - 7866m^{11} + 19913m^{10} + 31292m^9 - 4309m^8 - 55466m^7 - 66363m^6 \\ & - 35480m^5 - 4729m^4 + 4666m^3 + 2628m^2 + 500m + 24.\end{aligned}$$

Noticing that $\Delta_0(6) = 0$ and $\frac{d}{dm}\Delta_0(6) > 0$, it then follows from the Implicit Function Theorem that there exist $\varepsilon_0 \in (0, \varepsilon_*)$, with ε_* given by Lemma 2.8, $\delta > 0$ and a unique mapping $m^c : (0, \varepsilon_0) \rightarrow (6 - \delta, 6 + \delta)$ with $m^c(0) = 6$, such that $\tilde{\Delta}_6(m^c(\varepsilon), \varepsilon) = 0$ and $\frac{\partial}{\partial m}\tilde{\Delta}_6(m^c(\varepsilon), \varepsilon) > 0$ for $\varepsilon \in (0, \varepsilon_0)$. Then, upon an application of Orlando formula, it follows that either 0 is a double root of $\tilde{P}_7(\lambda; \varepsilon)$ or there exists at least one pair $\pm\omega(\varepsilon)i$ (with $\omega(\varepsilon) > 0$) of purely imaginary roots of $\tilde{P}_7(\lambda; \varepsilon)$ for every $\varepsilon \in (0, \varepsilon_0)$. The first case is ruled out, since 0 is not a root of $\tilde{P}_7(\lambda; \varepsilon)$. Indeed, $a_7(m, \varepsilon)$ converges to a positive limit as ε tends to 0.

Step 2. Next, we prove that $\pm\omega(\varepsilon)i$ is the unique pair of purely imaginary roots of the polynomial $\tilde{P}_7(\lambda; \varepsilon)$ for every $\varepsilon \in (0, \varepsilon_0)$. For this purpose, we begin by observing that $\tilde{P}_7(\cdot; \varepsilon)$ converges, locally uniformly in \mathbb{C} as $\varepsilon \rightarrow 0$, to the fourth-order polynomial \tilde{P}_4 , defined by $\tilde{P}_4(\lambda) = -6272(4\lambda + 1)(\lambda - 12)(\lambda^2 + 3)$ for every $\lambda \in \mathbb{C}$. By Hurwitz Theorem, four roots of $\tilde{P}_7(\lambda; \varepsilon)$, say $\lambda_1(\varepsilon)$, $\lambda_2(\varepsilon)$, $\lambda_3(\varepsilon)$ and $\lambda_4(\varepsilon)$ converge respectively to $\lambda_1(0) = -\frac{1}{4}$, $\lambda_2(0) = 12$, $\lambda_3(0) = \sqrt{3}i$ and $\lambda_4(0) = -\sqrt{3}i$. More precisely, for $r_1 > 0$ small enough, $\lambda_i(\varepsilon)$ ($i = 1, \dots, 4$) is simple in the ball $B(\lambda_i(0), r_1)$ for $\varepsilon \in (0, \varepsilon_0)$ (up to replacing ε_0 with a smaller value if needed). Assume by contradiction that there exists a positive infinitesimal sequence $\{\varepsilon_n\}$ such that, for any $n \in \mathbb{N}$, $(\lambda_5(\varepsilon_n), \lambda_6(\varepsilon_n))$ is another pair of purely imaginary and conjugate roots of $\tilde{P}_7(\lambda; \varepsilon_n)$, different from $\pm\omega(\varepsilon_n)i$. By Lemma 2.8, $\nu(\varepsilon_n) = |\lambda_5(\varepsilon_n)| \leq v_0$ for every $n \in \mathbb{N}$. Take a subsequence $\{\varepsilon_{n_k}\}$ such that $\nu(\varepsilon_{n_k})$ converges as $k \rightarrow \infty$. The local uniform convergence in \mathbb{C} of $\tilde{P}_7(\cdot; \varepsilon_{n_k})$ to \tilde{P}_4 implies that $\nu(\varepsilon_{n_k})$ tends to $\sqrt{3}$ as $k \rightarrow \infty$. Since the limit is independent of the choice of subsequence $\{\varepsilon_{n_k}\}$, we conclude that $\nu(\varepsilon_n)$ converges to $\sqrt{3}$ as $n \rightarrow \infty$. Next, thanks to Hurwitz Theorem and the fact that $\lambda_3(\varepsilon)$, $\lambda_4(\varepsilon)$ converge to $\sqrt{3}i, -\sqrt{3}i$ respectively, the pair $(\lambda_5(\varepsilon_{n_k}), \lambda_6(\varepsilon_{n_k}))$ coincides with $(\lambda_3(\varepsilon_{n_k}), \lambda_4(\varepsilon_{n_k}))$ in $B(\sqrt{3}i, r_1) \times B(-\sqrt{3}i, r_1)$. This contradicts the fact that $\lambda_3(\varepsilon_{n_k}), \lambda_4(\varepsilon_{n_k})$ are both simple. Up to replacing ε_0 with a smaller value if needed, we have proved that $(\omega(\varepsilon)i, -\omega(\varepsilon)i)$ is the unique pair of conjugate eigenvalues of $\tilde{P}_7(\cdot; \varepsilon)$ and $\lambda_3(\varepsilon) = \omega(\varepsilon)i$ for every $\varepsilon \in (0, \varepsilon_0)$. The proof is now complete. \square

2.5.2 Hopf bifurcation theorem

For fixed $0 < \varepsilon < \varepsilon_0$, ε_0 and δ given by Proposition 2.7, let us consider the fully nonlinear problem (2.48), where now we find it convenient to write $F(\mathbf{w}; m)$ instead of $F(\mathbf{w})$ to make much more explicit the dependence of the nonlinear term F on the bifurcation parameter m . According to Proposition 2.7, the bifurcation parameter m has a critical value $m^c(\varepsilon) \in$

$(6 - \delta, 6 + \delta)$. We intend to prove that a Hopf bifurcation occurs at $m = m^c(\varepsilon)$ if ε is small enough. For m close to $m^c(\varepsilon)$, we are going to locally parameterize m and \mathbf{w} by a parameter $\sigma \in (-\sigma_0, \sigma_0)$. To emphasize this dependence, we will write $\tilde{m}(\sigma)$ and $\tilde{\mathbf{w}}(\cdot, \cdot; \sigma)$.

Theorem 2.9. *For any fixed $\alpha \in (0, 1)$, there exists $\tilde{\varepsilon}_0 \in (0, \varepsilon_0)$, such that whenever $\varepsilon \in (0, \tilde{\varepsilon}_0)$ is fixed, the following properties are satisfied.*

- (i) *There exist $\sigma_0 > 0$ and smooth functions $\tilde{m}, \rho : (-\sigma_0, \sigma_0) \rightarrow \mathbb{R}$, $\tilde{\mathbf{w}} : (-\sigma_0, \sigma_0) \rightarrow C^{1+\alpha}(\mathbb{R}; \mathcal{W}) \cap C^\alpha(\mathbb{R}; Q(D(L)))$, satisfying the conditions $\tilde{m}(0) = m^c$, $\rho(0) = 1$ and $\tilde{\mathbf{w}}(\cdot, \cdot; 0) = 0$. In addition, $\tilde{\mathbf{w}}(\cdot, \cdot; \sigma)$ is not a constant if $\sigma \neq 0$, and $\tilde{\mathbf{w}}(\cdot, \cdot; \sigma)$ is a $T(\sigma)$ -periodic solution of the equation*

$$\tilde{\mathbf{w}}_\tau(\cdot, \cdot; \sigma) = QL\tilde{\mathbf{w}}(\cdot, \cdot; \sigma) + F(\tilde{\mathbf{w}}(\cdot, \cdot; \sigma); \tilde{m}(\sigma)), \quad \tau \in \mathbb{R},$$

where $T(\sigma) = 2\pi\rho(\sigma)\omega^{-1}$ and $\omega = \omega(\varepsilon)$ is defined in Proposition 2.7.

- (ii) *There exists η_0 such that if $\bar{m} \in (6 - \delta_0, 6 + \delta_0)$, $\bar{\rho} \in \mathbb{R}$ and $\bar{\mathbf{w}} \in C^{1+\alpha}(\mathbb{R}; \mathcal{W}) \cap C^\alpha(\mathbb{R}; Q(D(L)))$ is a $2\pi\bar{\rho}\omega^{-1}$ -periodic solution of the equation $\bar{\mathbf{w}}_\tau = QL\bar{\mathbf{w}} + F(\bar{\mathbf{w}}; \bar{m})$ such that*

$$\|\bar{\mathbf{w}}\|_{C^{1+\alpha}(\mathbb{R}; \mathcal{W})} + \|\bar{\mathbf{w}}\|_{C^\alpha(\mathbb{R}; Q(D(L)))} + |\bar{m}| + |1 - \bar{\rho}| \leq \eta_0,$$

then there exist $\sigma \in (-\sigma_0, \sigma_0)$ and $\tau_0 \in \mathbb{R}$ such that $\bar{m} = \tilde{m}(\sigma)$, $\bar{\rho} = \rho(\sigma)$ and $\bar{\mathbf{w}} = \tilde{\mathbf{w}}(\cdot + \tau_0, \cdot; \sigma)$.

Proof. We split the proof into two steps.

Step 1. Here, we prove that there exists $\varepsilon_1 > 0$ such that $\pm\omega(\varepsilon)i$ are simple eigenvalues of L (and, hence, of the part of L in $\mathcal{W}_Q = Q(\mathcal{W})$) for every $\varepsilon \in (0, \varepsilon_1]$ and there are no other eigenvalues on the imaginary axis, i.e., we prove that this operator satisfies the so-called resonance condition.

To begin with, let us prove that $\pm\omega(\varepsilon)i$ are eigenvalues of L . In view of Theorem 2.3, we need to show that they are roots of the dispersion relation (2.49). For this purpose, we observe that the function $\tilde{D}_\varepsilon := D_\varepsilon(\cdot; m^c(\varepsilon))$ converges to \tilde{D}_0 locally uniformly in the strip $\{\lambda \in \mathbb{C} : |\operatorname{Re} \lambda| \leq \ell\}$ (for ℓ small enough), where

$$\tilde{D}_0(\lambda) = -\lambda - \frac{1 + \sqrt{1 + 4\lambda}}{2} + \frac{1}{14}[(13 + 2\lambda)\sqrt{1 + 4\lambda} + 1 + 4\lambda], \quad \lambda \in \mathbb{C}.$$

The function \tilde{D}_0 has just one pair of purely imaginary conjugate roots $\pm\sqrt{3}i$. Hurwitz theorem shows that there exists $r > 0$ such that the ball $B(\sqrt{3}i, r)$ contains exactly one root $\lambda(\varepsilon)$ of \tilde{D}_ε for each ε small enough. By the proof of Proposition 2.7, we know that there exists $r_1 > 0$ such that $\omega(\varepsilon)i$ is the unique root of \tilde{P}_7 in the ball $B(\sqrt{3}i, r_1)$. Clearly, $\lambda(\varepsilon)$ is a root of the polynomial \tilde{P}_7 and, Hurwitz theorem also shows that $\lambda(\varepsilon)$ converges to $\sqrt{3}i$

2. Stability analysis and Hopf bifurcation in a combustion model

as $\varepsilon \rightarrow 0^+$. Therefore, for ε small enough, both $\lambda(\varepsilon)$ and $\omega(\varepsilon)i$ belong to $B(\sqrt{3}i, r_1)$ and, hence, they do coincide. The same argument shows that $-\omega(\varepsilon)i$ is also a root of \tilde{D}_ε . We have proved that there exists $\varepsilon_1 \leq \varepsilon_0$ such that $\omega(\varepsilon)i$ and $-\omega(\varepsilon)i$ are both eigenvalues of L of every $\varepsilon \in (0, \varepsilon_1]$. In particular, $\pm\omega(\varepsilon)i$ are simple roots of the function \tilde{D}_ε and there are no other eigenvalues of L on the imaginary axis.

To conclude that $\pm\omega(\varepsilon)i$ are simple eigenvalues of L for each $\varepsilon \in (0, \varepsilon_1]$, we just need to check that their geometric multiplicity is one. For this purpose, we observe that the proof of Theorem 2.3 shows that the eigenfunctions associated with the eigenvalues $\pm\omega(\varepsilon)i$ are given by

$$\begin{aligned} u(\xi) &= c_1 e^{k_1 \xi} + \frac{A}{H_{1,\lambda}} \left(\frac{e^{k_3 \xi}}{k_3 - k_2} - \frac{e^{k_3 \xi} - e^{k_1 \xi}}{k_3 - k_1} \right) c_3, & v(\xi) &= c_3 e^{k_3 \xi}, & \xi < 0, \\ u(\xi) &= c_6 e^{k_2 \xi}, & v(\xi) &= c_8 e^{k_6 \xi}, & \xi \geq 0 \end{aligned}$$

with $k_j = k_{j, \pm\omega(\varepsilon)i}$ and the constants c_1, c_3, c_6 and c_8 are determined through the equation (2.33) (with $\lambda = \pm\omega(\varepsilon)i$) where $F_1 = \dots = F_4 = 0$. Since the rank of the matrix in (2.33) is three at $\lambda = \pm\omega(\varepsilon)i$, it follows at once that the geometric multiplicity of $\pm\omega(\varepsilon)i$ is one.

Step 2: Now, we check the nontransversality condition. We begin by observing that, for every $\varepsilon \in (0, \varepsilon_1]$, the function D_ε is analytic with respect to λ and continuously differentiable with respect to m in $B(\sqrt{3}i, r) \times (6 - \delta, 6 + \delta)$, where r is such that the ball $B(\sqrt{3}i, r)$ does not intersect the half line $(-\infty, -1/4]$. We intend to apply the Implicit Function Theorem at $(\omega(\varepsilon)i, m^c(\varepsilon))$ for ε small enough. In this respect, we need to show that the λ -partial derivative of D_ε does not vanish at $(\lambda_3(\varepsilon), m^c(\varepsilon))$. To this aim, we observe that

$$\lim_{\varepsilon \rightarrow 0^+} \frac{\partial D_\varepsilon}{\partial \lambda}(\omega(\varepsilon)i, m^c(\varepsilon)) = \frac{\partial D_0}{\partial \lambda}(\sqrt{3}i, 6) = \frac{5\sqrt{3}i - 3}{49}.$$

Therefore, there exists $\varepsilon_2 \leq \varepsilon_1$ such that, if $\varepsilon \in (0, \varepsilon_2]$, the λ -partial derivative of D_ε at $(\omega(\varepsilon)i, m^c(\varepsilon))$ does not vanish. Then, it follows from the Implicit Function Theorem that for each $\varepsilon \in (0, \varepsilon_2]$, there exist $\delta_\varepsilon > 0$, $r_\varepsilon < r$ and a C^1 -mapping $\lambda_\varepsilon : (m^c(\varepsilon) - \delta_\varepsilon, m^c(\varepsilon) + \delta_\varepsilon) \rightarrow B(\sqrt{3}i, r_\varepsilon)$, such that $D_\varepsilon(\lambda_\varepsilon(m), m) = 0$ for all $m \in (m^c(\varepsilon) - \delta_\varepsilon, m^c(\varepsilon) + \delta_\varepsilon)$ and $\lambda_\varepsilon(6) = \omega(\varepsilon)i$.

As a consequence, there are two branches of conjugate isolated and simple eigenvalues, $\lambda_\varepsilon(m)$ and $\bar{\lambda}_\varepsilon(m)$, which cross the imaginary axis respectively at $\pm\omega(\varepsilon)i$ for $m = m^c(\varepsilon)$.

It remains to determine the sign of the real part of the derivative of λ_ε at $m = m^c(\varepsilon)$. Since

$$\lim_{\varepsilon \rightarrow 0^+} \frac{\partial \lambda_\varepsilon}{\partial m}(m^c(\varepsilon)) = - \left(\frac{\partial D_0}{\partial m}(\sqrt{3}i, 6) \right) \left(\frac{\partial D_0}{\partial \lambda}(\sqrt{3}i, 6) \right)^{-1} = \frac{3}{4} + \frac{\sqrt{3}}{12}i$$

there exists $\varepsilon_3 \leq \varepsilon_2$ such that the real part of the derivative of λ_ε is positive at $m^c(\varepsilon)$ for any $\varepsilon \in (0, \varepsilon_3]$. which completes the proof of Step 2.

Applying [119, Theorem 9.3.3], the claims follow with $\tilde{\varepsilon}_0 = \varepsilon_3$. \square

2.5.3 Bifurcation from the traveling wave

As in Subsection 2.6, we rewrite the results in Theorem 2.9 in terms of problem (2.11)-(2.13). As above, ε is fixed in $(0, \tilde{\varepsilon}_0)$; therefore, the traveling wave \mathbf{U} depends only on m , which itself is parameterized by $\sigma \in (-\sigma_0, \sigma_0)$. Accordingly, the traveling wave reads $\tilde{\mathbf{U}}(\cdot; \sigma)$.

The following theorem expresses that there exists a bifurcated branch bifurcating from the traveling wave at the bifurcation point $m^c(\varepsilon)$. The proof can be obtained arguing as in the proof of Theorem 2.6. Hence, the details are skipped.

Theorem 2.10. *For each $\sigma \in (-\sigma_0, \sigma_0)$, the problem (2.11)-(2.13) admit a non trivial solution $(\tilde{\mathbf{X}}(\cdot, \cdot; \sigma), \tilde{g}(\cdot; \sigma))$ defined by:*

$$\begin{aligned} \tilde{\mathbf{X}}(\cdot, \cdot; \sigma) &= \Theta_i^{-1} \tilde{w}_1(\cdot, 0; \sigma) \tilde{\mathbf{U}}'(\cdot; \sigma) + \tilde{\mathbf{w}}(\cdot, \cdot; \sigma) + \tilde{\mathbf{U}}(\cdot; \sigma), \\ \tilde{g}(\tau; \sigma) &= \tau + \frac{\tau}{T(\sigma)} \int_0^{T(\sigma)} \frac{(L\tilde{\mathbf{w}}(r, \cdot; \sigma))_1(\sigma, 0^+)}{\Theta_i - \tilde{w}_1(r, 0; \sigma) - \tilde{w}'_1(r, 0^+; \sigma)} dr + \tilde{h}(\tau; \sigma), \quad \tau \in \mathbb{R}. \end{aligned}$$

where $\tilde{\mathbf{X}}(\cdot, \cdot; 0) = \tilde{\mathbf{U}}(\cdot; 0)$, $\tilde{\mathbf{w}}$ is defined by Theorem 2.9. The function $\tilde{h}(\cdot; \sigma)$ belongs to $C^{1+\alpha}(\mathbb{R})$. Moreover, $\tilde{\mathbf{X}}(\cdot, \cdot; \sigma)$ and $\tilde{h}(\cdot; \sigma)$ are periodic with period $T(\sigma) = 2\pi\rho(\sigma)\omega^{-1}$. At the bifurcation point, the “virtual period” is $T(0) = 2\pi\omega^{-1}$.

We refer to, e.g., [129, 117] for solutions which are periodic modulo a linear growth.

2.6 Appendix

2.6.1 General solution to the equation $\lambda \mathbf{u} - \mathcal{L}\mathbf{u} = \mathbf{f}$

Here, we collect the expression of the more general classical solution to the equation $\lambda \mathbf{u} - \mathcal{L}\mathbf{u} = \mathbf{f}$ when $\mathbf{f} = (f_1, f_2)$ is a continuous function and $\lambda \in \mathbb{C}$. We preliminarily note that, since $\text{Le} > 1$, the equation $k_{1,\lambda} = k_{4,\lambda}$ has no complex solutions λ . The equation $k_{1,\lambda} = k_{3,\lambda}$ admits two complex conjugate solutions

$$\lambda_j^* = \frac{-A\text{Le} + (-1)^j i \sqrt{A\text{Le}(\text{Le} - 1)}}{\text{Le} - 1}, \quad j = 1, 2, \quad (2.55)$$

whose real part is negative. Moreover, the equation $k_{2,\lambda} = k_{4,\lambda}$ admits no complex solutions. Also the equation $k_{1,\lambda} = k_{4,\lambda}$ admits no solutions. Indeed, squaring twice the equation $H_{1,\lambda} + H_{2,\lambda} = \text{Le} - 1$ we get λ_1^* and λ_2^* as solutions, which would imply that $k_{1,\lambda} = k_{2,\lambda}$. Obviously, this can not be the case.

Setting $\mathbf{u} = (u, v)$, it turns out that, for any $\mathbf{f} = (f_1, f_2) \in \mathcal{W}$ and $\lambda \neq \{\lambda_1^*, \lambda_2^*\}$, the general classical solution to the equation $\lambda \mathbf{u} - \mathcal{L}\mathbf{u} = \mathbf{f}$ is given by

$$\begin{aligned} u(\xi) &= \left(c_1 - \frac{1}{H_{1,\lambda}} \int_0^\xi (Av(s) + f_1(s)) e^{-k_{1,\lambda}s} ds \right) e^{k_{1,\lambda}\xi} + \left(c_2 + \frac{1}{H_{1,\lambda}} \int_0^\xi (Av(s) + f_1(s)) e^{-k_{2,\lambda}s} ds \right) e^{k_{2,\lambda}\xi} \\ &= \left\{ c_1 - \frac{A}{H_{1,\lambda}} \left[\frac{e^{(k_{3,\lambda} - k_{1,\lambda})\xi} - 1}{k_{3,\lambda} - k_{1,\lambda}} c_3 + \frac{e^{(k_{4,\lambda} - k_{1,\lambda})\xi} - 1}{k_{4,\lambda} - k_{1,\lambda}} c_4 \right] \right. \\ &\quad + \frac{A\text{Le}}{H_{1,\lambda}H_{2,\lambda}} \left[\frac{e^{(k_{3,\lambda} - k_{1,\lambda})\xi}}{k_{3,\lambda} - k_{1,\lambda}} \int_0^\xi f_2(s) e^{-k_{3,\lambda}s} ds - \frac{e^{(k_{4,\lambda} - k_{1,\lambda})\xi}}{k_{4,\lambda} - k_{1,\lambda}} \int_0^\xi f_2(s) e^{-k_{4,\lambda}s} ds \right. \\ &\quad \left. \left. + \frac{k_{3,\lambda} - k_{4,\lambda}}{(k_{4,\lambda} - k_{1,\lambda})(k_{3,\lambda} - k_{1,\lambda})} \int_0^\xi f_2(s) e^{-k_{1,\lambda}s} ds \right] \right. \\ &\quad \left. - \frac{1}{H_{1,\lambda}} \int_0^\xi f_1(s) e^{-k_{1,\lambda}s} ds \right\} e^{k_{1,\lambda}\xi} \\ &\quad + \left\{ c_2 + \frac{A}{H_{1,\lambda}} \left[\frac{e^{(k_{3,\lambda} - k_{2,\lambda})\xi} - 1}{k_{3,\lambda} - k_{2,\lambda}} c_3 + \frac{e^{(k_{4,\lambda} - k_{2,\lambda})\xi} - 1}{k_{4,\lambda} - k_{2,\lambda}} c_4 \right] \right. \\ &\quad + \frac{A\text{Le}}{H_{1,\lambda}H_{2,\lambda}} \left[\frac{e^{(k_{4,\lambda} - k_{2,\lambda})\xi}}{k_{4,\lambda} - k_{2,\lambda}} \int_0^\xi f_2(s) e^{-k_{4,\lambda}s} ds - \frac{e^{(k_{3,\lambda} - k_{2,\lambda})\xi}}{k_{3,\lambda} - k_{2,\lambda}} \int_0^\xi f_2(s) e^{-k_{3,\lambda}s} ds \right. \\ &\quad \left. \left. - \frac{k_{3,\lambda} - k_{4,\lambda}}{(k_{3,\lambda} - k_{2,\lambda})(k_{4,\lambda} - k_{2,\lambda})} \int_0^\xi f_2(s) e^{-k_{2,\lambda}s} ds \right] \right. \\ &\quad \left. + \frac{1}{H_{1,\lambda}} \int_0^\xi f_1(s) e^{-k_{2,\lambda}s} ds \right\} e^{k_{2,\lambda}\xi}, \quad (2.56) \end{aligned}$$

$$v(\xi) = \left(c_3 - \frac{\text{Le}}{H_{2,\lambda}} \int_0^\xi f_2(s) e^{-k_{3,\lambda}s} ds \right) e^{k_{3,\lambda}\xi} + \left(c_4 + \frac{\text{Le}}{H_{2,\lambda}} \int_0^\xi f_2(s) e^{-k_{4,\lambda}s} ds \right) e^{k_{4,\lambda}\xi} \quad (2.57)$$

for $\xi < 0$ and

$$u(\xi) = \left(c_5 - \frac{1}{H_{1,\lambda}} \int_0^\xi f_1(s) e^{-k_{1,\lambda}s} ds \right) e^{k_{1,\lambda}\xi} + \left(c_6 + \frac{1}{H_{1,\lambda}} \int_0^\xi f_1(s) e^{-k_{2,\lambda}s} ds \right) e^{k_{2,\lambda}\xi}, \quad (2.58)$$

$$v(\xi) = \left(c_7 - \frac{\text{Le}}{H_{3,\lambda}} \int_0^\xi f_2(s) e^{-k_{5,\lambda}s} ds \right) e^{k_{5,\lambda}\xi} + \left(c_8 + \frac{\text{Le}}{H_{3,\lambda}} \int_0^\xi f_2(s) e^{-k_{6,\lambda}s} ds \right) e^{k_{6,\lambda}\xi}, \quad (2.59)$$

for $\xi \geq 0$. Here, $H_{i,\lambda}$ ($i = 1, 2, 3$) and $k_{j,\lambda}$ ($j = 1, \dots, 6$) are defined by (2.24)-(2.25).

If $\lambda \in \{\lambda_1^*, \lambda_2^*\}$, then $k_{1,\lambda} = k_{3,\lambda}$. Hence, in the definition of u for $\xi < 0$, the term

$$\begin{aligned} & - \frac{A(e^{k_{3,\lambda}-k_{1,\lambda}} - 1)}{H_{1,\lambda}(k_{3,\lambda} - k_{1,\lambda})} c_3 \\ & + \frac{A\text{Le}}{H_{1,\lambda}H_{2,\lambda}} \left[\frac{e^{(k_{3,\lambda}-k_{1,\lambda})\xi}}{k_{3,\lambda} - k_{1,\lambda}} \int_0^\xi f_2(s) e^{-k_{3,\lambda}s} ds + \frac{k_{3,\lambda} - k_{4,\lambda}}{(k_{3,\lambda} - k_{1,\lambda})(k_{4,\lambda} - k_{1,\lambda})} \int_0^\xi f_2(s) e^{-k_{1,\lambda}s} ds \right] \end{aligned}$$

should be replaced by

$$- \frac{A}{H_{1,\lambda}} c_3 \xi - \frac{A\text{Le}}{H_{1,\lambda}H_{2,\lambda}} \int_0^\xi (s - \xi) f_2(s) e^{-k_{3,\lambda}s} ds - \frac{A\text{Le} e^{(k_{4,\lambda}-k_{1,\lambda})\xi}}{H_{1,\lambda}H_{2,\lambda}(k_{4,\lambda} - k_{1,\lambda})} \int_0^\xi f_2(s) e^{-k_{4,\lambda}s} ds.$$

2.6.2 On the equality $k_{1,\lambda} = k_{3,\lambda}$

Here, we show that the solutions of the equation $k_{1,\lambda} = k_{3,\lambda}$, i.e., the complex numbers given by (2.55), are not solutions of the dispersion relation. Since $(\text{Le}^2 + 4\text{Le}(A + \lambda_j^*))^{1/2} = \text{Le} - 1 + (1 + 4\lambda_j^*)^{1/2}$, it is easy to see that $D(\lambda_j^*, \Theta_i, \text{Le}) = 0$ if and only if

$$\begin{aligned} & \sqrt{\text{Le} + 4\lambda\text{Le}} \left[1 \pm 2i \frac{\sqrt{A\text{Le}}}{\sqrt{\text{Le} - 1}} + (\Theta_i - 1) \left(1 - \frac{4A\text{Le}}{\text{Le} - 1} \pm 4i \frac{\sqrt{A\text{Le}}}{\sqrt{\text{Le} - 1}} \right) \right] \\ & = 2A\text{Le} - \left(\text{Le} \pm 2i \frac{\sqrt{A\text{Le}}}{\sqrt{\text{Le} - 1}} \right) \left[1 \pm 2i \frac{\sqrt{A\text{Le}}}{\sqrt{\text{Le} - 1}} + (\Theta_i - 1) \left(1 - \frac{4A\text{Le}}{\text{Le} - 1} \pm 4i \frac{\sqrt{A\text{Le}}}{\sqrt{\text{Le} - 1}} \right) \right]. \end{aligned} \quad (2.60)$$

Squaring both sides of (2.60) and identifying real and imaginary parts of the so obtained equation, after some long but straightforward computation we get the following system for Le and Θ_i :

$$\begin{cases} \Theta_i^2 + A\text{Le} + 16(\Theta_i - 1)^2 \frac{A^2\text{Le}^2}{(\text{Le} - 1)^2} - 8 \frac{A\text{Le}}{\text{Le} - 1} \Theta_i (\Theta_i - 1) (3\Theta_i - 1) - \Theta_i \text{Le} + 4(\Theta_i - 1) \frac{A\text{Le}^2}{\text{Le} - 1} = 0, \\ 4A\text{Le}(\Theta_i - 1)(4\Theta_i - 3) + (\text{Le} - 1)(3\Theta_i - 4\Theta_i^2 - \text{Le} + 2\Theta_i \text{Le}) = 0. \end{cases} \quad (2.61)$$

First, we consider the second equation in (2.61). Replacing A with its value given by (2.8)

2. Stability analysis and Hopf bifurcation in a combustion model

and solving the so obtained equation with respect to Le , we obtain that there are no positive solutions if $\Theta_i = 1/2$ and, when $\Theta_i \in (0, 1) \setminus \{1/2\}$, then the equation has two real solutions

$$Le_{\pm} = \frac{20\Theta_i^2 - 13\Theta_i - 1 \pm (400\Theta_i^4 - 552\Theta_i^3 + 169\Theta_i^2 + 14\Theta_i + 1)^{\frac{1}{2}}}{2\Theta_i - 1}.$$

A straightforward computation reveals that $Le_- > 1$ if and only if $\Theta_i \leq 1/2$, whereas $Le_+ > 1$ if and only if $\Theta_i \in (\bar{\Theta}_i, 1)$, where the value $\bar{\Theta}_i = (4 + \sqrt{22})/12 \approx 0.724$ will play a significant role hereafter.

Now, we go back to the first equation in (2.61). Replacing A by its value, given by (2.8), and taking $Le = Le_{\pm}$, we get the following equation

$$p(\Theta_i) = (\text{signum}(1 - 2\Theta_i))(1 - \Theta_i)q(\Theta_i)\sqrt{400\Theta_i^4 - 552\Theta_i^3 + 169\Theta_i^2 + 14\Theta_i + 1} \quad (2.62)$$

for $\Theta_i \in (0, 1/2) \cup (\bar{\Theta}_i, 1)$, where

$$\begin{aligned} p(\Theta_i) &= -38400\Theta_i^9 + 296896\Theta_i^8 - 800896\Theta_i^7 + 1041468\Theta_i^6 - 698658\Theta_i^5 + 218492\Theta_i^4 - 14718\Theta_i^3 \\ &\quad - 3894\Theta_i^2 - 298\Theta_i - 8, \\ q(\Theta_i) &= 1920\Theta_i^6 - 11600\Theta_i^5 + 19164\Theta_i^4 - 12038\Theta_i^3 + 2174\Theta_i^2 + 251\Theta_i + 8. \end{aligned}$$

It follows from the next lemma that (2.62) admits no solutions in the set $(0, 1/2) \cup (\bar{\Theta}_i, 1)$ and, consequently, the solutions of $k_{1,\lambda} = k_{3,\lambda}$ are not zeros of the dispersion relation.

Lemma 2.11. *Function q is positive in $(0, 1/2)$ and negative in $(\bar{\Theta}_i, 1)$. On the contrary, p is negative in $(0, 1/2)$ and positive in $(\bar{\Theta}_i, 1)$.*

Proof. Since the proof is easy but rather technical, we sketch it. In what follows, we denote by c positive constants which may vary from line to line. Similarly, by p_k and q_k we denote polynomials of degree k , which may vary from estimate to estimate.

We begin by considering the function q . For $\Theta_i \in (0, 1/2)$, we can estimate the sum of the first three terms in the definition of q by $13364\Theta_i^4$, so that $q(\Theta_i) > \Theta_i(13364\Theta_i^3 - 12038\Theta_i^2 + 2174\Theta_i + 251) + 8$ and the right-hand side of the previous inequality is not less than $-2\Theta_i + 8$, so that q is positive in $(0, 1/2)$.

For $\Theta_i \in (\bar{\Theta}_i, 1)$ things are a bit trickier. Obviously, it suffices to prove that q is negative in $(7/10, 1)$. For this purpose, we observe that, since $q(7/10) < 0$, we can estimate $q < q - q(7/10) =: q_5$ in such an interval and

$$\begin{aligned} q_5(\Theta_i) &< c\Theta_i(10\Theta_i - 7)(120000\Theta_i^4 - 641000\Theta_i^3 + 749050\Theta_i^2 - 228040\Theta_i - 23753) \\ &= c\Theta_i(10\Theta_i - 7)[(10\Theta_i - 7)(24000\Theta_i^3 - 111400\Theta_i^2 + 71830\Theta_i + 4673) - 73975]. \end{aligned} \quad (2.63)$$

Computing the maximum value of the above third-order polynomial in the interval $(7/10, 1)$, we conclude that $q(\Theta_i) < c\Theta_i(10\Theta_i - 7)[17217(10\Theta_i - 7) - 73975]$, whose right-hand side is negative if $\Theta_i \in (7/10, \widehat{\Theta}_i)$, where $\widehat{\Theta}_i = 67657/86085 \approx 0.786$. On the other hand, if $\Theta_i \in [\widehat{\Theta}_i, 1)$, we can subtract from the fourth-order polynomial on the first line of (2.63) its value at $\widehat{\Theta}_i$ (which is negative) and, thus, estimate $q(\Theta_i) \leq c\Theta_i(10\Theta_i - 7)(\Theta_i - \widehat{\Theta}_i)q_3(\Theta_i)$, and q_3 is negative in the interval $[\widehat{\Theta}_i, 1)$, as it is easily seen. Thus, q is negative in $(\overline{\Theta}_i, 1)$ as claimed.

Next, we consider function p , first addressing the case when $\Theta_i \in (0, 1/2)$. Note that $p(\Theta_i) < p(\Theta_i) - p(0) = \Theta_i p_8(\Theta_i) < \Theta_i(p_8(\Theta_i) - p_8(1/2)) = c\Theta_i(1 - 2\Theta_i)p_7(\Theta_i)$ for every $\Theta_i \in (0, 1/2)$. Iterating this procedure, in the end we deduce that $p(\Theta_i) < c\Theta_i^3(1 - 2\Theta_i)^3 p_4(\Theta_i)$ for each $\Theta_i \in (0, 1/2)$. Since $p_4(\Theta_i) < p_4(\Theta_i) - p_4(1/2) = c(1 - 2\Theta_i)p_3(\Theta_i)$ for every $\Theta_i \in (0, 1/2)$ and p_3 is negative in $(0, 1/2)$, $p(\Theta_i)$ is negative for each $\Theta_i \in (0, 1/2)$.

Let us now assume that $\Theta_i \in (\overline{\Theta}_i, 1)$. Since $\overline{\Theta}_i > 18/25 =: \widetilde{\Theta}_i$, we can limit ourselves to proving that p is negative in $(\widetilde{\Theta}_i, 1)$. For this purpose, we observe that

$$\begin{aligned} p(\Theta_i) &< p(\Theta_i) - p(\widetilde{\Theta}_i) = c(\widetilde{\Theta}_i - \Theta_i)p_8(\Theta_i) < c(\widetilde{\Theta}_i - \Theta_i)[p_8(\Theta_i) - p_8(\widetilde{\Theta}_i)] = -c(\widetilde{\Theta}_i - \Theta_i)^2 p_7(\Theta_i) \\ &< -c(\widetilde{\Theta}_i - \Theta_i)^2 [p_7(\Theta_i) - p_7(1)] = c(\widetilde{\Theta}_i - \Theta_i)^2 (1 - \Theta_i)p_6(\Theta_i). \end{aligned}$$

If $\Theta_i \in [0.745, 0.75]$ then we estimate $\Theta_i^k \leq 75 \cdot 10^{-2k}$ for $k = 4, 6$, $\Theta_i^k \geq 745 \cdot 10^{-3k}$ for $k = 1, 2, 3, 5$, and conclude that p_6 and, hence, p is negative in $[0.745, 0.75]$. For $\Theta_i \in (0.75, 1)$, we estimate $p_6(\Theta_i) < p_6(\Theta_i) - p_6(3/4) = c(4\Theta_i - 3)p_5(\Theta_i)$. Iterating this procedure, we conclude that $p_6(\Theta_i) < (4\Theta_i - 3)^3 p_3(\Theta_i)$ and the polynomial p_3 is negative in $(0.75, 1)$. Finally, if $\Theta_i \in (0.72, 0.745)$ then we set $\overline{\Theta}_i = 0.745$, estimate

$$\begin{aligned} p_6(\Theta_i) &< (p_6(\Theta_i) - p_6(\overline{\Theta}_i)) < c(\Theta_i - \overline{\Theta}_i)p_5(\Theta_i) < c(\Theta_i - \overline{\Theta}_i)(p_5(\Theta_i) - p_5(\overline{\Theta}_i)) \\ &= c(\Theta_i - \overline{\Theta}_i)^2 p_4(\Theta_i) \leq c(\Theta_i - \overline{\Theta}_i)^2 (p_4(\Theta_i) - p_4(\widetilde{\Theta}_i)) = c(\Theta_i - \widetilde{\Theta}_i)(\Theta_i - \overline{\Theta}_i)^2 p_3(\Theta_i) \end{aligned}$$

and observe that p_3 is negative in $[0.72, 0.745)$. Thus, p is negative in this interval as well. Summing up, we have proved that p is negative in $(\widetilde{\Theta}_i, 1)$ as claimed. This concludes the proof. \square

2.6.3 The coefficients of the polynomial $P_7(\cdot; m, \varepsilon)$

We collect here the expression of the coefficients $a_i = a_i(m, \varepsilon)$ ($i = 0, 1, \dots, 7$) of the polynomial $P_7(\lambda; m, \varepsilon) = a_0\lambda^7 + a_1\lambda^6 + a_2\lambda^5 + a_3\lambda^4 + a_4\lambda^3 + a_5\lambda^2 + a_6\lambda + a_7$, which appears in

2. Stability analysis and Hopf bifurcation in a combustion model

Subsection 2.5.1. They are given by

$$a_0 = 2^{11}(\varepsilon - 1)^4\varepsilon^2;$$

$$a_1 = -2^{11}(\varepsilon^2 - \varepsilon)^2[(5\varepsilon^2 - 2\varepsilon + 1)m^2 + 2(\varepsilon + 1)^2m + 4];$$

$$a_2 = (\varepsilon^2 - \varepsilon)[\varepsilon(59\varepsilon^3 - 9\varepsilon^2 + 17\varepsilon - 3)m^4 + 4\varepsilon(15\varepsilon^3 + 15\varepsilon^2 + 17\varepsilon + 1)m^3 \\ + 4(\varepsilon + 2)(\varepsilon^3 + 9\varepsilon^2 + 5\varepsilon + 1)m^2 - 8(2\varepsilon^3 - 3\varepsilon^2 - 4\varepsilon - 3)m - 8(\varepsilon - 1)(\varepsilon + 2)];$$

$$a_3 = 2^7[-\varepsilon^2(5\varepsilon - 1)(9\varepsilon^3 + \varepsilon^2 + 7\varepsilon - 1)m^6 - 2\varepsilon^2(59\varepsilon^4 - 8\varepsilon^3 + 74\varepsilon^2 + 8\varepsilon - 5)m^5 \\ - 4\varepsilon(4\varepsilon^5 + 27\varepsilon^4 + 24\varepsilon^3 + 37\varepsilon^2 + 6\varepsilon - 2)m^4 + 4\varepsilon(4\varepsilon^5 + 20\varepsilon^4 - 31\varepsilon^3 - 23\varepsilon^2 - 33\varepsilon - 1)m^3 \\ + 4(9\varepsilon^5 + 27\varepsilon^4 - 15\varepsilon^3 - 24\varepsilon^2 - 12\varepsilon - 1)m^2 + 4(\varepsilon^4 + 17\varepsilon^3 - 7\varepsilon^2 - 9\varepsilon - 2)m - 4(\varepsilon - 1)^2(2\varepsilon + 1)];$$

$$a_4 = 2^3[\varepsilon^2(9\varepsilon - 1)^2(\varepsilon - 1)^2m^8 + 8\varepsilon^2(\varepsilon - 1)(45\varepsilon^3 + 5\varepsilon^2 - 21\varepsilon + 3)m^7 \\ + 8\varepsilon(21\varepsilon^5 - 58\varepsilon^4 - 84\varepsilon^3 - 32\varepsilon^2 + 27\varepsilon - 2)m^6 - 16\varepsilon(34\varepsilon^5 + 42\varepsilon^4 + 113\varepsilon^3 + 81\varepsilon^2 - 7\varepsilon - 7)m^5 \\ - 16(7\varepsilon^6 + 96\varepsilon^5 + 75\varepsilon^4 + 176\varepsilon^3 + 42\varepsilon^2 - 10\varepsilon - 2)m^4 + 16\varepsilon(6\varepsilon^4 - 75\varepsilon^3 - 65\varepsilon^2 - 117\varepsilon - 5)m^3 \\ + 16(29\varepsilon^4 - 7\varepsilon^3 - 48\varepsilon^2 - 31\varepsilon - 7)m^2 + 32(\varepsilon - 1)(7\varepsilon^2 + 14\varepsilon + 3)m - 16(\varepsilon - 1)^2];$$

$$a_5 = 2^5m[\varepsilon^2(\varepsilon - 1)^2(9\varepsilon^2 + \varepsilon - 2)m^7 + (\varepsilon^2 - \varepsilon)(38\varepsilon^4 + 46\varepsilon^3 - 39\varepsilon^2 + 3)m^6 \\ + (36\varepsilon^6 + 33\varepsilon^5 - 123\varepsilon^4 - 95\varepsilon^3 + 54\varepsilon^2 - 1)m^5 \\ - (8\varepsilon^6 - 8\varepsilon^5 + 169\varepsilon^4 + 233\varepsilon^3 + 25\varepsilon^2 - 41\varepsilon - 2)m^4 \\ - (60\varepsilon^5 + 110\varepsilon^4 + 320\varepsilon^3 + 129\varepsilon^2 - 22\varepsilon - 21)m^3 \\ - 4(16\varepsilon^4 + 37\varepsilon^3 + 41\varepsilon^2 + 7\varepsilon - 5)m^2 + 2(4\varepsilon^3 - 37\varepsilon^2 - 10\varepsilon - 5)m + 4(5\varepsilon^2 - 2\varepsilon - 3)];$$

$$a_6 = 2^3m[2\varepsilon^2(\varepsilon - 1)^2(\varepsilon + 1)(2\varepsilon - 1)m^7 + (\varepsilon^2 - \varepsilon)(16\varepsilon^4 + 58\varepsilon^3 - 19\varepsilon^2 - 10\varepsilon + 3)m^6 \\ + (16\varepsilon^6 + 72\varepsilon^5 - 39\varepsilon^4 - 171\varepsilon^3 + 42\varepsilon^2 + 17\varepsilon - 1)m^5 \\ + 2(20\varepsilon^5 - 12\varepsilon^4 - 113\varepsilon^3 - 69\varepsilon^2 + 41\varepsilon + 5)m^4 - (2\varepsilon + 1)(18\varepsilon^3 + 81\varepsilon^2 + 80\varepsilon - 51)m^3 \\ - 4(28\varepsilon^3 + 31\varepsilon^2 + 20\varepsilon - 15)m^2 - 4(11\varepsilon - 3)(\varepsilon + 1)m - 8(1 - \varepsilon)];$$

$$a_7 = 2^4(m^2 + m^3)[\varepsilon^2(\varepsilon^2 - 1)(2\varepsilon - 1)m^4 + \varepsilon(2\varepsilon - 1)(3\varepsilon^2 - 3\varepsilon - 2)m^3 \\ + (2\varepsilon^4 - 13\varepsilon^2 + 4\varepsilon + 1)m^2 - 3(2\varepsilon - 1)(\varepsilon + 1)m + 2(1 - 2\varepsilon)].$$

Chapter 3

Spreading speeds and pulsating fronts for a field-road model in a spatially periodic habitat¹

3.1 Introduction

The goal of this paper is to investigate propagation properties for a field-road model in a spatially periodic environment. Taking into account this heterogeneity in space, we shall establish the existence of the asymptotic spreading speed and its coincidence with the minimal wave speed of pulsating traveling fronts in the direction of the road. In this paper, the line $\{(x, 0) : x \in \mathbb{R}\}$ will be referred to as the road in the plane \mathbb{R}^2 . The heterogeneity is assumed to appear in x -direction. Then by symmetry, we can consider the upper half-plane $\Omega := \{(x, y) \in \mathbb{R}^2 : y > 0\}$ as the field. Denote by $u(t, x)$ the linear density of population on the road and by $v(t, x, y)$ the areal density of population in the field. Such a model can be understood as the low-dimensional case of the “bulk-surface model” (involving volumetric densities and surface densities) where the surface has no thickness. The population in the field is assumed to be governed by a Fisher-KPP equation with diffusivity d and heterogeneous nonlinearity $f(x, v)$, whereas the population on the road is subject to a diffusion equation with diffusivity $D > 0$ which is a priori different from d . Moreover, there are exchanges of populations between the road and the field in which the parameter $\mu > 0$ stands for the rate of individuals on the road going into the field, while the parameter $\nu > 0$ represents the rate of individuals passing from the field to the road. Therefore, we are led to the following

¹This work is submitted.

3. Spreading speeds and pulsating fronts for a field-road model in a periodic habitat

system:

$$\begin{cases} \partial_t u - D\partial_{xx}u = \nu v(t, x, 0) - \mu u, & t > 0, x \in \mathbb{R}, \\ \partial_t v - d\Delta v = f(x, v), & t > 0, (x, y) \in \Omega, \\ -d\partial_y v(t, x, 0) = \mu u - \nu v(t, x, 0), & t > 0, x \in \mathbb{R}. \end{cases} \quad (3.1)$$

We assume that the reaction term $f(x, v)$ depends on the x variable in a periodic fashion. As a simple example, f may be of the type $f(x, v) = a(x)v(1-v)$ in which the periodic coefficient $a(x)$ can be interpreted as an effective birth rate of the population. In models of biological invasions, the heterogeneity may be a consequence of the presence of highly differentiated zones such as forests, rivers, grasslands, roads, villages, etc., where the species in consideration may tend to reproduce or die with different rates from one place to another. Therefore, it is a fundamental problem to understand how heterogeneity influences the characteristics of front propagation such as front speeds and front profiles.

Let us recall the origin of this model and relevant results. The field-road model was first introduced by Berestycki, Roquejoffre and Rossi [30] in 2013 where all parameters are homogeneous. The authors proved that a strong diffusion on the road enhances global invasion in the field. More precisely, denote by w^* the asymptotic spreading speed in the direction of the road for the homogeneous field-road model and by $c_{KPP} := 2\sqrt{df'(0)}$ the spreading speed for the scalar KPP equation $u_t - du_{xx} = f(u)$, they proved that: if $D \leq 2d$, then $w^* = c_{KPP}$; if $D > 2d$, then $w^* > c_{KPP}$. Moreover, they showed that the propagation velocity on the road increases indefinitely as D grows to infinity. As a sequel, the same authors introduced in [31] transport and mortality on the road to understand the resulting new effects. Let us point out that the original model was considered in a homogeneous frame, which means that every place in the field is equivalently suitable for the survival of species, whereas this homogeneity assumption is hardly satisfied in natural environments. Therefore, it is of the essence to take into account the heterogeneity of the medium. Later on, it was proved in [13, 32] that the road enhances the asymptotic speed of propagation in a cone of directions. The paper [33] established the existence of standard traveling fronts for this homogeneous system for $c \geq w^*$. Giletti, Monsaingeon and Zhou [84] considered this model with spatially periodic exchange coefficients:

$$\begin{cases} \partial_t u - D\partial_{xx}u = \nu(x)v(t, x, 0) - \mu(x)u, & t > 0, x \in \mathbb{R}, \\ \partial_t v - d\Delta v = f(v), & t > 0, (x, y) \in \Omega, \\ -d\partial_y v(t, x, 0) = \mu(x)u(t, x) - \nu(x)v(t, x, 0), & t > 0, x \in \mathbb{R}, \end{cases}$$

where $\mu(x), \nu(x)$ are L -periodic in x in $C^{1,r}(\mathbb{R})$, and $\mu(x), \nu(x) \geq \not\equiv 0$. They recovered the same diffusion threshold $D = 2d$ in [30]. In 2016, Tellini [152] studied the homogeneous field-road model in a strip with an imposed Dirichlet boundary condition on the other side of the strip. It is noticed that traveling fronts were just studied in [33] for the original homogeneous

model and in [57] for a truncated problem with ignition-type nonlinearity.

Related results were also obtained in various frameworks. The case of a fractional diffusion on the road was treated in [13, 14]. Nonlocal exchanges were studied in [134, 135]. Models with an ignition-type nonlinearity were considered in [57, 58]. The field-road model set in an infinite cylinder with fast diffusion on the surface was investigated in [140]. The case where the field is a cone was studied in [63]. The authors in [16] discussed the effect of the road on a population in an ecological niche facing climate change based on the notion of generalized principal eigenvalues for heterogeneous road-field systems developed in [15]. Propagation phenomena for heterogeneous KPP bulk-surface systems in a cylindrical domain was investigated recently in [34]. The existence of weak solutions to an elliptic problem in bounded and unbounded strips motivated by the field-road model was discussed in [52]. An interesting but different field-road model where the road is with very thin width was introduced in [111] using the so-called effective boundary conditions to study speed enhancement and the asymptotic spreading speed.

By contrast with standard periodic reaction-diffusion equations, the mathematical study of (3.1) contains the following difficulties: firstly, the periodic assumption only set on x variable but not on y leads to the noncompactness of the domain, therefore the existence of pulsating fronts cannot be obtained by PDE's methods easily. Secondly, due to the heterogeneous hypothesis on f , the situation is much more involved so that we are not able to derive precise threshold result of speed enhancement with respect to different diffusivities on the road and in the field. Thirdly, in terms of the generalized eigenvalue problem in the half-plane, one of main technical difficulties is to get some estimates for the generalized principal eigenfunction pair. To the best of our knowledge, there has been no known result about the existence of generalized traveling fronts for the field-road model in heterogeneous media up to now.

The aim of this work is to prove the existence of the asymptotic spreading speed c^* as well as its coincidence with the minimal speed of pulsating traveling fronts along the road for (3.1) in a spatially periodic habitat. Our strategy is to study a truncated problem with an imposed zero Dirichlet upper boundary condition as a first step. Specifically, by application of principal eigenvalue theory and of dynamical system method, we show the existence of the asymptotic spreading speed c_R^* as well as its coincidence with the minimal speed of pulsating traveling fronts along the road. We further give a variational formula for c_R^* by using the principal eigenvalue of certain linear elliptic problem. Based on the study of the truncated problem, we eventually go back to the analysis of the original problem in the half-plane by combining generalized principal eigenvalue approach with an asymptotic method. Let us mention that the results in this paper can also be adapted to the case of periodic exchange coefficients treated in [84].

For general reaction-diffusion problems, there have been lots of remarkable works on spreading properties and pulsating traveling fronts. We refer to [155, 17, 22, 113, 114, 23,

25, 98] and references therein.

3.2 Hypotheses and main results

Throughout this paper, we assume that $f: \mathbb{R} \times \mathbb{R}_+ \rightarrow \mathbb{R}$ is of class $C^{1,\delta}$ in (x, v) (with $0 < \delta < 1$) and C^2 in v , L -periodic in x , and satisfies the KPP assumption:

$$f(\cdot, 0) \equiv 0 \equiv f(\cdot, 1), \quad 0 < f(\cdot, v) \leq f_v(\cdot, 0)v \text{ for } v \in (0, 1), \quad f(\cdot, v) < 0 \text{ for } v \in (1, +\infty).$$

Define $M := \max_{[0,L]} f_v(x, 0)$ and $m := \min_{[0,L]} f_v(x, 0)$. Then $M \geq m > 0$. We further assume that

$$\forall x \in \mathbb{R}, \quad v \mapsto \frac{f(x, v)}{v} \text{ is decreasing in } v > 0.$$

In what follows, as far as the Cauchy problem is concerned, we always assume that the initial condition (u_0, v_0) is nonnegative, bounded and continuous.

We now present our results in this paper. As a first step, we focus on the following truncated problem with an imposed Dirichlet upper boundary condition:

$$\begin{cases} \partial_t u - D\partial_{xx}u = \nu v(t, x, 0) - \mu u, & t > 0, \quad x \in \mathbb{R}, \\ \partial_t v - d\Delta v = f(x, v), & t > 0, \quad (x, y) \in \Omega_R, \\ -d\partial_y v(t, x, 0) = \mu u - \nu v(t, x, 0), & t > 0, \quad x \in \mathbb{R}, \\ v(t, x, R) = 0, & t > 0, \quad x \in \mathbb{R}, \end{cases} \quad (3.2)$$

in which $\Omega_R := \{(x, y) \in \mathbb{R} : 0 < y < R\}$ denotes a truncated domain with width R sufficiently large. In fact, the width R of the strip plays a crucial role in long time behavior of the corresponding Cauchy problem (3.2) due to the zero Dirichlet upper boundary condition. A natural explanation, from the biological point of view, is that if the width of the strip is not sufficiently large, the species may finally extinct because of the effect of unfavorable Dirichlet condition on the upper boundary. Therefore, we shall give a sufficient condition on R such that the species can persist successfully. Here is our statement.

Theorem 3.1. *If*

$$m > \frac{d\pi^2}{4R^2}, \quad (3.3)$$

then (3.2) admits a unique nontrivial nonnegative stationary solution (U_R, V_R) , which is L -periodic in x . Moreover, let (u, v) be the solution of (3.2) with a nonnegative, bounded and continuous initial datum $(u_0, v_0) \not\equiv (0, 0)$, then

$$\lim_{t \rightarrow +\infty} (u(t, x), v(t, x, y)) = (U_R(x), V_R(x, y)) \text{ locally uniformly in } (x, y) \in \overline{\Omega}_R. \quad (3.4)$$

Remark 3.2. In particular, when the environment is homogeneous, i.e. $f(x, v) \equiv f(v)$, R should satisfy $4R^2 f'(0) > d\pi^2$, which coincides with the condition in [152]. Let $R_* > 0$ be such that $m = \frac{d\pi^2}{4R_*^2}$. For any $R > R_0 := 2R_*$, (3.3) is satisfied and there also holds $m = \frac{d\pi^2}{R_0^2} > \frac{d\pi^2}{R^2}$. Throughout the paper, as far as the truncated problem is concerned, it is not restrictive to assume that $R > R_0$ (since our concern is to take $R \rightarrow +\infty$ to consider (3.1)), which will be convenient to prove the positivity of the asymptotic spreading speed c_R^* for problem (3.2).

Let (U_R, V_R) be the unique nontrivial nonnegative stationary solution of (3.2) in the sequel. We are now in a position to investigate spreading properties of solutions to (3.2) in $\overline{\Omega}_R$, which is based on dynamical system method and principal eigenvalue theory.

We first consider the following eigenvalue problem in the strip $\overline{\Omega}_R$:

$$\begin{cases} -D\phi'' + 2D\alpha\phi' + (-D\alpha^2 + \mu)\phi - \nu\psi(x, 0) = \sigma\phi, & x \in \mathbb{R}, \\ -d\Delta\psi + 2d\alpha\partial_x\psi - (d\alpha^2 + f_v(x, 0))\psi = \sigma\psi, & (x, y) \in \Omega_R, \\ -d\partial_y\psi(x, 0) + \nu\psi(x, 0) - \mu\phi = 0, & x \in \mathbb{R}, \\ \psi(x, R) = 0, & x \in \mathbb{R}, \\ \phi, \psi \text{ are } L\text{-periodic with respect to } x. \end{cases} \quad (3.5)$$

The compactness of the domain allows us to apply the classical Krein-Rutman theory which provides the existence of the principal eigenvalue $\lambda_R(\alpha) \in \mathbb{R}$ and the associated unique (up to multiplication by some constant) positive principal eigenfunction pair $(P_{\alpha, R}(x), Q_{\alpha, R}(x, y)) \in C^3(\mathbb{R}) \times C^3(\overline{\Omega}_R)$ for each $\alpha \in \mathbb{R}$.

Theorem 3.3. *Let (U_R, V_R) be the unique nontrivial nonnegative stationary solution of (3.2) obtained in Theorem 3.1 and let (u, v) be the solution of (3.2) with a nontrivial continuous initial datum (u_0, v_0) with $(0, 0) \leq (u_0, v_0) \leq (U_R, V_R)$ in $\overline{\Omega}_R$. Then there exists $c_R^* > 0$ given by*

$$c_R^* = \inf_{\alpha > 0} \frac{-\lambda_R(\alpha)}{\alpha},$$

called the asymptotic spreading speed, such that the following statements are valid:

(i) *If (u_0, v_0) is compactly supported, then for any $c > c_R^*$, there holds*

$$\lim_{t \rightarrow +\infty} \sup_{|x| \geq ct, y \in [0, R]} |(u(t, x), v(t, x, y))| = 0.$$

(ii) *For any $0 < c < c_R^*$, there holds*

$$\lim_{t \rightarrow +\infty} \sup_{|x| \leq ct, y \in [0, R]} |(u(t, x), v(t, x, y)) - (U_R(x), V_R(x, y))| = 0.$$

3. Spreading speeds and pulsating fronts for a field-road model in a periodic habitat

Before stating the result of pulsating fronts for (3.2), let us give the definition of pulsating traveling fronts in the strip $\overline{\Omega}_R$ for clarity.

Definition 3.4. A rightward pulsating front of (3.2) connecting $(U_R(x), V_R(x, y))$ to $(0, 0)$ with effective mean speed $c \in \mathbb{R}_+$ is a time-global classical solution $(u(t, x), v(t, x, y)) = (\phi_R(x - ct, x), \psi_R(x - ct, x, y))$ of (3.2) such that the following periodicity property holds:

$$u\left(t + \frac{k}{c}, x\right) = u(t, x - k), \quad v\left(t + \frac{k}{c}, x, y\right) = v(t, x - k, y) \quad \forall k \in LZ, \quad \forall t \in \mathbb{R}, \quad \forall (x, y) \in \overline{\Omega}_R. \quad (3.6)$$

Moreover, the profile $(\phi_R(s, x), \psi_R(s, x, y))$ satisfies

$$\begin{cases} \phi_R(-\infty, x) = U_R(x), \quad \phi_R(+\infty, x) = 0 \text{ uniformly in } x \in \mathbb{R}, \\ \psi_R(-\infty, x, y) = V_R(x, y), \quad \psi_R(+\infty, x, y) = 0 \text{ uniformly in } (x, y) \in \overline{\Omega}_R, \end{cases} \quad (3.7)$$

with $(\phi_R(s, x), \psi_R(s, x, y))$ being continuous in $s \in \mathbb{R}$.

Similarly, a leftward pulsating front of (3.2) connecting $(0, 0)$ to $(U_R(x), V_R(x, y))$ with effective mean speed $c \in \mathbb{R}_+$ is a time-global classical solution $(\tilde{u}(t, x), \tilde{v}(t, x, y)) = (\phi_R(x + ct, x), \psi_R(x + ct, x, y))$ of (3.2) such that the following periodicity property holds:

$$\tilde{u}\left(t + \frac{k}{c}, x\right) = \tilde{u}(t, x + k), \quad \tilde{v}\left(t + \frac{k}{c}, x, y\right) = \tilde{v}(t, x + k, y) \quad \forall k \in LZ, \quad \forall t \in \mathbb{R}, \quad \forall (x, y) \in \overline{\Omega}_R.$$

Moreover, the profile $(\phi_R(s, x), \psi_R(s, x, y))$ satisfies

$$\begin{cases} \phi_R(-\infty, x) = 0, \quad \phi_R(+\infty, x) = U_R(x) \text{ uniformly in } x \in \mathbb{R}, \\ \psi_R(-\infty, x, y) = 0, \quad \psi_R(+\infty, x, y) = V_R(x, y) \text{ uniformly in } (x, y) \in \overline{\Omega}_R, \end{cases}$$

with $(\phi_R(s, x), \psi_R(s, x, y))$ being continuous in $s \in \mathbb{R}$.

Theorem 3.5. Let c_R^* be given as in Theorem 3.3. Then the following statements are valid:

- (i) Problem (3.2) admits a rightward pulsating front connecting $(U_R(x), V_R(x, y))$ to $(0, 0)$ with wave profile $(\phi_R(s, x), \psi_R(s, x, y))$ being continuous and decreasing in s if and only if $c \geq c_R^*$.
- (ii) Problem (3.2) admits a leftward pulsating front connecting $(0, 0)$ to $(U_R(x), V_R(x, y))$ with wave profile $(\phi_R(s, x), \psi_R(s, x, y))$ being continuous and increasing in s if and only if $c \geq c_R^*$.

Theorems 3.3 and 3.5 are proved simultaneously. It is worth mentioning that, compared with the homogeneous field-road model [30] where there exists a unique minimal speed w^* along the road in the left and right directions, here we get a striking resemblance. That is,

with the spatially periodic assumption and one-dimensional setting on the road, the KPP minimal wave speeds in the right and left directions are still the same, even if there is no homogeneity in x -direction anymore. However, the asymptotic spreading speeds may differ in general, according to the direction in heterogeneous media and/or in higher dimension.

Having the principal eigenvalue $\lambda_R(\alpha)$ for eigenvalue problem (3.5) in hand, we construct in Section 3.5.1 the *generalized* principal eigenvalue $\lambda(\alpha)$ by passing to the limit $R \rightarrow +\infty$ in $\lambda_R(\alpha)$ for each $\alpha \in \mathbb{R}$, and show that there exists a positive and L -periodic (in x) solution (P_α, Q_α) of the following generalized eigenvalue problem in the half-plane:

$$\begin{cases} -DP_\alpha'' + 2D\alpha P_\alpha' + (-D\alpha^2 + \mu)P_\alpha - \nu Q_\alpha(x, 0) = \lambda(\alpha)P_\alpha, & x \in \mathbb{R}, \\ -d\Delta Q_\alpha + 2d\alpha\partial_x Q_\alpha - (d\alpha^2 + f_v(x, 0))Q_\alpha = \lambda(\alpha)Q_\alpha, & (x, y) \in \Omega, \\ -d\partial_y Q_\alpha(x, 0) + \nu Q_\alpha(x, 0) - \mu P_\alpha = 0, & x \in \mathbb{R}, \\ P_\alpha, Q_\alpha \text{ are } L\text{-periodic with respect to } x. \end{cases} \quad (3.8)$$

We call (P_α, Q_α) the generalized principal eigenfunction pair associated with $\lambda(\alpha)$.

We are now in a position to give the spreading result in the half-plane.

Theorem 3.6. *Let (u, v) be the solution of (3.1) with a nonnegative, bounded and continuous initial datum $(u_0, v_0) \not\equiv (0, 0)$. Then there exists $c^* > 0$ defined by*

$$c^* = \inf_{\alpha > 0} \frac{-\lambda(\alpha)}{\alpha},$$

called the asymptotic spreading speed, such that the following statements are valid:

(i) *If (u_0, v_0) is compactly supported, then for any $c > c^*$, for any $A > 0$,*

$$\lim_{t \rightarrow +\infty} \sup_{|x| \geq ct, 0 \leq y \leq A} |(u(t, x), v(t, x, y))| = 0.$$

(ii) *If $(u_0, v_0) < (\nu/\mu, 1)$, then, for any $0 < c < c^*$, for any $A > 0$,*

$$\lim_{t \rightarrow +\infty} \sup_{|x| \leq ct, 0 \leq y \leq A} |(u(t, x), v(t, x, y)) - (\nu/\mu, 1)| = 0. \quad (3.9)$$

In the proof of Theorem 3.6, the generalized principal eigenfunction pair (P_α, Q_α) of (3.8) associated with $\lambda(\alpha)$ will play a crucial role in getting the upper bound for the spreading result. The lower bound follows from spreading results in the truncated domain via an asymptotic method.

Next, we state the concept of pulsating fronts for problem (3.1) in the half-plane Ω .

Definition 3.7. *A rightward pulsating front of (3.1) connecting $(\nu/\mu, 1)$ and $(0, 0)$ with effective mean speed $c \in \mathbb{R}_+$ is a time-global classical solution $(u(t, x), v(t, x, y)) = (\phi(x -$*

3. Spreading speeds and pulsating fronts for a field-road model in a periodic habitat

$ct, x), \psi(x - ct, x, y))$ of (3.1) such that the following periodicity property holds:

$$u\left(t + \frac{k}{c}, x\right) = u(t, x - k), \quad v\left(t + \frac{k}{c}, x, y\right) = v(t, x - k, y) \quad \forall k \in LZ, \forall t \in \mathbb{R}, \forall (x, y) \in \bar{\Omega}.$$

Moreover, the profile $(\phi(s, x), \psi(s, x, y))$ satisfies

$$\begin{cases} \phi(-\infty, x) = \nu/\mu, \quad \phi(+\infty, x) = 0 \text{ uniformly in } x \in \mathbb{R}, \\ \psi(-\infty, x, y) = 1, \quad \psi(+\infty, x, y) = 0 \text{ uniformly in } x \in \mathbb{R}, \text{ locally uniformly in } y \in [0, +\infty), \end{cases} \quad (3.10)$$

with $(\phi(s, x), \psi(s, x, y))$ being continuous in $s \in \mathbb{R}$.

Similarly, a leftward pulsating front of (3.1) connecting $(0, 0)$ and $(\nu/\mu, 1)$ with effective mean speed $c \in \mathbb{R}_+$ is a time-global classical solution $(u(t, x), v(t, x, y)) = (\phi(x + ct, x), \psi(x + ct, x, y))$ of (3.1) such that the following periodicity property holds:

$$\tilde{u}\left(t + \frac{k}{c}, x\right) = \tilde{u}(t, x + k), \quad \tilde{v}\left(t + \frac{k}{c}, x, y\right) = \tilde{v}(t, x + k, y) \quad \forall k \in LZ, \forall t \in \mathbb{R}, \forall (x, y) \in \bar{\Omega}.$$

Moreover, the profile $(\phi(s, x), \psi(s, x, y))$ satisfies

$$\begin{cases} \phi(-\infty, x) = \nu/\mu, \quad \phi(+\infty, x) = 0 \text{ uniformly in } x \in \mathbb{R}, \\ \psi(-\infty, x, y) = 1, \quad \psi(+\infty, x, y) = 0 \text{ uniformly in } x \in \mathbb{R}, \text{ locally uniformly in } y \in [0, +\infty), \end{cases}$$

with $(\phi(s, x), \psi(s, x, y))$ being continuous in $s \in \mathbb{R}$.

Based on Theorem 3.5 and an asymptotic method, we can show:

Theorem 3.8. *Let c^* be defined as in Theorem 3.6. Then the following statements are valid:*

- (i) *Problem (3.1) admits a rightward pulsating front connecting $(\nu/\mu, 1)$ to $(0, 0)$ with wave profile $(\phi(s, x), \psi(s, x, y))$ being continuous and decreasing in s if and only if $c \geq c^*$.*
- (ii) *Problem (3.1) admits a leftward pulsating front connecting $(0, 0)$ to $(\nu/\mu, 1)$ with wave profile $(\phi(s, x), \psi(s, x, y))$ being continuous and increasing in s if and only if $c \geq c^*$.*

Outline of the paper. The remaining part of this paper is organized as follows. In Section 3.3, we state some preliminary results for problem (3.1) in the half-plane and for problem (3.2) in the strip, respectively. We prove Liouville-type results and investigate large time behaviors for problem (3.1) in Section 3.1 and for problem (3.2) in Section 3.2, respectively. Section 3.4 is dedicated to the proofs of Theorems 3.3 and 3.5. Particularly, the principal eigenvalue problem in $\bar{\Omega}_R$ is investigated, see Proposition 3.18. In Section 3.5, we give the proofs of Theorems 3.6 and 3.8, based on the study of the generalized principal eigenvalue problem and the results derived for truncated problems.

3.3 Preliminaries

In this section, we state some auxiliary results in the half-plane and in the truncated domain, respectively. Specifically, two versions of comparison principles that will be diffusely used throughout this paper and the well-posedness of the Cauchy problems for problem (3.1) in the half-line and for problem (3.2) in the strip will be given below, respectively. Since the results can be proved by slight modifications of the arguments in [30], we omit the proofs here. We also prove Liouville-type results and large time behavior of solutions to Cauchy problems (3.1) and (3.2), respectively. Finally, we investigate the limiting property of the stationary solution in the strip when the width of the strip goes to infinity.

In the sequel, a subsolution (resp. supersolution) is a couple satisfying the system in the classical sense with $=$ replaced by \leq (resp. \geq) which is continuous up to time 0. We say that a function is a generalized supersolution (resp. subsolution) if it is the minimum (resp. maximum) of a finite number of supersolutions (resp. subsolutions).

3.3.1 Preliminary results in the half-plane

Proposition 3.9. *Let $(\underline{u}, \underline{v})$ and (\bar{u}, \bar{v}) be respectively a subsolution bounded from above and a supersolution bounded from below of (3.1) satisfying $\underline{u} \leq \bar{u}$ and $\underline{v} \leq \bar{v}$ in $\bar{\Omega}$ at $t = 0$. Then, either $\underline{u} < \bar{u}$ and $\underline{v} < \bar{v}$ in $\bar{\Omega}$ for all $t > 0$, or there exists $T > 0$ such that $(\underline{u}, \underline{v}) = (\bar{u}, \bar{v})$ in $\bar{\Omega}$ for $t \leq T$.*

Proposition 3.10. *Let $E \subset (0, +\infty) \times \mathbb{R}$ and $F \subset (0, +\infty) \times \Omega$ be two open sets and let (u_1, v_1) and (u_2, v_2) be two subsolutions of (3.1) bounded from above, satisfying*

$$u_1 \leq u_2 \text{ on } (\partial E) \cap ((0, +\infty) \times \mathbb{R}), \quad v_1 \leq v_2 \text{ on } (\partial F) \cap ((0, +\infty) \times \Omega).$$

If the functions $\underline{u}, \underline{v}$ defined by

$$\underline{u}(t, x) := \begin{cases} \max\{u_1(t, x), u_2(t, x)\} & \text{if } (t, x) \in \bar{E} \\ u_2(t, x) & \text{otherwise} \end{cases}$$

$$\underline{v}(t, x, y) := \begin{cases} \max\{v_1(t, x, y), v_2(t, x, y)\} & \text{if } (t, x, y) \in \bar{F} \\ v_2(t, x, y) & \text{otherwise} \end{cases}$$

satisfy

$$\underline{u}(t, x) > u_2(t, x) \Rightarrow \underline{v}(t, x, 0) \geq v_1(t, x, 0),$$

$$\underline{v}(t, x, 0) > v_2(t, x, 0) \Rightarrow \underline{u}(t, x) \geq u_1(t, x),$$

then, any supersolution (\bar{u}, \bar{v}) of (3.1) bounded from below and such that $\underline{u} \leq \bar{u}$ and $\underline{v} \leq \bar{v}$ in

3. Spreading speeds and pulsating fronts for a field-road model in a periodic habitat

$\bar{\Omega}$ at $t = 0$, satisfies $\underline{u} \leq \bar{u}$ and $\underline{v} \leq \bar{v}$ in $\bar{\Omega}$ for all $t > 0$.

Proposition 3.11. *The Cauchy problem (3.1) with nonnegative, bounded and continuous initial datum $(u_0, v_0) \not\equiv (0, 0)$ admits a unique nonnegative classical bounded solution (u, v) for $t \geq 0$ and $(x, y) \in \bar{\Omega}$.*

Now we prove a Liouville-type result for the stationary problem corresponding to (3.1) as well as the long time behavior of solutions for the Cauchy problem (3.1).

Theorem 3.12. *Problem (3.1) has a unique positive bounded stationary solution $(U, V) \equiv (\nu/\mu, 1)$. Moreover, let (u, v) be the solution of (3.1) with a nonnegative, bounded and continuous initial datum $(u_0, v_0) \not\equiv (0, 0)$, then*

$$\lim_{t \rightarrow +\infty} (u(t, x), v(t, x, y)) = (\nu/\mu, 1) \quad \text{locally uniformly for } (x, y) \in \bar{\Omega}. \quad (3.11)$$

Proof. Let (u, v) be the solution, given in Proposition 3.11, of the Cauchy problem (3.1) starting from a nonnegative, bounded and continuous initial datum $(u_0, v_0) \not\equiv (0, 0)$. We first show the existence of the nontrivial nonnegative and bounded stationary solution of (3.1), by using a sub- and supersolution argument. Take $\rho > 0$ large enough such that the principal eigenvalue of $-\Delta$ in $B_\rho \subset \mathbb{R}^2$ with Dirichlet boundary condition is less than $m/(2d)$ (recall that $m = \min_{[0, L]} f_v(x, 0) > 0$). Then, the associated principal eigenfunction φ_ρ satisfies $-d\Delta\varphi_\rho \leq m\varphi_\rho/2$ in B_ρ . Hence, there exists $\varepsilon_0 > 0$ such that the function $\varepsilon\varphi_\rho$ satisfies $-d\Delta(\varepsilon\varphi_\rho) \leq f(x, \varepsilon\varphi_\rho)$ in B_ρ for all $\varepsilon \in (0, \varepsilon_0]$. Define $\underline{V}(x, y) = \varepsilon\varphi_\rho(x, y - \rho - 1)$ in $B_\rho(0, \rho + 1)$ and extend it by 0 outside. The function pair $(0, \underline{V})$ is nonnegative, bounded and continuous. On the other hand, Proposition 6.25 implies that (u, v) is positive for $t > 0$ and $(x, y) \in \bar{\Omega}$. Hence, up to decreasing ε if necessary, we have that $(0, \underline{V})$ is below $(u(1, \cdot), v(1, \cdot, \cdot))$ in $\bar{\Omega}$. Let $(\underline{u}, \underline{v})$ be the unique bounded classical solution of (3.1) with initial condition $(0, \underline{V})$. It then follows from Proposition 3.10 that $(\underline{u}, \underline{v})$ is increasing in t and $(\underline{u}(t, x), \underline{v}(t, x, y)) < (u(t + 1, x), v(t + 1, x, y))$ for $t > 0$ and $(x, y) \in \bar{\Omega}$. By parabolic estimates, $(\underline{u}, \underline{v})$ converges locally uniformly in $\bar{\Omega}$ as $t \rightarrow +\infty$ to a stationary solution (U_1, V_1) of (3.1) satisfying

$$0 < U_1 \leq \liminf_{t \rightarrow +\infty} u(t, x), \quad \underline{V} < V_1 \leq \liminf_{t \rightarrow +\infty} v(t, x, y). \quad (3.12)$$

On the other hand, define

$$(\bar{U}, \bar{V}) := \max \left\{ \frac{\|u_0\|_{L^\infty(\mathbb{R})}}{\nu}, \frac{\|v_0\|_{L^\infty(\bar{\Omega})} + 1}{\mu} \right\} (\nu, \mu). \quad (3.13)$$

Obviously, (\bar{U}, \bar{V}) is a supersolution of (3.1) and satisfies $(\bar{U}, \bar{V}) \geq (u_0, v_0)$. Let (\bar{u}, \bar{v}) be the solution of (3.1) with initial datum (\bar{U}, \bar{V}) , then Proposition 6.25 implies that (\bar{u}, \bar{v}) is

non-increasing in t . From parabolic estimates, (\bar{u}, \bar{v}) converges locally uniformly in $\bar{\Omega}$ as $t \rightarrow +\infty$ to a stationary solution (U_2, V_2) of (3.1) satisfying

$$\limsup_{t \rightarrow +\infty} u(t, x) \leq U_2 \leq \bar{U}, \quad \limsup_{t \rightarrow +\infty} v(t, x, y) \leq V_2 \leq \bar{V}. \quad (3.14)$$

Therefore, the existence of nontrivial nonnegative and bounded stationary solutions of (3.1) is proved.

Let (U, V) be an arbitrary nontrivial nonnegative and bounded stationary solution of (3.1). In the spirit of [30, Proposition 4.1] and [84, Lemma 2.5], one can further conclude that $\inf_{\bar{\Omega}} V > 0$ and then $\inf_{\mathbb{R}} U > 0$, by using the hypothesis $m := \min_{[0, L]} f_v(x, 0) > 0$.

Next, we show the uniqueness. Assume that (U_1, V_1) and (U_2, V_2) are two distinct positive bounded stationary solutions of (3.1). Then, there is $\varepsilon > 0$ such that $U_i \geq \varepsilon$ in \mathbb{R} and $V_i \geq \varepsilon$ in $\bar{\Omega}$ for $i = 1, 2$. Therefore, we can define

$$\theta^* := \sup \{ \theta > 0 : (U_1, V_1) > \theta(U_2, V_2) \text{ in } \bar{\Omega} \} > 0.$$

Assume that $\theta^* < 1$. Set $P := U_1 - \theta^*U_2 \geq 0$ in \mathbb{R} and $Q := V_1 - \theta^*V_2 \geq 0$ in $\bar{\Omega}$. From the definition of θ^* , there exists a sequence $(x_n, y_n)_{n \in \mathbb{N}}$ in $\bar{\Omega}$ such that $P(x_n) \rightarrow 0$, or $Q(x_n, y_n) \rightarrow 0$ as $n \rightarrow +\infty$.

Assume that the second case occurs, we claim that $(y_n)_{n \in \mathbb{N}}$ is bounded. Assume by contradiction that $y_n \rightarrow +\infty$ as $n \rightarrow +\infty$, then, up to extraction of a subsequence, the functions $V_{i,n}(x, y) := V_i(x, y + y_n)$ ($i = 1, 2$) converge locally uniformly to positive bounded functions $V_{i,\infty}$ solving $-d\Delta V_{i,\infty} = f(x, V_{i,\infty})$ in \mathbb{R}^2 , which implies that $V_{i,\infty} \equiv 1$ in \mathbb{R}^2 , because of the KPP hypothesis on f . Then, it follows that $Q(x_n, y_n) \rightarrow 1 - \theta^* > 0$ as $n \rightarrow +\infty$, which is a contradiction. Thus, the sequence $(y_n)_{n \in \mathbb{N}}$ must be bounded. We then distinguish two subcases.

Assume that, up to a subsequence, $x_n \rightarrow \bar{x} \in \mathbb{R}$ and $y_n \rightarrow \bar{y} \in [0, +\infty)$ as $n \rightarrow +\infty$. By continuity, one has $Q \geq 0$ in $\bar{\Omega}$ and $Q(\bar{x}, \bar{y}) = 0$. Suppose that $\bar{y} > 0$. Notice that Q satisfies

$$-d\Delta Q = f(x, V_1) - \theta^* f(x, V_2) \text{ in } \Omega, \quad (3.15)$$

Since $f(x, v)/v$ is decreasing in $v > 0$ for all $x \in \mathbb{R}$ and since $\theta^* < 1$, it follows that $-d\Delta Q > f(x, V_1) - f(x, \theta^*V_2)$ in Ω . Since f is locally Lipschitz continuous in the second variable, there exists a bounded function $b(x, y)$ defined in Ω such that

$$-d\Delta Q + bQ > 0 \text{ in } \Omega. \quad (3.16)$$

Since $Q \geq 0$ in $\bar{\Omega}$ and $Q(\bar{x}, \bar{y}) = 0$, it follows from the strong maximum principle that $Q \equiv 0$ in Ω , which contradicts the strict inequality in (3.16). Hence, $Q > 0$ in Ω . Suppose now that $\bar{y} = 0$, then $Q(\bar{x}, 0) = 0$. The Hopf lemma implies that $\partial_y Q(\bar{x}, 0) > 0$. Using the

3. Spreading speeds and pulsating fronts for a field-road model in a periodic habitat

boundary condition, one gets $0 > -d\partial_y Q(\bar{x}, 0) = \mu P(\bar{x}) - \nu Q(\bar{x}, 0) = \mu P(\bar{x}) \geq 0$. This is a contradiction. Therefore, $Q > 0$ in $\bar{\Omega}$.

In the general case, let $\bar{x}_n \in [0, L]$ be such that $x_n - \bar{x}_n \in L\mathbb{Z}$, then up to extraction of a subsequence, $\bar{x}_n \rightarrow \bar{x}_\infty \in [0, L]$ as $n \rightarrow \infty$. Since y_n are bounded, up to extraction of a further subsequence, one gets $y_n \rightarrow \bar{y}_\infty \in [0, +\infty)$ as $n \rightarrow +\infty$. Let us set $U_{i,n}(x) := U_i(x + x_n)$ and $V_{i,n}(x, y) := V_i(x + x_n, y + y_n)$ for $i = 1, 2$. Then, $(U_{i,n}, V_{i,n})$ satisfies

$$\begin{cases} -DU_{i,n}'' = \nu V_{i,n}(x, 0) - \mu U_{i,n} & \text{in } \mathbb{R}, \\ -d\Delta V_{i,n} = f(x + \bar{x}_n, V_{i,n}) & \text{in } \Omega, \\ -d\partial_y V_{i,n}(x, 0) = \mu U_{i,n} - \nu V_{i,n}(x, 0) & \text{in } \mathbb{R}. \end{cases} \quad (3.17)$$

From standard elliptic estimates, it follows that, up to a subsequence, $(U_{i,n}, V_{i,n})$ converges locally uniformly as $n \rightarrow +\infty$ to a classical solution $(U_{i,\infty}, V_{i,\infty})$ of

$$\begin{cases} -DU_{i,\infty}'' = \nu V_{i,\infty}(x, 0) - \mu U_{i,\infty} & \text{in } \mathbb{R}, \\ -d\Delta V_{i,\infty} = f(x + \bar{x}_\infty, V_{i,\infty}) & \text{in } \Omega, \\ -d\partial_y V_{i,\infty}(x, 0) = \mu U_{i,\infty} - \nu V_{i,\infty}(x, 0) & \text{in } \mathbb{R}. \end{cases} \quad (3.18)$$

Moreover, there is $\varepsilon > 0$ such that $U_{i,\infty} \geq \varepsilon$ in \mathbb{R} and $V_{i,\infty} \geq \varepsilon$ in $\bar{\Omega}$.

Set $P_\infty := U_{1,\infty} - \theta^* U_{2,\infty}$ in \mathbb{R} , and $Q_\infty := V_{1,\infty} - \theta^* V_{2,\infty}$ in $\bar{\Omega}$. Then, $P_\infty \geq 0$ in \mathbb{R} , $Q_\infty \geq 0$ in $\bar{\Omega}$ and $Q_\infty(\bar{x}_\infty, \bar{y}_\infty) = 0$. Suppose that $\bar{y}_\infty > 0$. Notice that Q_∞ satisfies

$$-d\Delta Q_\infty = f(x + \bar{x}_\infty, V_{1,\infty}) - \theta^* f(x + \bar{x}_\infty, V_{2,\infty}) \text{ in } \Omega.$$

By analogy with the analysis for problem (3.15), one eventually obtains that $Q_\infty > 0$ in Ω . One can exclude the case that $\bar{y}_\infty = 0$, by using again the Hopf lemma and the boundary condition. Therefore, $Q_\infty > 0$ in $\bar{\Omega}$. Thus, the case that $Q(x_n, y_n) \rightarrow 0$ is ruled out.

It is left to discuss the first case that $P(x_n) \rightarrow 0$ as $n \rightarrow +\infty$. Assume first that, up to a subsequence, $x_n \rightarrow \bar{x}$ as $n \rightarrow +\infty$. By continuity, one has $P \geq 0$ in \mathbb{R} and $P(\bar{x}) = 0$. Moreover, P satisfies $-DP'' + \mu P = \nu Q(\cdot, 0) > 0$ in \mathbb{R} . The strong maximum principle implies that $P \equiv 0$ in \mathbb{R} , which is a contradiction. In the general case, let $\bar{x}_n \in [0, L]$ be such that $x_n - \bar{x}_n \in L\mathbb{Z}$, then up to a subsequence, $\bar{x}_n \rightarrow \bar{x}_\infty \in [0, L]$ as $n \rightarrow \infty$. Set $U_{i,n}(x) := U_i(x + x_n)$ in \mathbb{R} and $V_{i,n}(x, y) := V_i(x + x_n, y)$ in $\bar{\Omega}$, for $i = 1, 2$. Then $(U_{i,n}, V_{i,n})$ satisfies (3.17) in $\bar{\Omega}$. From standard elliptic estimates, it follows that, up to a subsequence, $U_{i,n}$ and $V_{i,n}$ converge as $n \rightarrow +\infty$ in C_{loc}^2 to $U_{i,\infty}$ and $V_{i,\infty}$, respectively, which satisfy (3.18). Set $P_\infty := U_{1,\infty} - \theta^* U_{2,\infty}$ in \mathbb{R} and $Q_\infty := V_{1,\infty} - \theta^* V_{2,\infty}$ in $\bar{\Omega}$. Then, $P_\infty \geq 0$ in \mathbb{R} and $P_\infty(0) = 0$, $Q_\infty > 0$ in $\bar{\Omega}$. Moreover, it holds

$$-DP_\infty'' + \mu P_\infty = \nu Q_\infty(\cdot, 0) > 0 \text{ in } \mathbb{R}.$$

The strong maximum principle then implies that $P_\infty \equiv 0$ in \mathbb{R} , which is a contradiction. Hence, the case that $P(x_n) \rightarrow 0$ is also impossible.

Consequently, $\theta^* \geq 1$, whence $(U_1, V_1) \geq (U_2, V_2)$ in $\bar{\Omega}$. By interchanging the roles of (U_1, V_1) and (U_2, V_2) , one can show that $(U_2, V_2) \geq (U_1, V_1)$ in $\bar{\Omega}$. The uniqueness is achieved.

Furthermore, if (U, V) is a positive bounded stationary solution of (3.1), it is easy to check that any L -lattice translation in x of (U, V) is still a positive bounded stationary solution of (3.1). Thus, (U, V) is L -periodic in x . It is straightforward to check that $(\nu/\mu, 1)$ satisfies the stationary problem of (3.1). Therefore, $(\nu/\mu, 1)$ is the unique positive and bounded stationary solution of (3.1). The large time behavior (3.11) of the solution to the Cauchy problem (3.1) then follows immediately from (3.12) and (3.14). The proof of Theorem 3.12 is thereby complete. \square

3.3.2 Preliminary results in the strip

Proposition 3.13. *Let $(\underline{u}, \underline{v})$ and (\bar{u}, \bar{v}) be respectively a subsolution bounded from above and a supersolution bounded from below of (3.2) satisfying $\underline{u} \leq \bar{u}$ and $\underline{v} \leq \bar{v}$ in $\bar{\Omega}_R$ at $t = 0$. Then, either $\underline{u} < \bar{u}$ and $\underline{v} < \bar{v}$ in $\mathbb{R} \times [0, R)$ and $\partial_y \bar{v}(t, x, R) < \partial_y \underline{v}(t, x, R)$ on \mathbb{R} for all $t > 0$, or there exists $T > 0$ such that $(\underline{u}, \underline{v}) = (\bar{u}, \bar{v})$ in $\bar{\Omega}_R$ for $t \leq T$.*

Proposition 3.14. *Let $E \subset (0, +\infty) \times \mathbb{R}$ and $F \subset (0, +\infty) \times \Omega_R$ be two open sets and let (u_1, v_1) and (u_2, v_2) be two subsolutions of (3.2) bounded from above, satisfying*

$$u_1 \leq u_2 \text{ on } (\partial E) \cap ((0, +\infty) \times \mathbb{R}), \quad v_1 \leq v_2 \text{ on } (\partial F) \cap ((0, +\infty) \times \Omega_R).$$

If the functions $\underline{u}, \underline{v}$ defined by

$$\underline{u}(t, x) := \begin{cases} \max\{u_1(t, x), u_2(t, x)\} & \text{if } (t, x) \in \bar{E} \\ u_2(t, x) & \text{otherwise} \end{cases}$$

$$\underline{v}(t, x, y) := \begin{cases} \max\{v_1(t, x, y), v_2(t, x, y)\} & \text{if } (t, x, y) \in \bar{F} \\ v_2(t, x, y) & \text{otherwise} \end{cases}$$

satisfy

$$\underline{u}(t, x) > u_2(t, x) \Rightarrow \underline{v}(t, x, 0) \geq v_1(t, x, 0),$$

$$\underline{v}(t, x, 0) > v_2(t, x, 0) \Rightarrow \underline{u}(t, x) \geq u_1(t, x),$$

then, any supersolution (\bar{u}, \bar{v}) of (3.2) bounded from below and such that $\underline{u} \leq \bar{u}$ and $\underline{v} \leq \bar{v}$ in $\bar{\Omega}_R$ at $t = 0$, satisfies $\underline{u} \leq \bar{u}$ and $\underline{v} \leq \bar{v}$ in $\bar{\Omega}_R$ for all $t > 0$.

Proposition 3.15. *The Cauchy problem (3.2) with nonnegative, bounded and continuous initial datum $(u_0, v_0) \not\equiv (0, 0)$ admits a unique bounded classical solution (u, v) for all $t \geq 0$*

3. Spreading speeds and pulsating fronts for a field-road model in a periodic habitat

and $(x, y) \in \overline{\Omega}_R$. Moreover, for any $0 < \tau < T$ and for any compact subsets $I \subset \mathbb{R}$ and $H \subset \Omega_R$ with $\overline{H} \cap \{y = 0\} = \overline{I}$,

$$\|u(t, x)\|_{C^{1+\frac{\alpha}{2}, 2+\alpha}([\tau, T] \times \overline{I})} + \|v(t, x, y)\|_{C^{1+\frac{\alpha}{2}, 2+\alpha}([\tau, T] \times \overline{H})} \leq C,$$

where C is a positive constant depending on $\tau, T, f, \|u_0\|_{L^\infty(\mathbb{R})}$ and $\|v_0\|_{L^\infty(\overline{\Omega}_R)}$.

The existence of the solution to the Cauchy problem (3.2) follows from an approximation argument by constructing a sequence of approximate solutions in $[-n, n] \times [0, R]$ for n large enough, which satisfy²

$$\begin{cases} \partial_t u - D\partial_{xx}u = \nu v(t, x, 0) - \mu u, & t > 0, x \in [-n, n], \\ \partial_t v - d\Delta v = f(x, v), & t > 0, (x, y) \in (-n, n) \times (0, R), \\ -d\partial_y v(t, x, 0) = \mu u - \nu v(t, x, 0), & t > 0, x \in [-n, n], \\ v(t, x, R) = 0, & t > 0, x \in [-n, n], \\ v(t, \pm n, y) = 0, & t > 0, y \in [0, R], \end{cases} \quad (3.19)$$

and then passing to the limit $n \rightarrow +\infty$ via the Arzelà-Ascoli theorem. Uniqueness comes from the comparison principle Proposition 3.13. The estimate can be derived by standard parabolic L^p theory (see, e.g., [112, page 168, Proposition 7.14]) and then the Schauder theory.

In the following, we show the continuous dependence of the solutions to the Cauchy problem (3.2) on initial data.

Proposition 3.16. *The solutions of the Cauchy problem (3.2) depend continuously on the initial data.*

Proof. Let (u, v) be the solution, given in Proposition 3.15, of (3.2) with nonnegative, bounded and continuous initial datum $(u_0, v_0) \not\equiv (0, 0)$. We shall prove that for any $\varepsilon > 0$, $T > 0$, there is $\delta > 0$, depending on ε, T and (u_0, v_0) , such that for any nonnegative, bounded and continuous function pair $(\tilde{u}_0, \tilde{v}_0)$ satisfying

$$\sup_{x \in \mathbb{R}} |u_0(x) - \tilde{u}_0(x)| < \frac{\nu}{\mu} \delta, \quad \sup_{(x, y) \in \overline{\Omega}_R} |v_0(x, y) - \tilde{v}_0(x, y)| < \delta, \quad (3.20)$$

the solution to (3.2) with initial value $(\tilde{u}_0, \tilde{v}_0)$ satisfies

$$\sup_{(t, x) \in [0, T] \times \mathbb{R}} |u(t, x) - \tilde{u}(t, x)| < \frac{\nu}{\mu} \varepsilon, \quad \sup_{(t, x, y) \in [0, T] \times \overline{\Omega}_R} |v(t, x, y) - \tilde{v}(t, x, y)| < \varepsilon. \quad (3.21)$$

²Problem (3.19) with a nonnegative, continuous and bounded initial function has a unique bounded classical solution defined for all $t > 0$, which can be obtained in the spirit of Appendix A in [30] and the strong maximum principle.

Recall that $M = \max_{[0,L]} f_v(x, 0)$. Define $(w, z) := (u, v)e^{-Mt}$, then (w, z) satisfies

$$\begin{cases} \partial_t w - D\partial_{xx} w = \nu z(t, x, 0) - (\mu + M)w, & t > 0, x \in \mathbb{R}, \\ \partial_t z - d\Delta z = g(t, x, z), & t > 0, (x, y) \in \Omega_R, \\ -d\partial_y z(t, x, 0) = \mu w - \nu z(t, x, 0), & t > 0, x \in \mathbb{R}, \\ z(t, x, R) = 0, & t > 0, x \in \mathbb{R}, \end{cases} \quad (3.22)$$

where the function $g(t, x, z) := f(x, e^{Mt}z)e^{-Mt} - Mz$ is non-increasing in z . We observe that $(u, v)e^{-Mt}$ and $(\tilde{u}, \tilde{v})e^{-Mt}$ are the solutions of (3.22) with initial functions (u_0, v_0) and $(\tilde{u}_0, \tilde{v}_0)$, respectively.

Define

$$\begin{cases} \underline{u}(t, x) := \max\left(0, w(t, x) - \frac{\nu}{\mu}\delta\left(\frac{t}{T} + 1\right)\right), \\ \underline{v}(t, x, y) := \max\left(0, z(t, x, y) - \delta\left(\frac{t}{T} + 1\right)\right), \end{cases}$$

and

$$\begin{cases} \bar{u}(t, x) := \min\left(\frac{\nu}{\mu+M}A, w(t, x) + \frac{\nu}{\mu}\delta\left(\frac{t}{T} + 1\right)\right), \\ \bar{v}(t, x, y) := \min\left(A, z(t, x, y) + \delta\left(\frac{t}{T} + 1\right)\right), \end{cases}$$

where $A := \max\left(1, \|u_0\|_{L^\infty(\mathbb{R})} + \|v_0\|_{L^\infty(\bar{\Omega}_R)} + \delta, \frac{\mu+M}{\nu}(\|u_0\|_{L^\infty(\mathbb{R})} + \|v_0\|_{L^\infty(\bar{\Omega}_R)} + \frac{\nu}{\mu}\delta)\right)$. It can be checked that $(\underline{u}, \underline{v})$ and (\bar{u}, \bar{v}) are, respectively, a generalized sub- and a generalized supersolution of (3.22). Notice that

$$\begin{aligned} \underline{u}(0, x) &= \max\left(0, u_0(x) - \frac{\nu}{\mu}\delta\right) < u_0(x) < u_0(x) + \frac{\nu}{\mu}\delta = \bar{u}(0, x), \quad \forall x \in \mathbb{R}, \\ \underline{v}(0, x, y) &= \max\left(0, v_0(x, y) - \delta\right) < v_0(x, y) < v_0(x, y) + \delta = \bar{v}(0, x, y), \quad \forall (x, y) \in \bar{\Omega}_R. \end{aligned}$$

From (6.44), one infers that

$$\begin{aligned} \underline{u}(0, x) &= \max\left(0, u_0(x) - \frac{\nu}{\mu}\delta\right) < \tilde{u}_0(x) < u_0(x) + \frac{\nu}{\mu}\delta = \bar{u}(0, x), \quad \forall x \in \mathbb{R}, \\ \underline{v}(0, x, y) &= \max\left(0, v_0(x, y) - \delta\right) < \tilde{v}_0(x, y) < v_0(x, y) + \delta = \bar{v}(0, x, y), \quad \forall (x, y) \in \bar{\Omega}_R. \end{aligned}$$

By a comparison argument, it follows that

$$(\underline{u}, \underline{v}) \leq (u, v)e^{-Mt} \leq (\bar{u}, \bar{v}), \quad (\underline{u}, \underline{v}) \leq (\tilde{u}, \tilde{v})e^{-Mt} \leq (\bar{u}, \bar{v}),$$

for all $t \in [0, T]$ and $(x, y) \in \bar{\Omega}_R$. Thus,

$$\sup_{[0, T] \times \mathbb{R}} |u(t, x) - \tilde{u}(t, x)| \leq e^{MT} \sup_{[0, T] \times \mathbb{R}} |\bar{u}(t, x) - \underline{u}(t, x)| \leq 2e^{MT} \frac{\nu}{\mu} \delta \sup_{[0, T]} \left(\frac{t}{T} + 1\right) \leq 4e^{MT} \frac{\nu}{\mu} \delta,$$

3. Spreading speeds and pulsating fronts for a field-road model in a periodic habitat

$$\sup_{[0,T] \times \bar{\Omega}_R} |v(t, x, y) - \tilde{v}(t, x, y)| \leq e^{MT} \sup_{[0,T] \times \bar{\Omega}_R} |\bar{v}(t, x, y) - \underline{v}(t, x, y)| \leq 2e^{MT} \delta \sup_{[0,T]} \left(\frac{t}{T} + 1\right) \leq 4e^{MT} \delta.$$

By choosing $\delta > 0$ so small that $4e^{MT} \delta < \varepsilon$, (3.21) is therefore achieved. \square

Next, we prove a Liouville-type result in the strip, provided that the width R is sufficiently large. Namely, for all R large, problem (3.2) admits a unique nonnegative nontrivial stationary solution (U_R, V_R) , which is L -periodic in x . Moreover, we show that (U_R, V_R) is the global attractor for solutions of the Cauchy problem in the strip.

Proof of Theorem 3.1. The strategy of this proof is similar in spirit to that of Theorem 3.12. We only sketch the proof of the existence and positivity property of stationary solutions, for which the construction of subsolutions is inspired by [152, Proposition 3.4].

Let (u, v) be the solution to the Cauchy problem (3.2) with nonnegative, bounded and continuous initial value $(u_0, v_0) \not\equiv (0, 0)$. Set

$$(\underline{u}, \underline{v}) := \begin{cases} \cos(\omega x) \left(1, \frac{\mu \sin(\beta(R-y))}{d\beta \cos(\beta R) + \nu \sin(\beta R)}\right) & \text{for } (x, y) \in \left(-\frac{\pi}{2\omega}, \frac{\pi}{2\omega}\right) \times [0, R], \\ (0, 0) & \text{otherwise,} \end{cases}$$

where ω and β are parameters to be chosen later so that $(\underline{u}, \underline{v})$ satisfies

$$\begin{cases} -D\underline{u}'' \leq \nu \underline{v}(x, 0) - \mu \underline{u}, & x \in \mathbb{R}, \\ -d\Delta \underline{v} \leq (m - \delta) \underline{v}, & (x, y) \in \Omega_R, \\ -d\partial_y \underline{v}(x, 0) = \mu \underline{u} - \nu \underline{v}(x, 0), & x \in \mathbb{R}, \\ \underline{v}(x, R) = 0, & x \in \mathbb{R}, \end{cases} \quad (3.23)$$

where $\delta > 0$ is small enough such that $0 < \delta < m = \min_{[0,L]} f_v(x, 0)$. A lengthy but straightforward calculation reveals, from the first two relations of (3.23), that ω and β should verify

$$\begin{cases} D\omega^2 \leq -\frac{\mu d \beta \cos(\beta R)}{d\beta \cos(\beta R) + \nu \sin(\beta R)}, \\ d\omega^2 + d\beta^2 \leq m - \delta. \end{cases}$$

Because of (3.3), $\delta > 0$ can be chosen sufficiently small such that $d\left(\frac{\pi}{2R}\right)^2 < m - \delta$. Then, β can be chosen very closely to $\frac{\pi}{2R}$, say $\beta \sim \frac{\pi}{2R}$ and $\frac{\pi}{2R} < \beta < \frac{\pi}{R}$, such that

$$\kappa := \min \left\{ -\frac{\mu d \beta \cos(\beta R)}{D(d\beta \cos(\beta R) + \nu \sin(\beta R))}, \frac{m - \delta}{d} - \beta^2 \right\} > 0.$$

Therefore, $(\underline{u}, \underline{v})$ satisfies (3.23), provided $\omega^2 \leq \kappa$. On the other hand, $u(t, x) > 0$ and $v(t, x, y) > 0$ for all $t > 0$ and $(x, y) \in \mathbb{R} \times [0, R]$, and $\partial_y v(t, x, R) < 0$ for all $t > 0$ and $x \in \mathbb{R}$, which is a direct consequence of Proposition 3.13 and the Hopf lemma. Hence, there

is $\varepsilon_0 > 0$ such that $\varepsilon(\underline{u}, \underline{v}) \leq (u(1, \cdot), v(1, \cdot, \cdot))$ in $\overline{\Omega}_R$ for all $\varepsilon \in (0, \varepsilon_0]$. It then follows from the same lines as in Theorem 3.12 that there is a nontrivial steady state (U_1, V_1) of (3.2) such that

$$\varepsilon \underline{u} \leq U_1 \leq \liminf_{t \rightarrow +\infty} u(t, x), \quad \varepsilon \underline{v} \leq V_1 \leq \liminf_{t \rightarrow +\infty} v(t, x, y), \quad (3.24)$$

locally uniformly in $\overline{\Omega}_R$, thanks to Proposition 3.14. On the other hand, by choosing $(\overline{U}, \overline{V})$ as in (3.13) and by using the same argument as in Theorem 3.12, it comes that there is a stationary solution (U_2, V_2) of (3.2) satisfying

$$\limsup_{t \rightarrow +\infty} u(t, x) \leq U_2 \leq \overline{U}, \quad \limsup_{t \rightarrow +\infty} v(t, x, y) \leq V_2 \leq \overline{V}, \quad (3.25)$$

locally uniformly in $\overline{\Omega}_R$. Therefore, the existence part is proved.

Moreover, let (U, V) be a nonnegative bounded stationary solution of (3.2). From the analysis above and from the elliptic strong maximum principle, one also deduces that, for any given $\hat{x} \in \mathbb{R}$, for $\forall(x, y) \in (\hat{x} - \frac{\pi}{2\omega}, \hat{x} + \frac{\pi}{2\omega}) \times [0, R)$,

$$U(x) > \varepsilon \cos(\omega(x - \hat{x})) > 0, \quad V(x, y) > \varepsilon \cos(\omega(x - \hat{x})) \frac{\mu \sin(\beta(R - y))}{d\beta \cos(\beta R) + \nu \sin(\beta R)} > 0, \quad \text{for all } \varepsilon \in (0, \varepsilon_0],$$

which implies $\inf_{\mathbb{R}} U > 0$ and $\inf_{\mathbb{R} \times [0, R)} V > 0$. Then, by repeating the uniqueness argument in the proof of Theorem 3.12 and by (3.24)–(3.25), the conclusion in Theorem 3.1 follows. \square

In the sequel, we show the limiting behavior of the steady state (U_R, V_R) of (3.2) as R goes to infinity, which will play a crucial role in obtaining the existence of pulsating fronts in the half-plane Ω in Section 3.5.

Proposition 3.17. *The stationary solution (U_R, V_R) of (3.2) satisfies the following properties:*

- (i) $0 < U_R < \nu/\mu$ in \mathbb{R} , $0 < V_R < 1$ in $\mathbb{R} \times [0, R)$;
- (ii) the limiting property holds:

$$(U_R(x), V_R(x, y)) \rightarrow (\nu/\mu, 1) \quad \text{as } R \rightarrow +\infty \quad (3.26)$$

uniformly in $x \in \mathbb{R}$ and locally uniformly in $y \in [0, +\infty)$.

Proof. (i) From the proof of Theorem 3.1, it is seen that $U_R > 0$ in \mathbb{R} and $V_R > 0$ in $\mathbb{R} \times [0, R)$. Notice also that $(\nu/\mu, 1)$ is obviously a strict stationary supersolution of (3.2). Let $(\overline{u}, \overline{v})$ be the unique bounded classical solution of (3.2) with initial condition $(\nu/\mu, 1)$. It follows from Proposition 3.13 that $(\overline{u}, \overline{v})$ is decreasing in t . Since $(\overline{u}(t, \cdot), \overline{v}(t, \cdot, \cdot))$ converges to (U_R, V_R) as $t \rightarrow +\infty$ locally uniformly in $\overline{\Omega}_R$ by Theorem 3.1, one has $\overline{u}(t, x) > U_R(x)$ and $\overline{v}(t, x, y) > V_R(x, y)$ for all $t \geq 0$ and $(x, y) \in \mathbb{R} \times [0, +\infty)$. Therefore, $U_R < \nu/\mu$ in \mathbb{R} and $V_R < 1$ in $\mathbb{R} \times [0, +\infty)$. The statement (i) is then proved.

3. Spreading speeds and pulsating fronts for a field-road model in a periodic habitat

(ii) Now, let us turn to show the limiting property. First, we claim that (U_R, V_R) is increasing in R . To prove this, we fix $R_1 < R_2$. Denote by $\Omega_i := \Omega_{R_i}$ ($i = 1, 2$) and by $(U_i, V_i) := (U_{R_i}, V_{R_i})$ ($i = 1, 2$) the unique nontrivial stationary solutions of (3.2) in $\bar{\Omega}_i$ ($i = 1, 2$), respectively. One can prove that $U_1 < U_2$ in \mathbb{R} and $V_1 < V_2$ in $\mathbb{R} \times [0, R_1)$, by noticing that (U_2, V_2) is a strict stationary supersolution of (3.2) in Ω_1 and by a similar argument as in (i). Our claim is thereby proved. Due to the boundedness of (U_R, V_R) in (i), it follows from the monotone convergence theorem and standard elliptic estimates that (U_R, V_R) converges as $R \rightarrow +\infty$ locally uniformly in $\bar{\Omega}$ to a classical solution (U, V) of the following stationary problem:

$$\begin{cases} -D\partial_{xx}U = \nu V(x, 0) - \mu U, & x \in \mathbb{R}, \\ -d\Delta V = f(x, V), & (x, y) \in \Omega, \\ -d\partial_y V(x, 0) = \mu U(x) - \nu V(x, 0), & x \in \mathbb{R}. \end{cases}$$

Owing to Theorem 3.12, it follows that $(U, V) = (\nu/\mu, 1)$. Thus, (3.26) is proved. \square

3.4 Propagation properties in the strip: Proofs of Theorems 3.3 and 3.5

This section is dedicated to the existence of the asymptotic spreading speed c_R^* and its coincidence with the minimal wave speed for pulsating fronts for truncated problem (3.2) along the road. In particular, we will give a variational formula for c_R^* by using the principal eigenvalue for certain linear eigenvalue problem. As will be shown below, the discussion combines the dynamical system approach for monostable evolution problems developed in [114] with PDE's method.

Let $D := [0, L] \times [0, R]$ and define the Banach spaces

$$X = \{(u, v) \in C([0, L]) \times C(D) : v(\cdot, R) = 0 \text{ in } [0, L]\}$$

with the norm $\|(u, v)\|_X = \|u\|_{C([0, L])} + \|v\|_{C(D)}$, then (X, X^+) is an ordered Banach space and the cone X^+ has empty interior. Let Y be a closed subspace of X given by

$$Y = \{(u, v) \in C^1([0, L]) \times C^1(D) : v(\cdot, R) = 0 \text{ in } [0, L]\}$$

with the norm $\|(u, v)\|_Y = \|u\|_{C^1([0, L])} + \|v\|_{C^1(D)}$. It is seen that the inclusion map $Y \hookrightarrow X$ is a continuous linear map. Moreover, the cone Y^+ has nonempty interior $\text{Int}(Y^+)$, see e.g.

[150, Corollary 4.2], given by

$$\text{Int}(Y^+) = \{(u, v) \in Y^+ : (u, v) > (0, 0) \text{ in } [0, L] \times [0, R), \partial_y v(\cdot, R) < 0 \text{ in } [0, L]\}.$$

We write $(u_1, v_1) \ll (u_2, v_2)$ if $(u_1, v_1), (u_2, v_2) \in Y$ and $(u_2, v_2) - (u_1, v_1) \in \text{Int}(Y^+)$.

Set $\mathcal{H} := LZ$. We use \mathcal{C} to denote the set of all bounded and continuous function pairs from \mathcal{H} to X , and \mathcal{D} to denote the set of all bounded and continuous function pairs from \mathcal{H} to Y . Moreover, any element in X (Y) can be regarded as a constant function in \mathcal{C} (\mathcal{D}).

For any $u, v \in \mathcal{C}$, we write $u \geq v$ provided $u(x) \geq v(x)$ for all $x \in \mathcal{H}$, $u > v$ provided $u \geq v$ but $u \neq v$. For $u, v \in \mathcal{D}$, we write $u \gg v$ provided $u(x) \gg v(x)$ for all $x \in \mathcal{H}$. We equip \mathcal{C} (\mathcal{D}) with the compact open topology, i.e., $(u_n, v_n) \rightarrow (u, v)$ in \mathcal{C} (\mathcal{D}) means that $u_n(x) \rightarrow u(x)$ locally uniformly for $x \in \mathcal{H}$ and $v_n(x) \rightarrow v(x)$ locally uniformly for $x \in \mathcal{H}$.

Define

$$\begin{aligned} \mathbb{C}_0 &:= \{(u, v) \in C(\mathbb{R}) \times C(\overline{\Omega}_R) : v(\cdot, R) = 0 \text{ in } \mathbb{R}\}, \\ \mathbb{C}_0^1 &:= \{(u, v) \in C^1(\mathbb{R}) \times C^1(\overline{\Omega}_R) : v(\cdot, R) = 0 \text{ in } \mathbb{R}\}. \end{aligned}$$

Any continuous and bounded function pair (u, v) in \mathbb{C}_0 can be regarded as a function pair $(u(z), v(z))$ in the space \mathcal{C} in the sense that $(u(z)(x), v(z)(x, y)) := (u(x+z), v(x+z, y))$ for all $z \in \mathcal{H}$ and $(x, y) \in D$. In this sense, $(U_R, V_R) \in \mathcal{C}$ and the set

$$\mathcal{K} := \{(u, v) \in C(\mathbb{R}) \times C(\overline{\Omega}_R) : (0, 0) \leq (u, v) \leq (U_R, V_R) \text{ in } \overline{\Omega}_R\}$$

is a closed subset of $\mathcal{C}_{(U_R, V_R)} := \{(u, v) \in \mathcal{C} : (0, 0) \leq (u, v) \leq (U_R, V_R)\}$ and satisfies (K1)–(K5) in [114].

Define a family of operators $\{Q_t\}_{t \geq 0}$ on \mathcal{K} by

$$Q_t[(u_0, v_0)] := (u(t, \cdot; u_0), v(t, \cdot, \cdot; v_0)) \text{ for } (u_0, v_0) \in \mathcal{K},$$

where $(u(t, \cdot; u_0), v(t, \cdot, \cdot; v_0))$ is the solution of system (3.2) with initial datum $(u_0, v_0) \in \mathcal{K}$. It is easily seen that $Q_0[(u_0, v_0)] = (u_0, v_0)$ for all $(u_0, v_0) \in \mathcal{K}$, and $Q_t \circ Q_s[(u_0, v_0)] = Q_{t+s}[(u_0, v_0)]$ for any $t, s \geq 0$ and $(u_0, v_0) \in \mathcal{K}$. For any given $(u_0, v_0) \in \mathcal{K}$, it can be deduced from Proposition 3.15 that $Q_t[(u_0, v_0)]$ is continuous in $t \in [0, +\infty)$ with respect to the compact open topology.

Assume that (u_k, v_k) and (u, v) are the unique solutions to (3.2) with initial data (u_{0k}, v_{0k}) and (u_0, v_0) in \mathcal{K} , respectively. Suppose that $(u_{0k}, v_{0k}) \rightarrow (u_0, v_0)$ as $k \rightarrow +\infty$ locally uniformly in $\overline{\Omega}_R$, we claim that $(u_k, v_k) \rightarrow (u, v)$ as $k \rightarrow +\infty$ in $C_{loc}^{1,2}([0, +\infty) \times \overline{\Omega}_R)$, which will imply that $Q_t[(u_0, v_0)]$ is continuous in $(u_0, v_0) \in \mathcal{K}$ uniformly in $t \in [0, T]$ for any $T > 0$. To prove this, we define a smooth cut-off function $\chi^n : \mathbb{R} \mapsto [0, 1]$ such that $\chi^n(\cdot) = 1$ in $[-n+1, n-1]$ and $\chi^n(\cdot) = 0$ in $\mathbb{R} \setminus [-n, n]$. Then, $(\chi^n u_{0k}, \chi^n v_{0k}) \rightarrow (\chi^n u_0, \chi^n v_0)$ as

3. Spreading speeds and pulsating fronts for a field-road model in a periodic habitat

$k \rightarrow +\infty$ uniformly in $[-n, n]$. Let (u_k^n, v_k^n) and (u^n, v^n) be the solutions to (3.19) in $D_1 := [-n, n] \times [0, R]$ with initial data $(\chi^n u_{0k}, \chi^n v_{0k})$ and $(\chi^n u_0, \chi^n v_0)$, respectively. One can choose two positive bounded and monotone function sequences $(\underline{u}_{0k}^n, \underline{v}_{0k}^n)$ and $(\bar{u}_{0k}^n, \bar{v}_{0k}^n)$ in the space $\{(u, v) \in C^\infty([-n, n]) \times C^\infty(D_1) : u(\pm n) = 0, v(\cdot, R) = 0 \text{ in } [-n, n], v(\pm n, \cdot) = 0 \text{ in } [0, R]\}$, such that

$$(0, 0) \leq (\underline{u}_{0k}^n, \underline{v}_{0k}^n) \leq (\chi^n u_{0k}, \chi^n v_{0k}) \leq (\bar{u}_{0k}^n, \bar{v}_{0k}^n),$$

$$(\underline{u}_{0k}^n, \underline{v}_{0k}^n) \nearrow (\chi^n u_0, \chi^n v_0), (\bar{u}_{0k}^n, \bar{v}_{0k}^n) \searrow (\chi^n u_0, \chi^n v_0) \text{ uniformly in } D_1 \text{ as } k \rightarrow +\infty.$$

By a comparison argument, it follows that

$$(\underline{u}_k^n, \underline{v}_k^n) \leq (\underline{u}_{k+1}^n, \underline{v}_{k+1}^n) \leq (u_{k+1}^n, v_{k+1}^n) \leq (\bar{u}_{k+1}^n, \bar{v}_{k+1}^n) \leq (\bar{u}_k^n, \bar{v}_k^n) \text{ for all } t > 0 \text{ and } (x, y) \in D_1,$$

where $(\underline{u}_k^n, \underline{v}_k^n)$ and $(\bar{u}_k^n, \bar{v}_k^n)$ are the classical solutions to (3.19) with initial data $(\underline{u}_{0k}^n, \underline{v}_{0k}^n)$ and $(\bar{u}_{0k}^n, \bar{v}_{0k}^n)$, respectively. From standard parabolic estimates, the functions $(\underline{u}_k^n, \underline{v}_k^n)$ and $(\bar{u}_k^n, \bar{v}_k^n)$ converge to $(\underline{u}^n, \underline{v}^n)$ and (\bar{u}^n, \bar{v}^n) as $k \rightarrow +\infty$ in $C_{loc}^{1+\alpha/2, 2+\alpha}([0, +\infty) \times D_1)$, respectively. Moreover, $(\underline{u}^n, \underline{v}^n)$ and (\bar{u}^n, \bar{v}^n) are classical solutions to (3.19). Since

$$\lim_{t \rightarrow 0, k \rightarrow +\infty} (\underline{u}_k^n(t, \cdot), \underline{v}_k^n(t, \cdot, \cdot)) = \lim_{t \rightarrow 0, k \rightarrow +\infty} (\bar{u}_k^n(t, \cdot), \bar{v}_k^n(t, \cdot, \cdot)) = (\chi^n u_0, \chi^n v_0),$$

uniformly in $(x, y) \in D_1$, therefore

$$\lim_{t \rightarrow 0, k \rightarrow +\infty} (u_k^n(t, \cdot), v_k^n(t, \cdot, \cdot)) = (\chi^n u_0, \chi^n v_0) = \lim_{t \rightarrow 0} (u^n(t, \cdot), v^n(t, \cdot, \cdot)),$$

uniformly in $(x, y) \in D_1$, and by the uniqueness of the solutions to (3.19), it follows that

$$(\underline{u}^n, \underline{v}^n) = (\bar{u}^n, \bar{v}^n) = (u^n, v^n) \text{ for } t > 0 \text{ and } (x, y) \in D_1.$$

Hence, $(u_k^n, v_k^n) \rightarrow (u^n, v^n)$ as $k \rightarrow +\infty$ in $C^{1+\alpha/2, 2+\alpha}([0, T] \times D_1)$ for any $T > 0$. By the approximation argument and parabolic estimates, (u_k^n, v_k^n) and (u^n, v^n) converge, respectively, to (u_k, v_k) and (u, v) as $n \rightarrow +\infty$ (at least) in $C_{loc}^{1,2}([0, +\infty) \times \bar{\Omega}_R)$. Consequently, $(u_k, v_k) \rightarrow (u, v)$ as $k \rightarrow +\infty$ in $C_{loc}^{1,2}([0, +\infty) \times \bar{\Omega}_R)$.

From the observation that for any $t, s \geq 0$ and for $(u_0, v_0), (\tilde{u}_0, \tilde{v}_0) \in \mathcal{K}$,

$$|Q_t[(u_0, v_0)] - Q_s[(\tilde{u}_0, \tilde{v}_0)]| \leq |Q_t[(u_0, v_0)] - Q_t[(\tilde{u}_0, \tilde{v}_0)]| + |Q_t[(\tilde{u}_0, \tilde{v}_0)] - Q_s[(\tilde{u}_0, \tilde{v}_0)]|,$$

it comes that $Q_t[(u_0, v_0)]$ is continuous in $(t, (u_0, v_0)) \in [0, T] \times \mathcal{K}$. Note that for any $t > 0$, it can be expressed as $t = mT + t'$ for some $m \in \mathbb{Z}_+$ and $t' \in [0, T)$. Hence, $Q_t[(u_0, v_0)] = (Q_T)^m Q_{t'}[(u_0, v_0)]$. Thus, $Q_t[(u_0, v_0)]$ is continuous in $(t, (u_0, v_0)) \in [0, +\infty) \times \mathcal{K}$. Therefore, it follows that $\{Q_t\}_{t \geq 0}$ is a continuous-time semiflow. We claim that $\{Q_t\}_{t \geq 0}$ is subhomogeneous

3.4. Propagation properties in the strip: Proofs of Theorems 3.3 and 3.5

on \mathcal{K} in the sense that $Q_t[\kappa(u_0, v_0)] \geq \kappa Q_t[(u_0, v_0)]$ for all $\kappa \in [0, 1]$ and for all $(u_0, v_0) \in \mathcal{K}$. The case that $\kappa = 0, 1$ is trivial. Suppose now that $\kappa \in (0, 1)$. Define

$$(\bar{u}, \bar{v}) = (u(t, \cdot; \kappa u_0), v(t, \cdot, \cdot; \kappa v_0)), \quad (\underline{u}, \underline{v}) = \kappa(u(t, \cdot; u_0), v(t, \cdot, \cdot; v_0)).$$

From Proposition 3.13, it follows that (\bar{u}, \bar{v}) and $(\underline{u}, \underline{v})$ belong to \mathcal{K} . Moreover, (\bar{u}, \bar{v}) and $(\underline{u}, \underline{v})$ satisfy, respectively,

$$\begin{cases} \partial_t \bar{u} - D\partial_{xx} \bar{u} = \nu \bar{v}(t, x, 0) - \mu \bar{u}, & t > 0, x \in \mathbb{R}, \\ \partial_t \bar{v} - d\Delta \bar{v} = f(x, \bar{v}), & t > 0, (x, y) \in \Omega_R, \\ -d\partial_y \bar{v}(t, x, 0) = \mu \bar{u} - \nu \bar{v}(t, x, 0), & t > 0, x \in \mathbb{R}, \\ \bar{v}(t, x, R) = 0, & t > 0, x \in \mathbb{R}, \\ (\bar{u}_0, \bar{v}_0) = \kappa(u_0, v_0), \end{cases}$$

and

$$\begin{cases} \partial_t \underline{u} - D\partial_{xx} \underline{u} = \nu \underline{v}(t, x, 0) - \mu \underline{u}, & t > 0, x \in \mathbb{R}, \\ \partial_t \underline{v} - d\Delta \underline{v} < f(x, \underline{v}), & t > 0, (x, y) \in \Omega_R, \\ -d\partial_y \underline{v}(t, x, 0) = \mu \underline{u} - \nu \underline{v}(t, x, 0), & t > 0, x \in \mathbb{R}, \\ \underline{v}(t, x, R) = 0, & t > 0, x \in \mathbb{R}, \\ (\underline{u}_0, \underline{v}_0) = \kappa(u_0, v_0), \end{cases}$$

by using the assumption that $f(x, v)/v$ is decreasing in $v > 0$ for all $x \in \mathbb{R}$. Proposition 3.13 then yields that $\bar{u}(t, x) \geq \underline{u}(t, x)$ and $\bar{v}(t, x, y) \geq \underline{v}(t, x, y)$ for all $t \geq 0$ and $(x, y) \in \bar{\Omega}_R$. This proves our claim. By classical parabolic theory, together with Propositions 3.13–3.15 and Theorem 3.1, for each $t > 0$, the solution map $Q_t : \mathcal{K} \rightarrow \mathcal{K}$ satisfies the following properties:

- (A1) $Q_t[T_a[(u_0, v_0)]] = T_a[Q_t[(u_0, v_0)]]$ for all $(u_0, v_0) \in \mathcal{K}$ and $a \in \mathcal{H}$, where T_a is a shift operator defined by $T_a[(u(t, x), v(t, x, y))] = (u(t, x - a), v(t, x - a, y))$.
- (A2) $Q_t[\mathcal{K}]$ is uniformly bounded and $Q_t : \mathcal{K} \rightarrow \mathcal{D}$ is continuous with respect to the compact open topology, due to the analysis above.
- (A3) $Q_t : \mathcal{K} \rightarrow \mathcal{D}$ is compact with respect to the compact open topology, which follows from Proposition 3.15.
- (A4) $Q_t : \mathcal{K} \rightarrow \mathcal{K}$ is monotone (order-preserving) in the sense that if (u_{01}, v_{01}) and (u_{02}, v_{02}) belong to \mathcal{K} satisfying $u_{01} \leq u_{02}$ in \mathbb{R} and $v_{01} \leq v_{02}$ in $\bar{\Omega}_R$, then $u(t, x; u_{01}) \leq u(t, x; u_{02})$ and $v(t, x, y; v_{01}) \leq v(t, x, y; v_{02})$ for all $t > 0$ and $(x, y) \in \bar{\Omega}_R$. This follows from Proposition 3.13.
- (A5) Q_t admits exactly two fixed points $(0, 0)$ and (U_R, V_R) in Y . Let $(u(t, x; u_0), v(t, x, y; v_0))$ be the solution of (3.2) with L -periodic (in x) initial value $(u_0, v_0) \in \mathcal{K} \cap Y$ satisfying

3. Spreading speeds and pulsating fronts for a field-road model in a periodic habitat

$(0, 0) \ll (u_0, v_0) \leq (U_R, V_R)$, it comes that

$$\lim_{t \rightarrow +\infty} (u(t, x; u_0), v(t, x, y; v_0)) = (U_R(x), V_R(x, y)) \text{ uniformly in } (x, y) \in \bar{\Omega}_R. \quad (3.27)$$

Indeed, Theorem 3.1 implies that (U_R, V_R) is the unique L -periodic positive steady state of (3.2). Moreover, (3.27) can be achieved by a similar argument to that of Theorem 3.1.

Therefore, Q_t is a subhomogeneous semiflow on \mathcal{K} and satisfies hypotheses (A1)–(A5) in [114] for any $t > 0$. Moreover, it is straightforward to check that assumption (A6) in [114] is also satisfied. In particular, Q_1 satisfies (A1)–(A6) in [114]. By Theorem 3.1 and Proposition 3.2 in [114], it then follows that the solution map Q_1 admits rightward and leftward spreading speeds $c_{R,\pm}^*$. Furthermore, Theorems 4.1–4.2 in [114] imply that Q_1 has a rightward periodic traveling wave $(\phi_R(x - c, x), \psi_R(x - c, x, y))$ connecting (U_R, V_R) and $(0, 0)$ such that $(\phi_R(s, x), \psi_R(s, x, y))$ is non-increasing in s if and only if $c \geq c_{R,+}^*$. Similar results holds for leftward periodic traveling waves with minimal wave speed $c_{R,-}^*$.

To obtain the variational formulas for $c_{R,\pm}^*$, we use the linear operators approach. Let us consider the linearization of the truncated problem (3.2) at its zero solution:

$$\begin{cases} \partial_t u - D\partial_{xx}u = \nu v(t, x, 0) - \mu u, & t > 0, x \in \mathbb{R}, \\ \partial_t v - d\Delta v = f_v(x, 0)v, & t > 0, (x, y) \in \Omega_R, \\ -d\partial_y v(t, x, 0) = \mu u - \nu v(t, x, 0), & t > 0, x \in \mathbb{R}, \\ v(t, x, R) = 0, & t > 0, x \in \mathbb{R}. \end{cases} \quad (3.28)$$

Let $\{L(t)\}_{t \geq 0}$ be the linear solution semigroup generated by (3.28), that is, $L(t)[(u_0, v_0)] = (u_t(u_0), v_t(v_0))$, where $(u_t(u_0), v_t(v_0)) := (u(t, \cdot; u_0), v(t, \cdot, \cdot; v_0))$ is the solution of (3.28) with initial value $(u_0, v_0) \in \mathcal{D}$. For any given $\alpha \in \mathbb{R}$, substituting $(u(t, x), v(t, x, y)) = e^{-\alpha x}(\tilde{u}(t, x), \tilde{v}(t, x, y))$ in (3.28) yields

$$\begin{cases} \partial_t \tilde{u} - D\partial_{xx}\tilde{u} + 2D\alpha\partial_x\tilde{u} - D\alpha^2\tilde{u} = \nu\tilde{v}(t, x, 0) - \mu\tilde{u}, & t > 0, x \in \mathbb{R}, \\ \partial_t \tilde{v} - d\Delta\tilde{v} + 2d\alpha\partial_x\tilde{v} - d\alpha^2\tilde{v} = f_v(x, 0)\tilde{v}, & t > 0, (x, y) \in \Omega_R, \\ -d\partial_y\tilde{v}(t, x, 0) = \mu\tilde{u} - \nu\tilde{v}(t, x, 0), & t > 0, x \in \mathbb{R}, \\ \tilde{v}(t, x, R) = 0, & t > 0, x \in \mathbb{R}. \end{cases} \quad (3.29)$$

Let $\{L_\alpha(t)\}_{t \geq 0}$ be the linear solution semigroup generated by (3.29), then one has $L_\alpha(t)[(\tilde{u}_0, \tilde{v}_0)] = (\tilde{u}_t(\tilde{u}_0), \tilde{v}_t(\tilde{v}_0))$, where $(\tilde{u}_t(\tilde{u}_0), \tilde{v}_t(\tilde{v}_0)) := (\tilde{u}(t, \cdot; \tilde{u}_0), \tilde{v}(t, \cdot, \cdot; \tilde{v}_0))$ is the solution of (3.29) with initial value $(\tilde{u}_0, \tilde{v}_0) = (u_0, v_0)e^{\alpha x}$. It then follows that, for any $(\tilde{u}_0, \tilde{v}_0) \in \mathcal{D}$,

$$L(t)[e^{-\alpha x}(\tilde{u}_0, \tilde{v}_0)] = e^{-\alpha x}L_\alpha(t)[(\tilde{u}_0, \tilde{v}_0)] \text{ for } t \geq 0 \text{ and } (x, y) \in \bar{\Omega}_R.$$

Substituting $(\tilde{u}(t, x), \tilde{v}(t, x, y)) = e^{-\sigma t}(p(x), q(x, y))$, with p, q periodic (in x), into (3.29) leads to the following periodic eigenvalue problem:

$$\begin{cases} \mathcal{L}_{1,\alpha}(p, q) := -Dp'' + 2D\alpha p' + (-D\alpha^2 + \mu)p - \nu q(x, 0) = \sigma p, & x \in \mathbb{R}, \\ \mathcal{L}_{2,\alpha}(p, q) := -d\Delta q + 2d\alpha \partial_x q - (d\alpha^2 + f_v(x, 0))q = \sigma q, & (x, y) \in \Omega_R, \\ \mathcal{B}(p, q) := -d\partial_y q(x, 0) + \nu q(x, 0) - \mu p = 0, & x \in \mathbb{R}, \\ q(x, R) = 0, & x \in \mathbb{R}, \\ p, q \text{ are } L\text{-periodic with respect to } x. \end{cases} \quad (3.30)$$

Recall that $M := \max_{[0,L]} f_v(x, 0)$ and $m := \min_{[0,L]} f_v(x, 0)$. We have:

Proposition 3.18. *Set $\zeta(x) := f_v(x, 0)$. For all $\alpha \in \mathbb{R}$, the periodic eigenvalue problem (3.30) admits the principal eigenvalue $\lambda_{R,\zeta}(\alpha) \in \mathbb{R}$ with a unique (up to multiplication by some constant) positive periodic (in x) eigenfunction pair (p, q) belonging to $C^3(\mathbb{R}) \times C^3(\overline{\Omega}_R)$. Moreover, $\lambda_{R,\zeta}(\alpha)$ has the following properties:*

(i) *For all $\alpha \in \mathbb{R}$, the principal eigenvalue $\lambda_{R,\zeta}(\alpha)$ is equal to*

$$\lambda_{R,\zeta}(\alpha) = \max_{(p,q) \in \Sigma} \min \left\{ \inf_{\mathbb{R}} \frac{\mathcal{L}_{1,\alpha}(p, q)}{p}, \inf_{\mathbb{R} \times [0, R]} \frac{\mathcal{L}_{2,\alpha}(p, q)}{q} \right\}, \quad (3.31)$$

where

$$\begin{aligned} \Sigma := & \{ (p, q) \in C^2(\mathbb{R}) \times C^2(\overline{\Omega}_R) : p > 0 \text{ in } \mathbb{R}, q > 0 \text{ in } \mathbb{R} \times [0, R], \\ & p, q \text{ are } L\text{-periodic in } x, \mathcal{B}(p, q) = 0 \text{ in } \mathbb{R}, \partial_y q(\cdot, R) < 0 = q(\cdot, R) \text{ in } \mathbb{R} \}. \end{aligned}$$

(ii) *For fixed R and for all $\alpha \in \mathbb{R}$, $\zeta \mapsto \lambda_{R,\zeta}(\alpha)$ is non-increasing in the sense that, if $\zeta_1(x) \leq \zeta_2(x)$ for all $x \in \mathbb{R}$, then $\lambda_{R,\zeta_1}(\alpha) \geq \lambda_{R,\zeta_2}(\alpha)$. Moreover, $\lambda_{R,\zeta}(\alpha)$ is continuous with respect to ζ in the sense that, if $\zeta_n \rightarrow \zeta$, then $\lambda_{R,\zeta_n}(\alpha) \rightarrow \lambda_{R,\zeta}(\alpha)$.*

(iii) *For all $\alpha \in \mathbb{R}$, $\lambda_{R,\zeta}(\alpha)$ is decreasing with respect to R .*

(iv) *For fixed R , $\alpha \mapsto \lambda_{R,\zeta}(\alpha)$ is concave in \mathbb{R} and satisfies*

$$\max \left\{ D\alpha^2 - \mu, d\alpha^2 + m - d\frac{\pi^2}{R^2} \right\} < -\lambda_{R,\zeta}(\alpha) < \max \left\{ D\alpha^2 + \nu - \mu + \frac{\mu\nu}{d}, d(\alpha^2 + 1) + M \right\}. \quad (3.32)$$

Proof of Proposition 3.18. The proof is divided into six steps.

Step 1. Solving the eigenvalue problem (3.30). Set $\Lambda_\zeta(\alpha) := \max \{ D\alpha^2 + \nu - \mu + \mu\nu/d, d(\alpha^2 + 1) + M \}$. We introduce a Banach space \mathcal{F} of periodic (in x) function pairs

3. Spreading speeds and pulsating fronts for a field-road model in a periodic habitat

(u, v) belonging to $C^1(\mathbb{R}) \times C^1(\overline{\Omega}_R)$ such that $v(\cdot, R) = 0$ in \mathbb{R} , equipped with $\|(u, v)\|_{\mathcal{F}} = \|u\|_{C^1([0, L])} + \|u\|_{C^1([0, L] \times [0, R])}$. For any $(g_1, g_2) \in \mathcal{F}$ and $\Lambda \geq \Lambda_\zeta(\alpha)$, let us consider the modified problem:

$$\begin{cases} \mathcal{L}_{1,\alpha}(p, q) + \Lambda p = g_1, & x \in \mathbb{R}, \\ \mathcal{L}_{2,\alpha}(p, q) + \Lambda q = g_2, & (x, y) \in \Omega_R, \\ \mathcal{B}(p, q) = 0, & x \in \mathbb{R}, \\ q(x, R) = 0, & x \in \mathbb{R}, \\ p, q \text{ are } L\text{-periodic with respect to } x. \end{cases} \quad (3.33)$$

First, we construct ordered super- and subsolutions for problem (3.33). Set $(\bar{p}, \bar{q}) = K(1, 1 + \frac{\mu}{d}e^{-y})$. Choosing $K > 0$ large enough (depending only on $\|g_1\|_{L^\infty(\mathbb{R})}$ and $\|g_2\|_{L^\infty(\overline{\Omega}_R)}$ if g_1, g_2 are positive), it follows that (\bar{p}, \bar{q}) is indeed a strict supersolution of (3.33). By linearity of (3.33), up to increasing K (depending only on $\|g_1\|_{L^\infty(\mathbb{R})}$ and $\|g_2\|_{L^\infty(\overline{\Omega}_R)}$ if g_1, g_2 are negative), $(\underline{p}, \underline{q}) := -(\bar{p}, \bar{q})$ is a negative strict subsolution of (3.33). By monotone iteration method, it is known that the associated evolution problem of (3.33) with initial datum (\bar{p}, \bar{q}) is uniquely solvable and its solution (\bar{u}, \bar{v}) is decreasing in time and is bounded from below by $(\underline{p}, \underline{q})$ and from above by (\bar{p}, \bar{q}) , respectively. From the monotone convergence theorem as well as elliptic regularity theory up to the boundary, it follows that (\bar{u}, \bar{v}) converges as $t \rightarrow +\infty$ locally uniformly in $\overline{\Omega}_R$ to a classical periodic (in x) solution $(p, q) \in C^3(\mathbb{R}) \times C^3(\overline{\Omega}_R)$ of problem (3.33). To prove uniqueness of the solution to (3.33), we first claim that $g_1 \geq 0$ in \mathbb{R} , $g_2 \geq 0$ in $\overline{\Omega}_R$ implies that $p \geq 0$ in \mathbb{R} , $q \geq 0$ in $\mathbb{R} \times [0, R]$. Indeed, for any fixed nonnegative function pair $(g_1, g_2) \in \mathcal{F}$, let (p, q) be the unique solution to (3.33). One can easily check that, for any $K > 0$, $(\underline{p}, \underline{q})$ defined as above is a strict subsolution of (3.33). Assume that p or q attains a negative value somewhere in their respective domains. Define

$$\theta^* := \min \{ \theta > 0 : (p, q) \geq \theta(\underline{p}, \underline{q}) \text{ in } \overline{\Omega}_R \}.$$

Then, $\theta^* \in (0, +\infty)$. The function pair $(p - \theta^*\underline{p}, q - \theta^*\underline{q})$ is nonnegative and at least one component attains zero somewhere in $\mathbb{R} \times [0, R]$ by noticing $(q - \theta^*\underline{q})(\cdot, R) > 0$ in \mathbb{R} . Set $(w, z) := (p - \theta^*\underline{p}, q - \theta^*\underline{q})$, then it satisfies

$$\begin{cases} -Dw'' + 2D\alpha w' + (\Lambda - D\alpha^2 + \mu)w - \nu z(x, 0) \geq 0, & x \in \mathbb{R}, \\ -d\Delta z + 2d\alpha\partial_x z + (\Lambda - d\alpha^2 - \zeta(x))z > 0, & (x, y) \in \Omega_R, \\ -d\partial_y z(x, 0) + \nu z(x, 0) - \mu w > 0, & x \in \mathbb{R}, \\ z(x, R) > 0, & x \in \mathbb{R}, \\ w, z \text{ are } L\text{-periodic with respect to } x. \end{cases} \quad (3.34)$$

Assume first that there is $(x_0, y_0) \in \mathbb{R} \times [0, R)$ such that $z(x_0, y_0) = 0$. There are two subcases. Suppose that $(x_0, y_0) \in \Omega_R$, then the strong maximum principle implies that $z \equiv 0$ in Ω_R . This contradicts the strict inequality of z in (3.34), whence $z > 0$ in Ω_R . Suppose now that $y_0 = 0$ and $z(x_0, 0) = 0$, it follows that $\partial_y z(x_0, 0) > 0$. One then deduces from $-d\partial_y z(x_0, 0) + \nu z(x_0, 0) - \mu w(x_0) > 0$ that $w(x_0) < -(d/\mu)\partial_y z(x_0, 0) < 0$, which is impossible since $w \geq 0$ in \mathbb{R} . Therefore, $z > 0$ in $\overline{\Omega}_R$. It is seen from the first inequality of (3.34) that

$$-Dw'' + 2D\alpha w' + (\Lambda - D\alpha^2 + \mu)w \geq \nu z(\cdot, 0) > 0 \text{ in } \mathbb{R}. \quad (3.35)$$

Finally, assume that there is $x_0 \in \mathbb{R}$ such that $w(x_0) = 0$, then the strong maximum principle implies that $w \equiv 0$ in \mathbb{R} . This contradicts the strict inequality in (3.35). Consequently, $p \geq 0$ on \mathbb{R} and $q \geq 0$ in $\overline{\Omega}_R$. If we further assume that $g_1 \not\equiv 0$ in \mathbb{R} or $g_2 \not\equiv 0$ in $\mathbb{R} \times [0, R)$, then $p > 0$ in \mathbb{R} and $q > 0$ in $\mathbb{R} \times [0, R)$. This can be proved by the strong maximum principle and by a similar argument as above.

To prove uniqueness, we assume that (p_1, q_1) and (p_2, q_2) are two distinct solutions of (3.33), then $(p_1 - p_2, q_1 - q_2)$ satisfies (3.33) with $g_1 = 0$ and $g_2 = 0$. Using the result derived from above, we conclude that $p_1 \equiv p_2$ in \mathbb{R} , $q_1 \equiv q_2$ in $\overline{\Omega}_R$.

According to (3.33), one defines an operator $T : \mathcal{F} \rightarrow \mathcal{F}$, $(g_1, g_2) \mapsto (p, q) = T(g_1, g_2)$. Obviously, the mapping T is linear. Moreover, we notice that the solution (p, q) of (3.33) has a global bound which depends only on $\|g_1\|_{L^\infty(\mathbb{R})}$ and $\|g_2\|_{L^\infty(\overline{\Omega}_R)}$. By regularity estimates, $(p, q) = T(g_1, g_2)$ belongs to $C^3(\mathbb{R}) \times C^3(\overline{\Omega}_R)$, whence $(p, q) \in \mathcal{F}$. Therefore, T is compact.

Let K be the cone $K = \{(u, v) \in \mathcal{F} : u \geq 0 \text{ in } \mathbb{R}, v \geq 0 \text{ in } \overline{\Omega}_R\}$. Its interior $K^\circ = \{(u, v) \in \mathcal{F} : u > 0 \text{ in } \mathbb{R}, v > 0 \text{ in } \mathbb{R} \times [0, R)\} \neq \emptyset$ (for instance, $(u, v(y)) = (1, 1 - y/R)$ belongs to K°) and $K \cap (-K) = (0, 0)$. By the analysis above, $T(K^\circ) \subset K^\circ$ and T is strongly positive in the sense that, if $(g_1, g_2) \in K \setminus \{(0, 0)\}$, then $p > 0$ in \mathbb{R} and $q > 0$ in $\mathbb{R} \times [0, R)$.

From the classical Krein-Rutman theory, there exists a unique positive real number $\lambda_{R,\zeta}^*(\alpha)$ and a unique (up to multiplication by constants) function pair $(p, q) \in K^\circ$ such that $\lambda_{R,\zeta}^*(\alpha)T(p, q) = (p, q)$. The principal eigenvalue $\lambda_{R,\zeta}^*(\alpha)$ depends on R , α and ζ . Set $\lambda_{R,\zeta}(\alpha) := \lambda_{R,\zeta}^*(\alpha) - \Lambda$, then the function $\lambda_{R,\zeta}(\alpha)$ takes value in \mathbb{R} . For each $\alpha \in \mathbb{R}$, (p, q) is the unique (up to multiplication by constants) positive eigenfunction pair of (3.30) associated with $\lambda_{R,\zeta}(\alpha)$.

Step 2. Proof of formula (3.31). We notice from Step 1 that $(p, q) \in \Sigma$. It then follows that

$$\lambda_{R,\zeta}(\alpha) \leq \sup_{(p,q) \in \Sigma} \min \left\{ \inf_{\mathbb{R}} \frac{\mathcal{L}_{1,\alpha}(p, q)}{p}, \inf_{\mathbb{R} \times [0, R)} \frac{\mathcal{L}_{2,\alpha}(p, q)}{q} \right\}.$$

To show the reverse inequality, assume by contradiction that there exists $(p_1, q_1) \in \Sigma$ such that

$$\lambda_{R,\zeta}(\alpha) < \min \left\{ \inf_{\mathbb{R}} \frac{\mathcal{L}_{1,\alpha}(p_1, q_1)}{p_1}, \inf_{\mathbb{R} \times [0, R)} \frac{\mathcal{L}_{2,\alpha}(p_1, q_1)}{q_1} \right\}.$$

3. Spreading speeds and pulsating fronts for a field-road model in a periodic habitat

Define

$$\theta^* := \min \{ \theta > 0 : \theta(p_1, q_1) \geq (p, q) \text{ in } \mathbb{R} \times [0, R) \}.$$

Then, $\theta^* > 0$ and $(\theta^*p_1 - p, \theta^*q_1 - q)$ is nonnegative and two cases may occur, namely, either at least one component attains zero somewhere in $\mathbb{R} \times [0, R)$, or $\theta^*p_1 - p > 0$ in \mathbb{R} , $\theta^*q_1 - q > 0$ in $[0, R)$ and $\partial_y(\theta^*q_1 - q)(x_0, R) = 0$ for some $x_0 \in \mathbb{R}$. Set $(w, z) := (\theta^*p_1 - p, \theta^*q_1 - q)$, then (w, z) satisfies

$$\begin{cases} -Dw'' + 2D\alpha w' + (-D\alpha^2 + \mu - \lambda_{R,\zeta}(\alpha))w - \nu z(x, 0) > 0, & x \in \mathbb{R}, \\ -d\Delta z + 2d\alpha\partial_x z - (d\alpha^2 + \zeta(x) + \lambda_{R,\zeta}(\alpha))z > 0, & (x, y) \in \Omega_R, \\ -d\partial_y z(x, 0) + \nu z(x, 0) - \mu w = 0, & x \in \mathbb{R}, \\ z(x, R) = 0, & x \in \mathbb{R}, \\ w, z \text{ are } L\text{-periodic with respect to } x. \end{cases} \quad (3.36)$$

For the first case, assume first that there is $(x_0, y_0) \in \mathbb{R} \times [0, R)$ such that $z(x_0, y_0) = 0$. We divide into two subcases. Suppose that $(x_0, y_0) \in \Omega_R$, then the strong maximum principle implies that $z \equiv 0$ in Ω_R . This contradicts the strict inequality of z in (3.36), whence $z > 0$ in Ω_R . Suppose now that $y_0 = 0$ and $z(x_0, 0) = 0$, it follows that $\partial_y z(x_0, 0) > 0$. One then deduces from $-d\partial_y z(x_0, 0) + \nu z(x_0, 0) - \mu w(x_0) = 0$ that $w(x_0) = -(d/\mu)\partial_y z(x_0, 0) < 0$, which is impossible since $w \geq 0$ in \mathbb{R} . Therefore, $z > 0$ in $\mathbb{R} \times [0, R)$. It is seen from the first inequality of (3.36) that

$$-Dw'' + 2D\alpha w' + (-D\alpha^2 + \mu - \lambda_{R,\zeta}(\alpha))w > \nu z(\cdot, 0) > 0 \text{ in } \mathbb{R}.$$

Finally, assume that there is $x_0 \in \mathbb{R}$ such that $w(x_0) = 0$, then the strong maximum principle implies that $w \equiv 0$ in \mathbb{R} , contradicting the strict inequality above. Consequently, one has $w > 0$ in \mathbb{R} and $z > 0$ in $\mathbb{R} \times [0, R)$. On the other hand, by Hopf lemma it follows that $\partial_y z(\cdot, R) < 0$ in \mathbb{R} , whence the second case is ruled out. Therefore,

$$\lambda_{R,\zeta}(\alpha) \geq \sup_{(p,q) \in \Sigma} \min \left\{ \inf_{\mathbb{R}} \frac{\mathcal{L}_{1,\alpha}(p, q)}{p}, \inf_{\mathbb{R} \times [0, R)} \frac{\mathcal{L}_{2,\alpha}(p, q)}{q} \right\}.$$

Therefore, formula (3.31) is proven and the supremum is indeed the maximum since (3.31) is reached by the function pair $(p, q) \in \Sigma_\alpha$. Therefore, (i) is proved.

Step 3. Monotonicity and continuity of the function $\zeta \mapsto \lambda_{R,\zeta}(\alpha)$ for all $\alpha \in \mathbb{R}$. For any fixed R , if $\zeta_1(x) \leq \zeta_2(x)$ in \mathbb{R} , formula (3.31) together with the definition of the operator $\mathcal{L}_{2,\alpha}$ immediately implies that $\lambda_{\zeta_1}(\alpha) \geq \lambda_{\zeta_2}(\alpha)$ for all $\alpha \in \mathbb{R}$.

Assume now that $\zeta_n \rightarrow \zeta$ as $n \rightarrow +\infty$, we have to show that $\lambda_{R,\zeta_n}(\alpha) \rightarrow \lambda_{R,\zeta}(\alpha)$ as $n \rightarrow +\infty$. Let $(\lambda_{R,\zeta_n}(\alpha); (p_n, q_n))$ be the principal eigenpair of (3.30) with ζ replaced by ζ_n

satisfying the normalization $\|p_n\|_{L^\infty(\mathbb{R})} = 1$. From Step 1, it is seen that (p_n, q_n) belongs to $C^3(\mathbb{R}) \times C^3(\overline{\Omega}_R)$. By elliptic estimates, up to extraction of some subsequence, (p_n, q_n) converges as $n \rightarrow +\infty$ uniformly in $\overline{\Omega}_R$ to a positive function pair $(p, q) \in C^3(\mathbb{R}) \times C^3(\overline{\Omega}_R)$ which satisfies (3.30) associated with $\tilde{\lambda}_R(\alpha)$ with normalization $\|p\|_{L^\infty(\mathbb{R})} = 1$. By the uniqueness of the principal eigenpair of (3.30), it follows that $\tilde{\lambda}_{R,\zeta}(\alpha) = \lambda_{R,\zeta}(\alpha)$. Namely, $\lambda_{R,\zeta_n}(\alpha) \rightarrow \lambda_{R,\zeta}(\alpha)$ as $n \rightarrow +\infty$. This completes the proof of (ii).

Step 4. Monotonicity of the function $R \mapsto \lambda_{R,\zeta}(\alpha)$ for all $\alpha \in \mathbb{R}$. Fix $\alpha \in \mathbb{R}$ and choose $R_1 > R_2$. Set $\lambda_1 = \lambda_{R_1,\zeta}(\alpha)$ and $\lambda_2 = \lambda_{R_2,\zeta}(\alpha)$ and let $(\lambda_1; (p_1, q_1))$ and $(\lambda_2; (p_2, q_2))$ be the eigenpairs of (3.30) in $\overline{\Omega}_{R_1}$ and in $\overline{\Omega}_{R_2}$, respectively. Define

$$\theta^* := \min\{\theta > 0 : \theta(p_1, q_1) \geq (p_2, q_2) \text{ in } \overline{\Omega}_{R_2}\}.$$

Then, $\theta^* > 0$ is well-defined. The function pair $(w, z) := (\theta^*p_1 - p_2, \theta^*q_1 - q_2)$ is nonnegative and at least one component attains zero somewhere in $\mathbb{R} \times [0, R_2]$ by noticing that $q_1|_{y=R_2} > q_2|_{y=R_2} = 0$. Moreover, (w, z) satisfies

$$\begin{cases} -Dw'' + 2D\alpha w' + (-D\alpha^2 + \mu)w - \nu z(x, 0) = \theta^* \lambda_1 p_1 - \lambda_2 p_2, & x \in \mathbb{R}, \\ -d\Delta z + 2d\alpha \partial_x z - (d\alpha^2 + \zeta(x))z = \theta^* \lambda_1 q_1 - \lambda_2 q_2, & (x, y) \in \Omega_{R_2}, \\ -d\partial_y z(x, 0) + \nu z(x, 0) - \mu w = 0, & x \in \mathbb{R}, \\ z(x, R_2) > 0, & x \in \mathbb{R}, \\ w, z \text{ are } L\text{-periodic with respect to } x. \end{cases} \quad (3.37)$$

Assume that there is $x_0 \in \mathbb{R}$ such that $w(x_0) = 0$, it follows from the first equation in (3.37) that

$$-Dw''(x_0) + 2D\alpha w'(x_0) + (-D\alpha^2 + \mu)w(x_0) - \nu z(x_0, 0) = (\lambda_1 - \lambda_2)p_2(x_0),$$

Since the function w attains its minimum at x_0 , one has $w'(x_0) = 0$ and $w''(x_0) \geq 0$, whence $(\lambda_1 - \lambda_2)p_2(x_0) \leq -\nu z(x_0, 0) \leq 0$, therefore $\lambda_1 \leq \lambda_2$. Assume now that there is $(x_0, y_0) \in \mathbb{R} \times [0, R_2]$ such that $z(x_0, y_0) = 0$, we distinguish two subcases. Suppose that $y_0 \in (0, R)$, a similar analysis of the second equation in (3.37) as above implies that $\lambda_1 \leq \lambda_2$. Otherwise, $z > 0$ in Ω_R and $z(x_0, 0) = 0$, which leads to $w(x_0) = -(d/\mu)\partial_y z(x_0, 0) < 0$. This contradicts $w \geq 0$ in \mathbb{R} . To sum up, one obtains $\lambda_1 \leq \lambda_2$. Moreover, $\lambda_1 = \lambda_2$ is impossible, otherwise (p_1, q_1) would be a positive multiple of (p_2, q_2) , which contradicts $q_1|_{y=R_2} > q_2|_{y=R_2} = 0$. As a consequence, $\lambda_1 < \lambda_2$, namely, the function $R \mapsto \lambda_{R,\zeta}$ is decreasing. The proof of (iii) is complete.

Step 5. The concavity of the function $\alpha \mapsto \lambda_{R,\zeta}(\alpha)$. Let $(\lambda_{R,\zeta}(\alpha); (p, q))$ be the principal eigenpair of (3.30). With the change of functions $(p, q) = e^{\alpha x}(\Phi, \Psi)$ in formula (3.31), one

3. Spreading speeds and pulsating fronts for a field-road model in a periodic habitat

has

$$\frac{\mathcal{L}_{1,\alpha}(p, q)}{p} = \frac{-D\Phi'' - \nu\Psi(x, 0)}{\Phi} + \mu, \quad \frac{\mathcal{L}_{2,\alpha}(p, q)}{q} = \frac{-d\Delta\Psi}{\Psi} - \zeta(x).$$

Then, it is immediate to see that

$$\lambda_{R,\zeta}(\alpha) = \max_{(\Phi, \Psi) \in \Sigma'_\alpha} \min \left\{ \inf_{\mathbb{R}} \frac{-D\Phi'' - \nu\Psi(x, 0)}{\Phi} + \mu, \inf_{\mathbb{R} \times [0, R]} \frac{-d\Delta\Psi}{\Psi} - \zeta(x) \right\},$$

where $\Sigma'_\alpha := \{(\Phi, \Psi) \in C^2(\mathbb{R}) \times C^2(\overline{\Omega}_R) : e^{\alpha x}(\Phi, \Psi) \in \Sigma_\alpha\}$. Let α_1, α_2 be real numbers and $t \in [0, 1]$. Set $\alpha = t\alpha_1 + (1-t)\alpha_2$. One has to show that $\lambda_{R,\zeta}(\alpha) \geq t\lambda_{R,\zeta}(\alpha_1) + (1-t)\lambda_{R,\zeta}(\alpha_2)$. Let (Φ_1, Ψ_1) and (Φ_2, Ψ_2) be two arbitrarily chosen function pairs in Σ'_{α_1} and Σ'_{α_2} , respectively. Set $(w_1, z_1) = (\ln \Phi_1, \ln \Psi_1)$, $(w_2, z_2) = (\ln \Phi_2, \ln \Psi_2)$, $w = tw_1 + (1-t)w_2$, $z = tz_1 + (1-t)z_2$ and $(\Phi, \Psi) = (e^w, e^z)$. It follows that $(\Phi, \Psi) \in \Sigma'_\alpha$. Then, it is obvious to see that

$$\lambda_{R,\zeta}(\alpha) \geq \min \left\{ \inf_{\mathbb{R}} \frac{-D\Phi'' - \nu\Psi(x, 0)}{\Phi} + \mu, \inf_{\mathbb{R} \times [0, R]} \frac{-d\Delta\Psi}{\Psi} - \zeta(x) \right\}.$$

After some calculations, one has

$$\frac{-D\Phi'' - \nu\Psi(x, 0)}{\Phi} = -Dw'' - Dw'^2 - \nu e^{z(x,0)-w(x)}, \quad \frac{-d\Delta\Psi}{\Psi} = -d\Delta z - d\nabla z \cdot \nabla z.$$

Noticing that $x \mapsto e^x$ is convex, $\nu > 0$ and $t(1-t) \geq 0$, it follows that

$$\begin{aligned} \frac{-D\Phi'' - \nu\Psi(x, 0)}{\Phi} + \mu &\geq t(-Dw_1'' - Dw_1'^2 - \nu e^{z_1(x,0)-w_1}) \\ &\quad + (1-t)(-Dw_2'' - Dw_2'^2 - \nu e^{z_2(x,0)-w_2}) + \mu \\ &\geq t \left(\frac{-D\Phi_1'' - \nu\Psi_1(x, 0)}{\Phi_1} + \mu \right) + (1-t) \left(\frac{-D\Phi_2'' - \nu\Psi_2(x, 0)}{\Phi_2} + \mu \right). \end{aligned}$$

Similarly,

$$\frac{-d\Delta\Psi}{\Psi} - \zeta(x) \geq t \left(\frac{-d\Delta\Psi_1}{\Psi_1} - \zeta(x) \right) + (1-t) \left(\frac{-d\Delta\Psi_2}{\Psi_2} - \zeta(x) \right).$$

Therefore,

$$\begin{aligned} \lambda_{R,\zeta}(\alpha) &\geq t \min \left\{ \inf_{\mathbb{R}} \frac{-D\Phi_1'' - \nu\Psi_1(x, 0)}{\Phi_1} + \mu, \inf_{\mathbb{R}} \frac{-d\Delta\Psi_1}{\Psi_1} - \zeta(x) \right\} \\ &\quad + (1-t) \min \left\{ \inf_{\mathbb{R}} \frac{-D\Phi_2'' - \nu\Psi_2(x, 0)}{\Phi_2} + \mu, \inf_{\mathbb{R}} \frac{-d\Delta\Psi_2}{\Psi_2} - \zeta(x) \right\}. \end{aligned}$$

Since (Φ_1, Ψ_1) and (Φ_2, Ψ_2) were arbitrarily chosen, one concludes that $\lambda_{R,\zeta}(\alpha) \geq t\lambda_{R,\zeta}(\alpha_1) + (1-t)\lambda_{R,\zeta}(\alpha_2)$. That is, $\alpha \mapsto \lambda_{R,\zeta}(\alpha)$ is concave in \mathbb{R} and then continuous in \mathbb{R} .

Step 6. *The upper and lower bounds (3.32) of $\lambda_{R,\zeta}(\alpha)$.* From Step 1, it follows that $\lambda_{R,\zeta}^*(\alpha)$ is positive, whence it is immediate to see that $\lambda_{R,\zeta}(\alpha) = \lambda_{R,\zeta}^*(\alpha) - \Lambda_\zeta(\alpha) > -\Lambda_\zeta(\alpha)$, namely,

$$-\lambda_{R,\zeta}(\alpha) < \max \{ D\alpha^2 + \nu - \mu + \mu\nu/d, d(\alpha^2 + 1) + M \}.$$

It suffices to show that

$$-\lambda_{R,\zeta}(\alpha) > \max \left\{ D\alpha^2 - \mu, d\alpha^2 + m - d\frac{\pi^2}{R^2} \right\}.$$

From Step 3 we have that $-\lambda_{R,\zeta}(\alpha)$ is non-decreasing with respect to ζ for all $\alpha \in \mathbb{R}$, it then follows that $-\lambda_{R,\zeta}(\alpha) \geq -\lambda_{R,m}(\alpha)$ for all $\alpha \in \mathbb{R}$. We claim that

$$-\lambda_{R,m}(\alpha) > \max \left\{ D\alpha^2 - \mu, d\alpha^2 + m - d\frac{\pi^2}{R^2} \right\}. \quad (3.38)$$

Inspired from [84, Proposition 3.4], we assume by contradiction that $-D\alpha^2 + \mu - \lambda_{R,m}(\alpha) \leq 0$. Denote by $(\lambda_{R,m}(\alpha), (\tilde{p}, \tilde{q}))$ the principal eigenpair of eigenvalue problem (3.30) with ζ replaced by m , then $(\lambda_{R,m}(\alpha), (\tilde{p}, \tilde{q}))$ satisfies

$$\begin{cases} -D\tilde{p}'' + 2D\alpha\tilde{p}' + (-D\alpha^2 + \mu)\tilde{p} - \nu\tilde{q}(x, 0) = \lambda_{R,m}(\alpha)\tilde{p}, & x \in \mathbb{R}, \\ -d\Delta\tilde{q} + 2d\alpha\partial_x\tilde{q} - (d\alpha^2 + m)\tilde{q} = \lambda_{R,m}(\alpha)\tilde{q}, & (x, y) \in \Omega_R, \\ -d\partial_y\tilde{q}(x, 0) + \nu\tilde{q}(x, 0) - \mu\tilde{p} = 0, & x \in \mathbb{R}, \\ \tilde{q}(x, R) = 0, & x \in \mathbb{R}, \\ \tilde{p}, \tilde{q} \text{ are } L\text{-periodic with respect to } x. \end{cases} \quad (3.39)$$

Since \tilde{p} satisfies

$$-D\tilde{p}'' + 2D\alpha\tilde{p}' + (-D\alpha^2 + \mu - \lambda_{R,m}(\alpha))\tilde{p} = \nu\tilde{q}(\cdot, 0) > 0 \text{ in } \mathbb{R}, \quad (3.40)$$

one infers that any positive constant is a subsolution of (3.40). Since \tilde{p} is L -periodic in x , one gets that \tilde{p} is identically equal to its minimum and thus \tilde{p} is a positive constant in \mathbb{R} . Then, $0 < \nu\tilde{q}(\cdot, 0) = (-D\alpha^2 + \mu - \lambda_{R,m}(\alpha))\tilde{p} \leq 0$ in \mathbb{R} . This is a contradiction. Therefore, $-D\alpha^2 + \mu - \lambda_{R,m}(\alpha) > 0$.

Next, we assume that $\lambda_{R,m}(\alpha) \geq -d\alpha^2 - m + d\frac{\pi^2}{R^2}$. We denote $w_R = \frac{\pi}{R}$, then

$$w := \sqrt{\frac{d\alpha^2 + m + \lambda_{R,m}(\alpha)}{d}} \geq w_R > 0.$$

3. Spreading speeds and pulsating fronts for a field-road model in a periodic habitat

Integrating the second equation in (3.39) with respect to x over $[0, L]$, then $\Psi(y) := \int_0^L \tilde{q}(x, y) dx$ satisfies $\Psi''(y) + w^2\Psi(y) = 0$, with $\Psi(y) > 0$ in $[0, R)$, $\Psi(R) = 0$. One gets that $\Psi(\cdot) = C \sin(w(R - \cdot))$ in $[0, R]$ for some constant $C > 0$. Since $w \geq w_R$, it is easy to see that $[0, R)$ contains at least a half period of Ψ , namely, Ψ must attain a non-positive value in $[0, R)$, which is impossible. Therefore, $\lambda_{R,m}(\alpha) < -d\alpha^2 - m + d\frac{\pi^2}{R^2}$, namely, (3.38) is proved. This completes the proof of (iv). \square

In what follows, we shall give the variational formulas for $c_{R,\pm}^*$ by linear operators approach. For simplicity of the notation, we write $\lambda_R(\alpha) := \lambda_{R,\zeta}(\alpha)$ in the sequel. We have:

Proposition 3.19. *Let $c_{R,+}^*$ and $c_{R,-}^*$ be the rightward and leftward asymptotic spreading speeds of Q_1 . Then,*

$$c_{R,+}^* = \inf_{\alpha > 0} \frac{-\lambda_R(\alpha)}{\alpha}, \quad c_{R,-}^* = \inf_{\alpha > 0} \frac{-\lambda_R(-\alpha)}{\alpha}.$$

Proof. Since $f(x, v) \leq f_v(x, 0)v$ for all $(x, y) \in \bar{\Omega}_R$ and $v \geq 0$, it follows that, for any $(u_0, v_0) \in \mathcal{K}$, the solution $(u(t, \cdot; u_0), v(t, \cdot, \cdot; v_0))$ of (3.2) is a strict subsolution of (3.28) for all $t > 0$ and $(x, y) \in \bar{\Omega}_R$. By a comparison argument, it implies that $Q_t[(u_0, v_0)] \leq L(t)[(u_0, v_0)]$ for all $t > 0$ and $(u_0, v_0) \in \mathcal{K}$. Letting $t = 1$, we have $Q_1((u_0, v_0)) \leq L(1)[(u_0, v_0)]$ for every $(u_0, v_0) \in \mathcal{K}$.

Define a linear operator \mathbb{L}_α on $\mathbb{P} = \{(u, v) \in \mathbb{C}_0^1 : (u_0, v_0) \text{ is } L\text{-periodic in } x\}$ associated with $L(1)$ by

$$\begin{aligned} \mathbb{L}_\alpha[(u_0, v_0)] &:= e^{\alpha x} \cdot L(1)[e^{-\alpha x}(u_0, v_0)] \\ &= e^{\alpha x} \cdot e^{-\alpha x} L_\alpha(1)[(u_0, v_0)] \\ &= L_\alpha(1)[(u_0, v_0)] \text{ for every } (u_0, v_0) \in \mathbb{P} \text{ and } (x, y) \in \bar{\Omega}_R. \end{aligned}$$

It then follows that $\mathbb{L}_\alpha = L_\alpha(1)$, and hence, $e^{-\lambda_R(\alpha)}$ is the principal eigenvalue of \mathbb{L}_α . Since the function $\alpha \mapsto \ln(e^{-\lambda_R(\alpha)}) = -\lambda_R(\alpha)$ is convex, using similar arguments as in [155, Theorem 2.5] and [113, Theorem 3.10(i)], we obtain that

$$c_{R,+}^* \leq \inf_{\alpha > 0} \frac{\ln(e^{-\lambda_R(\alpha)})}{\alpha} = \inf_{\alpha > 0} \frac{-\lambda_R(\alpha)}{\alpha}. \quad (3.41)$$

On the other hand, for any given $\varepsilon \in (0, 1)$, there exists $\delta > 0$ such that $f(x, v) \geq (1 - \varepsilon)f_v(x, 0)v$ for all $v \in [0, \delta]$ and $(x, y) \in \bar{\Omega}_R$. By the continuity of the solutions of (3.2) with respect to the initial conditions given in Proposition 3.16, there exists a L -periodic (in x) positive function pair $(u_1, v_1) \in \text{Int}(\mathbb{P}^+)$ satisfying $u_1 \leq U_R$ in \mathbb{R} and $v_1 \leq V_R$ in $\bar{\Omega}_R$ such that $u(t, x; u_1) \leq \nu\delta/\mu$, $v(t, x, y; v_1) \leq \delta$ for all $t \in [0, 1]$ and $(x, y) \in \bar{\Omega}_R$. By Proposition 3.13, one infers that, for all $(u_0, v_0) \in \mathcal{K}_1 := \{(u, v) \in C(\mathbb{R}) \times C(\bar{\Omega}_R) : (0, 0) \leq (u, v) \leq (u_1, v_1) \text{ in } \bar{\Omega}_R\}$,

$$u(t, \cdot; u_0) \leq u(t, \cdot; u_1) \leq \nu\delta/\mu \text{ for all } t \in [0, 1] \text{ and } x \in \mathbb{R},$$

$$v(t, \cdot, \cdot; v_0) \leq v(t, \cdot, \cdot; v_1) \leq \delta \text{ for all } t \in [0, 1] \text{ and } (x, y) \in \overline{\Omega}_R.$$

Thus, for any $(u_0, v_0) \in \mathcal{K}_1$, the solution $(u(t, \cdot; u_0), v(t, \cdot, \cdot; v_0))$ of (3.2) satisfies

$$\begin{cases} u_t - Du_{xx} = \nu v(t, x, 0) - \mu u, & t \in [0, 1], x \in \mathbb{R}, \\ v_t - d\Delta v \geq (1 - \varepsilon)f_v(x, 0)v, & t \in [0, 1], (x, y) \in \Omega_R, \\ -d\partial_y v(t, x, 0) = \mu u - \nu v(t, x, 0), & t \in [0, 1], x \in \mathbb{R}, \\ v(t, x, R) = 0, & t \in [0, 1], x \in \mathbb{R}. \end{cases}$$

Let $\{\mathbb{L}^\varepsilon(t)\}_{t \geq 0}$ be the solution semigroup generated by the following linear system:

$$\begin{cases} u_t - Du_{xx} = \nu v(t, x, 0) - \mu u, & t > 0, x \in \mathbb{R}, \\ v_t - d\Delta v = (1 - \varepsilon)f_v(x, 0)v, & t > 0, (x, y) \in \Omega_R, \\ -d\partial_y v(t, x, 0) = \mu u - \nu v(t, x, 0), & t > 0, x \in \mathbb{R}, \\ v(t, x, R) = 0, & t > 0, x \in \mathbb{R}. \end{cases}$$

Then, Proposition 3.13 implies that $\mathbb{L}^\varepsilon(t)[(u_0, v_0)] \leq Q_t[(u_0, v_0)]$ for all $t \in [0, 1]$ and $(u_0, v_0) \in \mathcal{K}_1$. In particular, $\mathbb{L}^\varepsilon(1)[(u_0, v_0)] \leq Q_1[(u_0, v_0)]$ for all $(u_0, v_0) \in \mathcal{K}_1$.

Let $\lambda_R^\varepsilon(\alpha)$ be the principal eigenvalue of the eigenvalue problem (3.30) with $f_v(x, 0)$ replaced by $(1 - \varepsilon)f_v(x, 0)$. As argued above, the concavity of $\lambda_R^\varepsilon(\alpha)$ and similar arguments as in [155, Theorem 2.4] and [113, Theorem 3.10(ii)] give rise to

$$c_{R,+}^* \geq \inf_{\alpha > 0} \frac{\ln(e^{-\lambda_R^\varepsilon(\alpha)})}{\alpha} = \inf_{\alpha > 0} \frac{-\lambda_R^\varepsilon(\alpha)}{\alpha} \text{ for all } \varepsilon \in (0, 1). \quad (3.42)$$

Combining (6.83) and (6.85), we obtain

$$\inf_{\alpha > 0} \frac{-\lambda_R^\varepsilon(\alpha)}{\alpha} \leq c_{R,+}^* \leq \inf_{\alpha > 0} \frac{-\lambda_R(\alpha)}{\alpha} \text{ for all } \varepsilon \in (0, 1).$$

Letting $\varepsilon \rightarrow 0$, thanks to the continuity of the function $\zeta \mapsto \lambda_{R,\zeta}(\alpha)$ in Proposition 3.18 (ii), we then have

$$c_{R,+}^* = \inf_{\alpha > 0} \frac{-\lambda_R(\alpha)}{\alpha}.$$

By change of variables $\widehat{u}(t, x) := u(t, -x)$ and $\widehat{v}(t, x, y) := v(t, -x, y)$, it follows that $c_{R,-}^*$ is the rightward asymptotic spreading speed of the resulting system for $(\widehat{u}, \widehat{v})$. From the lines as above, it can be derived that

$$c_{R,-}^* = \inf_{\alpha > 0} \frac{-\lambda_R(-\alpha)}{\alpha}.$$

The proposition is therefore proved. □

3. Spreading speeds and pulsating fronts for a field-road model in a periodic habitat

Lemma 3.20. $c_{R,+}^* = c_{R,-}^* > 0$.

Proof. We first prove that $c_{R,+}^* = c_{R,-}^*$. By virtue of the variational formulas obtained above, it is enough to show $\lambda_R(\alpha) = \lambda_R(-\alpha)$. Let $(\lambda_R(\alpha); (p, q))$ be the principal eigenpair of the eigenvalue problem (3.30), namely,

$$\begin{cases} -Dp'' + 2D\alpha p' + (-D\alpha^2 + \mu)p - \nu q(x, 0) = \lambda_R(\alpha)p, & x \in \mathbb{R}, \\ -d\Delta q + 2d\alpha \partial_x q - (d\alpha^2 + f_v(x, 0))q = \lambda_R(\alpha)q, & (x, y) \in \Omega_R, \\ -d\partial_y q(x, 0) + \nu q(x, 0) - \mu p = 0, & x \in \mathbb{R}, \\ q(x, R) = 0, & x \in \mathbb{R}, \\ p, q \text{ are } L\text{-periodic with respect to } x, \end{cases} \quad (3.43)$$

and let $(\lambda_R(-\alpha); (\phi, \psi))$ be the principal eigenpair of the eigenvalue problem (3.30), that is,

$$\begin{cases} -D\phi'' - 2D\alpha\phi' + (-D\alpha^2 + \mu)\phi - \nu\psi(x, 0) = \lambda_R(-\alpha)\phi, & x \in \mathbb{R}, \\ -d\Delta\psi - 2d\alpha\partial_x\psi - (d\alpha^2 + f_v(x, 0))\psi = \lambda_R(-\alpha)\psi, & (x, y) \in \Omega_R, \\ -d\partial_y\psi(x, 0) + \nu\psi(x, 0) - \mu\phi = 0, & x \in \mathbb{R}, \\ \psi(x, R) = 0, & x \in \mathbb{R}, \\ \phi, \psi \text{ are } L\text{-periodic with respect to } x. \end{cases} \quad (3.44)$$

We multiply the first equations in (3.43) and in (3.44) by ϕ and p , respectively, then we integrate the two resulting equations over $(0, L)$. By subtraction, it follows that

$$[\lambda_R(\alpha) - \lambda_R(-\alpha)] \int_0^L p\phi dx = -\nu \int_0^L (q(x, 0)\phi - \psi(x, 0)p) dx.$$

Similarly, we multiply the second equations in (3.43) and in (3.44) by ψ and q , respectively. By subtracting the integration of the two resulting equations over $S = (0, L) \times (0, R)$, one gets

$$[\lambda_R(\alpha) - \lambda_R(-\alpha)] \int_S q\psi dx dy = \mu \int_0^L (q(x, 0)\phi - \psi(x, 0)p) dx.$$

Therefore, by using the positivity of (p, q) and (ϕ, ψ) , one has

$$\operatorname{sgn}(\lambda_R(\alpha) - \lambda_R(-\alpha)) = \operatorname{sgn}\left(\int_0^L (q(x, 0)\phi - \psi(x, 0)p) dx\right) = -\operatorname{sgn}\left(\int_0^L (q(x, 0)\phi - \psi(x, 0)p) dx\right),$$

which implies that $\lambda_R(\alpha) = \lambda_R(-\alpha)$. Consequently, $c_{R,+}^* = c_{R,-}^*$.

From $\lambda_R(\alpha) = \lambda_R(-\alpha)$ and from Proposition 3.18 (iv), it is seen that the function $\alpha \mapsto -\lambda_R(\alpha)$ is convex and even in \mathbb{R} and $-\lambda_R(0) \geq m - d\pi^2/(R^2) > 0$. Thus, $-\lambda_R(\alpha) > 0$ for all $\alpha \in \mathbb{R}$, whence $c_{R,+}^* = c_{R,-}^* > 0$. \square

Proofs of Theorems 3.3 and 3.5. By Theorems 3.4, 4.3 and 4.4 in [114], as well as Lemma 3.20 above, one derives the conclusion of Theorem 3.3 with spreading speed c_R^* , as well as the existence of the non-increasing in s rightward and non-decreasing in s leftward periodic traveling waves for problem (3.2) with minimal wave speed c_R^* . To complete the proof of Theorem 3.5, it remains to show that these periodic traveling fronts are strictly monotone in s . For $c \geq c_R^*$, consider a periodic rightward traveling front of (3.2) (the case of leftward waves can be dealt with similarly), written as $(\phi_R(s, x), \psi_R(s, x, y)) = (u(\frac{x-s}{c}, x), v(\frac{x-s}{c}, x, y))$ for all $s \in \mathbb{R}$ and $(x, y) \in \overline{\Omega}_R$. Notice that $(u(t, x), v(t, x, y))$ satisfies (3.2) and (3.6), and is defined for all $t \in \mathbb{R}$ and $(x, y) \in \overline{\Omega}_R$. Since $c \geq c_R^* > 0$, the function pair (u, v) is non-decreasing in $t \in \mathbb{R}$. Then, for any $\tau > 0$, $w(t, x) = u(t + \tau, x) - u(t, x) \geq 0$, $z(t, x, y) = v(t + \tau, x, y) - v(t, x, y) \geq 0$ for all $t \in \mathbb{R}$ and $(x, y) \in \overline{\Omega}_R$. The function pair (w, z) is a classical solution to a linear problem in $\mathbb{R} \times \overline{\Omega}_R$. The strong parabolic maximum principle and the Hopf lemma, as well as the uniqueness of the corresponding Cauchy problem then imply that either (w, z) is identically $(0, 0)$ or positive everywhere in $\mathbb{R} \times [0, R)$. If $(w, z) \equiv (0, 0)$, then $(\phi_R(s - c\tau, x), \psi_R(s - c\tau, x, y)) = (\phi_R(s, x), \psi_R(s, x, y))$ for all $s \in \mathbb{R}$ and $(x, y) \in \overline{\Omega}_R$, which contradicts the limit condition (3.7) as $s \rightarrow \pm\infty$ due to $c\tau > 0$. Therefore, $w > 0$ in \mathbb{R} and $z > 0$ in $\mathbb{R} \times [0, R)$ for any $\tau > 0$. Hence, $(\phi_R(s, x), \psi_R(s, x, y))$ is decreasing in s . This completes the proof. \square

3.5 Propagation properties in the half-plane: Proofs of Theorems 3.6 and 3.8

This section is devoted to propagation properties for problem (3.1) in the half-plane. We only sketch the detailed proof in the right direction along the road, since the discussion in the left direction can be handled similarly.

3.5.1 The generalized eigenvalue problem in the half-plane

Recall from Proposition 3.18 that

$$\max \left\{ D\alpha^2 - \mu, d\alpha^2 + m - d\frac{\pi^2}{R^2} \right\} < -\lambda_R(\alpha) < \max \left\{ D\alpha^2 + \nu - \mu + \frac{\mu\nu}{d}, d(\alpha^2 + 1) + M \right\}, \quad (3.45)$$

and the function $R \mapsto -\lambda_R(\alpha)$ is increasing. For any fixed $\alpha \in \mathbb{R}$, we can take the limit as follows:

$$\lambda(\alpha) := \lim_{R \rightarrow +\infty} \lambda_R(\alpha). \quad (3.46)$$

3. Spreading speeds and pulsating fronts for a field-road model in a periodic habitat

It can be deduced from (3.45) that

$$\max \left\{ D\alpha^2 - \mu, d\alpha^2 + m \right\} \leq -\lambda(\alpha) \leq \max \left\{ D\alpha^2 + \nu - \mu + \frac{\mu\nu}{d}, d(\alpha^2 + 1) + M \right\}. \quad (3.47)$$

Since the function $\alpha \mapsto -\lambda_R(\alpha)$ is convex and continuous in \mathbb{R} and since the pointwise limit of a convex function is still convex, it follows that the function $\alpha \mapsto -\lambda(\alpha)$ is convex and continuous in \mathbb{R} . Furthermore, we have:

Theorem 3.21. *For any $\alpha \in \mathbb{R}$, let $\lambda(\alpha)$ be defined by (3.46). Then there exists a positive L -periodic (in x) function pair $(P_\alpha(x), Q_\alpha(x, y))$ associated with $\Lambda = \lambda(\alpha)$ satisfying*

$$\begin{cases} -DP_\alpha'' + 2D\alpha P_\alpha' + (-D\alpha^2 + \mu)P_\alpha - \nu Q_\alpha(x, 0) = \Lambda P_\alpha, & x \in \mathbb{R}, \\ -d\Delta Q_\alpha + 2d\alpha \partial_x Q_\alpha - (d\alpha^2 + f_v(x, 0))Q_\alpha = \Lambda Q_\alpha, & (x, y) \in \Omega, \\ -d\partial_y Q_\alpha(x, 0) + \nu Q_\alpha(x, 0) - \mu P_\alpha = 0, & x \in \mathbb{R}, \\ P_\alpha, Q_\alpha \text{ are positive and } L\text{-periodic with respect to } x, \end{cases} \quad (3.48)$$

and such that, up to some normalization,

$$P_\alpha \leq 1 \text{ in } \mathbb{R}, \quad Q_\alpha \text{ is locally bounded in } \bar{\Omega}.$$

We call $\lambda(\alpha)$ the generalized principal eigenvalue of (3.48) and (P_α, Q_α) the generalized principal eigenfunction pair associated with $\lambda(\alpha)$. Moreover, problem (3.48) admits no positive and L -periodic (in x) eigenfunction pair for any $\Lambda > \lambda(\alpha)$.

Remark 3.22. We point out here that the classical Krein-Rutman theorem cannot be applied anymore due to the noncompactness of the domain. We denote by $(P_R, Q_R) := (P_{\alpha, R}, Q_{\alpha, R})$ the principal eigenfunction pair of (3.5) in $\bar{\Omega}_R$ associated with the principal eigenvalue $\lambda_R(\alpha)$ for simplicity. As will be shown later, with the technical Lemmas 3.23–3.25, we can show that, up to normalization, $\lim_{R \rightarrow +\infty} (P_R, Q_R)$ turns out to be the generalized principal eigenfunction pair (P_α, Q_α) of (3.48) in $\bar{\Omega}$ corresponding to the generalized principal eigenvalue $\lambda(\alpha)$. The statements of Lemmas 3.23–3.25 are similar to Lemmas 3.5–3.7 in [84], however, our case is much more involved, since the heterogeneous assumption is now set on f , this does not allow us to get the nice upper estimate as in Lemma 3.6 of [84]. For the sake of completeness, we give the details below.

Lemma 3.23. *For any $R > R_0$, normalizing with $\|P_R(\cdot)\|_{L^\infty(\mathbb{R})} = 1$, there exists $C_1 > 0$ (independent of R) such that*

$$\|Q_R(\cdot, 0)\|_{L^\infty(\mathbb{R})} > C_1.$$

Proof. If the conclusion is not true, we assume that there exists a sequence $(R_k)_{k \in \mathbb{N}}$ satisfying $R_k \rightarrow +\infty$ such that $\|Q_{R_k}(\cdot, 0)\|_{L^\infty(\mathbb{R})} \rightarrow 0$ and $\|P_{R_k}\|_{L^\infty(\mathbb{R})} = 1$. Since (P_{R_k}, Q_{R_k}) is L -periodic in x , we assume with no loss of generality that $x_k \in [0, L]$ such that $P(x_k) = 1$.

Since $(P_{R_k})_{k \in \mathbb{N}}$ and $(Q_{R_k}(\cdot, 0))_{k \in \mathbb{N}}$ are uniformly bounded, by the Arzelà-Ascoli Theorem, up to extraction of a subsequence, one has $P_{R_k} \rightarrow P_\infty \geq 0$ and $Q_{R_k}(\cdot, 0) \rightarrow 0$ as $k \rightarrow +\infty$. Moreover, there exists $x_\infty \in [0, L]$ such that, up to a subsequence, $x_k \rightarrow x_\infty$ as $k \rightarrow +\infty$. Passing to the limit $k \rightarrow +\infty$ in the first equation of eigenvalue problem (3.5) satisfied by (P_{R_k}, Q_{R_k}) in $\overline{\Omega}_{R_k}$ implies

$$-DP_\infty'' + 2D\alpha P_\infty' + (-D\alpha^2 + \mu)P_\infty = \lambda(\alpha)P_\infty \text{ in } \mathbb{R}.$$

Moreover, P_∞ is L -periodic in x and $P_\infty(x_\infty) = 1$. The strong maximum principle implies $P_\infty > 0$ in \mathbb{R} . Thus, P_∞ is a positive constant. Hence, $\lambda(\alpha) = -D\alpha^2 + \mu$. This implies $\lambda_R(\alpha) \geq \lambda(\alpha) = -D\alpha^2 + \mu$, which contradicts (3.45). Consequently, Lemma 3.23 is proved. \square

Lemma 3.24. *For any $R > R_0$, assume that $\|Q_R(\cdot, 0)\|_{L^\infty(\mathbb{R})} = 1$, then $Q_R(x, y)$ is locally bounded as $R \rightarrow +\infty$ by some positive constant (independent of R).*

Proof. For convenience, let us introduce some new notations. For $n > R_0$ large enough, we denote by $(\lambda_n(\alpha); (P_n, Q_n))$ the principal eigenpair of (3.5) in $\overline{\Omega}_n = \mathbb{R} \times [0, n]$ with normalization $\|Q_n(\cdot, 0)\|_{L^\infty(\mathbb{R})} = 1$. Then, one has to show that, for any compact set $K \subset \overline{\Omega}$, there holds

$$\sup_n (\max_{K \cap \overline{\Omega}_n} Q_n(x, y)) < +\infty. \quad (3.49)$$

To prove this, we first claim that $\|P_n\|_{L^\infty(\mathbb{R})} \leq C_0$ for some constant $C_0 > 0$. Assume by contradiction that $\|P_n\|_{L^\infty(\mathbb{R})}$ is unbounded, then we choose a sequence $(P_n)_{n \in \mathbb{N}}$ such that $\|P_n\|_{L^\infty(\mathbb{R})} \rightarrow +\infty$ as $n \rightarrow +\infty$. By renormalization, it follows that $\|P_n\|_{L^\infty(\mathbb{R})} = 1$ while $\|Q_n(\cdot, 0)\|_{L^\infty(\mathbb{R})} \rightarrow 0$. This contradicts the conclusion of Lemma 3.23. Our claim is thereby achieved. It then follows from the boundary condition $-d\partial_y Q_n(\cdot, 0) = \mu P_n(\cdot) - \nu Q_n(\cdot, 0)$ that $\|\partial_y Q_n(\cdot, 0)\|_{L^\infty(\mathbb{R})} \leq (\mu C_0 + \nu)/d$. Assume now that (3.49) is not true. Then, there exist a compact subset $K \subset \overline{\Omega}$ and a sequence $(x_n, y_n)_{n \in \mathbb{N}}$ in $K \cap \overline{\Omega}_n$ so that $Q_n(x_n, y_n) = \max_{K \cap \overline{\Omega}_n} Q_n > n$. Then we are able to find a larger compact set containing K such that this assumption is still satisfied. Therefore, without loss of generality we take $K = \overline{B_\rho^+((0, 0))}$ with radius ρ large. Therefore, up to extraction of some subsequence, $x_n \rightarrow x_\infty \in [-\rho, \rho]$, $y_n \rightarrow y_\infty \in [0, +\infty)$ as $n \rightarrow +\infty$, thanks to the boundedness of $(y_n)_{n \in \mathbb{N}}$. It follows that either $y_\infty > 0$ or $y_\infty = 0$. By setting

$$w_n(x, y) := \frac{Q_n(x, y)}{Q_n(x_n, y_n)} \text{ in } K \cap \overline{\Omega}_n,$$

one has $0 < w_n \leq 1$ in $K \cap \overline{\Omega}_n$ and $w_n(\cdot, 0) < \frac{1}{n}$ in $[-\rho, \rho]$ for all n large enough. In particular,

3. Spreading speeds and pulsating fronts for a field-road model in a periodic habitat

$w_n(x_n, y_n) = 1$. It can be deduced that the function w_n satisfies

$$\begin{cases} -d\Delta w_n + 2d\alpha\partial_x w_n - (d\alpha^2 + f_v(x, 0) + \lambda_n(\alpha))w_n = 0, & \text{in } K \cap \overline{\Omega}_n, \\ -d\partial_y w_n(x, 0) = \mu \frac{P_n(x)}{Q_n(x_n, y_n)} - \nu w_n(x, 0), & \text{in } [-\rho, \rho]. \end{cases}$$

From standard elliptic estimates up to the boundary, the positive function w_n converges, up to extraction of some subsequence, to a classical solution $w_\infty \in [0, 1]$ of

$$\begin{cases} -d\Delta w_\infty + 2d\alpha\partial_x w_\infty - (d\alpha^2 + f_v(x, 0) + \lambda(\alpha))w_\infty = 0, & \text{in } K \cap \overline{\Omega}, \\ -d\partial_y w_\infty(x, 0) + \nu w_\infty(x, 0) = 0, & \text{in } [-\rho, \rho]. \end{cases}$$

Moreover, $w_\infty(\cdot, 0) = 0$ in $[-\rho, \rho]$ and $w_\infty(x_\infty, y_\infty) = 1$. Therefore, the case that $y_\infty = 0$ is impossible. Assume now that $y_\infty > 0$. By using the Harnack inequality up to the boundary, there exists a point (x', y') in the neighborhood of (x_∞, y_∞) belonging to $(K \cap \overline{\Omega})^\circ$ such that $w_\infty(x', y') \geq \frac{1}{2}$. Then, the strong maximum principle implies that $w_\infty > 0$ in $(K \cap \overline{\Omega})^\circ$. Since $w_\infty(\cdot, 0) = 0$ in $[-\rho, \rho]$, one infers from the boundary condition that $\partial_y w_\infty(\cdot, 0) = 0$ in $[-\rho, \rho]$. This is a contradiction with the Hopf lemma. This completes the proof of Lemma 3.24. \square

Lemma 3.25. *For any $R > R_0$, normalizing with $\|P_R(\cdot)\|_{L^\infty(\mathbb{R})} = 1$, there is $C_2 > 0$ (independent of R) such that*

$$\|Q_R(\cdot, 0)\|_{L^\infty(\mathbb{R})} \leq C_2.$$

Proof. If the statement is not true, by suitable renormalization we assume that there is a sequence $(R_n)_{n \in \mathbb{N}}$ satisfying $R_n \rightarrow +\infty$ such that $\|Q_{R_n}(\cdot, 0)\|_{L^\infty(\mathbb{R})} = 1$ and such that $\|P_{R_n}(\cdot)\|_{L^\infty(\mathbb{R})} \rightarrow 0$. Without loss of generality, we assume that $x_n \in [0, L]$ for all $n \in \mathbb{N}$, such that $Q_{R_n}(x_n, 0) = 1$. Therefore, there is $x_\infty \in [0, L]$ such that, up to some subsequence, $x_n \rightarrow x_\infty$ as $n \rightarrow +\infty$. Since $(P_{R_n})_{n \in \mathbb{N}}$ and $(Q_{R_n}(\cdot, 0))_{n \in \mathbb{N}}$ are uniformly bounded in $L^\infty(\mathbb{R})$, it follows from Lemma 3.24 and from standard elliptic estimates up to the boundary that the function pair (P_{R_n}, Q_{R_n}) converges as $n \rightarrow +\infty$, up to extraction of some subsequence, locally uniformly in $\overline{\Omega}$ to (P_∞, Q_∞) . In particular, $P_\infty \equiv 0$ in \mathbb{R} and $Q_\infty(x_\infty, 0) = 1$. Moreover, P_∞ satisfies

$$-DP_\infty'' + 2D\alpha P_\infty' + (-D\alpha^2 + \mu)P_\infty - \nu Q_\infty(\cdot, 0) = \lambda(\alpha)P_\infty \text{ in } \mathbb{R}.$$

Then, it is easily derived from above equation that $Q_\infty(\cdot, 0) \equiv 0$ in \mathbb{R} , which contradicts $Q_\infty(x_\infty, 0) = 1$. The proof of this lemma is thereby complete. \square

Proof of Theorem 3.21. By elliptic estimates and Lemmas 3.23–3.25, the eigenfunction pair (P_R, Q_R) converges locally uniformly in $\overline{\Omega}$ as $R \rightarrow +\infty$ to a nonnegative and L -periodic (in x) function pair (P_α, Q_α) solving the generalized eigenvalue problem (3.48) in the half-plane $\overline{\Omega}$ associated with the generalized principal eigenvalue $\lambda(\alpha)$. Moreover, up to normalization, it follows that $P_\alpha \leq 1$ in \mathbb{R} and Q_α is locally bounded in $\overline{\Omega}$. By the strong maximum principle and the Hopf Lemma, we further derive that (P_α, Q_α) is positive in $\overline{\Omega}$.

Assume that Λ corresponds to a positive and L -periodic (in x) eigenfunction pair (P, Q) such that the generalized eigenvalue problem (3.48) is satisfied. By reasoning as in the proof of Proposition 3.18 (iii), it follows that $\Lambda < \lambda_R(\alpha)$ for any $R > R_0$, which reveals $\Lambda \leq \lambda(\alpha)$ by taking $R \rightarrow +\infty$. \square

3.5.2 Spreading speeds and pulsating fronts in the half-plane

This subsection is devoted to the proofs of Theorems 3.6 and 3.8. We start with variational characterization of the rightward and leftward asymptotic spreading speeds c_{\pm}^* by using the generalized principal eigenvalue constructed in the preceding subsection. Define

$$c_+^* := \inf_{\alpha > 0} \frac{-\lambda(\alpha)}{\alpha}, \quad c_-^* := \inf_{\alpha > 0} \frac{-\lambda(-\alpha)}{\alpha}.$$

Thanks to (3.47), it is noticed that $c_+^* \in [2\sqrt{dm}, +\infty)$ is well-defined. Moreover, we point out that, from the definitions of $\lambda(\pm\alpha)$ and of c_{\pm}^* and from the property that $\lambda_R(\alpha) = \lambda_R(-\alpha)$ for all $\alpha \in \mathbb{R}$ (for any $R > R_0$) shown in the proof of Lemma 3.20, it is obvious to see that $c_+^* = c_-^*$. In what follows, we denote $c^* := c_+^* = \inf_{\alpha > 0} -\lambda(\alpha)/\alpha > 0$.

Lemma 3.26. *There holds $c_R^* < c^*$ and $c_R^* \rightarrow c^*$ as $R \rightarrow +\infty$.*

Proof. Since the function $R \mapsto -\lambda_R(\alpha)$ is increasing for all $\alpha \in \mathbb{R}$, one has $-\lambda_R(\alpha) < -\lambda(\alpha)$ for all $\alpha \in \mathbb{R}$. This implies

$$\frac{-\lambda_R(\alpha)}{\alpha} < \frac{-\lambda(\alpha)}{\alpha} \text{ for all } \alpha > 0.$$

Furthermore,

$$\inf_{\alpha > 0} \frac{-\lambda_R(\alpha)}{\alpha} < \inf_{\alpha > 0} \frac{-\lambda(\alpha)}{\alpha},$$

which implies

$$0 < c_R^* < c^*. \tag{3.50}$$

It remains to prove that $c_R^* \rightarrow c^*$ as $R \rightarrow +\infty$. Since the functions $\alpha \mapsto -\lambda_R(\alpha)$ and $\alpha \mapsto -\lambda(\alpha)$ are convex and continuous in \mathbb{R} , one has $\alpha \mapsto -\lambda_R(\alpha)/\alpha$ and $\alpha \mapsto -\lambda(\alpha)/\alpha$ are continuous for all $\alpha \in (0, +\infty)$. Since $-\lambda_R(\alpha)/\alpha$ increasingly converges to $-\lambda(\alpha)/\alpha$ as $R \rightarrow +\infty$ for each $\alpha \in (0, +\infty)$, the Dini's Theorem (see, e.g., [141, Theorem 7.13]) implies that

$$\frac{-\lambda_R(\alpha)}{\alpha} \rightarrow \frac{-\lambda(\alpha)}{\alpha} \text{ as } R \rightarrow +\infty \text{ uniformly in } \alpha \in (0, +\infty).$$

On the other hand, it is seen from (3.45) and (3.47) that both $-\lambda_R(\alpha)/\alpha$ and $-\lambda(\alpha)/\alpha$ tend

3. Spreading speeds and pulsating fronts for a field-road model in a periodic habitat

to infinity as $\alpha \rightarrow 0^+$ and as $\alpha \rightarrow +\infty$. One then concludes that

$$\inf_{\alpha>0} \frac{-\lambda_R(\alpha)}{\alpha} \rightarrow \inf_{\alpha>0} \frac{-\lambda(\alpha)}{\alpha} \quad \text{as } R \rightarrow +\infty.$$

That is, $c_R^* \rightarrow c^*$ as $R \rightarrow +\infty$. The proof is thereby complete. \square

Proof of Theorem 3.6. (i) We first construct the upper bound in the rightward propagation. Let (u, v) be the solution of (3.1) with nonnegative, bounded, continuous and compactly supported initial condition $(u_0, v_0) \not\equiv (0, 0)$. We need to show

$$\lim_{t \rightarrow +\infty} \sup_{x \geq ct, 0 \leq y \leq A} |(u(t, x), v(t, x, y))| = 0 \quad \text{for all } c > c^*, \quad (3.51)$$

For any $c > c^*$, choose $c' \in [c^*, c)$ and $\alpha > 0$ such that $-\lambda(\alpha) = \alpha c'$. Let $(\lambda(\alpha); (P_\alpha, Q_\alpha))$ be the generalized principal eigenpair of (3.48) derived in Theorem 3.21. Since (u_0, v_0) is compactly supported, one infers that, for some $\gamma > 0$, $\gamma e^{-\alpha(x-c't)}(P_\alpha(x), Q_\alpha(x, y))$ lies above (u_0, v_0) at time $t = 0$. Thanks to the KPP assumption, one further deduces that $\gamma e^{-\alpha(x-c't)}(P_\alpha(x), Q_\alpha(x, y))$ is an exponential supersolution of the Cauchy problem (3.1) and $\gamma e^{-\alpha(x-c't)}(P_\alpha(x), Q_\alpha(x, y)) \geq (u(t, x), v(t, x, y))$ for all $t \geq 0$ and $(x, y) \in \bar{\Omega}$ by Proposition 6.25. It follows that, for any $A > 0$,

$$\sup_{x \geq ct, 0 \leq y \leq A} (u(t, x), v(t, x, y)) \leq \sup_{x \geq ct, 0 \leq y \leq A} \gamma e^{-\alpha(c-c')t}(P_\alpha(x), Q_\alpha(x, y)),$$

whence, by Theorem 3.21 and by passing to the limit $t \rightarrow +\infty$, the formula (3.51) is proved.

(ii) Let us prove the lower bound (3.9). Choose any $c \in (0, c^*)$. Let (u, v) be the solution of (3.1) with nonnegative, nontrivial, bounded and continuous initial condition $(u_0, v_0) < (\nu/\mu, 1)$. Thanks to (3.26), we know that $(U_B(x), V_B(x, y))$ increasingly converges to $(\nu/\mu, 1)$ as $B \rightarrow +\infty$ uniformly in x and locally uniformly in y . Since $(u_0, v_0) < (\nu/\mu, 1)$ in $\bar{\Omega}$, for $B > R_0$ sufficiently large, there is a smooth cut-off function $\chi^B : [0, +\infty) \mapsto [0, 1]$ satisfying $\chi^B(\cdot) = 1$ in $[0, B-1]$ and $\chi^B(\cdot) = 0$ in $[B, +\infty)$, such that $(0, 0) \leq (u_0, \chi^B v_0) \leq (U_B, V_B)$ in $\bar{\Omega}_B$. Let (u_B, v_B) be the solution to the Cauchy problem (3.2) in $\bar{\Omega}_B$ with initial datum $(u_0, \chi^B v_0)$ and let (U_B, V_B) be the associated unique nontrivial stationary solution of (3.2). By Lemma 3.26, up to increasing B , the asymptotic spreading speed c_B^* of the solution (u_B, v_B) to (3.2) in $\bar{\Omega}_B$ can be very close to c^* , say $c_B^* \sim c^*$, such that $c < c_B^* < c^*$. From Theorem 3.3, one derives

$$\lim_{t \rightarrow +\infty} \inf_{0 \leq x \leq ct, y \in [0, B]} (u_B(t, x), v_B(t, x, y)) = (U_B(x), V_B(x, y)),$$

due to $0 < c < c_B^*$. Notice that (u, v) is a strict supersolution to problem (3.2) with initial datum $(u_0, \chi^B v_0)$ in $\bar{\Omega}_B$, Proposition 3.13 yields $(u(t, x), v(t, x, y)) > (u_B(t, x), v_B(t, x, y))$ for

3.5. Propagation properties in the half-plane: Proofs of Theorems 3.6 and 3.8

all $t > 0$ and $(x, y) \in \overline{\Omega}_B$. Thus, for all $0 < A \leq B$, it follows that

$$(U_B(x), V_B(x, y)) \leq \lim_{t \rightarrow +\infty} \inf_{0 \leq x \leq ct, y \in [0, A]} (u(t, x), v(t, x, y)) \leq (\nu/\mu, 1).$$

Passing to the limit $B \rightarrow +\infty$ together with Proposition 3.17 (ii) implies that, for any $A > 0$,

$$\lim_{t \rightarrow +\infty} \inf_{0 \leq x \leq ct, 0 \leq y \leq A} (u(t, x), v(t, x, y)) = (\nu/\mu, 1).$$

The proof of Theorem 3.6 is thereby complete. □

Finally, we prove Theorem 3.8 in the right direction, that is, problem (3.1) admits rightward pulsating fronts if and only if $c \geq c^*$. The proof is based on an asymptotic method.

Proof of Theorem 3.8. Fix $c \geq c^*$, one infers from (3.50) that $c > c_R^*$ for any $R > R_0$. It follows from Theorem 3.5 that the truncated problem (3.2) admits a rightward pulsating traveling front $(u_R(t, x), v_R(t, x, y)) = (\phi_R(x - ct, x), \psi_R(x - ct, x, y))$ with wave speed c in the strip $\overline{\Omega}_R$ connecting (U_R, V_R) and $(0, 0)$. Moreover, the profile $(\phi_R(s, x), \psi_R(s, x, y))$ is decreasing in s and L -periodic in x . Consider a sequence $(R_n)_{n \in \mathbb{N}}$ such that $R_n \rightarrow +\infty$ as $n \rightarrow +\infty$. Denote by $(\phi_{R_n}(s, x), \psi_{R_n}(s, x, y))$ the sequence of the rightward pulsating traveling fronts of (3.2) with speed c and by (U_{R_n}, V_{R_n}) the corresponding nontrivial steady states of (3.2) in the strips $\overline{\Omega}_{R_n}$. One has

$$\begin{aligned} \phi_{R_n}(-\infty, x) &= U_{R_n}(x), \quad \phi_{R_n}(+\infty, x) = 0, \\ \psi_{R_n}(-\infty, x, y) &= V_{R_n}(x, y), \quad \psi_{R_n}(+\infty, x, y) = 0, \end{aligned}$$

uniformly in $(x, y) \in \overline{\Omega}_{R_n}$. Moreover, it follows from Proposition 3.17 that $0 < U_{R_n} < \nu/\mu$ in \mathbb{R} , $0 < V_{R_n} < 1$ in $\mathbb{R} \times [0, R)$. By the limiting property in Proposition 3.17 (ii), one can assume, without loss of generality, that $\frac{4\nu}{5\mu} < U_{R_n}(\cdot) < \frac{\nu}{\mu}$ in \mathbb{R} for each $n \in \mathbb{N}$. Then due to the monotonicity and continuity of the function $s \mapsto \phi_{R_n}(s, \cdot)$, there is a unique $s_n \in \mathbb{R}$ such that

$$\max_{x \in \mathbb{R}} \phi_{R_n}(s_n, \cdot) = \max_{x \in [0, L]} \phi_{R_n}(s_n, \cdot) = \frac{\nu}{2\mu}.$$

Set $(\phi_n(s, x), \psi_n(s, x, y)) := (\phi_{R_n}(s + s_n, x), \psi_{R_n}(s + s_n, x, y))$. Since

$$\left(u_n\left(\frac{x-s}{c}, x\right), v_n\left(\frac{x-s}{c}, x, y\right) \right) = (\phi_n(s, x), \psi_n(s, x, y)),$$

by standard parabolic estimates, the sequence $((u_n, v_n))_{n \in \mathbb{N}}$ converges, up to extraction of a subsequence, locally uniformly to a classical solution $(u(\frac{x-s}{c}, x), v(\frac{x-s}{c}, x, y)) = (\phi(s, x), \psi(s, x, y))$

3. Spreading speeds and pulsating fronts for a field-road model in a periodic habitat

of (3.1) satisfying the normalization condition

$$\max_{x \in \mathbb{R}} \phi(0, \cdot) = \max_{x \in [0, L]} \phi(0, \cdot) = \frac{\nu}{2\mu}.$$

Moreover, the profile $(\phi(s, x), \psi(s, x, y))$ is non-increasing in s and L -periodic in x such that

$$\begin{aligned} \phi(-\infty, x) &= \nu/\mu, \quad \phi(+\infty, x) = 0, \\ \psi(-\infty, x, y) &= 1, \quad \psi(+\infty, x, y) = 0, \end{aligned}$$

uniformly in $x \in \mathbb{R}$ and locally uniformly in $y \in [0, +\infty)$.

Now, let us show the monotonicity of $(\phi(s, x), \psi(s, x, y))$ in s . Since the pulsating front $(u(t, x), v(t, x, y)) = (\phi(x - ct, x), \psi(x - ct, x, y))$ propagates with speed $c \geq c^* > 0$, it follows that $u_t \geq 0$ for $t \in \mathbb{R}$ and $x \in \mathbb{R}$, $v_t \geq 0$ for $t \in \mathbb{R}$ and $(x, y) \in \bar{\Omega}$. Notice also that $(u(t, x), v(t, x, y))$ is a global classical solution of problem (3.1), whence $z = v_t$ is a global classical solution of $z_t = d\Delta z + f_v(x, v)z$ for $t \in \mathbb{R}$ and $(x, y) \in \Omega$ with $z \geq 0$. From the strong parabolic maximum principle, it follows that $z > 0$ or $z \equiv 0$ for $t \in \mathbb{R}$ and $(x, y) \in \Omega$. That is, $v_t > 0$ or $v_t \equiv 0$ for $t \in \mathbb{R}$ and $(x, y) \in \Omega$. The latter case is impossible, otherwise one would derive from $v_t \equiv 0$ that either $v \equiv 0$ or $v \equiv 1$ for $t \in \mathbb{R}$ and $(x, y) \in \Omega$. This is a contradiction with the limiting behavior of the pulsating fronts. Therefore, $v_t > 0$ for $t \in \mathbb{R}$ and $(x, y) \in \Omega$ and by continuity $v_t > 0$ for $t \in \mathbb{R}$ and $(x, y) \in \bar{\Omega}$. Likewise, one infers that $u_t > 0$ for $t \in \mathbb{R}$ and $x \in \mathbb{R}$. Hence, the rightward traveling fronts $(\phi(s, x), \psi(s, x, y))$ are decreasing in s .

Assume that there exists a rightward pulsating traveling front $(\phi(x - ct, x), \psi(x - ct, x, y))$ of (3.1) with speed $c > 0$. Then, one infers from Theorem 3.6 that, for any $c' \in [0, c^*)$ and for any $B > 0$,

$$\lim_{t \rightarrow +\infty} \sup_{0 < x \leq c't, y \in [0, B]} |(\phi(x - ct, x), \psi(x - ct, x, y)) - (\nu/\mu, 1)| = 0.$$

In particular, for any $c' \in [0, c^*)$ and for any $B > 0$, taking $x = c't$ and $y \in [0, B]$, there holds

$$\lim_{t \rightarrow +\infty} \phi((c' - c)t, c't) = \nu/\mu, \quad \lim_{t \rightarrow +\infty} \psi((c' - c)t, c't, y) = 1.$$

From the limiting condition (3.10), it follows that $c' < c$ for all $c' \in [0, c^*)$. Consequently, one gets $c^* \leq c$. This implies the non-existence of rightward pulsating traveling fronts with speed $0 < c < c^*$. \square

Chapter 4

On some model problem for the propagation of interacting species in a special environment¹

4.1 Introduction and notation

It has been observed in diffusion or propagation problems that the topography of the environment is playing a crucial role. A new evolution model of biological invasions in two dimensional environment was introduced in [30] in 2013 where the plane is divided in a line “the road” and its complement “the field”. It is assumed that the population in the field is governed by a logistic growth which leads to a KPP type reaction term $f(v)$ in the field while a more general reaction $g(u)$ is set on the road. Moreover, exchange of population is assumed to take place between the road and the field. Let us remark that this model is motivated by empirical observations that the roads are not only essential for human beings but also can be useful for other species. One can easily imagine that mosquitoes could be interested in socialising with human beings along a road but many other situations seem to have occurred due to this element of civilisation. Later, new features, such as transport and reaction terms on the road, were taken into consideration in [31] and traveling waves, spreading and extinction was studied in [33]. Afterwards, the original model in a strip with Dirichlet homogeneous boundary condition on the other part of the boundary of the field was analyzed in [152]. The model was recently generalized to higher dimension in [140]. Specifically, the Fisher-KPP type reaction-diffusion equation is set in an unbounded cylinder in \mathbb{R}^{N+1} coupled with a diffusion equation on the boundary of the cylinder where the exchanges of populations occur as well and particularly, when $N = 1$, this situation models two parallel roads bounding a field described as a strip. The interest of the references above is the pop-

¹This is a joint work with Michel Chipot, published in *Discrete & Continuous Dynamical Systems*.

4. Elliptic problem of the field-road model

ulation dynamics and propagation phenomena with respect to different diffusion assumption a priori from an evolutionary point of view, especially, to understand the effect of the road with fast diffusion on the spreading of species in a homogeneous environment. In this note, we consider an elliptic problem where the living space of our species consists in a field and one or several roads that we will assume to be unidimensional. We will also assume the roads to be straight but several extensions can be addressed very easily with our approach. On each domain -field or road- we will consider nonlinear diffusion equations which include for instance the Fisher-KPP types. The interaction with the populations is modeled by a particular flux condition (see for instance [30, 31, 140, 152] and the set of equation below).

Let Ω_ℓ be the open set of \mathbb{R}^2 , defined for $\ell, L > 0$ as

$$\Omega_\ell = (-\ell, \ell) \times (0, L).$$

We denote by Γ_0 the part of the boundary of Ω_ℓ located on the x_1 -axis i.e.

$$\Gamma_0 = (-\ell, \ell) \times \{0\}$$

and by Γ_1 the rest of the boundary that is to say

$$\Gamma_1 = \partial\Omega_\ell \setminus \Gamma_0.$$

When convenient we will identify Γ_0 to $(-\ell, \ell)$. In this setting Ω_ℓ stands for a field and Γ_0 for a portion of a road.

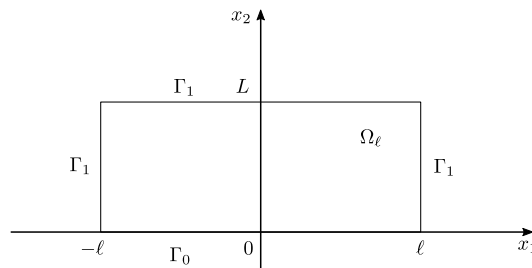

Figure 9: The domain Ω_ℓ for one-road problem

Set

$$V = \{v \in H^1(\Omega_\ell) \mid v = 0 \text{ on } \Gamma_1\}.$$

We would like to find a solution to the problem

$$\begin{cases} -D\Delta v = f(v) \text{ in } \Omega_\ell, \\ v = 0 \text{ on } \Gamma_1, \quad D\frac{\partial v}{\partial n} = \mu u - \nu v \text{ on } \Gamma_0, \\ -D'u'' + \mu u = g(u) + \nu v \text{ on } \Gamma_0, \\ u = 0 \text{ on } \partial\Gamma_0 = \{-\ell, \ell\}. \end{cases}$$

(n denotes the outward unit normal to Ω_ℓ).

In the weak form we would like to find a couple (u, v) such that

$$\begin{cases} (u, v) \in H_0^1(\Gamma_0) \times V, \\ \int_{\Omega_\ell} D\nabla v \cdot \nabla \varphi \, dx + \int_{\Gamma_0} \nu v(x_1, 0) \varphi \, dx_1 \\ = \int_{\Omega_\ell} f(v) \varphi \, dx + \int_{\Gamma_0} \mu u \varphi \, dx_1 \quad \forall \varphi \in V, \\ \int_{\Gamma_0} D'u' \psi' + \mu u \psi \, dx_1 = \int_{\Gamma_0} \nu v(x_1, 0) \psi \, dx_1 \\ + \int_{\Gamma_0} g(u) \psi \, dx_1 \quad \forall \psi \in H_0^1(\Gamma_0). \end{cases} \quad (4.1)$$

Here we assume that

$$D, D', m, \mu, \nu \text{ are positive constants,}$$

such that

$$m \geq \frac{\nu}{\mu}. \quad (4.2)$$

f, g are Lipschitz continuous functions i.e. such that for some positive constants L_f, L_g it holds

$$|f(x) - f(y)| \leq L_f |x - y|, \quad |g(x) - g(y)| \leq L_g |x - y| \quad \forall x, y \in \mathbb{R}. \quad (4.3)$$

Note that this implies that for $\lambda \geq L_f$ (respectively $\eta \geq L_g$) the functions

$$x \rightarrow \lambda x - f(x), \quad \eta x - g(x) \quad (4.4)$$

are nondecreasing. In addition we will assume

$$f(0) = f(1) = 0, \quad f > 0 \text{ on } (0, 1), \quad f \leq 0 \text{ on } (1, +\infty). \quad (4.5)$$

$$g(0) = 0, \quad g(m) \leq 0. \quad (4.6)$$

One should remark that under the assumptions above, $(0, 0)$ is a solution to (4.1). We are interested in finding a nontrivial solution to the problem (4.1). For the notation and the usual properties on Sobolev spaces we refer to [53], [50], [56], [73], [83]. We will also consider some extension in the case of a two-road problem which consists of three coupled equations

4. Elliptic problem of the field-road model

with two interaction conditions on the upper- and lower- boundaries. Finally, we will address the case of an unbounded setting for the one-road problem.

4.2 Preliminary results

Lemma 4.1. *Suppose that w is a measurable function on Γ_0 such that*

$$0 \leq w \leq m.$$

Then under the assumptions above the problem

$$\begin{cases} v \in V, \\ \int_{\Omega_\ell} D\nabla v \cdot \nabla \varphi \, dx + \int_{\Gamma_0} \nu v(x_1, 0) \varphi(x_1, 0) \, dx_1 \\ = \int_{\Omega_\ell} f(v) \varphi \, dx + \int_{\Gamma_0} \mu w \varphi \, dx_1 \quad \forall \varphi \in V, \end{cases} \quad (4.7)$$

possesses a minimal and a maximal solution with values in $[0, \frac{\mu}{\nu}m]$.

Proof. Let us remark first that any nonnegative solution to (4.7) takes its values in $[0, \frac{\mu}{\nu}m]$. Indeed, if v is solution to (4.7) taking as test function $\varphi = (v - k)^+$, $k = \frac{\mu}{\nu}m \geq 1$ one gets

$$\begin{aligned} \int_{\Omega_\ell} D|\nabla(v - k)^+|^2 \, dx &= \int_{\Omega_\ell} D\nabla(v - k) \cdot \nabla(v - k)^+ \, dx = \int_{\Omega_\ell} D\nabla v \cdot \nabla(v - k)^+ \, dx \\ &= \int_{\Omega_\ell} f(v)(v - k)^+ \, dx + \int_{\Gamma_0} \{\mu w - \nu v(x_1, 0)\}(v - k)^+ \, dx_1 \\ &\leq \int_{\Gamma_0} \{\mu w - \nu v(x_1, 0)\}(v - k)^+ \, dx_1 \leq 0, \end{aligned}$$

since on the set where $v \geq k$ one has $v \geq \frac{\mu}{\nu}m$ and $\mu w - \nu v(x_1, 0) \leq \mu w - \mu m \leq 0$.

Next let us note that 0 is a subsolution to (4.7). Indeed this follows trivially from

$$\int_{\Omega_\ell} D\nabla 0 \cdot \nabla \varphi \, dx + \int_{\Gamma_0} \nu 0 \varphi \, dx_1 \leq \int_{\Omega_\ell} f(0) \varphi \, dx + \int_{\Gamma_0} \mu w \varphi \, dx_1 \quad \forall \varphi \in V, \varphi \geq 0.$$

On the other hand, for $\varphi \in V$, $\varphi \geq 0$, one has also for $k = \frac{\mu}{\nu}m$, since $k \geq 1$

$$\int_{\Omega_\ell} D\nabla k \cdot \nabla \varphi \, dx + \int_{\Gamma_0} \nu k \varphi \, dx_1 \geq \int_{\Omega_\ell} f(k) \varphi \, dx + \int_{\Gamma_0} \mu w \varphi \, dx_1$$

and the function constant equal to $k = \frac{\mu}{\nu}m$ is a supersolution to (4.7).

For $z \in L^2(\Omega_\ell)$ we denote by $y = S(z)$ the solution to

$$\begin{cases} y \in V, \\ \int_{\Omega_\ell} D\nabla y \cdot \nabla \varphi \, dx + \int_{\Omega_\ell} \lambda y \varphi \, dx + \int_{\Gamma_0} \nu y(x_1, 0) \varphi \, dx_1 \\ = \int_{\Omega_\ell} f(z) \varphi \, dx + \int_{\Omega_\ell} \lambda z \varphi \, dx + \int_{\Gamma_0} \mu w \varphi \, dx_1 \quad \forall \varphi \in V, \end{cases} \quad (4.8)$$

where we have chosen $\lambda \geq L_f$. Note that the existence of a unique solution y to the problem above is an immediate consequence of the Lax-Milgram theorem.

First we claim that the mapping S is continuous from $L^2(\Omega_\ell)$ into itself. Indeed setting $y' = S(z')$ one has by subtraction of the equations satisfied by y and y'

$$\begin{aligned} \int_{\Omega_\ell} D\nabla(y - y') \cdot \nabla \varphi \, dx + \int_{\Omega_\ell} \lambda(y - y') \varphi \, dx + \int_{\Gamma_0} \nu(y - y') \varphi \, dx_1 \\ = \int_{\Omega_\ell} \{f(z) - f(z')\} \varphi \, dx + \int_{\Omega_\ell} \lambda(z - z') \varphi \, dx \quad \forall \varphi \in V. \end{aligned} \quad (4.9)$$

Taking $\varphi = y - y'$ one derives easily

$$\begin{aligned} \lambda \int_{\Omega_\ell} |y - y'|^2 \, dx &\leq \int_{\Omega_\ell} |f(z) - f(z')| |y - y'| \, dx + \lambda \int_{\Omega_\ell} |z - z'| |y - y'| \, dx \\ &\leq (L_f + \lambda) \int_{\Omega_\ell} |z - z'| |y - y'| \, dx. \end{aligned}$$

By the Cauchy-Schwarz inequality we obtain then

$$|S(z) - S(z')|_{2, \Omega_\ell} \leq \frac{L_f + \lambda}{\lambda} |z - z'|_{2, \Omega_\ell}$$

which shows the continuity of the mapping S ($|\cdot|_{2, \Omega_\ell}$ denotes the usual $L^2(\Omega_\ell)$ -norm).

We show now that the mapping S is monotone. Indeed suppose that $z \geq z'$ and as above denote by y' the function $S(z')$. Taking $\varphi = -(y - y')^-$ in (4.9) we get

$$\begin{aligned} \int_{\Omega_\ell} D|\nabla(y - y')^-|^2 \, dx + \int_{\Omega_\ell} \lambda((y - y')^-)^2 \, dx + \int_{\Gamma_0} \nu((y - y')^-)^2 \, dx_1 \\ = - \int_{\Omega_\ell} [\lambda(z - z') + \{f(z) - f(z')\}] (y - y')^- \, dx \leq 0, \end{aligned}$$

since $-\{f(z) - f(z')\} \leq L_f |z - z'| \leq \lambda(z - z')$ (see (4.3), (4.4)). This shows that $(y - y')^- = 0$ and the monotonicity of the mapping S .

4. Elliptic problem of the field-road model

We consider now the following sequences (Cf. [6]) :

$$\begin{aligned} \underline{y}_0 &= 0, \quad \overline{y}_0 = \frac{\mu}{\nu}m = k, \\ \underline{y}_n &= S(\underline{y}_{n-1}), \quad \overline{y}_n = S(\overline{y}_{n-1}), \quad n \geq 1. \end{aligned} \tag{4.10}$$

One has

$$\underline{y}_0 = 0 \leq \underline{y}_1 \leq \dots \leq \underline{y}_n \leq \overline{y}_n \leq \dots \leq \overline{y}_1 \leq \overline{y}_0 = \frac{\mu}{\nu}m = k. \tag{4.11}$$

Indeed since $\underline{y}_1 = S(\underline{y}_0) = S(0)$ one has for $\forall \varphi \in V, \varphi \geq 0$,

$$\begin{aligned} & \int_{\Omega_\ell} D\nabla \underline{y}_1 \cdot \nabla \varphi \, dx + \int_{\Omega_\ell} \lambda \underline{y}_1 \varphi \, dx + \int_{\Gamma_0} \nu \underline{y}_1(x_1, 0) \varphi \, dx_1 \\ &= \int_{\Omega_\ell} f(\underline{y}_0) \varphi \, dx + \int_{\Omega_\ell} \lambda \underline{y}_0 \varphi \, dx + \int_{\Gamma_0} \mu w \varphi \, dx_1 \\ &\geq \int_{\Omega_\ell} D\nabla \underline{y}_0 \cdot \nabla \varphi \, dx + \int_{\Omega_\ell} \lambda \underline{y}_0 \varphi \, dx + \int_{\Gamma_0} \nu \underline{y}_0(x_1, 0) \varphi \, dx_1, \end{aligned}$$

since \underline{y}_0 is a subsolution to (4.7). Using this inequality with $\varphi = (\underline{y}_1 - \underline{y}_0)^-$ one derives easily

$$\begin{aligned} & \int_{\Omega_\ell} D\nabla(\underline{y}_1 - \underline{y}_0) \cdot \nabla(\underline{y}_1 - \underline{y}_0)^- \, dx + \int_{\Omega_\ell} \lambda(\underline{y}_1 - \underline{y}_0)(\underline{y}_1 - \underline{y}_0)^- \, dx \\ & \quad + \int_{\Gamma_0} \nu(\underline{y}_1 - \underline{y}_0)(\underline{y}_1 - \underline{y}_0)^- \, dx_1 \geq 0. \end{aligned}$$

Thus it follows that $\underline{y}_1 \geq \underline{y}_0$. With a similar proof one gets that $\overline{y}_1 \leq \overline{y}_0$. Applying S^{n-1} to these inequalities leads to

$$S^{n-1}(\underline{y}_0) = \underline{y}_{n-1} \leq \underline{y}_n = S^{n-1}(\underline{y}_1), \quad S^{n-1}(\overline{y}_0) = \overline{y}_{n-1} \geq \overline{y}_n = S^{n-1}(\overline{y}_1).$$

Furthermore from $\underline{y}_0 \leq \overline{y}_0$ one derives by applying S^n to both sides of the inequality

$$\underline{y}_n \leq \overline{y}_n.$$

This completes the proof of (4.11). Then for some functions $\underline{v}, \overline{v}$ in $L^2(\Omega_\ell)$ one has

$$\underline{y}_n \rightarrow \underline{v}, \quad \overline{y}_n \rightarrow \overline{v} \quad \text{in } L^2(\Omega_\ell).$$

Clearly \underline{v} and \overline{v} are fixed point for S and thus (see (4.8)) solutions to (4.7). This completes the proof of the lemma. \square

We denote by $\lambda_1 = \lambda_1(\Omega_\ell)$ the first eigenvalue of the Dirichlet problem in Ω_ℓ and by φ_1 the corresponding first eigenfunction positive and normalised. More precisely (λ_1, φ_1) is such

that

$$\begin{cases} -\Delta\varphi_1 = \lambda_1\varphi_1 & \text{in } \Omega_\ell, \\ \varphi_1 = 0 & \text{on } \partial\Omega_\ell, \\ \varphi_1(0, \frac{L}{2}) = 1. \end{cases} \quad (4.12)$$

We suppose that for $s > 0$ small enough one has

$$\lambda_1 \leq \frac{f(s)}{Ds}. \quad (4.13)$$

Let us mention that both the normalization for the principal eigenfunction φ_1 and the condition for the principal eigenvalue λ_1 are essential and will play crucial roles in the sequel to derive the main results in the present paper. Indeed, the normalization $\varphi_1(0, \frac{L}{2}) = 1$ can ensure that the subsolution will be bounded away from 0 when passing to the limit $\ell \rightarrow 0$. Therefore, as will be seen in (4.25), the component v_ℓ of the nontrivial solution (u_ℓ, v_ℓ) is bounded from below by a positive constant in a subdomain of Ω_ℓ uniformly in ℓ , which further implies the nontrivial property of the solution in the unbounded strip as the limit of (u_ℓ, v_ℓ) as $\ell \rightarrow +\infty$. We do not know if the condition (4.13) could be relaxed.

Then one has :

Lemma 4.2. *Under the assumptions of the preceding lemma and (4.13), for $\varepsilon > 0$ small enough, the maximal solution \bar{v} to (4.7) satisfies*

$$\varepsilon\varphi_1 \leq \bar{v}.$$

In particular \bar{v} is bounded away from 0.

Proof. Due to (4.13) one has for $\varepsilon > 0$ small enough

$$D\lambda_1\varepsilon\varphi_1 \leq f(\varepsilon\varphi_1).$$

This allows us to show that $\varepsilon\varphi_1$ is a subsolution to (4.7). Indeed, for $\varphi \in V$, $\varphi \geq 0$ it holds after integration by parts

$$\begin{aligned} & \int_{\Omega_\ell} D\nabla(\varepsilon\varphi_1) \cdot \nabla\varphi \, dx + \int_{\Gamma_0} \nu\varepsilon\varphi_1(x_1, 0)\varphi \, dx_1 \\ &= \int_{\Omega_\ell} D\nabla(\varepsilon\varphi_1) \cdot \nabla\varphi \, dx = \int_{\Omega_\ell} \nabla \cdot (D\nabla(\varepsilon\varphi_1)\varphi) - D\Delta(\varepsilon\varphi_1)\varphi \, dx \\ &= \int_{\partial\Omega_\ell} D\partial_n(\varepsilon\varphi_1)\varphi \, d\sigma + \int_{\Omega_\ell} D\lambda_1(\varepsilon\varphi_1)\varphi \, dx \\ &\leq \int_{\Omega_\ell} f(\varepsilon\varphi_1)\varphi \, dx + \int_{\Gamma_0} \mu w\varphi \, dx_1. \end{aligned}$$

4. Elliptic problem of the field-road model

(n denotes the outward unit normal to Ω_ℓ , note that $\partial_n(\varepsilon\varphi_1) \leq 0$). Thus $\varepsilon\varphi_1$ is a positive subsolution to (4.7).

Then one argues as in the preceding lemma introducing the sequence defined for ε small by :

$$\begin{aligned} \underline{y}_0 &= \varepsilon\varphi_1 \leq \frac{\mu}{\nu}m, \quad \overline{y}_0 = \frac{\mu}{\nu}m, \\ \underline{y}_n &= S(\underline{y}_{n-1}), \quad \overline{y}_n = S(\overline{y}_{n-1}), \quad n \geq 1. \end{aligned}$$

One has with the same proof as above

$$\underline{y}_0 = \varepsilon\varphi_1 \leq \underline{y}_1 \leq \cdots \leq \underline{y}_n \leq \overline{y}_n \leq \cdots \leq \overline{y}_1 \leq \overline{y}_0 = \frac{\mu}{\nu}m.$$

The result follows from the fact that $\overline{y}_n \rightarrow \bar{v}$. This completes the proof of the lemma. \square

One has also :

Lemma 4.3. *Suppose that*

$$\frac{f(s)}{s} \text{ is decreasing on } (0, +\infty). \quad (4.14)$$

If v_1, v_2 are positive solutions to (4.7) corresponding to w_1, w_2 respectively then

$$w_1 \leq w_2 \text{ implies } v_1 \leq v_2.$$

In particular (4.7) has a unique positive solution.

Proof. Denote by θ a smooth function such that

$$\theta(t) = 0 \quad \forall t \leq 0, \quad \theta(t) = 1 \quad \forall t \geq 1, \quad \theta'(t) \geq 0.$$

Set $\theta_\varepsilon(t) = \theta(\frac{t}{\varepsilon})$. Clearly

$$v_1\theta_\varepsilon(v_1 - v_2), \quad v_2\theta_\varepsilon(v_1 - v_2) \in V.$$

From the equations satisfied by v_1, v_2 one gets, setting $\theta_\varepsilon = \theta_\varepsilon(v_1 - v_2)$,

$$\begin{aligned} \int_{\Omega_\ell} D\nabla v_1 \cdot \nabla(v_2\theta_\varepsilon) \, dx + \int_{\Gamma_0} \nu v_1(x_1, 0)(v_2\theta_\varepsilon) \, dx_1 \\ = \int_{\Omega_\ell} f(v_1)(v_2\theta_\varepsilon) \, dx + \int_{\Gamma_0} \mu w_1(v_2\theta_\varepsilon) \, dx_1, \end{aligned}$$

$$\begin{aligned} \int_{\Omega_\ell} D\nabla v_2 \cdot \nabla(v_1\theta_\varepsilon) dx + \int_{\Gamma_0} \nu v_2(x_1, 0)(v_1\theta_\varepsilon) dx_1 \\ = \int_{\Omega_\ell} f(v_2)(v_1\theta_\varepsilon) dx + \int_{\Gamma_0} \mu w_2(v_1\theta_\varepsilon) dx_1. \end{aligned}$$

By subtraction we obtain

$$\begin{aligned} \int_{\Omega_\ell} D\{\nabla v_2 \cdot \nabla(v_1\theta_\varepsilon) - \nabla v_1 \cdot \nabla(v_2\theta_\varepsilon)\} dx \\ = \int_{\Omega_\ell} f(v_2)(v_1\theta_\varepsilon) - f(v_1)(v_2\theta_\varepsilon) dx + \int_{\Gamma_0} \mu(w_2v_1 - w_1v_2)\theta_\varepsilon(v_1 - v_2) dx_1. \end{aligned}$$

Clearly the last integral above is nonnegative so that one has

$$\int_{\Omega_\ell} D\{\nabla v_2 \cdot \nabla(v_1\theta_\varepsilon) - \nabla v_1 \cdot \nabla(v_2\theta_\varepsilon)\} dx \geq \int_{\Omega_\ell} f(v_2)(v_1\theta_\varepsilon) - f(v_1)(v_2\theta_\varepsilon) dx.$$

By a simple computation writing θ'_ε for $\theta'_\varepsilon(v_1 - v_2)$ one derives

$$\begin{aligned} & \int_{\Omega_\ell} f(v_2)(v_1\theta_\varepsilon) - f(v_1)(v_2\theta_\varepsilon) dx \\ & \leq \int_{\Omega_\ell} D\{\nabla v_2 \cdot \nabla(v_1\theta_\varepsilon) - \nabla v_1 \cdot \nabla(v_2\theta_\varepsilon)\} dx \\ & = \int_{\Omega_\ell} D\{\nabla v_2 \cdot \nabla(v_1 - v_2)\theta'_\varepsilon v_1 - \nabla v_1 \cdot \nabla(v_1 - v_2)\theta'_\varepsilon v_2\} dx \\ & = \int_{\Omega_\ell} D\{v_1\nabla v_2 - v_2\nabla v_1\} \cdot \nabla(v_1 - v_2)\theta'_\varepsilon dx \\ & = \int_{\Omega_\ell} D\{v_1\nabla v_2 - v_2\nabla v_2 + v_2\nabla v_2 - v_2\nabla v_1\} \cdot \nabla(v_1 - v_2)\theta'_\varepsilon dx \\ & = \int_{\Omega_\ell} D\nabla v_2 \cdot \nabla(v_1 - v_2)(v_1 - v_2)\theta'_\varepsilon dx - \int_{\Omega_\ell} Dv_2|\nabla(v_1 - v_2)|^2\theta'_\varepsilon dx \\ & \leq \int_{\Omega_\ell} D\nabla v_2 \cdot \nabla(v_1 - v_2)(v_1 - v_2)\theta'_\varepsilon dx. \end{aligned}$$

Let us set $\gamma_\varepsilon(t) = \int_0^t s\theta'_\varepsilon(s)ds$ in such a way that the inequality above reads

$$\int_{\Omega_\ell} f(v_2)(v_1\theta_\varepsilon) - f(v_1)(v_2\theta_\varepsilon) dx \leq \int_{\Omega_\ell} D\nabla v_2 \cdot \nabla\gamma_\varepsilon(v_1 - v_2) dx.$$

4. Elliptic problem of the field-road model

From the equation satisfied by v_2 , since $\gamma_\varepsilon(v_1 - v_2) \in V$ and v_2, γ_ε are nonnegative one has

$$\int_{\Omega_\ell} D\nabla v_2 \cdot \nabla \gamma_\varepsilon(v_1 - v_2) dx \leq \int_{\Omega_\ell} f(v_2)\gamma_\varepsilon(v_1 - v_2) dx + \int_{\Gamma_0} \mu w_2 \gamma_\varepsilon(v_1 - v_2) dx_1.$$

Since for some constant C

$$\gamma_\varepsilon(t) \leq \int_0^\varepsilon s \theta'\left(\frac{s}{\varepsilon}\right) \frac{1}{\varepsilon} ds \leq C\varepsilon$$

the right hand side of the above inequality goes to 0 when $\varepsilon \rightarrow 0$. Since when $\varepsilon \rightarrow 0$ one has $\theta_\varepsilon(v_1 - v_2) \rightarrow \chi_{\{v_1 > v_2\}}$ the characteristic function of the set $\{v_1 > v_2\} = \{x \in \Omega_\ell \mid v_1(x) > v_2(x)\}$ one gets

$$\int_{\{v_1 > v_2\}} f(v_2)v_1 - f(v_1)v_2 dx \leq 0.$$

But on the set of integration thanks to (4.14) one has $f(v_2)v_1 - f(v_1)v_2 > 0$ hence the set of integration is necessarily of measure 0, i.e. $v_1 \leq v_2$. This completes the proof of the lemma. \square

4.3 The main result

Theorem 4.4. *Suppose that (4.2)-(4.6),(4.13),(4.14) hold, then the problem (4.1) admits a nontrivial solution.*

Proof. As mentioned above it is of course clear that $(0, 0)$ is solution to (4.1). Set

$$K = \{v \in L^2(\Gamma_0) \mid 0 \leq v \leq m\}.$$

For $u \in K$, let \bar{v} be the unique positive solution to (4.7) associated with $w = u$. For $\eta \geq L_g$ let $U = T(u)$ the solution to

$$\begin{cases} U \in H_0^1(\Gamma_0), \\ \int_{\Gamma_0} D'U' \psi' + \mu U \psi + \eta U \psi dx_1 \\ = \int_{\Gamma_0} \nu \bar{v}(x_1, 0) \psi + g(u) \psi + \eta u \psi dx_1, \forall \psi \in H_0^1(\Gamma_0). \end{cases} \quad (4.15)$$

The existence of U is a consequence of the Lax-Milgram theorem.

We claim that T is continuous on $K \subset L^2(\Gamma_0)$. Indeed suppose that $u_n \rightarrow u$ in K . Denote by \bar{v}_n the solution to (4.7) associated with u_n i.e. satisfying

$$\begin{aligned} & \int_{\Omega_\ell} D\nabla \bar{v}_n \cdot \nabla \varphi dx + \int_{\Gamma_0} \nu \bar{v}_n(x_1, 0) \varphi dx_1 \\ & = \int_{\Omega_\ell} f(\bar{v}_n) \varphi dx + \int_{\Gamma_0} \mu u_n \varphi dx_1 \quad \forall \varphi \in V. \end{aligned} \quad (4.16)$$

Since \bar{v}_n and u_n are bounded, taking $\varphi = \bar{v}_n$ in the equality above one gets easily

$$\int_{\Omega_\ell} D|\nabla\bar{v}_n|^2 dx + \int_{\Gamma_0} \nu\bar{v}_n(x_1, 0)^2 dx_1 \leq C,$$

where C is a constant independent of n . Thus, up to a subsequence, there exists $v \in V$ such that

$$\bar{v}_n \rightharpoonup v \text{ in } H^1(\Omega_\ell), \bar{v}_n \rightarrow v \text{ in } L^2(\Omega_\ell), \bar{v}_n(\cdot, 0) \rightarrow v(\cdot, 0) \text{ in } L^2(\Gamma_0).$$

Passing to the limit in (4.16) it follows from Lemma 4.3 that $v = \bar{v}$ the solution to (4.7) corresponding to $w = u$. By uniqueness of the limit one has convergence of the whole sequence and in particular

$$\bar{v}_n(\cdot, 0) \rightarrow \bar{v}(\cdot, 0) \text{ in } L^2(\Gamma_0).$$

Passing to the limit in (4.15) written for $u = u_n$ one derives $T(u_n) \rightarrow T(u)$ in $L^2(\Gamma_0)$.

We can show also that T is monotone. Indeed, suppose that $u_1 \geq u_2$ and set $U_i = T(u_i)$, $i = 1, 2$. One has, for $\forall \psi \in H_0^1(\Gamma_0)$,

$$\begin{aligned} \int_{\Gamma_0} D'U_1'\psi' + \mu U_1\psi + \eta U_1\psi dx_1 &= \int_{\Gamma_0} \nu\bar{v}_1(x_1, 0)\psi + g(u_1)\psi + \eta u_1\psi dx_1, \\ \int_{\Gamma_0} D'U_2'\psi' + \mu U_2\psi + \eta U_2\psi dx_1 &= \int_{\Gamma_0} \nu\bar{v}_2(x_1, 0)\psi + g(u_2)\psi + \eta u_2\psi dx_1. \end{aligned}$$

By subtraction it comes, for $\forall \psi \in H_0^1(\Gamma_0)$,

$$\begin{aligned} &\int_{\Gamma_0} D'(U_1 - U_2)'\psi' + \mu(U_1 - U_2)\psi + \eta(U_1 - U_2)\psi dx_1 \\ &= \int_{\Gamma_0} \nu(\bar{v}_1(x_1, 0) - \bar{v}_2(x_1, 0))\psi + (g(u_1) - g(u_2))\psi + \eta(u_1 - u_2)\psi dx_1. \end{aligned}$$

Choosing $\psi = -(U_1 - U_2)^-$ and taking into account that, by Lemma 4.3, $\bar{v}_1(x_1, 0) - \bar{v}_2(x_1, 0) \geq 0$ and that for $\eta \geq L_g$, $(g(u_1) - g(u_2)) + \eta(u_1 - u_2) \geq 0$ (Cf. (4.3), (4.4)), one gets

$$\int_{\Gamma_0} D'|\{(U_1 - U_2)^-\}'|^2 + \mu\{(U_1 - U_2)^-\}^2 + \eta\{(U_1 - U_2)^-\}^2 dx_1 \leq 0.$$

Thus $(U_1 - U_2)^- = 0$ and $T(u_1) \geq T(u_2)$.

Next we assert that T maps K into itself. Indeed, if $U_0 = T(0)$ one has, with an obvious notation for \bar{v}_0

$$\int_{\Gamma_0} D'U_0'\psi' + \mu U_0\psi + \eta U_0\psi dx_1 = \int_{\Gamma_0} \nu\bar{v}_0(x_1, 0)\psi dx_1 \quad \forall \psi \in H_0^1(\Gamma_0).$$

4. Elliptic problem of the field-road model

Taking $\psi = -U_0^-$ one deduces easily since $\bar{v}_0 > 0$ that $U_0 = T(0) \geq 0$. Similarly if $U_m = T(m)$ one has, with an obvious notation for \bar{v}_m

$$\int_{\Gamma_0} D'U'_m \psi' + \mu U_m \psi + \eta U_m \psi \, dx_1 = \int_{\Gamma_0} \nu \bar{v}_m(x_1, 0) \psi + g(m) \psi + \eta m \psi \, dx_1 \quad \forall \psi \in H_0^1(\Gamma_0).$$

Thus choosing $\psi = (U_m - m)^+$ it comes since $g(m) \leq 0$, $\bar{v}_m \leq \frac{\mu}{\nu} m$

$$\begin{aligned} \int_{\Gamma_0} D' \{ |(U_m - m)^+ \}'|^2 + (\mu + \eta) \{ (U_m - m)^+ \}^2 \, dx_1 \\ = \int_{\Gamma_0} (\nu \bar{v}_m - \mu m) (U_m - m)^+ \, dx_1 \leq 0. \end{aligned}$$

From this it follows that $U_m \leq m$. By the monotonicity of T it results that T maps the convex K into itself. But clearly $T(K) \subset C^{\frac{1}{2}}(\Gamma_0)$ is relatively compact in $L^2(\Gamma_0)$. Thus, by the Schauder fixed point theorem (see [50], [73], [83]), T has a fixed point in K which leads to a nontrivial solution to (4.1). This completes the proof of the theorem. \square

If it is clear at this point that the solution we constructed is non degenerate in v it is not clear that the same holds for u . In fact we have :

Proposition 4.5. *Let (u, v) be the solution constructed in Theorem 4.4. One has*

$$u \not\equiv 0.$$

Proof. Suppose that $u \equiv 0$. Due to the second equation of (4.1) one has $v(x_1, 0) = 0$ and from the first equation of (4.1) we get

$$\int_{\Omega_\ell} D \nabla v \cdot \nabla \varphi \, dx = \int_{\Omega_\ell} f(v) \varphi \, dx \quad \forall \varphi \in V. \quad (4.17)$$

Consider then a small ball $B = B_{x_0}$ centered at $x_0 \in \Gamma_0$. Set

$$\tilde{v} = \begin{cases} v & \text{in } \Omega_\ell \cap B, \\ 0 & \text{in the rest of the ball.} \end{cases}$$

Let $\varphi \in \mathcal{D}(B)$. One has by (4.17),

$$\int_B D \nabla \tilde{v} \cdot \nabla \varphi \, dx = \int_{\Omega_\ell \cap B} D \nabla v \cdot \nabla \varphi \, dx = \int_{\Omega_\ell \cap B} f(v) \varphi \, dx = \int_B f(\tilde{v}) \varphi \, dx, \quad \forall \varphi \in \mathcal{D}(B).$$

Thus

$$-D \Delta \tilde{v} = f(\tilde{v}) \text{ in } B.$$

It is clear that \tilde{v} and thus $f(\tilde{v})$ are bounded and one has $f(\tilde{v}) \in L^\infty(B) \subset L^p(B) \forall p$. From the usual regularity theory it follows that $\tilde{v} \in W^{2,p}(B) \subset C^{1,\alpha}(B)$. Since $f(\tilde{v}) \geq 0, f(\tilde{v}) \not\equiv 0$ it follows that $\tilde{v} > 0$ in B (see [83]). Hence a contradiction. This shows the impossibility for u to be identical to 0 and this completes the proof of the proposition. \square

Remark 4.6. *One can easily show (see [51], [56]) that*

$$\lambda_1 = \lambda_1(\Omega_\ell) = \left(\frac{\pi}{2\ell}\right)^2 + \left(\frac{\pi}{L}\right)^2.$$

Thus for a smooth function f it is clear that (4.13) is satisfied if

$$\lambda_1 = \lambda_1(\Omega_\ell) < \frac{f'(0)}{D},$$

i.e. for ℓ and L large enough.

Note that (4.14) (see also (4.5)) is satisfied in the case of the Fisher equation i.e. for

$$f(v) = v(1 - v)$$

the Lipschitz character of f being used only on a finite interval.

4.4 Some extension

In this section, we would like to extend our results in the case of a so called two-road elliptic problem, for which the corresponding evolution problem was studied in [140] in high dimensional unbounded cylinders. To be more precise, we set

$$\Gamma'_0 = (-\ell, \ell) \times \{L\}, \quad \Gamma_1 = \partial\Omega_\ell \setminus \{\Gamma_0 \cup \Gamma'_0\},$$

$$V = \{v \in H^1(\Omega_\ell) \mid v = 0 \text{ on } \Gamma_1\},$$

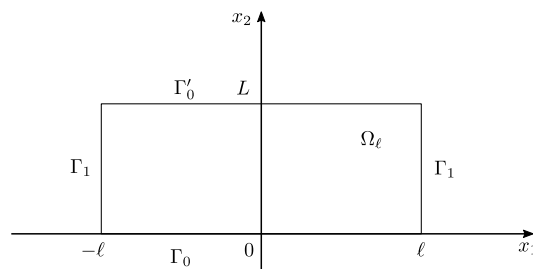

Figure 10: The domain Ω_ℓ for two-road problem

4. Elliptic problem of the field-road model

We consider the problem of finding a (u, v, w) solution to

$$\left\{ \begin{array}{l} (u, v, w) \in H_0^1(\Gamma_0) \times V \times H_0^1(\Gamma'_0), \\ \int_{\Omega_\ell} D \nabla v \cdot \nabla \varphi \, dx + \int_{\Gamma_0} \nu v(x_1, 0) \varphi \, dx_1 + \int_{\Gamma'_0} \nu v(x_1, L) \varphi \, dx_1 \\ = \int_{\Omega_\ell} f(v) \varphi \, dx + \int_{\Gamma_0} \mu u \varphi \, dx_1 + \int_{\Gamma'_0} \mu' w \varphi \, dx_1 \quad \forall \varphi \in V, \\ \int_{\Gamma_0} D' u' \psi' + \mu u \psi \, dx_1 \\ = \int_{\Gamma_0} \nu v(x_1, 0) \psi \, dx_1 + \int_{\Gamma_0} g(u) \psi \, dx_1 \quad \forall \psi \in H_0^1(\Gamma_0), \\ \int_{\Gamma'_0} D'' w' \phi' + \mu' w \phi \, dx_1 \\ = \int_{\Gamma'_0} \nu' v(x_1, L) \phi \, dx_1 + \int_{\Gamma'_0} h(w) \phi \, dx_1 \quad \forall \phi \in H_0^1(\Gamma'_0). \end{array} \right. \quad (4.18)$$

Here we assume that

$$D, D', D'', \mu, \nu, \mu', \nu' \text{ are positive constants,}$$

f, g, h are Lipschitz continuous functions with Lipschitz constants L_f, L_g, L_h respectively (Cf. (4.3)), which implies that for $\lambda \geq L_f, \eta \geq L_g$ and $\xi \geq L_h$ the functions

$$x \rightarrow \lambda x - f(x), \quad \eta x - g(x), \quad \xi x - h(x)$$

are nondecreasing. We will suppose that f satisfies (4.5) and that

$$g(0) = 0, \quad h(0) = 0.$$

Since Γ_0 and Γ'_0 are playing exactly identical roles there is no loss of generality in assuming for instance

$$\frac{\mu}{\nu} \geq \frac{\mu'}{\nu'}.$$

Then for

$$m \geq \frac{\nu}{\mu}, \quad m' = \frac{\nu'}{\mu'} \frac{\mu}{\nu} m,$$

we will assume

$$g(m) \leq 0, \quad h(m') \leq 0. \quad (4.19)$$

One should notice the following properties

$$\frac{\mu}{\nu} m \geq 1, \quad \frac{\mu'}{\nu'} m' = \frac{\mu}{\nu} m.$$

$$m' = \frac{\nu'}{\mu'} \frac{\mu}{\nu} m \geq \frac{\nu'}{\mu'}.$$

Then with small variants we can reproduce the results we had in the preceding sections. First

we have

Lemma 4.7. *Suppose that \tilde{u}, \tilde{w} are measurable functions on Γ_0 and Γ'_0 respectively such that*

$$0 \leq \tilde{u} \leq m, \quad 0 \leq \tilde{w} \leq m'.$$

Then under the assumptions above the problem

$$\begin{cases} v \in V, \\ \int_{\Omega_\ell} D\nabla v \cdot \nabla \varphi \, dx + \int_{\Gamma_0} \nu v(x_1, 0) \varphi(x_1, 0) \, dx_1 \\ + \int_{\Gamma'_0} \nu' v(x_1, L) \varphi(x_1, L) \, dx_1 = \int_{\Omega_\ell} f(v) \varphi \, dx \\ + \int_{\Gamma_0} \mu \tilde{u} \varphi(x_1, 0) \, dx_1 + \int_{\Gamma'_0} \mu' \tilde{w} \varphi(x_1, L) \, dx_1 \quad \forall \varphi \in V, \end{cases} \quad (4.20)$$

possesses a minimal and a maximal solution with values in $[0, \frac{\mu}{\nu}m]$.

Proof. Let us remark first that any nonnegative solution to (4.20) takes its values in $[0, \frac{\mu}{\nu}m]$. Indeed if v is solution to (4.20) taking as test function $\varphi = (v - k)^+$, $k = \frac{\mu}{\nu}m \geq 1$ one gets

$$\begin{aligned} & \int_{\Omega_\ell} D|\nabla(v - k)^+|^2 \, dx \\ &= \int_{\Omega_\ell} D\nabla(v - k) \cdot \nabla(v - k)^+ \, dx = \int_{\Omega_\ell} D\nabla v \cdot \nabla(v - k)^+ \, dx \\ &= \int_{\Omega_\ell} f(v)(v - k)^+ \, dx + \int_{\Gamma_0} \{\mu \tilde{u} - \nu v(x_1, 0)\}(v - k)^+ \, dx_1 \\ & \quad + \int_{\Gamma'_0} \{\mu' \tilde{w} - \nu' v(x_1, L)\}(v - k)^+ \, dx_1 \\ &\leq \int_{\Gamma_0} \{\mu \tilde{u} - \nu v(x_1, 0)\}(v - k)^+ \, dx_1 + \int_{\Gamma'_0} \{\mu' \tilde{w} - \nu' v(x_1, L)\}(v - k)^+ \, dx_1 \\ &\leq 0, \end{aligned}$$

since on the set where $v \geq k = \frac{\mu}{\nu}m = \frac{\mu'}{\nu'}m'$ one has $\{\mu \tilde{u} - \nu v(x_1, 0)\} \leq \{\mu \tilde{u} - \mu m\} \leq 0$ and $\{\mu' \tilde{w} - \nu' v(x_1, L)\} \leq \{\mu' \tilde{w} - \mu' m'\} \leq 0$.

Next let us note that 0 is a subsolution to (4.20). Indeed $\forall \varphi \in V, \varphi \geq 0$, one has

$$\begin{aligned} & \int_{\Omega_\ell} D\nabla 0 \cdot \nabla \varphi \, dx + \int_{\Gamma_0} \nu 0 \varphi \, dx_1 + \int_{\Gamma'_0} \nu' 0 \varphi \, dx_1 \\ & \leq \int_{\Omega_\ell} f(0) \varphi \, dx + \int_{\Gamma_0} \mu \tilde{u} \varphi \, dx_1 + \int_{\Gamma'_0} \mu' \tilde{w} \varphi \, dx_1. \end{aligned}$$

4. Elliptic problem of the field-road model

On the other hand, $k = \frac{\mu}{\nu}m$ is a supersolution since for $\varphi \in V$, $\varphi \geq 0$,

$$\begin{aligned} & \int_{\Omega_\ell} D\nabla k \cdot \nabla \varphi \, dx + \int_{\Gamma_0} \nu k \varphi \, dx_1 + \int_{\Gamma'_0} \nu' k \varphi \, dx_1 \\ & \geq \int_{\Omega_\ell} f(k) \varphi \, dx + \int_{\Gamma_0} \mu \tilde{u} \varphi \, dx_1 + \int_{\Gamma'_0} \mu' \tilde{w} \varphi \, dx_1. \end{aligned}$$

For $z \in L^2(\Omega_\ell)$ we denote by $y = S(z)$ the solution to

$$\begin{cases} y \in V, \\ \int_{\Omega_\ell} D\nabla y \cdot \nabla \varphi \, dx + \int_{\Omega_\ell} \lambda y \varphi \, dx + \int_{\Gamma_0} \nu y(x_1, 0) \varphi \, dx_1 + \int_{\Gamma'_0} \nu' y(x_1, L) \varphi \, dx_1 \\ \quad = \int_{\Omega_\ell} f(z) \varphi \, dx + \int_{\Omega_\ell} \lambda z \varphi \, dx + \int_{\Gamma_0} \mu \tilde{u} \varphi \, dx_1 + \int_{\Gamma'_0} \mu' \tilde{w} \varphi \, dx_1 \quad \forall \varphi \in V, \end{cases}$$

where $\lambda \geq L_f$. The existence of a unique solution y to the problem above follows from the Lax-Milgram theorem. Then reproducing the arguments of Lemma 4.1 it is easy to show that S is continuous and monotone. Introducing the sequence defined in (4.10) one concludes as in the Lemma 4.1 to the existence of a minimal and a maximal solution \underline{v} and \bar{v} . \square

Then one has :

Lemma 4.8. *Under the assumptions of the preceding lemma and (4.13), for $\varepsilon > 0$ small enough, the maximal solution \bar{v} to (4.20) satisfies*

$$\varepsilon \varphi_1 \leq \bar{v}.$$

In particular \bar{v} is bounded away from 0.

Proof. Due to (4.13) one has for $\varepsilon > 0$ small enough

$$D\lambda_1 \varepsilon \varphi_1 \leq f(\varepsilon \varphi_1).$$

Then for $\varphi \in V$, $\varphi \geq 0$ it holds after integration by parts

$$\begin{aligned} & \int_{\Omega_\ell} D\nabla(\varepsilon \varphi_1) \cdot \nabla \varphi \, dx + \int_{\Gamma_0} \nu \varepsilon \varphi_1(x_1, 0) \varphi \, dx_1 + \int_{\Gamma'_0} \nu' \varepsilon \varphi_1(x_1, L) \varphi \, dx_1 \\ & = \int_{\Omega_\ell} D\nabla(\varepsilon \varphi_1) \cdot \nabla \varphi \, dx = \int_{\Omega_\ell} \nabla \cdot (D\nabla(\varepsilon \varphi_1) \varphi) - D\Delta(\varepsilon \varphi_1) \varphi \, dx \\ & = \int_{\partial\Omega_\ell} D\partial_n(\varepsilon \varphi_1) \varphi \, d\sigma + \int_{\Omega_\ell} D\lambda_1(\varepsilon \varphi_1) \varphi \, dx \\ & \leq \int_{\Omega_\ell} f(\varepsilon \varphi_1) \varphi \, dx + \int_{\Gamma_0} \mu \tilde{u} \varphi \, dx_1 + \int_{\Gamma'_0} \mu' \tilde{w} \varphi \, dx_1. \end{aligned}$$

(n denotes the outward unit normal to Ω_ℓ , note that $\partial_n(\varepsilon\varphi_1) \leq 0$). Thus $\varepsilon\varphi_1$ is a positive subsolution to (4.20) and one concludes as in the proof of Lemma 4.2. \square

By analogy to Lemma 4.3 one has :

Lemma 4.9. *Suppose that f satisfies (4.14). If v_1, v_2 are positive solutions to (4.20) corresponding to (u_1, w_1) and (u_2, w_2) respectively then*

$$u_1 \leq u_2 \text{ and } w_1 \leq w_2 \text{ implies } v_1 \leq v_2.$$

In particular (4.20) has a unique positive solution.

Proof. Denote by θ a smooth function such that

$$\theta(t) = 0 \quad \forall t \leq 0, \quad \theta(t) = 1 \quad \forall t \geq 1, \quad \theta'(t) \geq 0.$$

Set $\theta_\varepsilon(t) = \theta(\frac{t}{\varepsilon})$. Clearly

$$v_1\theta_\varepsilon(v_1 - v_2), \quad v_2\theta_\varepsilon(v_1 - v_2) \in V.$$

From the equations satisfied by v_1, v_2 one gets, setting $\theta_\varepsilon = \theta_\varepsilon(v_1 - v_2)$,

$$\begin{aligned} & \int_{\Omega_\ell} D\nabla v_1 \cdot \nabla(v_2\theta_\varepsilon) \, dx + \int_{\Gamma_0} \nu v_1(x_1, 0)(v_2\theta_\varepsilon) \, dx_1 + \int_{\Gamma'_0} \nu' v_1(x_1, L)(v_2\theta_\varepsilon) \, dx_1 \\ &= \int_{\Omega_\ell} f(v_1)(v_2\theta_\varepsilon) \, dx + \int_{\Gamma_0} \mu u_1(v_2\theta_\varepsilon) \, dx_1 + \int_{\Gamma'_0} \mu' w_1(v_2\theta_\varepsilon) \, dx_1, \end{aligned}$$

$$\begin{aligned} & \int_{\Omega_\ell} D\nabla v_2 \cdot \nabla(v_1\theta_\varepsilon) \, dx + \int_{\Gamma_0} \nu v_2(x_1, 0)(v_1\theta_\varepsilon) \, dx_1 + \int_{\Gamma'_0} \nu' v_2(x_1, L)(v_1\theta_\varepsilon) \, dx_1 \\ &= \int_{\Omega_\ell} f(v_2)(v_1\theta_\varepsilon) \, dx + \int_{\Gamma_0} \mu u_2(v_1\theta_\varepsilon) \, dx_1 + \int_{\Gamma'_0} \mu' w_2(v_1\theta_\varepsilon) \, dx_1. \end{aligned}$$

By subtraction we obtain

$$\begin{aligned} & \int_{\Omega_\ell} D\{\nabla v_2 \cdot \nabla(v_1\theta_\varepsilon) - \nabla v_1 \cdot \nabla(v_2\theta_\varepsilon)\} \, dx = \int_{\Omega_\ell} f(v_2)(v_1\theta_\varepsilon) - f(v_1)(v_2\theta_\varepsilon) \, dx \\ & \quad + \int_{\Gamma_0} \mu(u_2v_1 - u_1v_2)\theta_\varepsilon(v_1 - v_2) \, dx_1 + \int_{\Gamma'_0} \mu'(w_2v_1 - w_1v_2)\theta_\varepsilon(v_1 - v_2) \, dx_1. \end{aligned}$$

Clearly the last two integrals above are nonnegative so that one has

$$\int_{\Omega_\ell} D\{\nabla v_2 \cdot \nabla(v_1\theta_\varepsilon) - \nabla v_1 \cdot \nabla(v_2\theta_\varepsilon)\} \, dx \geq \int_{\Omega_\ell} f(v_2)(v_1\theta_\varepsilon) - f(v_1)(v_2\theta_\varepsilon) \, dx.$$

4. Elliptic problem of the field-road model

Then the rest of the proof is like in Lemma 4.3. \square

Then we can show :

Theorem 4.10. *Under the assumptions above the problem (4.18) admits a nontrivial solution.*

Proof. It is of course clear that $(0, 0, 0)$ is solution to (4.18). Set

$$K = \{u \in L^2(\Gamma_0) \mid 0 \leq u \leq m\}, \quad K' = \{w \in L^2(\Gamma'_0) \mid 0 \leq w \leq m'\}.$$

For $(u, w) \in K \times K'$, let \bar{v} be the unique positive solution to (4.20) associated with $(\tilde{u}, \tilde{w}) = (u, w)$. For $\eta \geq L_g$, $\xi \geq L_h$, let $(U, W) = T(u, w)$ be the solution to

$$\begin{cases} (U, W) \in H_0^1(\Gamma_0) \times H_0^1(\Gamma'_0), \\ \int_{\Gamma_0} D'U'\psi' + \mu U\psi + \eta U\psi \, dx_1 = \int_{\Gamma_0} \nu\bar{v}(x_1, 0)\psi + g(u)\psi + \eta u\psi \, dx_1 \quad \forall \psi \in H_0^1(\Gamma_0), \\ \int_{\Gamma'_0} D''W'\phi' + \mu'W\phi + \xi W\phi \, dx_1 \\ = \int_{\Gamma'_0} \nu'\bar{v}(x_1, L)\phi + h(w)\phi + \xi w\phi \, dx_1 \quad \forall \phi \in H_0^1(\Gamma'_0). \end{cases}$$

The existence of (U, W) is a consequence of the Lax-Milgram theorem.

We show as in Theorem 4.4 that T is continuous on $K \times K' \subset L^2(\Gamma_0) \times L^2(\Gamma'_0)$. Indeed suppose that $u_n \rightarrow u$ in K and $w_n \rightarrow w$ in K' . Denote by \bar{v}_n the solution to (4.20) associated with (u_n, w_n) i.e. satisfying

$$\begin{aligned} \int_{\Omega_\ell} D\nabla\bar{v}_n \cdot \nabla\varphi \, dx + \int_{\Gamma_0} \nu\bar{v}_n(x_1, 0)\varphi \, dx_1 + \int_{\Gamma'_0} \nu'\bar{v}_n(x_1, L)\varphi \, dx_1 \\ = \int_{\Omega_\ell} f(\bar{v}_n)\varphi \, dx + \int_{\Gamma_0} \mu u_n\varphi \, dx_1 + \int_{\Gamma'_0} \mu' w_n\varphi \, dx_1 \quad \forall \varphi \in V. \end{aligned} \tag{4.21}$$

Since \bar{v}_n , u_n and w_n are bounded, taking $\varphi = \bar{v}_n$ in the equality above one gets easily

$$\int_{\Omega_\ell} D|\nabla\bar{v}_n|^2 \, dx + \int_{\Gamma_0} \nu\bar{v}_n(x_1, 0)^2 \, dx_1 + \int_{\Gamma'_0} \nu'\bar{v}_n(x_1, L)^2 \, dx_1 \leq C,$$

where C is a constant independent of n . Thus, up to a subsequence, there exists $v \in V$ such that

$$\begin{aligned} \bar{v}_n &\rightharpoonup v \text{ in } H^1(\Omega_\ell), \quad \bar{v}_n \rightarrow v \text{ in } L^2(\Omega_\ell), \\ \bar{v}_n(\cdot, 0) &\rightarrow v(\cdot, 0) \text{ in } L^2(\Gamma_0), \quad \bar{v}_n(\cdot, L) \rightarrow v(\cdot, L) \text{ in } L^2(\Gamma'_0). \end{aligned}$$

Passing to the limit in (4.21) one derives as in Theorem 4.4 that $T(u_n, w_n) \rightarrow T(u, w)$ in $L^2(\Gamma_0) \times L^2(\Gamma'_0)$.

We can show also that T is monotone. Indeed, suppose that $(u_1, w_1) \geq (u_2, w_2)$ in the sense that $u_1 \geq u_2$ and $w_1 \geq w_2$ and set $(U_i, W_i) = T(u_i, w_i)$, $i = 1, 2$. First, for U_i one has

$$\begin{aligned} \int_{\Gamma_0} D'U_1'\psi' + \mu U_1\psi + \eta U_1\psi \, dx_1 &= \int_{\Gamma_0} \nu \bar{v}_1(x_1, 0)\psi + g(u_1)\psi + \eta u_1\psi \, dx_1 \quad \forall \psi \in H_0^1(\Gamma_0), \\ \int_{\Gamma_0} D'U_2'\psi' + \mu U_2\psi + \eta U_2\psi \, dx_1 &= \int_{\Gamma_0} \nu \bar{v}_2(x_1, 0)\psi + g(u_2)\psi + \eta u_2\psi \, dx_1 \quad \forall \psi \in H_0^1(\Gamma_0). \end{aligned}$$

By subtraction it comes

$$\begin{aligned} \int_{\Gamma_0} D'(U_1 - U_2)'\psi' + \mu(U_1 - U_2)\psi + \eta(U_1 - U_2)\psi \, dx_1 \\ = \int_{\Gamma_0} \nu(\bar{v}_1(x_1, 0) - \bar{v}_2(x_1, 0))\psi + (g(u_1) - g(u_2))\psi + \eta(u_1 - u_2)\psi \, dx_1 \quad \forall \psi \in H_0^1(\Gamma_0). \end{aligned}$$

Choosing $\psi = -(U_1 - U_2)^-$ and taking into account that, by Lemma 4.9, $\bar{v}_1(x_1, 0) - \bar{v}_2(x_1, 0) \geq 0$ and that for $\eta \geq L_g$, $(g(u_1) - g(u_2)) + \eta(u_1 - u_2) \geq 0$ (Cf. (4.3), (4.4)), one gets

$$\int_{\Gamma_0} D'|\{(U_1 - U_2)^-\}'|^2 + \mu\{(U_1 - U_2)^-\}^2 + \eta\{(U_1 - U_2)^-\}^2 \, dx_1 \leq 0.$$

Thus $(U_1 - U_2)^- = 0$ and $U_1 \geq U_2$. Similarly one shows that $W_1 \geq W_2$.

Next we assert that T maps $K \times K'$ into itself. Indeed, if $(U_0, W_0) = T(0, 0)$ one has, with an obvious notation for \bar{v}_0

$$\begin{aligned} \int_{\Gamma_0} D'U_0'\psi' + \mu U_0\psi + \eta U_0\psi \, dx_1 &= \int_{\Gamma_0} \nu \bar{v}_0(x_1, 0)\psi \, dx_1 \quad \forall \psi \in H_0^1(\Gamma_0), \\ \int_{\Gamma'_0} D''W_0'\phi' + \mu W_0\phi + \xi W_0\phi \, dx_1 &= \int_{\Gamma'_0} \nu' \bar{v}_0(x_1, L)\phi \, dx_1 \quad \forall \phi \in H_0^1(\Gamma'_0). \end{aligned}$$

Taking $\psi = -U_0^-$, $\phi = -W_0^-$, one deduces easily since $\bar{v}_0(x_1, 0) \geq 0$ and $\bar{v}_0(x_1, L) \geq 0$ that $U_0 \geq 0$ and $W_0 \geq 0$. Similarly, if $(U_1, W_1) = T(m, m')$ one has, with an obvious notation for \bar{v}_1

$$\int_{\Gamma_0} D'U_1'\psi' + \mu U_1\psi + \eta U_1\psi \, dx_1 = \int_{\Gamma_0} \nu \bar{v}_1(x_1, 0)\psi + g(m)\psi + \eta m\psi \, dx_1, \quad \forall \psi \in H_0^1(\Gamma_0),$$

4. Elliptic problem of the field-road model

$$\int_{\Gamma'_0} D'' W'_1 \phi' + \mu' W_1 \phi + \xi W_1 \phi \, dx_1 = \int_{\Gamma'_0} \nu' \bar{v}_1(x_1, L) \phi + h(m') \phi + \xi m' \phi \, dx_1, \forall \phi \in H_0^1(\Gamma'_0).$$

Thus choosing $\psi = (U_1 - m)^+$ and $\phi = (W_1 - m')^+$, due to (4.19) and $\bar{v}_1 \leq \frac{\mu}{\nu} m = \frac{\mu'}{\nu'} m'$ it comes

$$\begin{aligned} & \int_{\Gamma_0} D' |\{(U_1 - m)^+\}'|^2 + (\mu + \eta) \{(U_1 - m)^+\}^2 \, dx_1 \\ & \leq \int_{\Gamma_0} (\nu \bar{v}_1(x_1, 0) - \mu m) (U_1 - m)^+ \, dx_1 \leq 0. \\ & \int_{\Gamma'_0} D'' |\{(W_1 - m')^+\}'|^2 + (\mu' + \xi) \{(W_1 - m')^+\}^2 \, dx_1 \\ & \leq \int_{\Gamma'_0} (\nu' \bar{v}_1(x_1, L) - \mu' m') (W_1 - m')^+ \, dx_1 \leq 0. \end{aligned}$$

From this it follows that $U_1 \leq m$, $W_1 \leq m'$. By the monotonicity of T it results that T maps the convex $K \times K'$ into itself. But clearly $T(K \times K') \subset C^{\frac{1}{2}}(\Gamma_0) \times C^{\frac{1}{2}}(\Gamma'_0)$ is relatively compact in $L^2(\Gamma_0) \times L^2(\Gamma'_0)$. Thus, by the Schauder fixed point theorem (see [50], [73], [83]), T has a fixed point in $K \times K'$ which leads to a nontrivial solution (u, v, w) to (4.18). This completes the proof of the theorem. \square

Remark 4.11. *One can show as in Proposition 4.5 that u, w are also non degenerate in the sense that*

$$u \not\equiv 0, \quad w \not\equiv 0.$$

4.5 The case of an unbounded domain

The goal of this section is to show that when $\ell = +\infty$ it remains possible to define and find a nontrivial solution to problem (4.1), for which we refer to [31] and [152] for relevant study of the evolution problem in half space and in an unbounded strip, respectively. Let us introduce some notation. For convenience we will denote by V_ℓ the space V defined in Section 1. Similarly we will indicate the dependence in ℓ for Γ_0 , i.e.

$$\Gamma_0 = \Gamma_0^\ell = (-\ell, \ell) \times \{0\}.$$

When convenient we will set $I_\ell = (-\ell, \ell)$. In addition, we set

$$\Omega_\infty = \mathbb{R} \times (0, L), \quad \Gamma_0^\infty = \mathbb{R} \times \{0\}, \quad \Gamma_1^\infty = \mathbb{R} \times \{L\},$$

$$V_\infty = \{v \in H_{loc}^1(\overline{\Omega_\infty}) \mid v = 0 \text{ on } \Gamma_1^\infty\},$$

where

$$H_{loc}^1(\overline{\Omega_\infty}) = \{v \mid v \in H^1(\Omega_{\ell_0}) \forall \ell_0 > 0\}.$$

Then we have

Theorem 4.12. *Suppose that (4.2), (4.3), (4.5), (4.6), (4.14) hold and that*

$$\frac{f(s)}{Ds} > \left(\frac{\pi}{L}\right)^2, \quad (4.22)$$

then under the assumptions above there exists (u, v) nontrivial solution to

$$\begin{cases} (u, v) \in H_0^1(\Gamma_0^\infty) \times V_\infty, \\ \int_{\Omega_{\ell_0}} D\nabla v \cdot \nabla \varphi \, dx + \int_{I_{\ell_0}} \nu v(x_1, 0) \varphi \, dx_1 \\ = \int_{\Omega_{\ell_0}} f(v) \varphi \, dx + \int_{I_{\ell_0}} \mu u \varphi \, dx_1 \quad \forall \varphi \in V_{\ell_0}, \quad \forall \ell_0, \\ \int_{I_{\ell_0}} D'u' \psi' + \mu u \psi \, dx_1 \\ = \int_{I_{\ell_0}} \nu v(x_1, 0) \psi \, dx_1 + \int_{I_{\ell_0}} g(u) \psi \, dx_1 \quad \forall \psi \in H_0^1(I_{\ell_0}), \quad \forall \ell_0. \end{cases} \quad (4.23)$$

(We identify Γ_0^∞ with \mathbb{R} . Recall that $I_\ell = (-\ell, \ell)$).

Proof. Let (u_ℓ, v_ℓ) be a solution to (4.1). We can find such a solution for every ℓ sufficiently large such that (4.13), i.e., $\lambda(\Omega_\ell) \leq \frac{f(s)}{Ds}$ holds, thanks to Theorem 4.4 and (4.22). Note that $\lambda(\Omega_\ell) = \left(\frac{\pi}{2\ell}\right)^2 + \left(\frac{\pi}{L}\right)^2$ (see [51]). One notices that for $\ell' \geq \ell$ there holds

$$\Omega_\ell \subset \Omega_{\ell'}, \quad H_0^1(\Omega_\ell) \subset H_0^1(\Omega_{\ell'}),$$

(we suppose the functions of $H_0^1(\Omega_\ell)$ extended by 0 outside Ω_ℓ). By definition of $\lambda_1 = \lambda_1(\Omega_\ell)$ one has

$$\lambda_1(\Omega_\ell) = \inf_{H_0^1(\Omega_\ell) \setminus \{0\}} \frac{\int_{\Omega_\ell} |\nabla v|^2 dx}{\int_{\Omega_\ell} v^2 dx},$$

and thus clearly

$$\lambda_1(\Omega_{\ell'}) \leq \lambda_1(\Omega_\ell) \quad \forall \ell' \geq \ell.$$

Let us assume for some $\ell_1 > 0$ (Cf. (4.13))

$$\lambda_1(\Omega_{\ell_1}) \leq \frac{f(s)}{Ds} \quad \text{for } s > 0 \text{ small enough.} \quad (4.24)$$

Then for any $\ell \geq \ell_1$ one has for $s > 0$ small enough

$$\lambda_1(\Omega_\ell) \leq \frac{f(s)}{Ds}.$$

Moreover, since it is easy to see that φ_1 defined in (4.12) is given by

$$\varphi_1 = \sin \frac{\pi}{2\ell}(x_1 + \ell) \sin \frac{\pi}{L} x_2,$$

4. Elliptic problem of the field-road model

one has $0 \leq \varphi_1 \leq 1$ and if (4.24) holds one has

$$D\lambda_1(\Omega_\ell)\varepsilon\varphi_1 \leq f(\varepsilon\varphi_1)$$

for $\varepsilon > 0$ small enough independently of $\ell \geq \ell_1$. We suppose from now on that this ε is fixed such that if (u_ℓ, v_ℓ) is a solution to (4.1) constructed as in Theorem 4.4 one has

$$\varepsilon\varphi_1 \leq v_\ell$$

and in particular for every $\ell \geq \ell_1$

$$\varepsilon(\sin \frac{\pi}{4})^2 \leq \varepsilon\varphi_1 \leq v_\ell \quad \text{a.e. } x \in (-\frac{\ell}{2}, \frac{\ell}{2}) \times (\frac{L}{4}, \frac{3L}{4}). \quad (4.25)$$

One should also notice that independently of ℓ one has

$$0 \leq u_\ell \leq m, \quad \varepsilon\varphi_1 \leq v_\ell \leq \frac{\mu}{\nu}m. \quad (4.26)$$

We assume from now on $\ell \geq \ell_1$ and for $\ell_0 \leq \ell - 1$ we define ρ by

$$\rho = \rho(x_1) = \begin{cases} 1 & \text{on } I_{\ell_0}, \\ x_1 + \ell_0 + 1 & \text{on } (-\ell_0 - 1, -\ell_0), \\ -x_1 + \ell_0 + 1 & \text{on } (\ell_0, \ell_0 + 1), \\ 0 & \text{outside } I_{\ell_0+1}, \end{cases}$$

whose graph is depicted below.

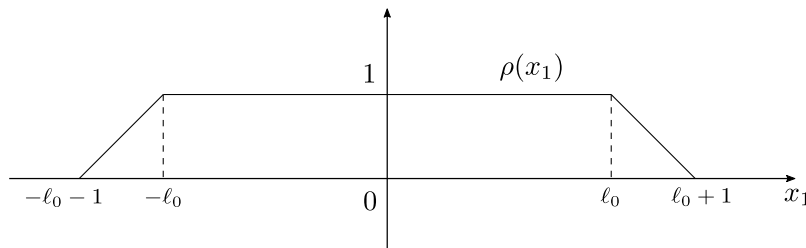

Figure 11: The graph of the function $\rho(x_1)$

Clearly $\rho^2 v_\ell = \rho^2(x_1)v_\ell \in V_\ell$ and from the first equation of (4.1) one gets

$$\begin{aligned} & \int_{\Omega_\ell} D\nabla v_\ell \cdot \nabla(\rho^2 v_\ell) \, dx + \int_{\Gamma_0} \nu \rho^2 v_\ell^2(x_1, 0) \, dx_1 \\ &= \int_{\Omega_\ell} f(v_\ell) \rho^2 v_\ell \, dx + \int_{\Gamma_0} \mu u_\ell \rho^2 v_\ell(x_1, 0) \, dx_1. \end{aligned} \quad (4.27)$$

One should notice that in the integrals over Ω_ℓ one integrates only on Ω_{ℓ_0+1} and for the ones over Γ_0 on I_{ℓ_0+1} . Then remark that

$$\int_{\Omega_\ell} \nabla v_\ell \cdot \nabla(\rho^2 v_\ell) dx = \int_{\Omega_\ell} |\nabla v_\ell|^2 \rho^2 + 2\rho v_\ell \nabla v_\ell \cdot \nabla \rho dx,$$

and

$$\int_{\Omega_\ell} |\nabla(\rho v_\ell)|^2 dx = \int_{\Omega_\ell} |\rho \nabla v_\ell + v_\ell \nabla \rho|^2 dx = \int_{\Omega_\ell} |\nabla v_\ell|^2 \rho^2 + 2\rho v_\ell \nabla v_\ell \cdot \nabla \rho + v_\ell^2 |\nabla \rho|^2 dx.$$

From this it follows that

$$\int_{\Omega_\ell} \nabla v_\ell \cdot \nabla(\rho^2 v_\ell) dx = \int_{\Omega_\ell} |\nabla(\rho v_\ell)|^2 dx - \int_{\Omega_\ell} v_\ell^2 |\nabla \rho|^2 dx.$$

Thus, since the second integral of (4.27) is nonnegative, it comes

$$\begin{aligned} & D \int_{\Omega_{\ell_0+1}} |\nabla(\rho v_\ell)|^2 dx \\ & \leq D \int_{\Omega_{\ell_0+1}} v_\ell^2 |\nabla \rho|^2 dx + \int_{\Omega_{\ell_0+1}} f(v_\ell) \rho^2 v_\ell dx + \int_{I_{\ell_0+1}} \mu u_\ell \rho^2 v_\ell(x_1, 0) dx_1. \end{aligned}$$

Using the definition of ρ and in particular the fact that $\rho = 1$ on Ω_{ℓ_0} we get easily by (4.26)

$$\int_{\Omega_{\ell_0}} |\nabla v_\ell|^2 dx \leq C \tag{4.28}$$

where C is independent of ℓ . Taking now $\psi = \rho^2 u_\ell$ in the second equation of (4.1) we get

$$\int_{I_{\ell_0+1}} D' u'_\ell (\rho^2 u_\ell)' + \mu \rho^2 u_\ell^2 dx_1 = \int_{I_{\ell_0+1}} \nu v_\ell(x_1, 0) \rho^2 u_\ell + g(u_\ell) \rho^2 u_\ell dx_1.$$

Arguing as above we derive easily

$$\int_{I_{\ell_0+1}} u'_\ell (\rho^2 u_\ell)' dx_1 = \int_{I_{\ell_0+1}} |(\rho u_\ell)'|^2 dx_1 - \int_{I_{\ell_0+1}} u_\ell^2 \rho'^2 dx_1.$$

This leads to

$$\int_{I_{\ell_0+1}} D' |(\rho u_\ell)'|^2 + \mu \rho^2 u_\ell^2 dx_1 \leq \int_{I_{\ell_0+1}} D' u_\ell^2 \rho'^2 dx_1 + \nu v_\ell(x_1, 0) \rho^2 u_\ell + g(u_\ell) \rho^2 u_\ell dx_1.$$

4. Elliptic problem of the field-road model

Integrating only on I_{ℓ_0} in the first integral i.e. where $\rho = 1$ we obtain

$$\int_{I_{\ell_0}} (u'_\ell)^2 + u_\ell^2 dx_1 \leq C \quad (4.29)$$

where C is some other constant independent of ℓ . It results from (4.28), (4.29) that (u_ℓ, v_ℓ) is bounded in $H^1(I_{\ell_0}) \times V_{\ell_0}$ independently of ℓ . Thus there exists a subsequence of (u_ℓ, v_ℓ) that we will denote by $(u_{n,0}, v_{n,0})$ such when $n \rightarrow \infty$

$$\begin{aligned} u_{n,0} &\rightharpoonup u^0 \text{ in } H^1(I_{\ell_0}), \quad v_{n,0} \rightharpoonup v^0 \text{ in } V_{\ell_0}, \\ u_{n,0} &\rightarrow u^0 \text{ in } L^2(I_{\ell_0}), \quad v_{n,0} \rightarrow v^0 \text{ in } L^2(\Omega_{\ell_0}), \\ v_{n,0}(\cdot, 0) &\rightarrow v^0(\cdot, 0) \text{ in } L^2(I_{\ell_0}). \end{aligned}$$

Considering the equations

$$\begin{aligned} \int_{\Omega_{\ell_0}} D\nabla v_\ell \cdot \nabla \varphi dx + \int_{I_{\ell_0}} \nu v_\ell(x_1, 0) \varphi dx_1 &= \int_{\Omega_{\ell_0}} f(v_\ell) \varphi dx + \int_{I_{\ell_0}} \mu u_\ell \varphi dx_1 \quad \forall \varphi \in V_{\ell_0}, \\ \int_{I_{\ell_0}} D' u'_\ell \psi' + \mu u_\ell \psi dx_1 &= \int_{I_{\ell_0}} \nu v_\ell(x_1, 0) \psi dx_1 + \int_{I_{\ell_0}} g(u_\ell) \psi dx_1 \quad \forall \psi \in H_0^1(I_{\ell_0}), \end{aligned}$$

with (u_ℓ, v_ℓ) replaced by $(u_{n,0}, v_{n,0})$, one can pass to the limit in n and see that $(u^0, v^0) \in H^1(I_{\ell_0}) \times V_{\ell_0}$ satisfies

$$\begin{aligned} \int_{\Omega_{\ell_0}} D\nabla v^0 \cdot \nabla \varphi dx + \int_{I_{\ell_0}} \nu v^0(x_1, 0) \varphi dx_1 &= \int_{\Omega_{\ell_0}} f(v^0) \varphi dx + \int_{I_{\ell_0}} \mu u^0 \varphi dx_1 \quad \forall \varphi \in V_{\ell_0}, \\ \int_{I_{\ell_0}} D' u^{0'} \psi' + \mu u^0 \psi dx_1 &= \int_{I_{\ell_0}} \nu v^0(x_1, 0) \psi dx_1 + \int_{I_{\ell_0}} g(u^0) \psi dx_1 \quad \forall \psi \in H_0^1(I_{\ell_0}). \end{aligned}$$

(Note that a function of V_{ℓ_0} extended by 0 belongs to V_ℓ). Clearly -as a subsequence of (u_ℓ, v_ℓ) - the sequence $(u_{n,0}, v_{n,0})$ is bounded in $H^1(I_{\ell_0+1}) \times V_{\ell_0+1}$ independently of n and one can extract a subsequence that we still label by n and denote by $(u_{n,1}, v_{n,1})$ such that

$$\begin{aligned} u_{n,1} &\rightharpoonup u^1 \text{ in } H^1(I_{\ell_0+1}), \quad v_{n,1} \rightharpoonup v^1 \text{ in } V_{\ell_0+1}, \\ u_{n,1} &\rightarrow u^1 \text{ in } L^2(I_{\ell_0+1}), \quad v_{n,1} \rightarrow v^1 \text{ in } L^2(\Omega_{\ell_0+1}), \\ v_{n,1}(\cdot, 0) &\rightarrow v^1(\cdot, 0) \text{ in } L^2(I_{\ell_0+1}). \end{aligned}$$

Note that $(u^1, v^1) = (u^0, v^0)$ on $I_{\ell_0} \times \Omega_{\ell_0}$. Clearly (u^1, v^1) satisfies

$$\begin{aligned} & \int_{\Omega_{\ell_0+1}} D\nabla v^1 \cdot \nabla \varphi \, dx + \int_{I_{\ell_0+1}} \nu v^1(x_1, 0) \varphi \, dx_1 \\ &= \int_{\Omega_{\ell_0+1}} f(v^1) \varphi \, dx + \int_{I_{\ell_0+1}} \mu u^1 \varphi \, dx_1 \quad \forall \varphi \in V_{\ell_0+1}, \\ & \int_{I_{\ell_0+1}} D'u^{1'} \psi' + \mu u^1 \psi \, dx_1 \\ &= \int_{I_{\ell_0+1}} \nu v^1(x_1, 0) \psi \, dx_1 + \int_{I_{\ell_0+1}} g(u^1) \psi \, dx_1 \quad \forall \psi \in H_0^1(I_{\ell_0+1}). \end{aligned}$$

By induction one constructs a sequence $(u_{n,k}, v_{n,k})$ extracted from the preceding, converging toward (u^k, v^k) and satisfying the equations above where we have replaced $\ell_0 + 1$ by $\ell_0 + k$. Then using the usual diagonal process it is clear that the sequence $(u_{n,n}, v_{n,n})$ will converge toward a nontrivial solution to (4.23) thanks to (4.25). This completes the proof of the theorem. \square

Chapter 5

Reaction-diffusion fronts in funnel-shaped domains¹

5.1 Introduction and main results

This chapter is devoted to the study of propagation phenomena of time-global (entire) bounded solutions $u = u(t, x)$ of reaction-diffusion equations of the type

$$\begin{cases} u_t = \Delta u + f(u), & t \in \mathbb{R}, x \in \bar{\Omega}, \\ \nu \cdot \nabla u = 0, & t \in \mathbb{R}, x \in \partial\Omega, \end{cases} \quad (5.1)$$

in certain unbounded smooth domains $\Omega \subset \mathbb{R}^N$ with $N \geq 2$. Here u_t stands for $\frac{\partial u}{\partial t}$, and $\nu = \nu(x)$ is the outward unit normal on the boundary $\partial\Omega$, that is, Neumann boundary conditions are imposed on $\partial\Omega$. Equations of type (5.1) arise especially in the fields of population dynamics, mathematical ecology, physics and also medicine and biology. The function u typically stands for the temperature or the concentration of a species. It is assumed to be bounded, then with no loss of generality we suppose that it takes values in $[0, 1]$. The reaction term f is assumed to be of class $C^{1,1}([0, 1], \mathbb{R})$ and such that

$$f(0) = f(1) = 0, \quad f'(0) < 0, \quad f'(1) < 0, \quad (5.2)$$

which means that both 0 and 1 are stable zeros of f . Moreover, we assume that f is of the bistable type with positive mass, that is, there exists $\theta \in (0, 1)$ such that

$$f < 0 \text{ in } (0, \theta), \quad f > 0 \text{ in } (\theta, 1), \quad f'(\theta) > 0, \quad \int_0^1 f(s) ds > 0. \quad (5.3)$$

¹This is a joint work with François Hamel, submitted.

5. Reaction-diffusion fronts in funnel-shaped domains

The fact that f has a positive mass over $[0, 1]$ means the state 1 is in some sense more stable than 0.² A typical example of a function f satisfying (5.2)–(5.3) is the cubic nonlinearity $f(u) = u(1-u)(u-\theta)$ with $\theta \in (0, 1/2)$. For mathematical purposes, we extend f in $\mathbb{R} \setminus [0, 1]$ to a $C^{1,1}(\mathbb{R}, \mathbb{R})$ function as follows: $f(s) = f'(0)s$ for $s < 0$, and $f(s) = f'(1)(s-1)$ for $s > 1$.

One main question of interest for the solutions of (5.1) is the description of their dynamical properties as $t \rightarrow \pm\infty$. The answer to this question depends strongly on the geometry of the underlying domain Ω . In the one-dimensional real line \mathbb{R} , a prominent role is played by a class of particular solutions, namely the traveling fronts. More precisely, with assumptions (5.2)–(5.3) above, equation (5.1) in \mathbb{R} admits a unique planar traveling front $\phi(x-ct)$ solving

$$\begin{cases} \phi'' + c\phi' + f(\phi) = 0 \text{ in } \mathbb{R}, \\ \phi(-\infty) = 1, \quad \phi(+\infty) = 0, \quad 0 < \phi < 1 \text{ in } \mathbb{R}, \quad \phi(0) = \theta, \end{cases} \quad (5.4)$$

see, for instance, [9, 76, 106]. The profile ϕ is then a connection between the stable steady states 1 and 0. Moreover, $\phi' < 0$ in \mathbb{R} , and c is positive since f has a positive integral over $[0, 1]$. The traveling front $\phi(x-ct)$ is invariant in the moving frame with speed c , and it attracts as $t \rightarrow +\infty$ a large class of front-like solutions of the associated Cauchy problem, see [76]. It is also known that ϕ (resp. $1-\phi$) decays exponentially fast at $+\infty$ (resp. $-\infty$), that is,

$$\begin{cases} c_1 e^{-\mu^* z} \leq \phi(z) \leq C_1 e^{-\mu^* z}, & z \geq 0, \quad \text{with } \mu^* = \frac{c + \sqrt{c^2 - 4f'(0)}}{2} > 0, \\ c_2 e^{\mu_* z} \leq 1 - \phi(z) \leq C_2 e^{\mu_* z}, & z < 0, \quad \text{with } \mu_* = \frac{-c + \sqrt{c^2 - 4f'(1)}}{2} > 0, \end{cases} \quad (5.5)$$

where c_1, c_2, C_1 and C_2 are positive constants. The derivative $\phi'(z)$ also satisfies

$$\begin{cases} c_3 e^{-\mu^* z} \leq -\phi'(z) \leq C_3 e^{-\mu^* z}, & z \geq 0, \\ c_4 e^{\mu_* z} \leq -\phi'(z) \leq C_4 e^{\mu_* z}, & z < 0, \end{cases} \quad (5.6)$$

with positive constants c_3, c_4, C_3 and C_4 . Such planar fronts exist under the assumptions (5.2)–(5.3), whereas if f satisfies (5.2) only, fronts connecting 0 and 1 do not exist in general, see [76] for more precise conditions for the existence and non-existence. *Throughout this chapter, we assume that f satisfies (5.2)–(5.3) and that ϕ and $c > 0$ are uniquely defined as in (5.4).*

²If the integral of f over $[0, 1]$ were negative, the study would be similar, after changing u into $1-u$ and $f(s)$ into $-f(1-s)$. If the integral of f over $[0, 1]$ were equal to 0, the analysis of the propagation phenomena would be very different, since then no front connecting 0 and 1 with nonzero speed can exist in the one-dimensional version of (5.1).

5.1.1 Notations

We focus in this chapter on the case of equation (5.1) set in unbounded domains of \mathbb{R}^N , made up of a straight part and a conical part: we assume that the left (say, with respect to the direction x_1) part of Ω , namely $\Omega^- = \Omega \cap \{x \in \mathbb{R}^N : x_1 \leq 0\}$, is a straight half-cylinder in the direction $-x_1$ with cross section of radius $R > 0$, while the right part, namely $\Omega^+ = \Omega \setminus \Omega^-$, is a cone-like set with respect to the x_1 -axis and with opening angle $\alpha \geq 0$. More precisely, we assume that Ω is rotationally invariant with respect to the x_1 -axis, that is,

$$\Omega = \{x = (x_1, x') \in \mathbb{R}^N : x_1 \in \mathbb{R}, |x'| < h(x_1)\}, \quad (5.7)$$

where $|\cdot|$ denotes the Euclidean norm, and that $h : \mathbb{R} \rightarrow \mathbb{R}^+$ is a $C^{2,\beta}(\mathbb{R})$ (with $0 < \beta < 1$) function satisfying the following properties:

$$\begin{cases} 0 \leq h' \leq \tan \alpha \text{ in } \mathbb{R}, & \text{for some angle } \alpha \in [0, \pi/2), \\ h = R \text{ in } (-\infty, 0], & \text{for some radius } R > 0, \\ h(x_1) = x_1 \tan \alpha \text{ in } [L \cos \alpha, +\infty), & \text{for some } L > R, \end{cases} \quad (5.8)$$

see Figure 12. Such a domain is then called “funnel-shaped”. In the particular limit case $\alpha = 0$, the domain Ω amounts to a straight cylinder in \mathbb{R}^N with cross section of radius R . Notice that, when $\alpha > 0$, the cross section is unbounded as $x_1 \rightarrow +\infty$. To emphasize the dependence on R and α , we will also use the notation $\Omega_{R,\alpha}$ for convenience. The domains $\Omega_{R,\alpha}$ are not uniquely defined by (5.7)–(5.8), and they also depend on the parameter L in (5.8), but only the parameters $R > 0$ and $\alpha \in [0, \pi/2)$ will play an important role in our study (except in Theorem 5.9 below). Other domains which have a globally similar shape, but may be only asymptotically straight in the left part or asymptotically conical in the right part could have been considered, at the expense of less precise estimates and more technical calculations. Since the domains satisfying (5.7)–(5.8) lead to a variety of interesting and non-trivial phenomena, we restrict ourselves to (5.7)–(5.8) throughout the chapter.

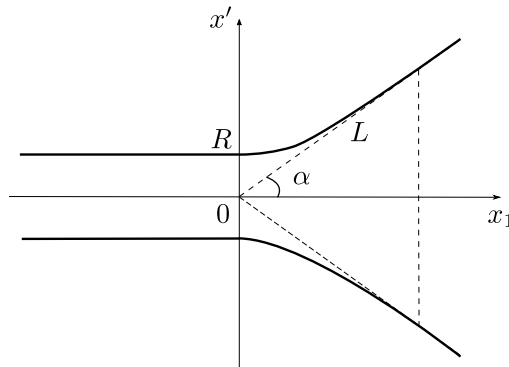

Figure 12: Schematic figure of the domain $\Omega_{R,\alpha}$ for $R > 0$ and $\alpha \in (0, \pi/2)$.

5. Reaction-diffusion fronts in funnel-shaped domains

If the domain is a straight cylinder in the direction x_1 (this happens in the case $\alpha = 0$), then the planar front $\phi(x_1 - ct)$ given by (5.4) solves (5.1) (furthermore, up to translation, any transition front connecting 0 and 1 in the sense of Definition 5.1 below is equal to that front, see [88, 92]). Here a domain $\Omega = \Omega_{R,\alpha}$ satisfying (5.7)–(5.8) is straight in its left part only, and the standard planar front $\phi(x_1 - ct)$ does not fulfill the Neumann boundary conditions when $\alpha > 0$. But it is still very natural to consider solutions of (5.1) behaving in the past like the planar front $\phi(x_1 - ct)$ coming from the left part of the domain, and to investigate the outcome of these solutions as they move into the right part of the domain. More precisely, we consider time-global solutions of (5.1) emanating from the planar front $\phi(x_1 - ct)$, that is,

$$u(t, x) - \phi(x_1 - ct) \rightarrow 0 \text{ as } t \rightarrow -\infty, \text{ uniformly with respect to } x \in \overline{\Omega} \quad (5.9)$$

(notice that, in the right part Ω^+ of Ω , this condition simply means that $u(t, \cdot) \rightarrow 0$ as $t \rightarrow -\infty$ uniformly in $\overline{\Omega^+}$). We will see that such solutions exist and are unique, and the main goal of the chapter is to study their behavior as $t \rightarrow +\infty$, in terms of the parameters R and α .

5.1.2 Background

To describe the dynamical properties of the solutions of (5.1) satisfying (5.9), we use the unifying notions of generalized traveling fronts, called transition fronts, introduced in [18, 19]. In order to recall these notions of transition fronts and that of global mean speed, let us introduce some notations. Let d_Ω be the geodesic distance in $\overline{\Omega}$ (with respect to the Euclidean distance d in \mathbb{R}^N). For any two subsets A and B of $\overline{\Omega}$, we set

$$d_\Omega(A, B) = \inf \{d_\Omega(x, y) : (x, y) \in A \times B\},$$

and $d_\Omega(x, A) = d_\Omega(\{x\}, A)$ for $x \in \overline{\Omega}$. We also use similar definitions with d , instead of d_Ω , for the Euclidean distance between subsets of \mathbb{R}^N . Consider now two families $(\Omega_t^-)_{t \in \mathbb{R}}$ and $(\Omega_t^+)_{t \in \mathbb{R}}$ of open non-empty subsets of Ω such that

$$\forall t \in \mathbb{R}, \begin{cases} \Omega_t^- \cap \Omega_t^+ = \emptyset, & \partial\Omega_t^- \cap \Omega = \partial\Omega_t^+ \cap \Omega =: \Gamma_t \neq \emptyset, & \Omega_t^- \cup \Gamma_t \cup \Omega_t^+ = \Omega, \\ \sup \{d_\Omega(x, \Gamma_t) : x \in \Omega_t^+\} = \sup \{d_\Omega(x, \Gamma_t) : x \in \Omega_t^-\} = +\infty \end{cases} \quad (5.10)$$

and

$$\begin{cases} \inf \{ \sup \{d_\Omega(y, \Gamma_t) : y \in \Omega_t^+, d_\Omega(y, x) \leq r\} : t \in \mathbb{R}, x \in \Gamma_t \} \rightarrow +\infty \\ \inf \{ \sup \{d_\Omega(y, \Gamma_t) : y \in \Omega_t^-, d_\Omega(y, x) \leq r\} : t \in \mathbb{R}, x \in \Gamma_t \} \rightarrow +\infty \end{cases} \text{ as } r \rightarrow +\infty. \quad (5.11)$$

Condition (5.11) says that for any $M > 0$, there is $r_M > 0$ such that for every $t \in \mathbb{R}$ and $x \in \Gamma_t$, there are $y^\pm = y_{t,x}^\pm \in \mathbb{R}^N$ such that

$$y^\pm \in \Omega_t^\pm, \quad d_\Omega(x, y^\pm) \leq r_M \text{ and } d_\Omega(y^\pm, \Gamma_t) \geq M. \quad (5.12)$$

In other words, any point on Γ_t is not too far from the centers of two large balls (in the sense of the geodesic distance in $\overline{\Omega}$) included in Ω_t^- and Ω_t^+ , this property being uniform with respect to t and to the point on Γ_t . Moreover, in order to avoid interfaces with infinitely many twists, the sets Γ_t are assumed to be included in finitely many graphs: there is an integer $n \geq 1$ such that, for each $t \in \mathbb{R}$, there are n open subsets $\omega_{i,t} \subset \mathbb{R}^{N-1}$ (for $1 \leq i \leq n$), n continuous maps $\psi_{i,t} : \omega_{i,t} \rightarrow \mathbb{R}$ and n rotations $R_{i,t}$ of \mathbb{R}^N with

$$\Gamma_t \subset \bigcup_{1 \leq i \leq n} R_{i,t}(\{x = (x', x_N) \in \mathbb{R}^N : x' \in \omega_{i,t}, x_N = \psi_{i,t}(x')\}). \quad (5.13)$$

Definition 5.1 [18, 19]. *For problem (5.1), a transition front connecting 1 and 0 is a classical solution $u : \mathbb{R} \times \overline{\Omega} \rightarrow (0, 1)$ for which there exist some sets $(\Omega_t^\pm)_{t \in \mathbb{R}}$ and $(\Gamma_t)_{t \in \mathbb{R}}$ satisfying (5.10)–(5.13) and for every $\varepsilon > 0$ there exists $M_\varepsilon > 0$ such that*

$$\begin{cases} \forall t \in \mathbb{R}, \forall x \in \overline{\Omega}_t^+, \quad d_\Omega(x, \Gamma_t) \geq M_\varepsilon \implies u(t, x) \geq 1 - \varepsilon, \\ \forall t \in \mathbb{R}, \forall x \in \overline{\Omega}_t^-, \quad d_\Omega(x, \Gamma_t) \geq M_\varepsilon \implies u(t, x) \leq \varepsilon. \end{cases} \quad (5.14)$$

Furthermore, u is said to have a global mean speed $\gamma \in [0, +\infty)$ if

$$\frac{d_\Omega(\Gamma_t, \Gamma_s)}{|t - s|} \rightarrow \gamma \text{ as } |t - s| \rightarrow +\infty.$$

This definition has been shown in [18, 19, 92] to cover and unify all classical cases of traveling fronts in various situations. Condition (5.14) means that the transition between the steady states 1 and 0 takes place in some uniformly-bounded-in-time neighborhoods of Γ_t . For a given transition front connecting 1 and 0, the families $(\Omega_t^\pm)_{t \in \mathbb{R}}$ and $(\Gamma_t)_{t \in \mathbb{R}}$ satisfying (5.10)–(5.14) are not unique, but the global mean speed γ , if any, does not depend on the choice of the families $(\Omega_t^\pm)_{t \in \mathbb{R}}$ and $(\Gamma_t)_{t \in \mathbb{R}}$, see [19].

Before stating the main results of this chapter, let us recall here some related works on the role of the geometry of Ω on propagation phenomena for equations of the type (5.1). It was shown in [49] that, for Ω being a succession of two semi-infinite straight cylinders with square cross sections of different sizes r and R , the solution u emanating from the planar front $\phi(x_1 - ct)$ in the left half-cylinder with smaller section and going to the right one with

5. Reaction-diffusion fronts in funnel-shaped domains

larger section can be blocked, in the sense that

$$u(t, x) \rightarrow u_\infty(x) \text{ as } t \rightarrow +\infty \text{ locally uniformly in } x \in \overline{\Omega}, \text{ with } u_\infty(x) \rightarrow 0 \text{ as } x_1 \rightarrow +\infty. \quad (5.15)$$

Later, propagation and blocking phenomena for different kinds of cylindrical domains with uniformly bounded cross sections were investigated in [11].³ Especially, if the section of the cylindrical domain is non-increasing with respect to x_1 , or if it is non-decreasing, large enough, and axially star-shaped, then the solution of (5.1) emanating from the planar front $\phi(x_1 - ct)$ propagates completely in the sense that

$$u(t, x) \rightarrow 1 \text{ as } t \rightarrow +\infty \text{ locally uniformly in } x \in \overline{\Omega}. \quad (5.16)$$

However, under some other geometrical conditions (when typically, the cross section is narrow and then becomes abruptly much wider), blocking phenomena can occur, in the sense of (5.15). Further propagation and/or blocking phenomena were also shown for bistable equations set in the real line \mathbb{R} (with periodic heterogeneities [59, 60, 66, 93, 158, 160, 164], with local defects [29, 47, 110, 127, 137, 151], or with asymptotically distinct left and right environments [68]), as well as in straight infinite cylinders with non-constant drifts [69, 70], and in some periodic domains [64] or the whole space with periodic coefficients [65, 85]. In [139], a reaction-diffusion model was considered to analyse the effects on population persistence of simultaneous changes in the position and shape of a climate envelope. In [118, 125], for a model of curvature-driven motion of plane curves in two-dimensional cylinders with undulating boundaries, various existence and non-existence results of traveling waves were proved, as well as the phenomenon of virtual pinning, that is, the propagation of waves with zero speed. Recently, the existence and characterization of the global mean speed of reaction-diffusion transition fronts in domains with multiple cylindrical branches were investigated in [88]. It was proved that the front-like solutions emanating from planar fronts in some branches and propagating completely are transition fronts moving with the planar speed c and eventually converging to planar fronts in the other branches. The classification of such fronts in domains with multiple asymptotically cylindrical branches was shown in [87].

Meanwhile, the interaction between smooth compact obstacles $K \subset \mathbb{R}^N$ and a bistable planar front $\phi(x_1 - ct)$ was studied in [20]. An entire solution $u(t, x)$ converging to $\phi(x_1 - ct)$ as $t \rightarrow -\infty$ uniformly in $\overline{\Omega} = \mathbb{R}^N \setminus \overset{\circ}{K}$ was constructed in [20]. It was also proved that if the obstacle K is star-shaped or directionally convex with respect to some hyperplane, then the solution passes the obstacle in the sense that $u(t, x)$ converges to $\phi(x_1 - ct)$ as $t \rightarrow +\infty$ uniformly in $\overline{\Omega}$. In particular, the propagation is then complete in the sense of (5.16). Furthermore, the solution is a transition front connecting 0 and 1, in the sense of Definition 5.1,

³The existence and uniqueness of time-global solutions emanating from planar fronts in more general asymptotically straight cylindrical domains was also proved in [136].

and one can choose $\Gamma_t = \{x \in \Omega = \mathbb{R}^N \setminus K : x_1 = ct\}$ in (5.10) (the transition front is then said to be almost planar). Moreover, the authors constructed non-convex obstacles K for which the solution u emanating from the bistable planar front $\phi(x_1 - ct)$ as $t \rightarrow -\infty$ does not pass the obstacle completely, in the sense that (5.16) is not fulfilled. Furthermore, it follows from [88] that all transition fronts connecting 1 and 0 propagate completely and have a global mean speed equal to the planar speed c (examples of such fronts are the almost-planar fronts given in [20] and the V -shaped fronts constructed in [89]). The solutions which do not propagate completely are still transition fronts, but they connect 0 and a steady state less than 1 in $\bar{\Omega}$, see [88].

Unlike the cylindrical domains with two branches considered in [11, 49, 69, 70] or with multiple branches considered in [87, 88], the domains $\Omega = \Omega_{R,\alpha}$ given by (5.7)–(5.8) have sections which are not uniformly bounded, as soon as $\alpha > 0$. Natural questions are to derive estimates, as $t \rightarrow +\infty$, on the location and shape of the level sets of the solutions of (5.1) satisfying (5.9), and also to know whether the solutions remain front-like in the sense of Definition 5.1. We also study in this work the role of the geometrical parameters R and α on the propagation or blocking phenomena. Since standard planar traveling fronts do not exist anymore in such domains (as soon as $\alpha > 0$), the analysis of the spreading properties of the solutions of (5.1) is much more complex than in the one-dimensional case or the case of straight cylinders. First of all, the existence and uniqueness of the entire solution u of (5.1) satisfying (5.9) is derived as in [11, 20, 136]. Then, we will show that the blocking or complete propagation properties, (5.15) or (5.16), are the only possible outcomes of the solution u at large time. We will see that u is always a transition front connecting 1 and 0 and that it has a global mean speed, equal to c , if the propagation is complete. It is worth to mention that the solution can never go ahead of the planar front $\phi(x_1 - ct)$, as that planar front is a supersolution for (5.1). We will actually show that, if $\alpha > 0$, and even if the propagation is complete, the solution lags far behind the planar front $\phi(x_1 - ct)$ in the direction of x_1 at $t \rightarrow +\infty$, in the sense that any level set of u is well approximated by the expanding spherical surface of radius $ct - ((N - 1)/c) \ln t + O(1)$ and is asymptotically locally planar. Then, we will give some sufficient conditions related to the parameters (R, α) so that u will propagate completely or be blocked. Moreover, we will also prove the openness of the set of parameters $(R, \alpha) \in (0, +\infty) \times (0, \pi/2)$ for which u propagates completely. In short, our results will then give a refined picture of the spatial shape and temporal dynamics of the level sets of front-like solutions in funnel-shaped domains, a geometrical configuration which had not been investigated before.

5.1.3 General properties for any given (R, α)

Our first result is the well-posedness of problem (5.1) with the asymptotic past condition (5.9) as $t \rightarrow -\infty$, for any given $R > 0$ and $\alpha \in [0, \pi/2)$.

5. Reaction-diffusion fronts in funnel-shaped domains

Proposition 5.2. *For any $R > 0$ and $\alpha \in [0, \pi/2)$, problem (5.1) admits a unique entire solution $u(t, x)$ emanating from the planar front $\phi(x_1 - ct)$, in the sense of (5.9). Moreover, $u_t(t, x) > 0$ and $0 < u(t, x) < 1$ for all $(t, x) \in \mathbb{R} \times \bar{\Omega}$, and there exists $u_\infty(x) = \lim_{t \rightarrow +\infty} u(t, x)$ in $C_{loc}^2(\bar{\Omega})$ satisfying $0 < u_\infty(x) \leq 1$ in $\bar{\Omega}$ and*

$$\begin{cases} \Delta u_\infty + f(u_\infty) = 0 & \text{in } \bar{\Omega}, \\ \nu \cdot \nabla u_\infty = 0 & \text{on } \partial\Omega. \end{cases} \quad (5.17)$$

Lastly, for each $t \in \mathbb{R}$, the function $u(t, \cdot)$ is axisymmetric with respect to the x_1 -axis, that is, it only depends on x_1 and $|x'|$, with $x' = (x_2, \dots, x_N)$.

From the strong maximum principle, one has either $u_\infty \equiv 1$ in $\bar{\Omega}$, or $u_\infty < 1$ in $\bar{\Omega}$. Notice also that, from (5.9) and the monotonicity in t , there holds $u_\infty(x) \rightarrow 1$ as $x_1 \rightarrow -\infty$ uniformly in $|x'| \leq R$. The proof of Proposition 5.2 follows from the construction of a sequence of Cauchy problems and of some suitable sub- and supersolutions, as in [11, 20, 68, 136]. It will be just sketched in Section 5.2.

Once the well-posedness of (5.1) with the past condition (5.9) is established, we then focus on the large time dynamics of the solution u given in Proposition 5.2. It turns out that the complete propagation in the sense of (5.16) or the blocking in the sense of (5.15) are the only two possible outcomes. Namely, we will show that the following dichotomy holds.

Theorem 5.3. *For any $R > 0$ and $\alpha \in [0, \pi/2)$, let u be the solution of (5.1) and (5.9) given in Proposition 5.2. Then, either u propagates completely in the sense of (5.16), or it is blocked in the sense of (5.15) and then the convergence of $u(t, \cdot)$ to u_∞ as $t \rightarrow +\infty$ in (5.15) is uniform in $\bar{\Omega}$.*

Remark 5.4. *When $\alpha = 0$ in (5.7)–(5.8), Ω amounts to a straight cylinder and, by uniqueness, the solution u given in Proposition 5.2 is nothing but the planar front $\phi(x_1 - ct)$, hence the propagation is complete in this very particular case.*

Theorem 5.3 means that, under the notations of Proposition 5.2, either $u_\infty \equiv 1$ in $\bar{\Omega}$, or $u_\infty(x) \rightarrow 0$ as $x_1 \rightarrow +\infty$. Any other more complex behavior is impossible. Theorem 5.3 is a consequence of the stability of the solution u_∞ and of some Liouville type results for the stable solutions of some semilinear elliptic equations in the two-dimensional plane, or in a two-dimensional half-plane, or in the whole space \mathbb{R}^N with axisymmetry. In order to give a flavor of these properties and results, which are also of independent interest, let us state here the definition of stability⁴ as well as one of the typical results shown in Section 5.3.2. So, for a non-empty open connected set $\omega \subset \mathbb{R}^N$, we say that a $C^2(\bar{\omega})$ solution U of $\Delta U + f(U) = 0$

⁴For a thorough study of stable solutions of elliptic equations, we refer to the book [67].

in $\bar{\omega}$ is stable if

$$\int_{\bar{\omega}} |\nabla \psi|^2 - f'(U)\psi^2 \geq 0 \quad (5.18)$$

for every $\psi \in C^1(\bar{\omega})$ with compact support (for instance, it turns out that the solution u_∞ of (5.17) in $\bar{\Omega}$, given in Proposition 5.2, is stable, see Lemma 5.19 below). The following result, concerned with stable axisymmetric solutions, is also shown in Section 5.3.2.

Proposition 5.5. *Let $0 \leq U \leq 1$ be a $C^2(\mathbb{R}^N)$ stable solution of $\Delta U + f(U) = 0$ in \mathbb{R}^N . Assume that U is axisymmetric with respect to the x_1 -axis, that is, U depends on x_1 and $|x'|$ only, with $x' = (x_2, \dots, x_N)$. Then, either $U \equiv 0$ in \mathbb{R}^N or $U \equiv 1$ in \mathbb{R}^N .*

Coming back to problem (5.1) in funnel-shaped domains, we then turn to the study of the spreading properties and the behavior of the level sets of the solutions under the complete propagation condition (5.16) when $\alpha \in (0, \pi/2)$. In the sequel, we denote the level sets and the upper level sets of u by:

$$\mathcal{E}_\lambda(t) = \{x \in \bar{\Omega} : u(t, x) = \lambda\}, \quad \mathcal{U}_\lambda(t) = \{x \in \bar{\Omega} : u(t, x) > \lambda\}, \quad \text{for } \lambda \in (0, 1) \text{ and } t \in \mathbb{R}. \quad (5.19)$$

Theorem 5.6. *For any $R > 0$ and $\alpha \in (0, \pi/2)$, let u be the solution of (5.1) and (5.9) given in Proposition 5.2. If u propagates completely in the sense of (5.16), then it is a transition front connecting 1 and 0 with global mean speed c , and $(\Gamma_t)_{t \in \mathbb{R}}$, $(\Omega_t^\pm)_{t \in \mathbb{R}}$ in Definition 5.1 can be defined by*

$$\begin{cases} \Gamma_t = \{x \in \Omega : x_1 = ct\} & \text{for } t \leq t_0, \\ \Gamma_t = \left\{x \in \Omega : x_1 > 0 \text{ and } |x| = ct - \frac{N-1}{c} \ln t\right\} & \text{for } t > t_0, \end{cases} \quad (5.20)$$

and

$$\begin{cases} \Omega_t^\pm = \{x \in \Omega : \pm(x_1 - ct) < 0\} & \text{for } t \leq t_0, \\ \Omega_t^+ = \left\{x \in \Omega : x_1 \leq 0, \text{ or } x_1 > 0 \text{ and } |x| < ct - \frac{N-1}{c} \ln t\right\} & \text{for } t > t_0, \\ \Omega_t^- = \left\{x \in \Omega : x_1 > 0 \text{ and } |x| > ct - \frac{N-1}{c} \ln t\right\} & \text{for } t > t_0, \end{cases} \quad (5.21)$$

with $t_0 > 0$ large enough such that $ct - ((N-1)/c) \ln t > L$ for all $t > t_0$.⁵ Moreover, u converges to planar fronts locally along its level sets as $t \rightarrow +\infty$: for any $\lambda \in (0, 1)$, any sequence $(t_n)_{n \in \mathbb{N}}$ diverging to $+\infty$ and any sequence $(x_n)_{n \in \mathbb{N}}$ in $\bar{\Omega}$ such that $u(t_n, x_n) = \lambda$, then

$$u(t + t_n, x + x_n) - \phi\left(x \cdot \frac{x_n}{|x_n|} - ct + \phi^{-1}(\lambda)\right) \longrightarrow 0 \text{ in } C_{(t,x);loc}^{1,2}(\mathbb{R} \times \mathbb{R}^N) \text{ as } n \rightarrow +\infty \quad (5.22)$$

⁵We recall that L is given in (5.8), with $L > R$.

5. Reaction-diffusion fronts in funnel-shaped domains

if $d(x_n, \partial\Omega) \rightarrow +\infty$ as $n \rightarrow +\infty$, and the same limit holds with the additional restriction $x + x_n \in \bar{\Omega}$ if $\limsup_{n \rightarrow +\infty} d(x_n, \partial\Omega) < +\infty$. Lastly, for every $\lambda \in (0, 1)$, there exists $r_0 > 0$ such that the upper level set $\mathcal{U}_\lambda(t)$ satisfies

$$S_{r(t)-r_0} \subset \mathcal{U}_\lambda(t) \subset S_{r(t)+r_0} \quad (5.23)$$

for all t large enough (see Figure 13), with S_r and $r(t)$ given by

$$S_r = \bar{\Omega}^- \cup \{x \in \bar{\Omega} : |x| \leq r\}, \quad r(t) = ct - \frac{N-1}{c} \ln t.$$

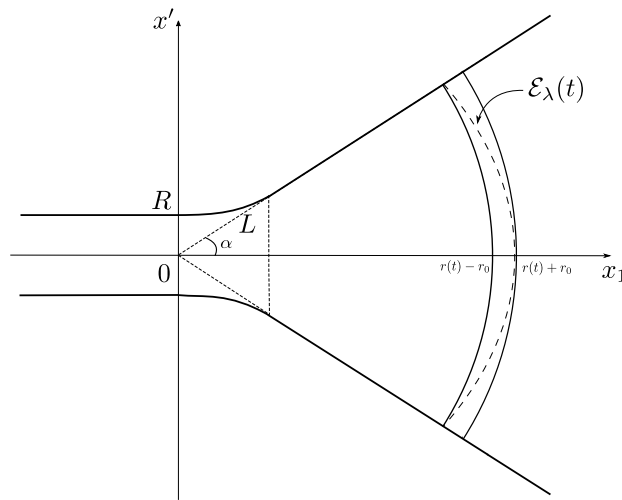

Figure 13: Possible location of the level set $\mathcal{E}_\lambda(t)$ for $\lambda \in (0, 1)$ and $t > 0$ large.

In other words, the past condition (5.9) and the complete propagation condition (5.16) guarantee the spreading of the solution u and the propagation with global mean speed c . Furthermore, the width of the transition between the limit states 1 and 0 is uniformly bounded in time in the sense of Definition 5.1 and the solution locally converges to planar fronts as $t \rightarrow +\infty$. The estimates of the location of the level sets as $t \rightarrow +\infty$ are established by constructing sub- and supersolutions whose level sets have roughly expanding spherical shapes of radii $ct - ((N-1)/c) \ln t + O(1)$, see Lemma 5.20 below. The logarithmic gap $((N-1)/c) \ln t$ is due to the curvature of the level sets, and these estimates are similar to those obtained in [154] for the solutions of the Cauchy problem in \mathbb{R}^N with compactly supported initial conditions and complete propagation. In our case, at time $t = 0$ (as at any other time), the function $x \mapsto u(t, x)$ converges to 0 as $x_1 \rightarrow +\infty$, but it then invades the right part of the domain, a situation similar to the case of invading solutions with initial compact support in \mathbb{R}^N . The proof of the asymptotic planar property is based on compactness arguments and a Liouville-type theorem for entire solutions of the bistable equation in the

whole space given in [18, Theorem 3.1].

Theorem 5.6 shows that the solutions u of Proposition 5.2 that propagate completely are transition fronts connecting 0 and 1, with global mean speed equal to c . It also turns out, this time immediately from Proposition 5.2, that the solutions u that are blocked are still transition fronts connecting 1 and 0, but they do not have any global mean speed.

Theorem 5.7. *For any $R > 0$ and $\alpha \in (0, \pi/2)$, let u be the solution of (5.1) and (5.9) given in Proposition 5.2. If u is blocked in the sense of (5.15), then it is a transition front connecting 1 and 0 without any global mean speed, and $(\Gamma_t)_{t \in \mathbb{R}}, (\Omega_t^\pm)_{t \in \mathbb{R}}$ can be defined by*

$$\begin{cases} \Gamma_t = \{x \in \Omega : x_1 = ct\} & \text{and } \Omega_t^\pm = \{x \in \Omega : \pm(x_1 - ct) < 0\} & \text{for } t \leq 0, \\ \Gamma_t = \{x \in \Omega : x_1 = 0\} & \text{and } \Omega_t^\pm = \{x \in \Omega : \pm x_1 < 0\} & \text{for } t > 0. \end{cases} \quad (5.24)$$

5.1.4 Complete propagation for large R

From now on, we investigate the effect of the parameters R and α of the funnel-shaped domains $\Omega = \Omega_{R,\alpha}$ on the propagation phenomena of the front-like solution u of (5.1) satisfying the past condition (5.9). We first recall that, when $\alpha = 0$, $u(t, x) \equiv \phi(x_1 - ct)$ and the propagation is complete, whatever $R > 0$ may be. Our next result provides some sufficient conditions on the size $R > 0$ to ensure the complete propagation condition (5.16) when $\alpha > 0$.

Theorem 5.8. *There is $R_0 > 0$ such that, if $R \geq R_0$ and $\alpha > 0$, then the unique solution u of (5.1) satisfying (5.9) propagates completely in the sense of (5.16), and therefore all the conclusions of Theorem 5.6 are valid.*

This theorem shows that the invasion always occurs no matter the size of the opening angle in the right part is, provided the left part of the domain is not too thin (see Figure 14). The proof relies on the existence of a compactly supported subsolution, with maximum larger than θ , to the elliptic problem (5.17), and on the sliding method used to compare u_∞ with some shifts of this subsolution.

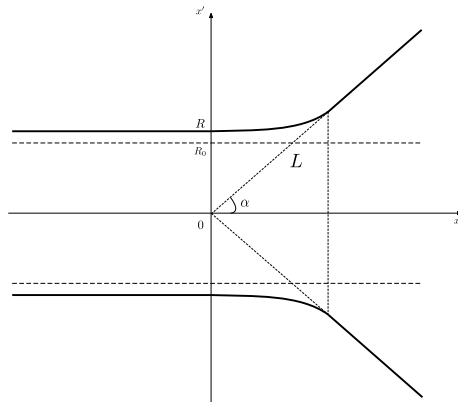

Figure 14: Schematic figure of the domain $\Omega_{R,\alpha}$ for $\alpha \in (0, \pi/2)$ and $R > R_0$.

5.1.5 Blocking for $R \ll 1$ and α not too small

The next result is concerned with blocking phenomena. We prove that the solution u of (5.1) in $\Omega_{R,\alpha}$ with past condition (5.9) is blocked if R is sufficiently small and α is sufficiently close to $\pi/2$ (see Figure 15).

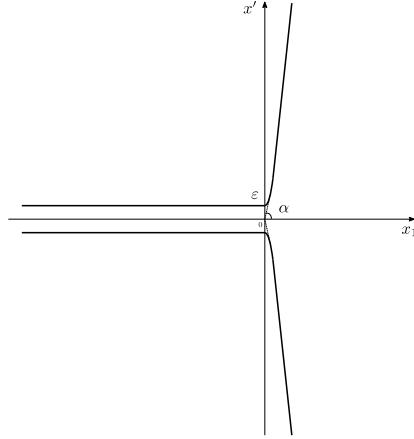

Figure 15: Schematic figure of the domain $\Omega_{\varepsilon,\alpha}$ for $R = \varepsilon \ll 1$.

Theorem 5.9. *Assume that $N \geq 3$ and let $L_* > 0$ and $\alpha_* \in (0, \pi/2)$ be given. Then there is $R_* > 0$ such that, if $0 < R \leq R_*$, $\alpha_* \leq \alpha < \pi/2$ and $L \leq L_*$ in (5.7)–(5.8), then the solution u of (5.1) in Ω with past condition (5.9) is blocked, in the sense of (5.15).*

From a biological point of view, Theorem 5.9 says that as the species goes from a very narrow passage into a suddenly wide open space, the diffusion disperses the population to lower density where the reaction behaves adversely. That prevents the species from rebuilding a strong enough basis to invade the right part of the domain. This phenomenon is similar to the problem studied in [49], although the proof given here, based on the construction of suitable supersolutions, is completely different.

Let us now make some further remarks on the effect of the geometry of the domain on invasion or blocking phenomena. In population dynamics, where u stands for the population density, one can think of the invasion of fishes from mountain streams into an endless ocean, and more generally speaking the invasion of plants or animals subject to an Allee effect and going from an isthmus into a large area. In medical sciences, the bistable reaction-diffusion equation is used to model the motion of depolarization waves in the brain, in which the domain can be thought of as a portion of grey matter of the brain with different thickness: here u represents the degree of depolarization, and the Neumann boundary condition means that the grey matter is assumed to be isolated. Equations of the type (5.1) can also be used to study ventricular fibrillations. Ventricular fibrillation is a state of electrical anarchy in part of the heart that leads to rapid chaotic contractions, which are fatal unless a normal rhythm can

be restored by defibrillation. When excitation waves enter the circular area of cardiac tissue, they are trapped and their propagation triggers off ventricular fibrillations [10]. Therefore, understanding how the geometrical properties of the cardiac fibres or fibre bundles affect or even block the propagation of excitation waves is of vital importance. For more detailed backgrounds and explanations from biological view point, we refer to [49, 11, 86] and the references therein.

5.1.6 The set of parameters (R, α) with complete propagation is open in $(0, +\infty) \times (0, \pi/2)$

In the final main result, we show that if the front-like solution u emanating from the planar traveling front satisfies the complete propagation property (5.16) in $\Omega_{R,\alpha}$ for some $R > 0$ and $\alpha \in (0, \pi/2)$, then, with a slight perturbation of R and α , the solution u will still propagate completely in the perturbed domain. For this result, we use an additional assumption on the continuous dependence of $\Omega_{R,\alpha}$ with respect to (R, α) .

Theorem 5.10. *Assume that the functions h given in (5.7)–(5.8) depend continuously on the parameters $(R, \alpha) \in (0, +\infty) \times (0, \pi/2)$ in the $C_{loc}^{2,\beta}(\mathbb{R})$ sense, with $0 < \beta < 1$. Then the set of parameters (R, α) such that the solution u of (5.1) in $\Omega_{R,\alpha}$ with past condition (5.9) propagates completely, in the sense of (5.16), is open in $(0, +\infty) \times (0, \pi/2)$.*

The continuity of the functions h given in (5.7)–(5.8) implies the local continuity of the domains $\Omega_{R,\alpha}$ in the sense of the Hausdorff distance. This continuity holds only in a local sense, since actually the Hausdorff distance between $\Omega_{R,\alpha}$ and $\Omega_{R',\alpha'}$ is infinite as soon as $\alpha \neq \alpha'$. But the local continuity is sufficient to guarantee the validity of (5.16) under small perturbations of (R, α) . The proof of Theorem 5.10 is done by way of contradiction and it uses, as that of Theorem 5.8, the existence of a compactly supported subsolution, with maximum larger than θ , to the elliptic problem (5.17).

From Theorems 5.3 and 5.10, the next corollary follows immediately.

Corollary 5.11. *Under the assumptions of Theorem 5.10, the set of parameters $(R, \alpha) \in (0, +\infty) \times (0, \pi/2)$ such that the solution u of (5.1) in $\Omega_{R,\alpha}$ with past condition (5.9) is blocked, in the sense of (5.15), is relatively closed in $(0, +\infty) \times (0, \pi/2)$.*

We finally conjecture that, under the assumptions of Theorem 5.10, the set of parameters (R, α) for which the solution u of (5.1) in $\Omega_{R,\alpha}$ with past condition (5.9) propagates completely is actually convex in both variables R and α , and that this property is stable by making α decrease or R increase. This conjecture can be formulated as follows.

Conjecture 5.12. *Assume that the functions h given in (5.7)–(5.8) depend continuously on the parameters $(R, \alpha) \in (0, +\infty) \times (0, \pi/2)$ in the $C_{loc}^{2,\beta}(\mathbb{R})$ sense, with $0 < \beta < 1$. We say*

5. Reaction-diffusion fronts in funnel-shaped domains

that complete propagation (resp. blocking) holds in $\Omega_{R,\alpha}$ if the solution u of (5.1) in $\Omega_{R,\alpha}$ with past condition (5.9) satisfies (5.16) (resp. (5.15)). Then,

- for every $R > 0$, there is $\alpha_R \in (0, \pi/2]$ such that complete propagation holds in $\Omega_{R,\alpha}$ for all $\alpha \in (0, \alpha_R)$, and blocking holds for all $\alpha \in [\alpha_R, \pi/2)$ if $\alpha_R < \pi/2$;
- for every $\alpha \in [0, \pi/2)$, there is $\rho_\alpha \in [0, +\infty)$ such that complete propagation holds in $\Omega_{R,\alpha}$ for all $R > \rho_\alpha$, and blocking holds for all $R \in (0, \rho_\alpha]$ if $\rho_\alpha > 0$;

From Theorem 5.8 one knows that α_R exists and $\alpha_R = \pi/2$ when $R \geq R_0$ (with the notations of Theorem 5.8). Furthermore, ρ_0 exists and $\rho_0 = 0$. On the other hand, Theorem 5.9 implies that, in dimension $N \geq 3$, for any given $\alpha_* \in (0, \pi/2)$ and $L_* > 0$, the angle α_R , if any, satisfies $\alpha_R \leq \alpha_*$ when $R \in (0, R_*]$ (with the notations of Theorem 5.9), and that ρ_α , if any, satisfies $\rho_\alpha \geq R_*$ when $\alpha \in [\alpha_*, \pi/2)$.

Outline of the chapter. This chapter is organized as follows. The proof of Proposition 5.2 on the existence and uniqueness of the entire solution u emanating from the planar front in the left part of a given domain Ω satisfying (5.7)–(5.8) is sketched in Section 5.2. The proof of Theorem 5.3 on the dichotomy between complete propagation and blocking is shown in Section 5.3, as are various Liouville type results for the solutions of (5.17) in funnel-shaped domains and in the whole space. Section 5.4 is devoted to the proof of Theorem 5.6 on the spreading properties in case of complete propagation. The immediate proof of Theorem 5.7 is also done in Section 5.4. In Section 5.5, we prove Theorem 5.8 on the existence of a threshold $R_0 > 0$ such that the solution u propagates completely if $R \geq R_0$, and Theorem 5.9 on blocking when R is small enough and α is not too small, by constructing a suitable stable non-constant stationary solution of (5.1). Lastly, Section 5.6 is devoted to the proof of Theorem 5.10 on the openness of the set of parameters for which complete propagation holds.

5.2 Existence and uniqueness for problem (5.1) with past condition (5.9)

This section is devoted to the sketch of the proof of Proposition 5.2 on the well-posedness of problem (5.1) in $\bar{\Omega}$ with the past condition (5.9), for any given $R > 0$ and $\alpha \in [0, \pi/2)$. From the construction of the solution of (5.1) and (5.9), we also deduce another comparison result which will be used later in the proof of Theorem 5.10. The proof of Proposition 5.2 is inspired from [20, 11, 68, 136], so we just sketch it here. However, some important elements of the construction of the solution u to (5.1) satisfying (5.9) and several auxiliary estimates are pointed out since they will be used in the proofs of other main results in the following sections.

The main steps of the proof of Proposition 5.2 are the following:

- for $\mu^* > 0$ defined as in (5.5), there exist $M > 0$ and

$$T' \leq T := \frac{1}{\mu^* c} \ln \frac{c}{c + M} < 0$$

such that the function w^- defined in $(-\infty, T] \times \bar{\Omega}$ by:

$$w^-(t, x) = \begin{cases} \phi(x_1 - ct + \xi(t)) - \phi(-x_1 - ct + \xi(t)), & t \leq T, x \in \bar{\Omega} \text{ with } x_1 < 0, \\ 0, & t \leq T, x \in \bar{\Omega} \text{ with } x_1 \geq 0, \end{cases} \quad (5.25)$$

with $\xi(t) = (1/\mu^*) \ln(c/(c - M e^{\mu^* ct}))$, is a generalized subsolution of (5.1) in $(-\infty, T] \times \bar{\Omega}$, and it satisfies (5.9) (notice that $\xi(-\infty) = 0$); furthermore, the real numbers M , T and T' can be chosen independently of $R > 0$ and $\alpha \in [0, \pi/2)$ (these coefficients depend on f and ϕ only, and thus actually on f only);

- thanks to (5.7)–(5.8), the function w^+ defined in $\mathbb{R} \times \bar{\Omega}$ by

$$w^+(t, x) = \phi(x_1 - ct) \quad (5.26)$$

is a supersolution of (5.1) in $\mathbb{R} \times \bar{\Omega}$, and it satisfies (5.9) and $w^- \leq w^+$ in $(-\infty, T] \times \bar{\Omega}$, since ϕ is positive decreasing and $\xi > 0$ in $(-\infty, T]$;

- for each $n \in \mathbb{N}$ with $n > -T'$, let u_n be the solution of the Cauchy problem associated to (5.1) in $(-n, +\infty) \times \bar{\Omega}$, with initial (at time $-n$) condition defined by

$$u_n(-n, x) = \sup_{s \leq -n} w^-(s, x) \in [0, 1], \quad \text{for } x \in \bar{\Omega}; \quad (5.27)$$

each function $u_n(-n, \cdot)$ only depends on x_1 and, from the strong parabolic maximum principle and the well-posedness of this Cauchy problem and the axisymmetry of Ω with respect to the x_1 -axis, one has $0 < u_n < 1$ in $(-n, +\infty) \times \bar{\Omega}$ and, for each $t \geq -n$, $u_n(t, \cdot)$ is axisymmetric with respect to the x_1 -axis, that is, it depends only on x_1 and $|x'|$, with $x' = (x_2, \dots, x_N)$; furthermore, the maximum principle again and the fact that w^- is a subsolution in $(-\infty, T'] \times \bar{\Omega}$, imply that $u_n(t, \cdot) \geq u_n(-n, \cdot)$ in $\bar{\Omega}$ for all $t \in [-n, T']$, hence u_n is non-decreasing with respect to the variable t in $[-n, +\infty) \times \bar{\Omega}$;

- the maximum principle also implies that $u_{n+1}(-n, \cdot) \geq u_n(-n, \cdot)$ in $\bar{\Omega}$ for each $n > -T'$, hence $u_{n+1} \geq u_n$ in $[-n, +\infty) \times \bar{\Omega}$ for each $n > -T'$; from standard parabolic estimates, the functions u_n converge in $C_{(t,x);loc}^{1,2}(\mathbb{R} \times \bar{\Omega})$ to a classical solution u of (5.1) such that $0 \leq u \leq 1$ and $u_t \geq 0$ in $\mathbb{R} \times \bar{\Omega}$; furthermore, for each $t \in \mathbb{R}$, the function $u(t, \cdot)$ is axisymmetric with respect to the x_1 -axis;
- one has $1 \geq u_n(-n, \cdot) \geq w^-(-n, \cdot)$ in $\bar{\Omega}$ for each $n > -T'$, hence $1 \geq u_n(t, \cdot) \geq w^-(t, \cdot)$

5. Reaction-diffusion fronts in funnel-shaped domains

in $\bar{\Omega}$ for all $t \in [-n, T']$ and

$$1 \geq u(t, \cdot) \geq w^-(t, \cdot) \quad \text{in } \bar{\Omega} \text{ for all } t \leq T'; \quad (5.28)$$

- since $w^- \leq w^+$ in $(-\infty, T'] \times \bar{\Omega}$ and w^+ is increasing with respect to the variable t , one has $u_n(-n, \cdot) \leq w^+(-n, \cdot)$ in $\bar{\Omega}$ for each $n > -T'$, hence $u_n(t, \cdot) \leq w^+(t, \cdot)$ in $\bar{\Omega}$ for all $t \geq -n$, and

$$u(t, x) \leq w^+(t, x) = \phi(x_1 - ct) \quad \text{for all } (t, x) \in \mathbb{R} \times \bar{\Omega}; \quad (5.29)$$

- from the inequalities $w^- \leq u \leq w^+$ in $(-\infty, T'] \times \bar{\Omega}$, the past condition (5.9) follows immediately; one also gets that

$$0 < u < 1 \quad \text{and} \quad u_t > 0 \quad \text{in } \mathbb{R} \times \bar{\Omega}$$

from the strong parabolic maximum principle;

- from standard parabolic estimates and the monotonicity in t , one has $u(t, \cdot) \rightarrow u_\infty$ as $t \rightarrow +\infty$ in $C_{loc}^2(\bar{\Omega})$, and $0 < u_\infty \leq 1$ solves (5.17); furthermore, $1 \geq u_\infty(x) > u(t, x) \geq w^-(t, x)$ for all $(t, x) \in (-\infty, T'] \times \bar{\Omega}$; in particular,

$$1 \geq u_\infty(x) \geq w^-(T', x) = \phi(x_1 - cT' + \xi(T')) - \phi(-x_1 - cT' + \xi(T'))$$

for all $x \in \bar{\Omega}$ with $x_1 < 0$; since ξ and T' do not depend on $R > 0$ and $\alpha \in [0, \pi/2)$, one gets that

$$u_\infty(x) \rightarrow 1 \quad \text{as } x_1 \rightarrow -\infty \quad \text{uniformly with respect to } R > 0 \text{ and } \alpha \in [0, \pi/2); \quad (5.30)$$

- for each $\eta \in (0, 1/2)$, the past condition (5.9) and the monotonicity of u in t , together with the strong parabolic maximum principle, yield $\liminf_{t \rightarrow -\infty, u(t, x) \in [\eta, 1-\eta]} u_t(t, x) > 0$;
- for any solution v of (5.1) satisfying (5.9), there are $\beta > 0$ and $\sigma > 0$ such that, for every $\varepsilon > 0$ small enough, there is $T_\varepsilon < 0$ such that $v < u + \varepsilon$ in $(-\infty, T_\varepsilon] \times \bar{\Omega}$ and the function

$$(t, x) \mapsto \min(u(t + \sigma\varepsilon(1 - e^{-\beta(t-t_0)}), x) + \varepsilon e^{-\beta(t-t_0)}, 1)$$

is a supersolution of (5.1) in $[t_0, T_\varepsilon] \times \bar{\Omega}$ for all $t_0 < T_\varepsilon$; as this supersolution is larger than v at time t_0 , with any $t_0 < T_\varepsilon$, so is it in $[t_0, T_\varepsilon] \times \bar{\Omega}$, hence $u(t + \sigma\varepsilon, x) \geq v(t, x)$ in $(-\infty, T_\varepsilon] \times \bar{\Omega}$ at the limit $t_0 \rightarrow -\infty$, and finally $v \leq u(\cdot + \sigma\varepsilon, \cdot)$ in $\mathbb{R} \times \bar{\Omega}$ from the comparison principle; since this holds for all $\varepsilon > 0$ small enough, one gets $v \leq u$ in $\mathbb{R} \times \bar{\Omega}$; similarly, the inequality $v \geq u$ holds, leading to the uniqueness for problem (5.1) with the past condition (5.9).

This completes the proof of Proposition 5.2. □

From the proof of Proposition 5.2, an important corollary follows, that will be used later in the proof of Theorem 5.10.

Corollary 5.13. *For any $R > 0$ and $\alpha \in [0, \pi/2)$, let u be the solution of (5.1) and (5.9) given in Proposition 5.2. If there is a $C^2(\overline{\Omega})$ solution U of the elliptic problem (5.17) such that $0 < U \leq 1$ in $\overline{\Omega}$ and $U(x) \rightarrow 1$ as $x_1 \rightarrow -\infty$, then $u(t, x) \leq U(x)$ for all $(t, x) \in \mathbb{R} \times \overline{\Omega}$.*

Proof. We recall that $f(1) = 0$, $f'(1) < 0$, and f is extended by $f(s) = f'(1)(s-1)$ for $s > 1$. Let $\delta > 0$ be such that $f' < 0$ in $[1 - \delta, +\infty)$, and let $A > 0$ be such that

$$1 - \delta \leq U(x) \leq 1 \quad \text{for all } x \in \overline{\Omega} \text{ with } x_1 \leq -A. \quad (5.31)$$

Since U is positive and continuous in $\overline{\Omega}$, it follows from the definitions of Ω and w^- in (5.7)–(5.8) and (5.25) that there exists $T_1 \in (-\infty, T'] \subset (-\infty, T] \subset (-\infty, 0)$ such that

$$w^-(t, x) \leq U(x) \quad \text{for all } t \leq T_1 \text{ and } x \in \overline{\Omega} \text{ with } x_1 \geq -A. \quad (5.32)$$

We now claim that $w^-(t, x) \leq U(x)$ for all $t \leq T_1$ and $x \in \overline{\Omega}$, an inequality that will easily lead to the desired conclusion. To show this inequality, define

$$\varepsilon^* = \min \{ \varepsilon \geq 0 : w^-(t, x) \leq U(x) + \varepsilon \text{ for all } t \leq T_1 \text{ and } x \in \overline{\Omega} \}.$$

Since w^- and U are globally bounded and continuous, ε^* is a well-defined nonnegative real number, and one has $w^-(t, x) \leq U(x) + \varepsilon^*$ for all $t \leq T_1$ and $x \in \overline{\Omega}$. One shall show that $\varepsilon^* = 0$. Assume by way of contradiction that $\varepsilon^* > 0$. Notice that $w^-(t, \cdot) \rightarrow 0$ as $t \rightarrow -\infty$ locally uniformly in $\overline{\Omega}$, and remember that $w^- \leq 1$ in $(-\infty, T_1] \times \overline{\Omega}$ and $U > 0$ in $\overline{\Omega}$ with $\lim_{x_1 \rightarrow -\infty} U(x) = 1$. It then follows from (5.32) and the definition of ε^* that there is $(t^*, x^*) \in (-\infty, T_1] \times \overline{\Omega}$ with $x_1^* < -A$ such that

$$w^-(t^*, x^*) = U(x^*) + \varepsilon^*.$$

But the function $U + \varepsilon^*$ is a supersolution of (5.17) in $\{x \in \overline{\Omega} : x_1 \leq -A\}$, owing to (5.31) and the definitions of δ and A (one has $f(U(x) + \varepsilon^*) \leq f(U(x))$ for all $x \in \overline{\Omega}$ with $x_1 \leq -A$). On the other hand, the function w^- is a generalized subsolution of (5.1) in $(-\infty, T_1] \times \overline{\Omega}$ (remember that $T_1 \leq T'$). The strong parabolic maximum principle (namely, the interior version if $x^* \in \Omega$ with $x_1^* < -A$, or the strong parabolic Hopf lemma if $x^* \in \partial\Omega$, still with $x_1^* < -A$) then imply that $w^-(t, x) = U(x) + \varepsilon^*$ for all $t \leq t^*$ and $x \in \overline{\Omega}$ with $x_1 \leq -A$. This is clearly ruled out, since $w^- \leq 1$ and $U(x) + \varepsilon^* \rightarrow 1 + \varepsilon^* > 1$ as $x_1 \rightarrow -\infty$. Therefore, $\varepsilon^* = 0$, hence

$$w^-(t, x) \leq U(x) \quad \text{for all } t \leq T_1 \text{ and } x \in \overline{\Omega}.$$

In particular, owing to (5.27), there holds $u_n(-n, \cdot) = \sup_{s \leq -n} w^-(s, \cdot) \leq U$ in $\bar{\Omega}$ for all $n \in \mathbb{N}$ with $n \geq -T_1$. Hence, from the parabolic maximum principle, one has $u_n(t, \cdot) \leq U$ in $\bar{\Omega}$ for all $n \in \mathbb{N}$ with $n \geq -T_1$ and for all $t \geq -n$. Therefore, $u(t, \cdot) \leq U$ in $\bar{\Omega}$ for all $t \in \mathbb{R}$, which is the desired conclusion. \square

5.3 Dichotomy between complete propagation and blocking

This section is devoted to the proof of the dichotomy between complete propagation and blocking for the solutions u of (5.1) and (5.9) constructed in Proposition 5.2, for any given $R > 0$ and $\alpha \in [0, \pi/2)$. The proof of this dichotomy relies itself on several Liouville type results of independent interest for the solutions of elliptic equations $\Delta U + f(U) = 0$ in certain domains of \mathbb{R}^N . We start in Section 5.3.1 with Liouville type results for (5.17) in funnel-shaped domains Ω , and we then continue in Section 5.3.2 with such results for stable solutions of $\Delta U + f(U) = 0$ in the plane, a half-plane and the whole space. Theorem 5.3 is finally proved in Section 5.3.3.

5.3.1 Auxiliary Liouville type results for (5.17) in funnel-shaped domains

The first two auxiliary Liouville type results used in the proof of Theorem 5.3, as well as in other main results, are Lemmas 5.15 and 5.16 below for the solutions u_∞ of (5.17) in funnel-shaped domains Ω . They rely themselves on the existence of some not-too-small solutions of the same equation in large balls with Dirichlet boundary conditions. In the sequel, we call $B_r(x)$ the open Euclidean ball of center $x \in \mathbb{R}^N$ and radius $r > 0$, and we denote $B_r := B_r(0)$.

Lemma 5.14. *There are $R_0 > 0$ and a $C^2(\overline{B_{R_0}})$ solution ψ of the semilinear elliptic equation*

$$\begin{cases} \Delta\psi + f(\psi) = 0 & \text{in } \overline{B_{R_0}}, \\ 0 \leq \psi < 1 & \text{in } \overline{B_{R_0}}, \\ \psi = 0 & \text{on } \partial B_{R_0}, \\ \max_{\overline{B_{R_0}}} \psi = \psi(0) > \theta. \end{cases} \quad (5.33)$$

Proof. The proof is standard and is therefore omitted. In short, it can be done by using variational arguments (see e.g. [26, Theorem A] and [88, Problem (2.25)]): such a solution ψ is obtained as a minimizer in $H_0^1(B_{R_0})$ of the functional $\varphi \mapsto \int_{B_{R_0}} |\nabla\varphi|^2/2 - \int_{B_{R_0}} F(\varphi)$, with $F' = f$. Furthermore, such a minimizer is radially symmetric and decreasing in $|x|$ as soon as it is

5.3. Dichotomy between complete propagation and blocking

not identically 0 (see [82]), and its maximal value, which is the value at the origin, converges to 1 as the radius of the ball converges to $+\infty$, thanks to (5.2)–(5.3). \square

In Proposition 5.2, the constructed solutions u of (5.1) and (5.9) converge as $t \rightarrow +\infty$ to a stationary solution u_∞ of (5.17). By construction, u_∞ satisfies $0 < u_\infty \leq 1$ in $\bar{\Omega}$, and $u_\infty(x) \rightarrow 1$ as $x_1 \rightarrow -\infty$ (and this limit actually holds uniformly with respect to the parameters (R, α)). But this limit is not enough to guarantee that $u_\infty \equiv 1$ in $\bar{\Omega}$ in general: Theorems 5.8 and 5.9 provide some conditions for u_∞ to be equal to 1 or not, according to the values of R and α . We now prove in the next result (which will be used in the proof of Theorem 5.3) that, whatever R and α may be, if $u_\infty(x)$ is assumed to converge to 1 (or is assumed to be not too small) as $x_1 \rightarrow +\infty$, then u_∞ is identically equal to 1.

Lemma 5.15. *Let Ω be a funnel-shaped domain satisfying (5.7)–(5.8), and let $0 < u_\infty \leq 1$ be a solution of (5.17) in $\bar{\Omega}$. If $\liminf_{x \in \bar{\Omega}, x_1 \rightarrow +\infty} u_\infty(x) > \theta$ with θ as in (5.3), then $u_\infty \equiv 1$ in $\bar{\Omega}$.*

Proof. First of all, if $(x^n)_{n \in \mathbb{N}} = (x_1^n, x_2^n, \dots, x_N^n)_{n \in \mathbb{N}} = (x_1^n, (x^n)')_{n \in \mathbb{N}}$ is any sequence in $\bar{\Omega}$ such that $x_1^n \rightarrow +\infty$ and $h(x_1^n) - |(x^n)'| \rightarrow +\infty$ as $n \rightarrow +\infty$, then, from standard elliptic estimates, the functions $x \mapsto u_\infty(x + x^n)$ converge in $C_{loc}^2(\mathbb{R}^N)$, up to extraction of a subsequence, to a $C^2(\mathbb{R}^N)$ solution U of

$$\Delta U + f(U) = 0 \quad \text{in } \mathbb{R}^N,$$

such that $\theta < \inf_{\mathbb{R}^N} U \leq \sup_{\mathbb{R}^N} U \leq 1$. Since $f(1) = 0$ and $f > 0$ in $(\theta, 1)$, it then easily follows that $U \equiv 1$ in \mathbb{R}^N . Similarly, if $(x^n)_{n \in \mathbb{N}}$ is any sequence in $\bar{\Omega}$ such that $x_1^n \rightarrow +\infty$ and $\limsup_{n \rightarrow +\infty} (h(x_1^n) - |(x^n)'|) < +\infty$, then there are an open half-space H of \mathbb{R}^N and a $C^2(\bar{H})$ function U such that, up to extraction of a subsequence, $\|u_\infty(\cdot + x^n) - U\|_{C^2(K \cap (\bar{\Omega} - x^n))} \rightarrow 0$ as $n \rightarrow +\infty$ for every compact set $K \subset \bar{H}$. Hence, U obeys $\Delta U + f(U) = 0$ in \bar{H} and $\nu \cdot \nabla U = 0$ on ∂H , together with $\theta < \inf_H U \leq \sup_H U \leq 1$. As above, one infers that $U \equiv 1$ in \bar{H} . From the previous observations, it follows that

$$u_\infty(x) \rightarrow 1 \quad \text{as } x_1 \rightarrow +\infty$$

with $x \in \bar{\Omega}$, that is, uniformly with respect to the variables (x_2, \dots, x_N) .

Now, from (5.2)–(5.3) and the affine C^1 extension of f outside $[0, 1]$, there is $\varepsilon > 0$ small enough such that the $C^1(\mathbb{R})$ function $f - \varepsilon$ satisfies $f(\alpha_\varepsilon) - \varepsilon = f(\theta_\varepsilon) - \varepsilon = f(\beta_\varepsilon) - \varepsilon = 0$ for some

$$\alpha_\varepsilon < 0 < \theta < \theta_\varepsilon < \beta_\varepsilon < 1,$$

with $f'(\alpha_\varepsilon) < 0$, $f'(\theta_\varepsilon) > 0$, $f'(\beta_\varepsilon) < 0$, $f - \varepsilon < 0$ in $(\alpha_\varepsilon, \theta_\varepsilon)$, $f - \varepsilon > 0$ in $(\theta_\varepsilon, \beta_\varepsilon)$, and $\int_{\alpha_\varepsilon}^{\beta_\varepsilon} (f - \varepsilon) > 0$. Therefore, there exist $c_\varepsilon > 0$ and a $C^2(\mathbb{R})$ function $\phi_\varepsilon : \mathbb{R} \rightarrow (\alpha_\varepsilon, \beta_\varepsilon)$ solving

$$\phi_\varepsilon'' + c_\varepsilon \phi_\varepsilon' + f(\phi_\varepsilon) - \varepsilon = 0 \quad \text{in } \mathbb{R}, \quad \text{and } \phi_\varepsilon(-\infty) = \beta_\varepsilon, \quad \phi_\varepsilon(+\infty) = \alpha_\varepsilon.$$

5. Reaction-diffusion fronts in funnel-shaped domains

Since u_∞ is positive in $\overline{\Omega}$ and converges to 1 as $x_1 \rightarrow +\infty$, there exists $A > 0$ such that $u_\infty(x) \geq \phi_\varepsilon(-x_1 + A)$ for all $x \in \overline{\Omega}$. But the function ϕ_ε is decreasing in \mathbb{R} and the function h in (5.8) is nondecreasing. Hence, for each $t \in \mathbb{R}$, the function $x \mapsto \phi_\varepsilon(-x_1 - c_\varepsilon t + A)$ has a nonpositive normal derivative at any point $x \in \partial\Omega$. Furthermore, $\underline{u}(t, x) := \phi_\varepsilon(-x_1 - c_\varepsilon t + A)$ satisfies $\underline{u}_t = \Delta \underline{u} + f(\underline{u}) - \varepsilon \leq \Delta \underline{u} + f(\underline{u})$ in $\mathbb{R} \times \mathbb{R}^N$ by definition of ϕ_ε . Remembering that $u_\infty \geq \underline{u}(0, \cdot)$ in $\overline{\Omega}$, the parabolic maximum principle then implies that $u_\infty \geq \underline{u}(t, \cdot)$ in $\overline{\Omega}$ for all $t \geq 0$. The limit as $t \rightarrow +\infty$ and the positivity of c_ε yield

$$u_\infty \geq \phi_\varepsilon(-\infty) = \beta_\varepsilon \quad \text{in } \overline{\Omega}.$$

Since $\theta < \beta_\varepsilon \leq u_\infty \leq 1$ and $f > 0$ in $(\theta, 1)$, one then gets that $u_\infty \equiv 1$ in $\overline{\Omega}$, which is the desired conclusion. \square

The next result, which can be viewed as a corollary of Lemmas 5.14 and 5.15, will also be a key-ingredient in the proof of Theorems 5.8 and 5.10.

Lemma 5.16. *Let Ω be a funnel-shaped domain satisfying (5.7)–(5.8), and let $0 < u_\infty \leq 1$ be a $C^2(\overline{\Omega})$ solution of (5.17) in $\overline{\Omega}$. Let $R_0 > 0$ and $\psi \in C^2(\overline{B_{R_0}})$ be as in Lemma 5.14. If there is a point $x_0 \in \Omega$ such that $\overline{B_{R_0}(x_0)} \subset \overline{\Omega}$ and $u_\infty \geq \psi(\cdot - x_0)$ in $\overline{B_{R_0}(x_0)}$, then $u_\infty \equiv 1$ in $\overline{\Omega}$.*

Proof. Write

$$x_0 = (x_{0,1}, x'_0)$$

with $x_{0,1} \in \mathbb{R}$ and $x'_0 \in \mathbb{R}^{N-1}$. Owing to the properties (5.7)–(5.8) satisfied by Ω , one has $\overline{B_{R_0}(x_{0,1}, sx'_0)} \subset \overline{\Omega}$ for all $s \in [0, 1]$. Since ψ satisfies (5.33) and vanishes on ∂B_{R_0} , and since the solution u_∞ of (5.17) is positive in $\overline{\Omega}$, the strong maximum principle implies that $u_\infty > \psi(\cdot - x_0)$ in $\overline{B_{R_0}(x_0)}$ and, by continuity, $u_\infty > \psi(\cdot - (x_{0,1}, sx'_0))$ in $\overline{B_{R_0}(x_{0,1}, sx'_0)}$ for all $s \in [\eta, 1]$, for some $0 \leq \eta < 1$. We then claim that

$$u_\infty > \psi(\cdot - (x_{0,1}, sx'_0)) \quad \text{in } \overline{B_{R_0}(x_{0,1}, sx'_0)} \quad \text{for all } s \in [0, 1]. \quad (5.34)$$

Indeed, otherwise, there exists $s^* \in [0, 1)$ such that $u_\infty \geq \psi(\cdot - (x_{0,1}, s^*x'_0))$ in $\overline{B_{R_0}(x_{0,1}, s^*x'_0)}$ with equality at a point $x^* \in \overline{B_{R_0}(x_{0,1}, s^*x'_0)}$. The point x^* can not lie on the boundary $\partial B_{R_0}(x_{0,1}, s^*x'_0)$, since $\psi(\cdot - (x_{0,1}, s^*x'_0))$ vanishes there whereas u_∞ is positive. Hence, x^* is in the open ball $B_{R_0}(x_{0,1}, s^*x'_0)$ and the strong maximum principle yields $u_\infty \equiv \psi(\cdot - (x_{0,1}, s^*x'_0))$ in $\overline{B_{R_0}(x_{0,1}, s^*x'_0)}$, which is impossible on $\partial B_{R_0}(x_{0,1}, s^*x'_0)$. Therefore, (5.34) holds and, in particular, $u_\infty > \psi(\cdot - (x_{0,1}, 0))$ in $\overline{B_{R_0}(x_{0,1}, 0)}$.

Similarly, since $\overline{B_{R_0}(s, 0)} \subset \overline{\Omega}$ for all $s \geq x_{0,1}$, one then infers that $u_\infty > \psi(\cdot - (s, 0))$ in $\overline{B_{R_0}(s, 0)}$ for all $s \geq x_{0,1}$. Consider then any

$$s \geq \max(x_{0,1}, L \cos \alpha + R_0),$$

5.3. Dichotomy between complete propagation and blocking

with $L > R > 0$ and $\alpha \in [0, \pi/2)$ given in (5.8), and any unit vector e' of \mathbb{R}^{N-1} . For each $\sigma \in [0, h(s)]$, two cases may occur, owing to (5.7)–(5.8):

$$\left\{ \begin{array}{l} \text{either } \overline{B_{R_0}(s, \sigma e')} \subset \overline{\Omega}, \\ \text{or } B_{R_0}(s, \sigma e') \cap \partial\Omega \neq \emptyset \text{ and } \nu(x) \cdot (x - (s, \sigma e')) \geq 0 \text{ for every } x \in B_{R_0}(s, \sigma e') \cap \partial\Omega, \end{array} \right.$$

where $\nu(x)$ denotes the outward unit normal to Ω at x . In the latter case, one then has $\nu(x) \cdot \nabla\psi(x - (s, \sigma e')) \leq 0$, since the function $y \mapsto \psi(y)$ is radially symmetric and nonincreasing with respect to $|y|$ in $\overline{B_{R_0}}$. In all cases, for each $\sigma \in [0, h(s)]$, the function $\psi(\cdot - (s, \sigma e'))$ is a subsolution of (5.17) in $\overline{B_{R_0}(s, \sigma e') \cap \Omega}$ (this closed set is actually equal to $\overline{B_{R_0}(s, \sigma e') \cap \Omega}$ from the definition of Ω , since $\sigma \in [0, h(s)]$), and the open set $B_{R_0}(s, \sigma e') \cap \Omega$ is connected and not empty, with its boundary meeting $\partial B_{R_0}(s, \sigma e') \cap \overline{\Omega}$. Hence, the function $\psi(\cdot - (s, \sigma e'))$ can not be identically equal to u_∞ in $\overline{B_{R_0}(s, \sigma e') \cap \Omega}$. Since $u_\infty > \psi(\cdot - (s, 0))$ in $\overline{B_{R_0}(s, 0)}$, one then gets as in the previous paragraph, by sliding ψ below u_∞ in the direction $(0, e')$ and using the strong interior maximum principle and the Hopf lemma, that $u_\infty > \psi(\cdot - (s, \sigma e'))$ in $\overline{B_{R_0}(s, \sigma e') \cap \Omega}$ for all $\sigma \in [0, h(s)]$. As a consequence,

$$u_\infty(s, \sigma e') > \psi(0) \quad \text{for all } s \geq \max(x_{0,1}, L \cos \alpha + R_0) \text{ and } \sigma \in [0, h(s)].$$

Since this holds for every unit vector e' of \mathbb{R}^{N-1} , one infers that $u_\infty(x) > \psi(0)$ for all $x \in \overline{\Omega}$ with $x_1 \geq \max(x_{0,1}, L \cos \alpha + R_0)$. Since $u_\infty \leq 1$ in $\overline{\Omega}$ together with $\psi(0) > \theta$, one concludes from Lemma 5.15 that $u_\infty \equiv 1$ in $\overline{\Omega}$. The proof of Lemma 5.16 is thereby complete. \square

5.3.2 Auxiliary Liouville type results for stable solutions of $\Delta U + f(U) = 0$

The last three auxiliary results for the proof of Theorem 5.3 are still Liouville type results for semilinear elliptic equations $\Delta U + f(U) = 0$ in $\overline{\omega}$. But these results, of independent interest, deal with other geometric configurations: ω will be the two-dimensional plane, or a two-dimensional half-plane, or the whole space \mathbb{R}^N . In all these statements, we are concerned with stable solutions, in the sense of (5.18).

Proposition 5.17. *Let $0 \leq U \leq 1$ be a $C^2(\mathbb{R}^2)$ stable solution of $\Delta U + f(U) = 0$ in \mathbb{R}^2 . Then, either $U \equiv 0$ in \mathbb{R}^2 or $U \equiv 1$ in \mathbb{R}^2 .*

Proof. The proof uses some properties of the principal eigenvalues of some elliptic operators, together with some results of [12]. First of all, since $f \in C^{1,1}([0, 1])$, standard elliptic estimates imply that U is of class $C^3(\mathbb{R}^2)$ and has bounded partial derivatives up to the third order.

5. Reaction-diffusion fronts in funnel-shaped domains

Now, for any $R > 0$, let

$$\lambda(-\Delta - f'(U), B_R) = \min_{\psi \in H_0^1(B_R), \|\psi\|_{L^2(B_R)}=1} \int_{B_R} |\nabla \psi|^2 - f'(U)\psi^2 \quad (5.35)$$

and

$$\lambda(-\Delta, B_R) = \min_{\psi \in H_0^1(B_R), \|\psi\|_{L^2(B_R)}=1} \int_{B_R} |\nabla \psi|^2$$

be the principal eigenvalues of the operators $-\Delta - f'(U)$ and $-\Delta$ in B_R (the two-dimensional Euclidean disc) with Dirichlet boundary conditions on ∂B_R . One has $\lambda(-\Delta - f'(U), B_R) \geq 0$ by assumption, and

$$\lambda(-\Delta - f'(U), B_R) \leq \max_{[0,1]} |f'| + \lambda(-\Delta, B_R) = \max_{[0,1]} |f'| + \frac{\lambda(-\Delta, B_1)}{R^2}.$$

Hence $\sup_{R \geq 1} |\lambda(-\Delta - f'(U), B_R)| < +\infty$. Furthermore, the map $R \mapsto \lambda(-\Delta - f'(U), B_R)$ is nonincreasing (and even actually decreasing) in $(0, +\infty)$, and there exists

$$\lambda_\infty = \lim_{R \rightarrow +\infty} \lambda(-\Delta - f'(U), B_R) \in [0, +\infty).$$

Notice also that the map $x \mapsto f'(U(x))$ is Lipschitz continuous from the $C^{1,1}$ regularity of f and the Lipschitz continuity of U . For each $n \in \mathbb{N}$ with $n \geq 1$, there exists a unique principal eigenfunction $\varphi_n \in C^2(\overline{B_n})$ solving

$$-\Delta \varphi_n - f'(U)\varphi_n = \lambda(-\Delta - f'(U), B_n)\varphi_n \quad \text{in } \overline{B_n},$$

with $\varphi_n = 0$ on ∂B_n , $\varphi_n > 0$ in B_n and $\varphi_n(0) = 1$. The Harnack inequality and standard elliptic estimates then imply that, up to extraction of a subsequence, the functions φ_n converge in $C_{loc}^2(\mathbb{R}^2)$ to a positive function φ solving $-\Delta \varphi - f'(U)\varphi = \lambda_\infty \varphi \geq 0$ in \mathbb{R}^2 (together with $\varphi(0) = 1$). Since the space dimension is here equal to 2, and since each function $e \cdot \nabla U$ (with a unit vector e of \mathbb{R}^2) is bounded in \mathbb{R}^2 and solves

$$\Delta(e \cdot \nabla U) + f'(U)(e \cdot \nabla U) = 0 \quad \text{in } \mathbb{R}^2,$$

it follows from [12, Theorem 1.8] that $e \cdot \nabla U \equiv C_e \varphi$ in \mathbb{R}^2 for some real number C_e . In particular, each partial derivative $e \cdot \nabla U$ is either identically 0 or has a strict constant sign in \mathbb{R}^2 . As a consequence, either the function U is constant, or it depends on one variable only and it is strictly monotone in that variable.

If U is constant, it may be equal to 0, θ or 1, from (5.2)–(5.3). However, if U were equal

to θ , then

$$0 \leq \lambda(-\Delta - f'(U), B_R) = -f'(\theta) + \lambda(-\Delta, B_R) = -f'(\theta) + R^{-2}\lambda(-\Delta, B_1) \xrightarrow{R \rightarrow +\infty} -f'(\theta) < 0,$$

a contradiction. Thus, if U is constant, then either $U \equiv 0$ or $U \equiv 1$ in \mathbb{R}^2 .

If U were one-dimensional and strictly monotone, that is $U(x) = V(x \cdot e)$ for some unit vector e and V increasing in \mathbb{R} , then V would solve $V'' + f(V) = 0$ in \mathbb{R} with $(V(-\infty), V(+\infty)) \in \{(0, \theta), (0, 1), (\theta, 1)\}$, but the integration of this equation against V' over \mathbb{R} would lead to $\int_{V(-\infty)}^{V(+\infty)} f(s)ds = 0$, contradicting (5.2)–(5.3). Thus, this monotone one-dimensional case is ruled out.

As a conclusion, one has shown that U is constant in \mathbb{R}^2 , and identically equal to 0 or 1. The proof of Proposition 5.17 is thereby complete. \square

From Proposition 5.17, the following analogue in a half-plane easily follows.

Proposition 5.18. *Let H be an open half-plane and let $0 \leq U \leq 1$ be a $C^2(\overline{H})$ stable solution of $\Delta U + f(U) = 0$ in \overline{H} with Neumann boundary condition $\nu \cdot \nabla U = 0$ on ∂H . Then, either $U \equiv 0$ in \overline{H} or $U \equiv 1$ in \overline{H} .*

Proof. Up to translation and rotation, one can assume that $H = \{(x_1, x_2) \in \mathbb{R}^2 : x_2 < 0\}$ without loss of generality. Thus, $\partial H = \mathbb{R} \times \{0\}$ and $\partial_{x_2} U(x_1, 0) = 0$ for all $x_1 \in \mathbb{R}$. Consider now the function V in \mathbb{R}^2 defined by

$$V(x_1, x_2) = \begin{cases} U(x_1, x_2) & \text{if } x_2 \leq 0, \\ U(x_1, -x_2) & \text{if } x_2 > 0. \end{cases}$$

It is of class $C^2(\mathbb{R}^2)$ and it solves $\Delta V + f(V) = 0$ in \mathbb{R}^2 , together with $0 \leq V \leq 1$ in \mathbb{R}^2 . Furthermore, for any $\psi \in C^1(\mathbb{R}^2)$ with compact support, one has

$$\begin{aligned} \int_{\mathbb{R}^2} (|\nabla \psi|^2 - f'(V)\psi^2) &= \int_{\{x_2 < 0\}} (|\nabla \psi|^2 - f'(U)\psi^2) + \int_{\{x_2 > 0\}} (|\nabla \psi|^2 - f'(V)\psi^2) \\ &= \int_H (|\nabla \psi|^2 - f'(U)\psi^2) + \int_H (|\nabla \tilde{\psi}|^2 - f'(U)\tilde{\psi}^2), \end{aligned}$$

where $\tilde{\psi}(x_1, x_2) = \psi(x_1, -x_2)$. But the restrictions of the functions ψ and $\tilde{\psi}$ in \overline{H} are of class $C^1(\overline{H})$ with compact support in \overline{H} . Therefore, the two terms of the right-hand side of the previous formula are nonnegative by assumption. Hence,

$$\int_{\mathbb{R}^2} (|\nabla \psi|^2 - f'(V)\psi^2) \geq 0$$

for any $\psi \in C^1(\mathbb{R}^2)$ with compact support. Proposition 5.17 implies that V is identically equal to either 0 or 1 in \mathbb{R}^2 , which leads to the desired conclusion for U in \overline{H} . \square

5. Reaction-diffusion fronts in funnel-shaped domains

The last Liouville type result is Proposition 5.5, which was stated in Section 5.1.3. It is concerned with stable axisymmetric solutions in \mathbb{R}^N , and it also follows from Proposition 5.17, as well as from some arguments inspired by [12].

Proof of Proposition 5.5. Throughout the proof, $U : \mathbb{R}^N \rightarrow [0, 1]$ is a stable $C^2(\mathbb{R}^N)$ solution of $\Delta U + f(U) = 0$ in \mathbb{R}^N , which is axisymmetric with respect to the x_1 -axis. Let us first show that

$$\text{either } U(x_1, x') \rightarrow 0 \text{ or } U(x_1, x') \rightarrow 1 \text{ as } |x'| \rightarrow +\infty, \text{ uniformly in } x_1 \in \mathbb{R}. \quad (5.36)$$

To show this property, since U is continuous and axisymmetric with respect to the x_1 -axis, it is sufficient to show that, for any sequence

$$(x^n)_{n \in \mathbb{N}} = ((x_1^n, x_2^n, 0, \dots, 0))_{n \in \mathbb{N}}$$

in \mathbb{R}^N such that $x_2^n \rightarrow +\infty$ as $n \rightarrow +\infty$, one has, up to extraction of a subsequence, either $U(x^n) \rightarrow 0$ or $U(x^n) \rightarrow 1$. Consider any such sequence $(x^n)_{n \in \mathbb{N}}$. Up to extraction of a subsequence, the functions $U(\cdot + x^n)$ converge in $C_{loc}^2(\mathbb{R}^N)$ to a solution U_∞ of $\Delta U_\infty + f(U_\infty) = 0$ in \mathbb{R}^N , with $0 \leq U_\infty \leq 1$ in \mathbb{R}^N . Furthermore, since U is axisymmetric with respect to the x_1 -axis, and $x^n = (x_1^n, x_2^n, 0, \dots, 0)$ with $x_2^n \rightarrow +\infty$, there is a $C^2(\mathbb{R}^2)$ function V_∞ such that $U_\infty(x) = V_\infty(x_1, x_2)$ for all $x \in \mathbb{R}^N$. Notice that V_∞ then obeys $\Delta V_\infty + f(V_\infty) = 0$ in \mathbb{R}^2 . Let us now show that V_∞ is stable, in the sense of (5.18) with $\omega = \mathbb{R}^2$. Consider any $C^1(\mathbb{R}^2)$ function ψ with compact support. For $n \in \mathbb{N}$, let us define

$$\psi_n(x) = \psi(x_1 - x_1^n, |x'| - x_2^n)$$

for $x = (x_1, x') \in \mathbb{R}^N$. Since ψ is compactly supported in \mathbb{R}^2 and since $x_2^n \rightarrow +\infty$ as $n \rightarrow +\infty$, the function ψ_n is of class $C^1(\mathbb{R}^N)$ with compact support for all n large enough. Together with the semistability of the solution U of $\Delta U + f(U) = 0$ in \mathbb{R}^N , one gets that, for all n large enough,

$$\int_{\mathbb{R}^N} |\nabla \psi_n|^2 - f'(U) \psi_n^2 \geq 0.$$

But since both U and ψ_n are axisymmetric with respect to the x_1 -axis, the above inequality means that, for all n large enough,

$$\int_{\mathbb{R}^2} \left[|\nabla \psi(x_1 - x_1^n, x_2 - x_2^n)|^2 - f'(U(x_1, x_2, 0, \dots, 0)) \psi(x_1 - x_1^n, x_2 - x_2^n)^2 \right] dx_1 dx_2 \geq 0,$$

that is,

$$\int_{\mathbb{R}^2} \left[|\nabla \psi(x_1, x_2)|^2 - f'(U(x_1 + x_1^n, x_2 + x_2^n, 0, \dots, 0)) \psi(x_1, x_2)^2 \right] dx_1 dx_2 \geq 0.$$

5.3. Dichotomy between complete propagation and blocking

Since $U(x_1 + x_1^n, x_2 + x_2^n, 0, \dots, 0) \rightarrow U_\infty(x_1, x_2, 0, \dots, 0) = V_\infty(x_1, x_2)$ locally uniformly in $(x_1, x_2) \in \mathbb{R}^2$ as $n \rightarrow +\infty$, since ψ has a compact support, and since f is of class $C^1(\mathbb{R})$, one gets that

$$\int_{\mathbb{R}^2} |\nabla \psi|^2 - f'(V_\infty) \psi^2 \geq 0.$$

As a consequence, the $C^2(\mathbb{R}^2)$ function V_∞ is a stable solution of $\Delta V_\infty + f(V_\infty) = 0$ in \mathbb{R}^2 such that $0 \leq V_\infty \leq 1$ in \mathbb{R}^2 . Proposition 5.17 then implies that either $V_\infty \equiv 0$ in \mathbb{R}^2 , or $V_\infty \equiv 1$ in \mathbb{R}^2 . In particular, either $U(x^n) \rightarrow 0$ or $U(x^n) \rightarrow 1$ as $n \rightarrow +\infty$, at least for a subsequence. But as already emphasized, this is sufficient to infer (5.36).

Let us now show that $|\nabla U(x_1, x')|$ decays to 0 exponentially as $|x'| \rightarrow +\infty$, uniformly in $x_1 \in \mathbb{R}$. To do so, let us consider only the limit 0 in (5.36) (the limit 1 can be handled similarly even if it means changing U into $1 - U$ and $f(s)$ into $-f(1 - s)$). Since $f'(0) < 0 = f(0)$, there is $\delta \in (0, 1)$ such that

$$f(s) \leq \frac{f'(0)}{2} s \quad \text{for all } s \in [0, \delta] \quad (5.37)$$

and there is then $A > 0$ such that

$$0 \leq U(x_1, x') \leq \delta \quad \text{for all } |x'| \geq A \text{ and } x_1 \in \mathbb{R}. \quad (5.38)$$

Take $\gamma > 0$ small enough such that $\gamma^2 + f'(0)/2 < 0$. The function $\bar{U}(x) = \delta e^{-\gamma(|x'|-A)}$ obeys

$$\begin{aligned} \Delta \bar{U}(x) + \frac{f'(0)}{2} \bar{U}(x) &= \delta \left(\gamma^2 - \frac{(N-2)\gamma}{|x'|} \right) e^{-\gamma(|x'|-A)} + \frac{f'(0) \delta e^{-\gamma(|x'|-A)}}{2} \\ &\leq \delta \left(\gamma^2 + \frac{f'(0)}{2} \right) e^{-\gamma(|x'|-A)} < 0 \end{aligned}$$

for all $|x'| \geq A$ and $x_1 \in \mathbb{R}$. Since $U(x_1, x') \leq \delta = \bar{U}(x_1, x')$ for all $|x'| = A$ and $x_1 \in \mathbb{R}$, together with (5.37)–(5.38) and (5.36) with limit 0, it then easily follows from the maximum principle that $U(x_1, x') \leq \bar{U}(x_1, x') = \delta e^{-\gamma(|x'|-A)}$ for all $|x'| \geq A$ and $x_1 \in \mathbb{R}$. From standard elliptic estimates, the function $|\nabla U|$ is bounded in \mathbb{R}^N and moreover there is a positive real number B such that

$$|\nabla U(x)| \leq B e^{-\gamma|x'|} \quad \text{for all } x \in \mathbb{R}^N. \quad (5.39)$$

Now, as in the proof of Proposition 5.17, from the semistability of U , one gets the existence of a positive $C^2(\mathbb{R}^N)$ function φ and of a nonnegative real number λ_∞ such that

$$-\Delta \varphi - f'(U)\varphi = \lambda_\infty \varphi \geq 0 \quad \text{in } \mathbb{R}^N.$$

5. Reaction-diffusion fronts in funnel-shaped domains

Consider any unit vector e of \mathbb{R}^N and denote

$$w = \frac{e \cdot \nabla U}{\varphi}.$$

From standard elliptic estimates and the $C^{1,1}$ smoothness of f , the function U is of class $C^3(\mathbb{R}^N)$ and it is elementary to check that the $C^2(\mathbb{R}^N)$ function w obeys

$$w \nabla \cdot (\varphi^2 \nabla w) = \lambda_\infty \varphi^2 w^2 \geq 0 \quad \text{in } \mathbb{R}^N.$$

Take a $C^\infty(\mathbb{R})$ function ζ such that $0 \leq \zeta \leq 1$ in \mathbb{R} , $\zeta = 1$ in $[-1, 1]$ and $\zeta = 0$ in $\mathbb{R} \setminus (-2, 2)$. For $R \geq 1$ and $x = (x_1, x') \in \mathbb{R}^N$, we define

$$\zeta_R(x) = \zeta\left(\frac{x_1}{R^{N-1}}\right) \times \zeta\left(\frac{|x'|}{R}\right).$$

Each function ζ_R is of class $C^\infty(\mathbb{R}^N)$ with compact support and there is a positive real number C such that, for every $R \geq 1$ and $x = (x_1, x') \in \mathbb{R}^N$, $|\partial_{x_1} \zeta_R(x)| \leq C R^{1-N}$ and $|\nabla \zeta_R(x)| \leq C R^{-1}$. For any $R \geq 1$, let us define

$$\begin{cases} E_R = \{x = (x_1, x') \in \mathbb{R}^N : |x'| \leq R, R^{N-1} \leq |x_1| \leq 2R^{N-1}\}, \\ F_R = \{x = (x_1, x') \in \mathbb{R}^N : R \leq |x'| \leq 2R, |x_1| \leq 2R^{N-1}\}, \\ G_R = E_R \cup F_R. \end{cases}$$

Observe that $|\nabla \zeta_R| = 0$ in $\mathbb{R}^N \setminus G_R$ and that $|\nabla \zeta_R(x)| = |\partial_{x_1} \zeta_R(x)| \leq C R^{1-N}$ for all $x \in E_R$. By integrating the inequation $w \nabla \cdot (\varphi^2 \nabla w) \geq 0$ against ζ_R^2 (notice that all integrals below converge since all involved functions are continuous and ζ_R is compactly supported), one gets that

$$\begin{aligned} \int_{\mathbb{R}^N} \varphi^2 \zeta_R^2 |\nabla w|^2 &\leq -2 \int_{\mathbb{R}^N} w \varphi^2 \zeta_R \nabla \zeta_R \cdot \nabla w = -2 \int_{G_R} w \varphi^2 \zeta_R \nabla \zeta_R \cdot \nabla w \\ &\leq 2 \sqrt{\int_{G_R} \varphi^2 \zeta_R^2 |\nabla w|^2} \sqrt{\int_{G_R} w^2 \varphi^2 |\nabla \zeta_R|^2}. \end{aligned} \tag{5.40}$$

Furthermore, from the above estimates on $\nabla \zeta_R$ and from (5.39), one has

$$\begin{aligned} \int_{G_R} w^2 \varphi^2 |\nabla \zeta_R|^2 &= \int_{E_R} |e \cdot \nabla U|^2 |\nabla \zeta_R|^2 + \int_{F_R} |e \cdot \nabla U|^2 |\nabla \zeta_R|^2 \\ &\leq 2B^2 C^2 \omega_{N-1} + B^2 e^{-2\gamma R} C^2 R^{-2} \omega_{N-1} ((2R)^{N-1} - R^{N-1}) \times (4R^{N-1}), \end{aligned}$$

where ω_{N-1} denotes the $(N-1)$ -dimensional Lebesgue measure of the unit Euclidean ball

5.3. Dichotomy between complete propagation and blocking

in \mathbb{R}^{N-1} . Therefore, there is a positive real number D such that

$$\int_{G_R} w^2 \varphi^2 |\nabla \zeta_R|^2 \leq D \quad (5.41)$$

for all $R \geq 1$, hence

$$\int_{\mathbb{R}^N} \varphi^2 \zeta_R^2 |\nabla w|^2 \leq 4D$$

by (5.40). Therefore, owing to the definition of ζ_R , the integral $\int_{\mathbb{R}^N} \varphi^2 |\nabla w|^2$ converges and

$$\int_{G_R} \varphi^2 \zeta_R^2 |\nabla w|^2 \rightarrow 0 \quad \text{as } R \rightarrow +\infty.$$

Together with (5.40)–(5.41), one infers that

$$\int_{\mathbb{R}^N} \varphi^2 |\nabla w|^2 = 0,$$

hence w is constant in \mathbb{R}^N . Owing to the definition of $w = (e \cdot \nabla U)/\varphi$, this implies that $e \cdot \nabla U$ is either of a strict constant sign, or is identically 0 in \mathbb{R}^N . By taking now $e = (0, e')$ with a unit vector e' of \mathbb{R}^{N-1} , and remembering that $U(x_1, x') \rightarrow 0$ as $|x'| \rightarrow +\infty$, one infers that $e \cdot \nabla U \equiv 0$ in \mathbb{R}^N for any such $e = (0, e')$, and finally $U \equiv 0$ in \mathbb{R}^N . As already underlined, the case of the limit 1 in (5.36) can be handled similarly, and the proof of Proposition 5.5 is thereby complete. \square

5.3.3 Proof of Theorem 5.3

Throughout this section, we consider a domain Ω of the type (5.7)–(5.8), for any $R > 0$ and $\alpha \in [0, \pi/2)$, and we call u the time-increasing solution of (5.1) and (5.9) given in Proposition 5.2. Let $0 < u_\infty \leq 1$ be its $C_{loc}^2(\overline{\Omega})$ limit as $t \rightarrow +\infty$. The function u_∞ solves (5.17), and

$$0 < u(t, x) < u_\infty(x) \leq 1 \quad \text{for all } (t, x) \in \mathbb{R} \times \overline{\Omega}. \quad (5.42)$$

Let us first notice that (5.25) and (5.28) imply that $u(t, x) \rightarrow 1$ as $x_1 \rightarrow -\infty$, at least for every t negative enough. Since u is increasing in t and $u < 1$ in $\mathbb{R} \times \overline{\Omega}$, one infers that, for every $\tau \in \mathbb{R}$,

$$u(t, x) \rightarrow 1 \quad \text{as } x_1 \rightarrow -\infty, \text{ uniformly with respect to } t \geq \tau. \quad (5.43)$$

Together with (5.42), it follows that, if the solution u is blocked in the sense of (5.15), then the convergence of $u(t, \cdot)$ to u_∞ as $t \rightarrow +\infty$ is actually uniform in $\overline{\Omega}$.

After this preliminary observation, the first main step of the proof of Theorem 5.3 consists

5. Reaction-diffusion fronts in funnel-shaped domains

in showing that u_∞ is a stable solution of (5.17) in $\bar{\Omega}$ in the sense of (5.18) with $\omega = \Omega$, whether u_∞ be identically 1 or less than 1 in $\bar{\Omega}$.

Lemma 5.19. *The function u_∞ is a stable solution of (5.17) in $\bar{\Omega}$ in the sense of (5.18).*

Proof. Consider any $C^1(\bar{\Omega})$ function ψ with compact support. The function u satisfies

$$0 \leq u_t = \Delta(u - u_\infty) + f(u) - f(u_\infty) \quad (5.44)$$

in $\mathbb{R} \times \bar{\Omega}$. Since $\nu(x) \cdot \nabla(u(t, x) - u_\infty(x)) = 0$ for all $(t, x) \in \mathbb{R} \times \partial\Omega$ and since ψ has compact support, multiplying (5.44) by the nonnegative function $\psi^2/(u_\infty - u(t, \cdot))$ and integrating by parts over $\bar{\Omega}$, at a fixed time $t \in \mathbb{R}$, leads to

$$\begin{aligned} 0 &\leq \int_{\bar{\Omega}} \nabla(u_\infty - u(t, \cdot)) \cdot \nabla \left(\frac{\psi^2}{u_\infty - u(t, \cdot)} \right) - \frac{f(u(t, \cdot)) - f(u_\infty)}{u(t, \cdot) - u_\infty} \psi^2 \\ &= \int_{\bar{\Omega}} 2 \frac{\psi \nabla(u_\infty - u(t, \cdot)) \cdot \nabla \psi}{u_\infty - u(t, \cdot)} - \frac{|\nabla(u_\infty - u(t, \cdot))|^2 \psi^2}{(u_\infty - u(t, \cdot))^2} - \frac{f(u(t, \cdot)) - f(u_\infty)}{u(t, \cdot) - u_\infty} \psi^2 \\ &\leq \int_{\bar{\Omega}} |\nabla \psi|^2 - \frac{f(u(t, \cdot)) - f(u_\infty)}{u(t, \cdot) - u_\infty} \psi^2, \end{aligned}$$

where all the above integrals converge since ψ has compact support and all integrated functions or fields are at least continuous in $\bar{\Omega}$. But since ψ has compact support and $u(t, \cdot) \rightarrow u_\infty$ as $t \rightarrow +\infty$ at least locally uniformly in $\bar{\Omega}$, the passage to the limit as $t \rightarrow +\infty$ in the above formula yields

$$0 \leq \int_{\bar{\Omega}} |\nabla \psi|^2 - f'(u_\infty) \psi^2.$$

From the arbitrariness of $\psi \in C^1(\bar{\Omega})$ with compact support, the proof is complete. \square

Proof of Theorem 5.3. In order to show that u either propagates completely in the sense of (5.16) or is blocked in the sense of (5.15), we have to show that either $u_\infty \equiv 1$ in $\bar{\Omega}$, or $u_\infty(x) \rightarrow 0$ as $x_1 \rightarrow +\infty$. Since the case $\alpha = 0$ is trivial, as already noticed in the introduction ($u_\infty \equiv 1$ in $\bar{\Omega}$ in this case), one can assume that

$$\alpha > 0$$

in the sequel. From Lemma 5.15, it is then sufficient to show that either $u_\infty(x) \rightarrow 1$ as $x_1 \rightarrow +\infty$ or $u_\infty(x) \rightarrow 0$ as $x_1 \rightarrow +\infty$. Since, for each $B \in \mathbb{R}$, the set $\{x \in \bar{\Omega} : x_1 \geq B\}$ is connected and since u_∞ is continuous in $\bar{\Omega}$, it is sufficient to show that, for any sequence $(x^n)_{n \in \mathbb{N}}$ with

$$x_1^n \rightarrow +\infty \quad \text{as } n \rightarrow +\infty,$$

up to extraction of a subsequence, either $u_\infty(x^n) \rightarrow 0$ or $u_\infty(x^n) \rightarrow 1$ as $n \rightarrow +\infty$. Consider such a sequence $(x^n)_{n \in \mathbb{N}}$ in the sequel. Since the functions u and u_∞ are axisymmetric with

5.3. Dichotomy between complete propagation and blocking

respect to the x_1 -axis, one can assume without loss of generality that

$$x^n = (x_1^n, x_2^n, 0, \dots, 0), \quad \text{with } 0 \leq x_2^n \leq h(x_1^n),$$

for each $n \in \mathbb{N}$. Up to extraction of a subsequence, three cases can occur: either $\sup_{n \in \mathbb{N}} x_2^n < +\infty$, or $x_2^n \rightarrow +\infty$ and $h(x_1^n) - x_2^n \rightarrow +\infty$ as $n \rightarrow +\infty$, or $\sup_{n \in \mathbb{N}} (h(x_1^n) - x_2^n) < +\infty$. We consider these three cases separately.

Let us firstly consider the case $\sup_{n \in \mathbb{N}} x_2^n < +\infty$. Call

$$y^n = (x_1^n, 0, \dots, 0).$$

Here, up to extraction of a subsequence, the functions $u_\infty(\cdot + y^n)$ converge in $C_{loc}^2(\mathbb{R}^N)$ to a $C^2(\mathbb{R}^N)$ solution U of $\Delta U + f(U) = 0$ in \mathbb{R}^N which is axisymmetric with respect to the x_1 -axis (since so is u_∞). Furthermore, $0 \leq U \leq 1$ in \mathbb{R}^N . Let us now show that U is stable in the sense of (5.18) (Proposition 5.5 will then yield the desired conclusion). Pick any $C^1(\mathbb{R}^N)$ function ψ with compact support K . For $n \in \mathbb{N}$, denote $\psi_n(x) = \psi(x - y^n)$ for $x \in \bar{\Omega}$. Each function ψ_n is of class $C^1(\bar{\Omega})$ with compact support, hence

$$\int_{\bar{\Omega}} |\nabla \psi_n|^2 - f'(u_\infty) \psi_n^2 \geq 0$$

by the semistability of u_∞ established in Lemma 5.19. But, for every n large enough, the support $y^n + K$ of ψ_n is included in $\bar{\Omega}$, and the previous inequality then means that

$$\int_K |\nabla \psi|^2 - f'(u_\infty(\cdot + y^n)) \psi^2 \geq 0.$$

Since $u_\infty(\cdot + y^n) \rightarrow U$ as $n \rightarrow +\infty$ at least locally uniformly in \mathbb{R}^N and f is of class $C^1(\mathbb{R})$, one concludes by passing to the limit $n \rightarrow +\infty$

$$\int_{\mathbb{R}^N} |\nabla \psi|^2 - f'(U) \psi^2 = \int_K |\nabla \psi|^2 - f'(U) \psi^2 \geq 0.$$

Therefore, U is a stable solution of $\Delta U + f(U) = 0$ in \mathbb{R}^N and it satisfies the other assumptions of Proposition 5.5. One then deduces that either $U \equiv 0$ in \mathbb{R}^N or $U \equiv 1$ in \mathbb{R}^N . In particular, since the sequence $(x_2^n)_{n \in \mathbb{N}}$ was assumed to be bounded, one concludes that either $u_\infty(x^n) \rightarrow 0$ or $u_\infty(x^n) \rightarrow 1$, up to extraction of a subsequence.

In the second case, we assume that $x_2^n \rightarrow +\infty$ and $h(x_1^n) - x_2^n \rightarrow +\infty$ as $n \rightarrow +\infty$. Define $U_n(x) = u_\infty(x + x^n)$ for $x \in \bar{\Omega} - x^n$. From standard elliptic estimates, together with the axisymmetry of u_∞ with respect to the x_1 -axis, the functions U_n converge in $C_{loc}^2(\mathbb{R}^N)$, up to extraction of a subsequence, to a $C^2(\mathbb{R}^N)$ function \tilde{U} , which actually depends on (x_1, x_2)

5. Reaction-diffusion fronts in funnel-shaped domains

only, that is,

$$\tilde{U}(x_1, \dots, x_N) = U(x_1, x_2)$$

for some $C^2(\mathbb{R}^2)$ function U , and there holds $\Delta U + f(U) = 0$ in \mathbb{R}^2 . Furthermore, $0 \leq U \leq 1$ in \mathbb{R}^2 . Let us now show that U satisfies the condition (5.18) with $\omega = \mathbb{R}^2$, and Proposition 5.17 will then yield the desired conclusion. So, consider any $C^1(\mathbb{R}^2)$ function ψ with compact support K . For $n \in \mathbb{N}$, define the following function ψ_n in $\bar{\Omega}$ by:

$$\psi_n(x) = \psi_n(x_1, x') = \begin{cases} \psi(x_1 - x_1^n, |x'| - x_2^n) & \text{if } (x_1, |x'|) \in K + (x_1^n, x_2^n), \\ 0 & \text{otherwise.} \end{cases}$$

Since $\lim_{n \rightarrow +\infty} x_2^n = +\infty$, it follows that, for every n large enough, ψ_n is a $C^1(\bar{\Omega})$ function with compact support. Lemma 5.19 implies that, for all n large enough,

$$\int_{\bar{\Omega}} |\nabla \psi_n|^2 - f'(u_\infty) \psi_n^2 \geq 0.$$

But since both u_∞ and ψ_n are axisymmetric with respect to the x_1 -axis, the above inequality means that, for all n large enough,

$$\int_{\{x_1 \in \mathbb{R}, 0 \leq x_2 \leq h(x_1)\}} \left[|\nabla \psi(x_1 - x_1^n, x_2 - x_2^n)|^2 - f'(u_\infty(x_1, x_2, 0, \dots, 0)) \psi(x_1 - x_1^n, x_2 - x_2^n)^2 \right] dx_1 dx_2 \geq 0. \quad (5.45)$$

Since both sequences $(x_2^n)_{n \in \mathbb{N}}$ and $(h(x_1^n) - x_2^n)_{n \in \mathbb{N}}$ converge to $+\infty$ and since ψ has compact support, denoted by K , the previous inequality means that, for all n large enough,

$$\int_K \left[|\nabla \psi(x_1, x_2)|^2 - f'(u_\infty(x_1 + x_1^n, x_2 + x_2^n, 0, \dots, 0)) \psi(x_1, x_2)^2 \right] dx_1 dx_2 \geq 0. \quad (5.46)$$

Since $u_\infty(x_1 + x_1^n, x_2 + x_2^n, 0, \dots, 0) \rightarrow \tilde{U}(x_1, x_2, 0, \dots, 0) = U(x_1, x_2)$ locally uniformly in $(x_1, x_2) \in \mathbb{R}^2$ as $n \rightarrow +\infty$, and since f is of class $C^1(\mathbb{R})$, one gets that

$$\int_{\mathbb{R}^2} |\nabla \psi|^2 - f'(U) \psi^2 \geq 0.$$

As a consequence, the $C^2(\mathbb{R}^2)$ function U is a stable solution of $\Delta U + f(U) = 0$ in \mathbb{R}^2 such that $0 \leq U \leq 1$ in \mathbb{R}^2 . Proposition 5.17 then implies that either $U \equiv 0$ in \mathbb{R}^2 or $U \equiv 1$ in \mathbb{R}^2 , that is, either $\tilde{U} \equiv 0$ or $\tilde{U} \equiv 1$ in \mathbb{R}^N . Hence, either $u_\infty(x^n) \rightarrow 0$ or $u_\infty(x^n) \rightarrow 1$, up to extraction of a subsequence.

5.3. Dichotomy between complete propagation and blocking

Consider thirdly the case $\sup_{n \in \mathbb{N}} h(x_1^n) - x_2^n < +\infty$. Define

$$y^n = (x_1^n, h(x_1^n), 0, \dots, 0), \quad U_n(x) = u_\infty(x + y^n) \text{ for } x \in \bar{\Omega} - y^n,$$

and

$$H = \{(x_1, x_2) \in \mathbb{R}^2 : x_2 < x_1 \tan \alpha\},$$

which is an open half-plane of \mathbb{R}^2 . From standard elliptic estimates, together with the definitions (5.7)–(5.8) and the axisymmetry of u_∞ with respect to the x_1 -axis, there is a $C^2(\bar{H} \times \mathbb{R}^{N-2})$ function \tilde{U} , which actually depends on (x_1, x_2) only, that is,

$$\tilde{U}(x_1, \dots, x_N) = U(x_1, x_2)$$

for some $U \in C^2(\bar{H})$, such that, up to extraction of a subsequence, $\|U_n - \tilde{U}\|_{C^2(\mathcal{K} \cap (\bar{\Omega} - y^n))} \rightarrow 0$ as $n \rightarrow +\infty$ for every compact set $\mathcal{K} \subset \mathbb{R}^N$ (notice that, for each such \mathcal{K} , there holds $\mathcal{K} \cap (\bar{\Omega} - y^n) \subset \bar{H} \times \mathbb{R}^{N-2}$ for all n large enough). The function U then satisfies

$$\Delta U + f(U) = 0 \text{ in } \bar{H},$$

together with $\nu \cdot \nabla U = 0$ on ∂H and $0 \leq U \leq 1$ in \bar{H} . Let us now show that U satisfies the condition (5.18) with $\omega = H$, and Proposition 5.18 will then yield the desired conclusion. So, consider any $C^1(\bar{H})$ function ψ with compact support K . For $n \in \mathbb{N}$, define the following function ψ_n in $\bar{\Omega}$ by:

$$\psi_n(x) = \psi_n(x_1, x') = \begin{cases} \psi(x_1 - x_1^n, |x'| - h(x_1^n)) & \text{if } (x_1, |x'|) \in K + (x_1^n, h(x_1^n)), \\ 0 & \text{otherwise.} \end{cases}$$

Since $\lim_{n \rightarrow +\infty} h(x_1^n) = +\infty$, it follows that, for all n large enough, ψ_n is a $C^1(\bar{\Omega})$ function with compact support. Lemma 5.19 implies that, for all n large enough,

$$\int_{\bar{\Omega}} |\nabla \psi_n|^2 - f'(u_\infty) \psi_n^2 \geq 0.$$

But since both u_∞ and ψ_n are axisymmetric with respect to the x_1 -axis, and since $h(x_1) = x_1 \tan \alpha$ for all $x_1 \geq L \cos \alpha$, together with $x_1^n \rightarrow +\infty$ as $n \rightarrow +\infty$, the definition of ψ_n and the previous inequality then yield (5.45)–(5.46), with x_2^n replaced by $h(x_1^n)$, for all n large enough. Since $u_\infty(x_1 + x_1^n, x_2 + h(x_1^n), 0, \dots, 0) \rightarrow \tilde{U}(x_1, x_2, 0, \dots, 0) = U(x_1, x_2)$ uniformly in K (because $K \times \{0\}^{N-2} \subset \bar{\Omega} - y^n$ for all n large enough), and since f is of class $C^1(\mathbb{R})$, one gets that

$$\int_{\bar{H}} |\nabla \psi|^2 - f'(U) \psi^2 \geq 0.$$

5. Reaction-diffusion fronts in funnel-shaped domains

As a consequence, the $C^2(\overline{H})$ function U is a stable solution of $\Delta U + f(U) = 0$ in \overline{H} such that $0 \leq U \leq 1$ in \overline{H} . Proposition 5.18 then implies that either $U \equiv 0$ in \overline{H} or $U \equiv 1$ in \overline{H} , that is, either $\tilde{U} \equiv 0$ or $\tilde{U} \equiv 1$ in $\overline{H} \times \mathbb{R}^{N-2}$. Hence, either $u_\infty(x^n) \rightarrow 0$ or $u_\infty(x^n) \rightarrow 1$, up to extraction of a subsequence.

As a conclusion, for any sequence $(x^n)_{n \in \mathbb{N}}$ in $\overline{\Omega}$ such that $x_1^n \rightarrow +\infty$ as $n \rightarrow +\infty$, one has, up to extraction of a subsequence, either $u_\infty(x^n) \rightarrow 0$ or $u_\infty(x^n) \rightarrow 1$ as $n \rightarrow +\infty$. As already emphasized, this leads to the desired conclusion, and the proof of Theorem 5.3 is thereby complete. \square

5.4 Transition fronts and long-time behavior of the level sets

This section is devoted to the proofs of Theorems 5.6 and 5.7. For any given $R > 0$ and $\alpha \in [0, \pi/2)$, we especially show that the solution $0 < u < 1$ of (5.1) emanating from the planar front $\phi(x_1 - ct)$ in the sense of (5.9) is a transition front connecting 1 and 0, and we show further more precise estimates on the position of the level sets at large time in case of complete propagation. But we start in the next subsection with the, immediate, proof of Theorem 5.7.

5.4.1 Proof of Theorem 5.7

We here assume that u is blocked, in the sense of (5.15). Since $u(t, x) - \phi(x_1 - ct) \rightarrow 0$ as $t \rightarrow -\infty$ uniformly in $x \in \overline{\Omega}$, and since $\phi(-\infty) = 1$ and $\phi(+\infty) = 0$, one infers that

$$\sup_{t \leq -A, x \in \overline{\Omega}, x_1 - ct \leq -A} |u(t, x) - 1| \rightarrow 0 \quad \text{and} \quad \sup_{t \leq -A, x \in \overline{\Omega}, x_1 - ct \geq A} u(t, x) \rightarrow 0 \quad \text{as } A \rightarrow +\infty.$$

Furthermore, from (5.43), one knows that, for every $\tau \in \mathbb{R}$, $u(t, x) \rightarrow 1$ as $x_1 \rightarrow -\infty$, uniformly with respect to $t \geq \tau$. Since $0 < u(t, x) < u_\infty(x)$ for all $(t, x) \in \mathbb{R} \times \overline{\Omega}$ and $u_\infty(x) \rightarrow 0$ as $x_1 \rightarrow +\infty$, there also holds

$$u(t, x) \rightarrow 0 \quad \text{as } x_1 \rightarrow +\infty, \quad \text{uniformly in } t \geq \tau,$$

for every $\tau \in \mathbb{R}$. All these properties, owing to the definition (5.7)–(5.8) of Ω , imply that u is a transition front connecting 1 and 0, with the sets Ω_t^\pm and Γ_t given for instance by (5.24). In particular, u does not have any global mean speed in the sense of Definition 5.1 (but one can still say that it has a “past” speed equal to c , and a “future” speed equal to 0, following the terminology used in [99]).

5.4.2 Proof of Theorem 5.6

We here assume that $\alpha > 0$ and the solution u of (5.1) with past condition (5.9) propagates completely, namely $u(t, \cdot) \rightarrow 1$ as $t \rightarrow +\infty$ locally uniformly in $\bar{\Omega}$. We will prove, thanks to a comparison argument, that the level sets of u can be sandwiched between two expanding spherical surfaces at large time in $\bar{\Omega}^+$, and that u is a transition front with sets Γ_t and Ω_t^\pm defined by (5.20)–(5.21). Moreover, we show that along each level set the function u converges locally to the planar traveling front at large time, in which a Liouville type theorem of Berestycki and the first author in [18] for entire solutions of the bistable equation plays an essential role.

Large time estimates of u for $x \in \bar{\Omega}^+$ with $|x|$ large

We aim at proving the key Lemma 5.20 below, which gives refined bounds, for large t and for $x \in \bar{\Omega}^+$ with large norm $|x|$, of the solution u of (5.1) satisfying the complete propagation condition (5.16). This lemma is based on the construction, inspired by Fife and McLeod [76] and Uchiyama [154], of suitable sub- and supersolutions. For this purpose, let us first define a function ϑ in $[0, +\infty)$ by

$$\vartheta(t) = \frac{2(\ln(t+1))^{3/2}}{3}.$$

Notice that

$$\vartheta(t) \geq 0 \quad \text{and} \quad 0 \leq \vartheta'(t) = \frac{\sqrt{\ln(t+1)}}{t+1} < 1 \quad \text{for all } t \geq 0, \quad (5.47)$$

and

$$\int_0^{+\infty} e^{-r\vartheta(t)} dt < +\infty \quad \text{for all } r > 0.$$

We also recall that $L > 0$ is given in (5.8).

Lemma 5.20. *There exist $\tau > 0$, $\tau_1 \in \mathbb{R}$, $\tau_2 \in \mathbb{R}$, $z_1 \in \mathbb{R}$, $z_2 \in \mathbb{R}$, $\delta > 0$ and $\mu > 0$ such that*

$$\begin{aligned} u(t, x) &\leq \phi\left(|x| - c(t - \tau_1 + \tau) + \frac{N-1}{c} \ln(t - \tau_1 + \tau) + z_1\right) + \delta e^{-\delta\vartheta(t-\tau_1)} + \delta e^{-\mu(|x|-L)} \\ &\quad \text{for all } t \geq \tau_1 \text{ and } x \in \bar{\Omega}^+ \text{ with } |x| \geq L, \end{aligned} \quad (5.48)$$

and

$$\begin{aligned} u(t, x) &\geq \phi\left(|x| - c(t - \tau_2 + \tau) + \frac{N-1}{c} \ln(t - \tau_2 + \tau) + z_2\right) - \delta e^{-\delta\vartheta(t-\tau_2)} - \delta e^{-\mu(|x|-L)} \\ &\quad \text{for all } t \geq \tau_2 \text{ and } x \in \bar{\Omega}^+ \text{ with } |x| \geq L. \end{aligned} \quad (5.49)$$

Proof. Step 1: choice of some parameters. Choose first $\mu > 0$ and then $\delta \in (0, 1/2)$ such

5. Reaction-diffusion fronts in funnel-shaped domains

that

$$0 < \mu < \sqrt{\min\left(\frac{|f'(0)|}{2}, \frac{|f'(1)|}{2}\right)}, \quad (5.50)$$

and

$$0 < \delta < \min\left(\frac{\mu c}{2}, \frac{\mu_*}{2}, \frac{\mu^*}{2}, \frac{\mu^2}{2}\right), \quad f' \leq \frac{f'(0)}{2} \text{ in } [0, 3\delta], \quad f' \leq \frac{f'(1)}{2} \text{ in } [1 - 3\delta, 1], \quad (5.51)$$

with $\mu_* > 0$ and $\mu^* > 0$ as in (5.5). From (5.4)–(5.6), there are $C > 0$ and $K > 0$ such that

$$\phi \geq 1 - \delta \text{ in } (-\infty, -C], \quad \phi \leq \delta \text{ in } [C, +\infty), \quad |\phi'(z)| \leq K \min(e^{\mu_* z/2}, e^{-\mu^* z/2}) \text{ for all } z \in \mathbb{R}. \quad (5.52)$$

Since ϕ' is continuous and negative in \mathbb{R} , there exists a constant $\kappa > 0$ such that

$$\phi' \leq -\kappa \text{ in } [-C, C]. \quad (5.53)$$

We then choose $\sigma > 0$ such that

$$\max_{[0,1]} |f'| + \mu^2 \leq \kappa \sigma. \quad (5.54)$$

Let then $\tau_0 > 0$ be such that

$$\frac{N-1}{c} \ln t \leq \frac{c}{2} t \text{ for all } t \geq \tau_0, \quad (5.55)$$

and $\eta > 0$ such that

$$e^{-\mu_* \eta/2} \leq \frac{L}{c\tau_0}. \quad (5.56)$$

From (5.51), there exist some constants $M_1, M_2 \geq C$ such that

$$\max\left(\frac{(N-1)K e^{-\mu_*(M_1+\vartheta(t))/2}}{c\tau_0}, \frac{(N-1)K e^{-\mu^*(M_2+\vartheta(t))/2}}{L}\right) \leq \delta^2 e^{-\delta\vartheta(t)} \text{ for all } t \geq 0 \quad (5.57)$$

Now define

$$\omega = \int_0^{+\infty} \sigma \delta (e^{-\delta\vartheta(s)} + e^{-\delta s}) ds \in (0, +\infty),$$

and

$$M = \max(M_1 + \omega + 1 + \eta, M_2 + \omega + 1) > 0 \quad \text{and} \quad B = 2C + \omega + 1 > 0.$$

For every $\tau \geq \tau_0$, (5.55) implies that $c(t+\tau) - ((N-1)/c) \ln(t+\tau) + L + B - C + M + \vartheta(t) \geq L$

for all $t \geq 0$, hence the function Λ defined in $[0, +\infty)$ by

$$\Lambda(t) = \sup_{\substack{|x| - c(t+\tau) + ((N-1)/c) \ln(t+\tau) - L - B + C \leq M + \vartheta(t) \\ x \in \overline{\Omega^+}, |x| \geq L}} \left| \frac{N-1}{|x|} - \frac{N-1}{c(t+\tau)} \right| \geq 0 \quad (5.58)$$

is well defined, nonnegative and continuous in $[0, +\infty)$. Furthermore, it is easy to see that it is integrable over $[0, +\infty)$, and that

$$\lim_{\tau \rightarrow +\infty} \int_0^{+\infty} \Lambda(t) dt = 0.$$

Let us then fix $\tau \geq \max(\tau_0, L/c)$ large enough so that $\int_0^{+\infty} \Lambda(t) dt < 1$ and let us introduce a nonnegative function ϱ defined in $[0, +\infty)$ by

$$\varrho(t) = \int_0^t (\Lambda(s) + \sigma \delta (e^{-\delta \vartheta(s)} + e^{-\delta s})) ds \geq 0. \quad (5.59)$$

One then has $0 < \varrho(+\infty) < 1 + \omega$. Hence,

$$M \geq \max(M_1 + \varrho(+\infty) + \eta, M_2 + \varrho(+\infty)) \geq C + \varrho(+\infty) \quad \text{and} \quad B \geq 2C + \varrho(+\infty)$$

and, from (5.56)–(5.57) and the inequality $c\tau \geq L$, there holds

$$\max\left(\frac{(N-1)K e^{-\mu_*(M+\vartheta(t)-\varrho(+\infty))/2}}{L}, \frac{(N-1)K e^{-\mu^*(M+\vartheta(t)-\varrho(+\infty))/2}}{c\tau}\right) \leq \delta^2 e^{-\delta \vartheta(t)} \quad \text{for all } t \geq 0. \quad (5.60)$$

For notational convenience, let us finally define, for $s \geq 0$ and $x \in \overline{\Omega^+}$ with $|x| \geq L$,

$$A(s, x) = \frac{N-1}{|x|} - \frac{N-1}{c(s+\tau)}$$

and

$$\zeta(s, x) = |x| - c(s+\tau) + \frac{N-1}{c} \ln(s+\tau) - L - B + C.$$

Step 2: proof of (5.48). Since $u(t, x) - \phi(x_1 - ct) \rightarrow 0$ as $t \rightarrow -\infty$ uniformly in $\overline{\Omega}$, and since $\phi(+\infty) = 0$, there exists $\tau_1 < 0$ such that $\phi(-c\tau_1) \leq \delta/2$ and

$$u(\tau_1, x) \leq \phi(x_1 - c\tau_1) + \frac{\delta}{2} \leq \phi(-c\tau_1) + \frac{\delta}{2} \leq \delta \quad (5.61)$$

5. Reaction-diffusion fronts in funnel-shaped domains

for all $x \in \overline{\Omega^+}$. For $t \geq \tau_1$ and $x \in \overline{\Omega^+}$ with $|x| \geq L$, let us set

$$\bar{u}(t, x) = \min \left(\phi(\bar{\xi}(t, x)) + \delta e^{-\delta\vartheta(t-\tau_1)} + \delta e^{-\mu(|x|-L)}, 1 \right),$$

where

$$\bar{\xi}(t, x) = \zeta(t - \tau_1, x) - \varrho(t - \tau_1) = |x| - c(t - \tau_1 + \tau) + \frac{N-1}{c} \ln(t - \tau_1 + \tau) - L - B + C - \varrho(t - \tau_1).$$

Let us now check that $\bar{u}(t, x)$ is a supersolution of the problem satisfied by $u(t, x)$ for $t \geq \tau_1$ and $x \in \overline{\Omega^+}$ with $|x| \geq L$.

We first verify the initial and boundary conditions. On the one hand, at time $t = \tau_1$, from (5.61) it follows that $\bar{u}(\tau_1, x) \geq \delta \geq u(\tau_1, x)$ for all $x \in \overline{\Omega^+}$ with $|x| \geq L$. On the other hand, for $t \geq \tau_1$ and for all $x \in \overline{\Omega^+}$ with $|x| = L$, one infers from (5.55), (5.59) and the choice of $B = 2C + \omega + 1 \geq 2C$, that $\bar{\xi}(t, x) \leq -B + C \leq -C$, hence (5.52) gives $\phi(\bar{\xi}(t, x)) \geq 1 - \delta$, which yields $\bar{u}(t, x) \geq \min(1 - \delta + \delta e^{-\delta\vartheta(t-\tau_1)} + \delta, 1) = 1 > u(t, x)$. Lastly, owing to (5.7)–(5.8), one has $\nu(x) \cdot \nabla \bar{u}(t, x) = 0$ for every $t \geq \tau_1$ and $x \in \partial\Omega^+$ such that $|x| > L$ and $\bar{u}(t, x) < 1$, since $\nu(x) \cdot x/|x| = 0$ at any such x .

Next, let us check that

$$\mathcal{L}\bar{u}(t, x) = \bar{u}_t(t, x) - \Delta \bar{u}(t, x) - f(\bar{u}(t, x)) \geq 0$$

for all $t \geq \tau_1$ and $x \in \overline{\Omega^+}$ such that $|x| \geq L$ and $\bar{u}(t, x) < 1$. After a straightforward computation, we get, for such a (t, x) ,

$$\begin{aligned} \mathcal{L}\bar{u}(t, x) &= f(\phi(\bar{\xi}(t, x))) - f(\bar{u}(t, x)) - \delta^2 \vartheta'(t - \tau_1) e^{-\delta\vartheta(t-\tau_1)} - \mu^2 \delta e^{-\mu(|x|-L)} \\ &\quad + \frac{N-1}{|x|} \mu \delta e^{-\mu(|x|-L)} - \left(\varrho'(t - \tau_1) + \underbrace{\frac{N-1}{|x|} - \frac{N-1}{c(t - \tau_1 + \tau)}}_{=A(t-\tau_1, x) \geq -\frac{N-1}{c\tau} \geq -\frac{N-1}{c\tau_0}} \right) \phi'(\bar{\xi}(t, x)). \end{aligned}$$

Three cases can occur, namely: either $\zeta(t - \tau_1, x) < -M - \vartheta(t - \tau_1)$, or $\zeta(t - \tau_1, x) > M + \vartheta(t - \tau_1)$, or $|\zeta(t - \tau_1, x)| \leq M + \vartheta(t - \tau_1)$.

Consider firstly the case

$$\zeta(t - \tau_1, x) < -M - \vartheta(t - \tau_1).$$

One then has $\bar{\xi}(t, x) \leq \zeta(t - \tau_1, x) < -M - \vartheta(t - \tau_1) < -M_1 - \vartheta(t - \tau_1) \leq -C$, hence $1 > \phi(\bar{\xi}(t, x)) \geq 1 - \delta$ and $\bar{u}(t, x) \geq 1 - \delta$ (remember also that (t, x) is assumed to be such that $1 > \bar{u}(t, x)$). By (5.51) one gets that

$$f(\phi(\bar{\xi}(t, x))) - f(\bar{u}(t, x)) \geq -\frac{f'(1)}{2} (\delta e^{-\delta\vartheta(t-\tau_1)} + \delta e^{-\mu(|x|-L)}).$$

Notice also from (5.52) that $0 < -\phi'(\bar{\xi}(t, x)) \leq Ke^{\mu^*\bar{\xi}(t, x)/2} \leq Ke^{\mu^*(-M_1 - \vartheta(t - \tau_1))/2}$, which yields

$$-A(t - \tau_1, x) \phi'(\bar{\xi}(t, x)) \geq -\frac{N-1}{c\tau_0} Ke^{\mu^*(-M_1 - \vartheta(t - \tau_1))/2} \geq -\delta^2 e^{-\delta\vartheta(t - \tau_1)}$$

thanks to (5.57). Hence, it follows from (5.47), (5.50)–(5.51), (5.59), as well as the negativity of ϕ' and $f'(1)$, that

$$\begin{aligned} \mathcal{L}\bar{u}(t, x) &\geq -\frac{f'(1)}{2}(\delta e^{-\delta\vartheta(t - \tau_1)} + \delta e^{-\mu(|x| - L)}) - \delta^2 \vartheta'(t - \tau_1) e^{-\delta\vartheta(t - \tau_1)} - \mu^2 \delta e^{-\mu(|x| - L)} \\ &\quad + \frac{N-1}{|x|} \mu \delta e^{-\mu(|x| - L)} - \varrho'(t - \tau_1) \phi'(\bar{\xi}(t, x)) - \delta^2 e^{-\delta\vartheta(t - \tau_1)} \\ &\geq \left(-\frac{f'(1)}{2} - \delta \vartheta'(t - \tau_1) - \delta\right) \delta e^{-\delta\vartheta(t - \tau_1)} + \left(-\frac{f'(1)}{2} - \mu^2\right) \delta e^{-\mu(|x| - L)} \geq 0. \end{aligned}$$

Consider secondly the case

$$\zeta(t - \tau_1, x) > M + \vartheta(t - \tau_1).$$

One then has $\bar{\xi}(t, x) > M + \vartheta(t - \tau_1) - \varrho(+\infty) \geq C$, hence $0 < \phi(\bar{\xi}(t, x)) \leq \delta$ and $0 < \bar{u}(t, x) \leq 3\delta$. From (5.51) one gets that $f(\phi(\bar{\xi}(t, x))) - f(\bar{u}(t, x)) \geq -(f'(0)/2)(\delta e^{-\delta\vartheta(t - \tau_1)} + \delta e^{-\mu(|x| - L)})$. By noticing that $0 < -\phi'(\bar{\xi}(t, x)) \leq Ke^{-\mu^*\bar{\xi}(t, x)/2} \leq Ke^{-\mu^*(M + \vartheta(t - \tau_1) - \varrho(+\infty))/2}$ from (5.52), one gets that

$$-A(t - \tau_1) \phi'(\bar{\xi}(t, x)) \geq -\frac{N-1}{c\tau} Ke^{-\mu^*(M + \vartheta(t - \tau_1) - \varrho(+\infty))/2} \geq -\delta^2 e^{-\delta\vartheta(t - \tau_1)},$$

from (5.60). It then follows from (5.47), (5.50)–(5.51), (5.59), as well as the negativity of ϕ' and $f'(0)$, that

$$\begin{aligned} \mathcal{L}\bar{u}(t, x) &\geq -\frac{f'(0)}{2}(\delta e^{-\delta\vartheta(t - \tau_1)} + \delta e^{-\mu(|x| - L)}) - \delta^2 \vartheta'(t - \tau_1) e^{-\delta\vartheta(t - \tau_1)} - \mu^2 \delta e^{-\mu(|x| - L)} \\ &\quad + \frac{N-1}{|x|} \mu \delta e^{-\mu(|x| - L)} - \varrho'(t - \tau_1) \phi'(\bar{\xi}(t, x)) - \delta^2 e^{-\delta\vartheta(t - \tau_1)} \\ &\geq \left(-\frac{f'(0)}{2} - \delta \vartheta'(t - \tau_1) - \delta\right) \delta e^{-\delta\vartheta(t - \tau_1)} + \left(-\frac{f'(0)}{2} - \mu^2\right) \delta e^{-\mu(|x| - L)} \geq 0. \end{aligned}$$

Lastly, we consider the case

$$|\zeta(t - \tau_1, x)| \leq M + \vartheta(t - \tau_1).$$

One observes from the definitions of Λ and ϱ in (5.58)–(5.59) that, in this range, there holds

$$\varrho'(t - \tau_1) + A(t - \tau_1, x) \geq \sigma \delta (e^{-\delta\vartheta(t - \tau_1)} + e^{-\delta(t - \tau_1)}) > 0. \quad (5.62)$$

5. Reaction-diffusion fronts in funnel-shaped domains

Three subcases may then occur. If $-C \leq \bar{\xi}(t, x) \leq C$, then $-\phi'(\bar{\xi}(t, x)) \geq \kappa > 0$ by (5.53) and $f(\phi(\bar{\xi}(t, x))) - f(\bar{u}(t, x)) \geq -(\max_{[0,1]} |f'|)(\delta e^{-\delta\vartheta(t-\tau_1)} + \delta e^{-\mu(|x|-L)})$. Moreover, from the expression of $\bar{\xi}(t, x)$ and (5.55), one obtains

$$|x|-L \geq c(t-\tau_1+\tau) - \frac{N-1}{c} \ln(t-\tau_1+\tau) + B - 2C \geq \frac{c}{2}(t-\tau_1+\tau) + B - 2C > \frac{c}{2}(t-\tau_1) + B - 2C.$$

This reveals that $e^{-\mu(|x|-L)} \leq e^{-\mu(c(t-\tau_1)/2+B-2C)}$. Therefore, since $B > 2C$, and by virtue of (5.47), (5.51), (5.53)–(5.54) and (5.62), one gets that

$$\begin{aligned} \mathcal{L}\bar{u}(t, x) &\geq - \left(\max_{[0,1]} |f'| \right) (\delta e^{-\delta\vartheta(t-\tau_1)} + \delta e^{-\mu(|x|-L)}) - \delta^2 \vartheta'(t-\tau_1) e^{-\delta\vartheta(t-\tau_1)} - \mu^2 \delta e^{-\mu(|x|-L)} \\ &\quad + \frac{N-1}{|x|} \mu \delta e^{-\mu(|x|-L)} + \kappa \sigma \delta (e^{-\delta\vartheta(t-\tau_1)} + e^{-\delta(t-\tau_1)}) \\ &\geq \left(- \max_{[0,1]} |f'| - \delta \vartheta'(t-\tau_1) + \kappa \sigma \right) \delta e^{-\delta\vartheta(t-\tau_1)} + \kappa \sigma \delta e^{-\delta(t-\tau_1)} \\ &\quad - \left(\max_{[0,1]} |f'| + \mu^2 \right) \delta e^{-\mu(c(t-\tau_1)/2+B-2C)} \\ &\geq \left[\kappa \sigma - \left(\max_{[0,1]} |f'| + \mu^2 \right) e^{-\mu(B-2C)} \right] \delta e^{-\mu c(t-\tau_1)/2} \geq 0. \end{aligned}$$

If $\bar{\xi}(t, x) \geq C$, one has $0 < \phi(\bar{\xi}(t, x)) \leq \delta$ and then $0 < \bar{u}(t, x) \leq 3\delta$. Due to (5.47), (5.50)–(5.51), as well as (5.62), an analogous argument as above leads to

$$\mathcal{L}\bar{u}(t, x) \geq \left(- \frac{f'(0)}{2} - \delta \vartheta'(t-\tau_1) \right) \delta e^{-\delta\vartheta(t-\tau_1)} + \left(- \frac{f'(0)}{2} - \mu^2 \right) \delta e^{-\mu(|x|-L)} \geq 0.$$

If $\bar{\xi}(t, x) \leq -C$, it follows that $1 > \phi(\bar{\xi}(t, x)) \geq 1 - \delta$ and then $\bar{u}(t, x) \geq 1 - \delta$ (remember also that (t, x) is assumed to be such that $1 > \bar{u}(t, x)$). Finally, one infers from (5.47), (5.50)–(5.51) as well as (5.62) that

$$\mathcal{L}\bar{u}(t, x) \geq \left(- \frac{f'(1)}{2} - \delta \vartheta'(t-\tau_1) \right) \delta e^{-\delta\vartheta(t-\tau_1)} + \left(- \frac{f'(1)}{2} - \mu^2 \right) \delta e^{-\mu(|x|-L)} \geq 0.$$

As a consequence, we conclude that $\mathcal{L}\bar{u}(t, x) = \bar{u}_t(t, x) - \Delta \bar{u}(t, x) - f(\bar{u}(t, x)) \geq 0$ for all $t \geq \tau_1$ and $x \in \bar{\Omega}^+$ such that $|x| \geq L$ and $\bar{u}(t, x) < 1$. Since $f(1) = 0$ and $u < 1$ in $\mathbb{R} \times \bar{\Omega}$, the maximum principle then implies that

$$u(t, x) \leq \bar{u}(t, x) \leq \phi \left(|x| - c(t-\tau_1+\tau) + \frac{N-1}{c} \ln(t-\tau_1+\tau) - L - B + C - \varrho(t-\tau_1) \right) + \delta e^{-\delta\vartheta(t-\tau_1)} + \delta e^{-\mu(|x|-L)}$$

for all $t \geq \tau_1$ and $x \in \bar{\Omega}^+$ such that $|x| \geq L$. Finally, since ϕ is decreasing, (5.48) holds by

taking $z_1 = -L - B + C - \varrho(+\infty)$.

Step 3: proof of (5.49). Since $u(t, \cdot) \rightarrow 1$ as $t \rightarrow +\infty$ locally uniformly in $\bar{\Omega}$ by the complete propagation condition (5.16), there exists $\tau_2 > 0$ such that

$$u(t, x) \geq 1 - \delta \text{ for all } t \geq \tau_2 \text{ and } x \in \bar{\Omega}^+ \text{ with } L \leq |x| \leq L + B + c\tau - \frac{N-1}{c} \ln \tau. \quad (5.63)$$

For $t \geq \tau_2$ and $x \in \bar{\Omega}^+$ with $|x| \geq L$, let us set

$$\underline{u}(t, x) = \max\left(\phi(\underline{\xi}(t, x)) - \delta e^{-\delta\vartheta(t-\tau_2)} - \delta e^{-\mu(|x|-L)}, 0\right),$$

where

$$\underline{\xi}(t, x) = \zeta(t - \tau_2, x) + \varrho(t - \tau_2) = |x| - c(t - \tau_2 + \tau) + \frac{N-1}{c} \ln(t - \tau_2 + \tau) - L - B + C + \varrho(t - \tau_2).$$

Let us now check that $\underline{u}(t, x)$ is a subsolution of the problem satisfied by $u(t, x)$ for $t \geq \tau_2$ and $x \in \bar{\Omega}^+$ with $|x| \geq L$.

Let us first check the initial and boundary conditions. At time $t = \tau_2$, on the one hand, it follows from (5.63) that, for every $x \in \bar{\Omega}^+$ with $L \leq |x| \leq L + B + c\tau - ((N-1)/c) \ln \tau$, there holds

$$u(\tau_2, x) \geq 1 - \delta \geq 1 - \delta - \delta e^{-\mu(|x|-L)} \geq \underline{u}(\tau_2, x).$$

On the other hand, for every $x \in \bar{\Omega}^+$ such that $|x| \geq L + B + c\tau - ((N-1)/c) \ln \tau$, one has

$$\underline{\xi}(\tau_2, x) = |x| - c\tau + ((N-1)/c) \ln \tau - L - B + C \geq C,$$

and it then follows from (5.52) that $\underline{u}(\tau_2, x) \leq \max(\delta - \delta - \delta e^{-\mu(|x|-L)}, 0) = 0 < u(\tau_2, x)$. Therefore, $\underline{u}(\tau_2, x) \leq u(\tau_2, x)$ for all $x \in \bar{\Omega}^+$ with $|x| \geq L$. Next, for $t \geq \tau_2$ and $x \in \bar{\Omega}^+$ with $|x| = L$, one has $\underline{u}(t, x) \leq 1 - \delta e^{-\delta\vartheta(t-\tau_2)} - \delta < 1 - \delta \leq u(t, x)$ due to (5.63). Moreover, it can be easily deduced that $\nu(x) \cdot \nabla \underline{u}(t, x) = 0$ for every $t \geq \tau_2$ and $x \in \partial\Omega^+$ such that $|x| > L$ and $\underline{u}(t, x) > 0$.

Let us now check that $\mathcal{L}\underline{u}(t, x) = \underline{u}_t(t, x) - \Delta \underline{u}(t, x) - f(\underline{u}(t, x)) \leq 0$ for all $t \geq \tau_2$ and $x \in \bar{\Omega}^+$ such that $|x| \geq L$ and $\underline{u}(t, x) > 0$. A straightforward computation shows that, for such a (t, x) ,

$$\begin{aligned} \mathcal{L}\underline{u}(t, x) &= f(\phi(\underline{\xi}(t, x))) - f(\underline{u}(t, x)) + \delta^2 \vartheta'(t - \tau_2) e^{-\delta\vartheta(t-\tau_2)} + \mu^2 \delta e^{-\mu(|x|-L)} \\ &\quad - \frac{N-1}{|x|} \mu \delta e^{-\mu(|x|-L)} + \left(\varrho'(t - \tau_2) - \underbrace{\left(\frac{N-1}{|x|} - \frac{N-1}{c(t - \tau_2 + \tau)} \right)}_{=A(t-\tau_2, x) \leq (N-1)/L} \right) \phi'(\underline{\xi}(t, x)). \end{aligned}$$

As in Step 2, three cases can occur, namely: either $\zeta(t - \tau_2, x) > M + \vartheta(t - \tau_2)$, or

5. Reaction-diffusion fronts in funnel-shaped domains

$\zeta(t - \tau_2, x) < -M - \vartheta(t - \tau_2)$, or $|\zeta(t - \tau_2, x)| \leq M + \vartheta(t - \tau_2)$.

Consider firstly the case

$$\zeta(t - \tau_2, x) > M + \vartheta(t - \tau_2).$$

One then has $\underline{\xi}(t, x) \geq \zeta(t - \tau_2, x) > M + \vartheta(t - \tau_2) > M_2 + \vartheta(t - \tau_2) \geq C$. Hence, $0 < \phi(\underline{\xi}(t, x)) \leq \delta$ and then $\underline{u}(t, x) \leq \delta$ (remember also that (t, x) is assumed to be such that $0 < \underline{u}(t, x)$). One deduces from (5.51) that $f(\phi(\underline{\xi}(t, x))) - f(\underline{u}(t, x)) \leq (f'(0)/2)(\delta e^{-\delta\vartheta(t-\tau_2)} + \delta e^{-\mu(|x|-L)})$. Moreover, by virtue of (5.52) and (5.57) one has

$$-A(t - \tau_2, x) \phi'(\underline{\xi}(t, x)) \leq \frac{N-1}{L} K e^{-\mu^* \underline{\xi}(t, x)/2} \leq \frac{N-1}{L} K e^{-\mu^*(M_2 + \vartheta(t-\tau_2))/2} \leq \delta^2 e^{-\delta\vartheta(t-\tau_2)}.$$

Therefore, it follows from (5.47), (5.50)–(5.51), (5.59), as well as the negativity of ϕ' and $f'(0)$, that

$$\begin{aligned} \mathcal{L}\underline{u}(t, x) &\leq \frac{f'(0)}{2} (\delta e^{-\delta\vartheta(t-\tau_2)} + \delta e^{-\mu(|x|-L)}) + \delta^2 \vartheta'(t - \tau_2) e^{-\delta\vartheta(t-\tau_2)} + \mu^2 \delta e^{-\mu(|x|-L)} \\ &\quad - \frac{N-1}{|x|} \mu \delta e^{-\mu(|x|-L)} + \varrho'(t - \tau_2) \phi'(\underline{\xi}(t, x)) + \delta^2 e^{-\delta\vartheta(t-\tau_2)} \\ &\leq \left(\frac{f'(0)}{2} + \delta \vartheta'(t - \tau_2) + \delta \right) \delta e^{-\delta\vartheta(t-\tau_2)} + \left(\frac{f'(0)}{2} + \mu^2 \right) \delta e^{-\mu(|x|-L)} \leq 0. \end{aligned}$$

Consider secondly the case

$$\zeta(t - \tau_2, x) < -M - \vartheta(t - \tau_2).$$

One then has $\underline{\xi}(t, x) < -M - \vartheta(t - \tau_2) + \varrho(+\infty) \leq -C$, which implies $1 > \phi(\underline{\xi}(t, x)) \geq 1 - \delta$ and then $1 > \underline{u}(t, x) \geq 1 - 3\delta$. By (5.51) there holds $f(\phi(\underline{\xi}(t, x))) - f(\underline{u}(t, x)) \leq (f'(1)/2)(\delta e^{-\delta\vartheta(t-\tau_2)} + \delta e^{-\mu(|x|-L)})$. One also infers from (5.52) and (5.60) that

$$-A(t - \tau_2, x) \phi'(\underline{\xi}(t, x)) \leq \frac{N-1}{L} K e^{\mu^* \underline{\xi}(t, x)/2} \leq \frac{N-1}{L} K e^{\mu^*(-M - \vartheta(t-\tau_2) + \varrho(+\infty))/2} \leq \delta^2 e^{-\delta\vartheta(t-\tau_2)}.$$

It then follows from (5.47), (5.50)–(5.51), (5.59), as well as the negativity of ϕ' and $f'(1)$, that

$$\begin{aligned} \mathcal{L}\underline{u}(t, x) &\leq \frac{f'(1)}{2} (\delta e^{-\delta\vartheta(t-\tau_2)} + \delta e^{-\mu(|x|-L)}) + \delta^2 \vartheta'(t - \tau_2) e^{-\delta\vartheta(t-\tau_2)} + \mu^2 \delta e^{-\mu(|x|-L)} \\ &\quad - \frac{N-1}{|x|} \mu \delta e^{-\mu(|x|-L)} + \varrho'(t - \tau_2) \phi'(\underline{\xi}(t, x)) + \delta^2 e^{-\delta\vartheta(t-\tau_2)} \\ &\leq \left(\frac{f'(1)}{2} + \delta \vartheta'(t - \tau_2) + \delta \right) \delta e^{-\delta\vartheta(t-\tau_2)} + \left(\frac{f'(1)}{2} + \mu^2 \right) \delta e^{-\mu(|x|-L)} \leq 0. \end{aligned}$$

Eventually, let us consider the case that

$$|\zeta(t - \tau_2, x)| \leq M + \vartheta(t - \tau_2).$$

One then observes from the definitions of Λ and ϱ in (5.58)–(5.59) that in this range there holds

$$\varrho'(t - \tau_2) - A(t - \tau_2, x) \geq \sigma\delta(e^{-\delta\vartheta(t-\tau_2)} + e^{-\delta(t-\tau_2)}) > 0. \quad (5.64)$$

Similarly as the preceding step, three subcases may occur. If $-C \leq \underline{\xi}(t, x) \leq C$, one then has

$$\begin{aligned} |x| - L &\geq c(t - \tau_2 + \tau) - \frac{N-1}{c} \ln(t - \tau_2 + \tau) + B - 2C - \varrho(t - \tau_2) \\ &\geq \frac{c}{2}(t - \tau_2 + \tau) + B - 2C - \varrho(+\infty) \geq \frac{c}{2}(t - \tau_2) + B - 2C - \varrho(+\infty) \end{aligned}$$

thanks to (5.55), whence $e^{-\mu(|x|-L)} \leq e^{-\mu(c(t-\tau_2)/2+B-2C-\varrho(+\infty))}$. Moreover, $\phi'(\underline{\xi}(t, x)) \leq -\kappa < 0$ and $f(\phi(\underline{\xi}(t, x))) - f(\underline{u}(t, x)) \leq (\max_{[0,1]} |f'|)(\delta e^{-\delta\vartheta(t-\tau_2)} + \delta e^{-\mu(|x|-L)})$. Therefore, since $B \geq 2C + \varrho(+\infty)$, one infers from (5.47), (5.51), (5.54) and (5.64) that

$$\begin{aligned} \mathcal{L}\underline{u}(t, x) &\leq \left(\max_{[0,1]} |f'| \right) (\delta e^{-\delta\vartheta(t-\tau_2)} + \delta e^{-\mu(|x|-L)}) + \delta^2 \vartheta'(t - \tau_2) e^{-\delta\vartheta(t-\tau_2)} + \mu^2 \delta e^{-\mu(|x|-L)} \\ &\quad - \frac{N-1}{|x|} \mu \delta e^{-\mu(|x|-L)} - \kappa \sigma \delta (e^{-\delta\vartheta(t-\tau_2)} + e^{-\delta(t-\tau_2)}) \\ &\leq \left(\max_{[0,1]} |f'| + \delta \vartheta'(t - \tau_2) - \kappa \sigma \right) \delta e^{-\delta\vartheta(t-\tau_2)} + \left(\max_{[0,1]} |f'| + \mu^2 \right) \delta e^{-\mu(|x|-L)} - \kappa \sigma \delta e^{-\delta(t-\tau_2)} \\ &\leq \left(\max_{[0,1]} |f'| + \mu^2 \right) \delta e^{-\mu(c(t-\tau_2)/2+B-2C-\varrho(+\infty))} - \kappa \sigma \delta e^{-\delta(t-\tau_2)} \\ &\leq \left[\left(\max_{[0,1]} |f'| + \mu^2 \right) e^{-\mu(B-2C-\varrho(+\infty))} - \kappa \sigma \right] \delta e^{-\delta(t-\tau_2)} \leq 0. \end{aligned}$$

If $\underline{\xi}(t, x) \geq C$, one has $0 < \phi(\underline{\xi}(t, x)) \leq \delta$ and $0 < \underline{u}(t, x) \leq \delta$. Moreover, one infers from (5.51) that $f(\phi(\underline{\xi}(t, x))) - f(\underline{u}(t, x)) \leq (f'(0)/2)(\delta e^{-\delta\vartheta(t-\tau_2)} + \delta e^{-\mu(|x|-L)})$. Therefore it follows from (5.47), (5.50)–(5.51) and (5.64), as well as the negativity of ϕ' and $f'(0)$, that

$$\begin{aligned} \mathcal{L}\underline{u}(t, x) &\leq \frac{f'(0)}{2} (\delta e^{-\delta\vartheta(t-\tau_2)} + \delta e^{-\mu(|x|-L)}) + \delta^2 \vartheta'(t - \tau_2) e^{-\delta\vartheta(t-\tau_2)} + \mu^2 \delta e^{-\mu(|x|-L)} \\ &\leq \left(\frac{f'(0)}{2} + \delta \vartheta'(t - \tau_2) \right) \delta e^{-\delta\vartheta(t-\tau_2)} + \left(\frac{f'(0)}{2} + \mu^2 \right) \delta e^{-\mu(|x|-L)} \leq 0. \end{aligned}$$

If $\underline{\xi}(t, x) \leq -C$, one has $1 > \phi(\underline{\xi}(t, x)) \geq 1 - \delta$ and then $1 > \underline{u}(t, x) \geq 1 - 3\delta$. By virtue

5. Reaction-diffusion fronts in funnel-shaped domains

of (5.47), (5.50)–(5.51) and (5.64), as well as the negativity of ϕ' and $f'(1)$, one gets that

$$\mathcal{L}\underline{u}(t, x) \leq \left(\frac{f'(1)}{2} + \delta \vartheta'(t - \tau_2) \right) \delta e^{-\delta \vartheta(t - \tau_2)} + \left(\frac{f'(1)}{2} + \mu^2 \right) \delta e^{-\mu(|x| - L)} \leq 0.$$

Consequently, we conclude that $\mathcal{L}\underline{u}(t, x) = \underline{u}_t(t, x) - \Delta \underline{u}(t, x) - f(\underline{u}(t, x)) \leq 0$ for all $t \geq \tau_2$ and $x \in \overline{\Omega^+}$ such that $|x| \geq L$ and $\underline{u}(t, x) > 0$. Since $f(0) = 0$ and $u > 0$ in $\mathbb{R} \times \overline{\Omega}$, the maximum principle then implies that

$$u(t, x) \geq \underline{u}(t, x) \geq \phi \left(|x| - c(t - \tau_2 + \tau) + \frac{N-1}{c} \ln(t - \tau_2 + \tau) - L - B + C + \varrho(t - \tau_2) \right) - \delta e^{-\delta \vartheta(t - \tau_2)} - \delta e^{-\mu(|x| - L)}$$

for all $t \geq \tau_2$ and $x \in \overline{\Omega^+}$ such that $|x| \geq L$. Choosing $z_2 = -L$, property (5.49) then follows from the fact that $B \geq 2C + \varrho(+\infty) \geq C + \varrho(+\infty)$ and the negativity of ϕ' . The proof of Lemma 5.20 is thereby complete. \square

Proof of Theorem 5.6

Let Ω be a funnel-shaped domain satisfying (5.7)–(5.8) with $\alpha > 0$, and let u be the solution of (5.1) with past condition (5.9), given in Proposition 5.2. One assumes that u propagates completely in the sense of (5.16). First of all, we recall from (5.43) that, for every $\tau \in \mathbb{R}$, $u(t, x) \rightarrow 1$ as $x_1 \rightarrow -\infty$ uniformly with respect to $t \geq \tau$. Together with (5.16), one infers that

$$\inf_{\overline{\Omega^-} \cup \{x \in \overline{\Omega^+} : |x| \leq L\}} u(t, \cdot) \rightarrow 1 \quad \text{as } t \rightarrow +\infty.$$

With Lemma 5.20 and the limits $\phi(-\infty) = 1$, $\phi(+\infty) = 0$, it follows that, for any $\lambda \in (0, 1)$, there is $r_0 > 0$ such that the upper level set $\mathcal{U}_\lambda(t)$ defined in (5.19) satisfies (5.23) for all t large enough. In other words, the Hausdorff distance between the level set $\mathcal{E}_\lambda(t)$ and the expanding spherical surface of radius $ct - ((N-1)/c) \ln t$ in $\overline{\Omega^+}$ remains bounded as $t \rightarrow +\infty$.

Furthermore, from (5.26), (5.29) and the positivity of u , one gets that, for any $\eta > 0$, there is $t_\eta < 0$ such that $0 < u(t, \cdot) \leq \eta$ in $\overline{\Omega^+}$ for all $t \leq t_\eta$. In particular, by choosing any η small enough so that $f < 0$ in $(0, \eta]$, it then easily follows from the maximum principle and parabolic estimates that $u(t, x) \rightarrow 0$ as $x_1 \rightarrow +\infty$, uniformly with respect to $t \leq t_\eta$, and then also locally uniformly in $t \in \mathbb{R}$ again from parabolic estimates. Since $u(t, x) \rightarrow 1$ as $x_1 \rightarrow -\infty$ (at least) locally uniformly in $t \in \mathbb{R}$ by (5.43), and since (5.9) and (5.23) hold, it is elementary to check that u is a transition front in the sense of Definition 5.1 with sets Γ_t and Ω_t^\pm defined by (5.20)–(5.21). Moreover, u then has a global mean speed equal to c .

To complete the proof of Theorem 5.6, it remains to show that u converges locally uniformly along any of its level sets to planar front profiles as $t \rightarrow +\infty$. To do so, let $\tau > 0$, $\tau_1 \in \mathbb{R}$, $\tau_2 \in \mathbb{R}$, $z_1 \in \mathbb{R}$, $z_2 \in \mathbb{R}$, $\delta > 0$ and $\mu > 0$ be as in Lemma 5.20. For $t \geq \max\{\tau_1, \tau_2\}$

and $x \in \overline{\Omega^+}$ with $|x| \geq L$, there holds

$$\begin{aligned} & \phi\left(|x| - c(t - \tau_2 + \tau) + \frac{N-1}{c} \ln(t - \tau_2 + \tau) + z_2\right) - \delta e^{-\delta\vartheta(t-\tau_2)} - \delta e^{-\mu(|x|-L)} \\ & \leq u(t, x) \leq \phi\left(|x| - c(t - \tau_1 + \tau) + \frac{N-1}{c} \ln(t - \tau_1 + \tau) + z_1\right) + \delta e^{-\delta\vartheta(t-\tau_1)} + \delta e^{-\mu(|x|-L)}. \end{aligned} \quad (5.65)$$

Consider now any $\lambda \in (0, 1)$, any sequence $(t_n)_{n \in \mathbb{N}}$ such that $t_n \rightarrow +\infty$ as $n \rightarrow +\infty$, and any sequence $(x_n)_{n \in \mathbb{N}}$ in $\overline{\Omega}$ such that $u(t_n, x_n) = \lambda$. From the properties of the previous paragraphs, one infers that $x_n \in \overline{\Omega^+}$ for all n large enough, and $|x_n| \rightarrow +\infty$ as $n \rightarrow +\infty$. Therefore, up to extraction of a subsequence, two cases can occur: either $d(x_n, \partial\Omega) \rightarrow +\infty$ as $n \rightarrow +\infty$, or $\sup_{n \in \mathbb{N}} d(x_n, \partial\Omega) < +\infty$.

Case 1: $d(x_n, \partial\Omega) \rightarrow +\infty$ as $n \rightarrow +\infty$. Up to extraction of a subsequence, there is a unit vector e such that $x_n/|x_n| \rightarrow e$ as $n \rightarrow +\infty$. From standard parabolic estimates, the functions

$$u_n(t, x) = u(t + t_n, x + x_n)$$

converge in $C_{(t,x);loc}^{1,2}(\mathbb{R} \times \mathbb{R}^N)$, up to extraction of a subsequence, to a solution u_∞ of

$$(u_\infty)_t = \Delta u_\infty + f(u_\infty) \text{ in } \mathbb{R} \times \mathbb{R}^N,$$

satisfying $u_\infty(0, 0) = \lambda$. It also follows from (5.65) that, for every $(t, x) \in \mathbb{R} \times \mathbb{R}^N$, one has

$$\begin{aligned} & \phi\left(|x + x_n| - c(t + t_n - \tau_2 + \tau) + \frac{N-1}{c} \ln(t + t_n - \tau_2 + \tau) + z_2\right) \\ & \quad - \delta e^{-\delta\vartheta(t+t_n-\tau_2)} - \delta e^{-\mu(|x+x_n|-L)} \\ & \leq u_n(t, x) \\ & \leq \phi\left(|x + x_n| - c(t + t_n - \tau_1 + \tau) + \frac{N-1}{c} \ln(t + t_n - \tau_1 + \tau) + z_1\right) \\ & \quad + \delta e^{-\delta\vartheta(t+t_n-\tau_1)} + \delta e^{-\mu(|x+x_n|-L)} \end{aligned} \quad (5.66)$$

for all n large enough. Since $u_n(0, 0) = \lambda \in (0, 1)$ for all $n \in \mathbb{N}$, one gets that, for every $t_0 \in \mathbb{R}$, the sequence $(|x_n| - c(t_n + t_0) + ((N-1)/c) \ln(t_n + t_0))_{n \in \mathbb{N}}$ is bounded. Moreover, since $\ln(t + t_n + t_0) - \ln(t_n + t_0) \rightarrow 0$ as $n \rightarrow +\infty$ for every $(t_0, t) \in \mathbb{R}^2$, and since $|x + x_n| = |x_n| + x \cdot x_n/|x_n| + o(1) = |x_n| + x \cdot e + o(1)$ as $n \rightarrow +\infty$ for every $x \in \mathbb{R}^N$, the passage to the limit as $n \rightarrow +\infty$ in (5.66) yields the existence of some real numbers A and B such that, for all $(t, x) \in \mathbb{R} \times \mathbb{R}^N$,

$$\phi(x \cdot e - ct + A) \leq u_\infty(t, x) \leq \phi(x \cdot e - ct + B).$$

5. Reaction-diffusion fronts in funnel-shaped domains

One concludes from [18, Theorem 3.1] and the property $u_\infty(0, 0) = \lambda$, that

$$u_\infty(t, x) = \phi(x \cdot e - ct + \phi^{-1}(\lambda)) \quad \text{for all } (t, x) \in \mathbb{R} \times \mathbb{R}^N.$$

Consequently,

$$u(t + t_n, x + x_n) - \phi(x \cdot e - ct + \phi^{-1}(\lambda)) \rightarrow 0 \text{ in } C_{(t,x);loc}^{1,2}(\mathbb{R} \times \mathbb{R}^N) \text{ as } n \rightarrow +\infty.$$

The previous limit, together with standard parabolic estimates and the compactness of the unit sphere of \mathbb{R}^N , yields the desired conclusion (5.22).

Case 2: $\sup_{n \in \mathbb{N}} d(x_n, \partial\Omega) < +\infty$. Up to extraction of a subsequence, one has $x_n/|x_n| \rightarrow e$ as $n \rightarrow +\infty$, where $e = (e_1, e')$ is a unit vector such that $e_1 > 0$ and $|e'| = e_1 \tan \alpha$. From standard parabolic estimates, there are then an open half-space H of \mathbb{R}^N such that e is parallel to ∂H and a $C_{(t,x)}^{1,2}(\mathbb{R} \times \overline{H})$ solution u_∞ of

$$\begin{cases} (u_\infty)_t = \Delta u_\infty + f(u_\infty) & \text{in } \mathbb{R} \times \overline{H}, \\ \nu \cdot \nabla u_\infty = 0 & \text{on } \mathbb{R} \times \partial H, \end{cases} \quad (5.67)$$

such that, up to extraction of a subsequence, $\|u(\cdot + t_n, \cdot + x_n) - u_\infty\|_{C_{(t,x)}^{1,2}(K \cap (\mathbb{R} \times (\overline{\Omega} - x_n)))} \rightarrow 0$ as $n \rightarrow +\infty$ for every compact set $K \subset \mathbb{R} \times \overline{H}$. Following an analogous analysis as the preceding case, it comes that

$$\phi(x \cdot e - ct + A) \leq u_\infty(t, x) \leq \phi(x \cdot e - ct + B) \quad \text{for all } (t, x) \in \mathbb{R} \times \overline{H}, \quad (5.68)$$

for some real numbers A and B . Let us now call \mathcal{R} the orthogonal reflection of \mathbb{R}^N with respect to the hyperplane ∂H , and let us define

$$v_\infty(t, x) = \begin{cases} u_\infty(t, x) & \text{if } (t, x) \in \mathbb{R} \times \overline{H}, \\ u_\infty(t, \mathcal{R}x) & \text{if } (t, x) \in \mathbb{R} \times (\mathbb{R}^N \setminus \overline{H}), \end{cases}$$

Thanks to the Neumann boundary conditions satisfied by u_∞ on $\mathbb{R} \times \partial H$, the function v_∞ is then a $C_{(t,x)}^{1,2}(\mathbb{R} \times \mathbb{R}^N)$ solution of the equation $(v_\infty)_t = \Delta v_\infty + f(v_\infty)$ in $\mathbb{R} \times \mathbb{R}^N$. Since e is parallel to ∂H , one also gets from (5.68) that $\phi(x \cdot e - ct + A) \leq v_\infty(t, x) \leq \phi(x \cdot e - ct + B)$ for all $(t, x) \in \mathbb{R} \times \mathbb{R}^N$. It follows as in the previous case that $v_\infty(t, x) = \phi(x \cdot e - ct + \phi^{-1}(\lambda))$ for all $(t, x) \in \mathbb{R} \times \mathbb{R}^N$, that is,

$$u_\infty(t, x) = \phi(x \cdot e - ct + \phi^{-1}(\lambda)) \quad \text{for all } (t, x) \in \mathbb{R} \times \overline{H},$$

which yields the desired conclusion. The proof of Theorem 5.6 is thereby complete. \square

5.5 Sufficient conditions on (R, α) for complete propagation or for blocking

In this section, we show Theorems 5.8 and 5.9, which provide sufficient conditions on the parameters (R, α) such that the solutions u of (5.1) and (5.9) given in Proposition 5.2 propagate completely or are blocked.

5.5.1 Complete propagation for $R \geq R_0$ and $\alpha \in (0, \pi/2)$: proof of Theorem 5.8

Consider any $\alpha \in (0, \pi/2)$, and assume that $R \geq R_0$, where R_0 is given in Lemma 5.14. Remember that the limit $0 < u_\infty(x) \leq 1$ of $u(t, x)$ as $t \rightarrow +\infty$ solves (5.17) and $u_\infty(x) \rightarrow 1$ as $x_1 \rightarrow -\infty$. It then follows from Lemmas 5.14 and 5.16, with $x_0 = (-A, 0, \dots, 0)$ and $A > 0$ large enough, that $u_\infty \equiv 1$ in $\bar{\Omega}$, that is, u propagates completely. \square

5.5.2 Blocking for $R \ll 1$ and α not too small: proof of Theorem 5.9

This subsection is devoted to the proof of Theorem 5.9. Throughout this subsection, we assume that $N \geq 3$, and we are given

$$\alpha_* \in \left(0, \frac{\pi}{2}\right) \text{ and } L_* > 0.$$

We will consider domains Ω satisfying (5.7)–(5.8) whose left parts $\Omega^- = \{x \in \Omega : x_1 \leq 0\}$ have cross sections of small radius R , whereas the angles α of the right parts $\Omega^+ = \{x \in \Omega : x_1 > 0\}$ are not too small, namely

$$\alpha_* \leq \alpha < \frac{\pi}{2}.$$

We also always assume that

$$0 < R < L \leq L_*$$

in (5.7)–(5.8). We then aim at establishing the existence of a non-constant supersolution of (5.17) that will block the propagation of the solution u of (5.1) satisfying the past condition (5.9). More precisely, we will prove that, when the measure $|\{x \in \Omega : -1 < x_1 < 0\}|$ is sufficiently small (that is, when $R > 0$ is small enough), then there exists a supersolution \bar{u} of (5.17) such that $\bar{u}(x) = 1$ for all $x \in \bar{\Omega}$ with $x_1 \leq -1$ and $\bar{u}(x) \rightarrow 0$ as $x_1 \rightarrow +\infty$. The proof is based on the construction of solutions of reduced problems in truncated domains, which is itself based on variational arguments as in [20, 11].

5. Reaction-diffusion fronts in funnel-shaped domains

Some notations

To apply this scheme, let us first list the definitions of some sets that will be used in the sequel:

$$\left\{ \begin{array}{ll} \Omega_{R,1}^- &= \{x \in \Omega : -1 < x_1 \leq 0\}, \\ \Gamma_{R,1}^- &= \{x \in \bar{\Omega} : x_1 = -1\}, \\ \Omega'_{R,\alpha} &= \{x \in \Omega : x_1 > -1\}, \\ \Omega'_{R,\alpha,r} &= \Omega_{R,1}^- \cup \{x \in \Omega^+ : |x| < r\} \quad \text{for } r \geq L_*, \\ C_{\alpha,r}^+ &= \{x \in \Omega^+ : |x'| < x_1 \tan \alpha, |x| < r\} \quad \text{for } r \geq L_*, \\ \Gamma_{\alpha,r}^+ &= \{x \in \bar{\Omega}^+ : |x| = r\} \quad \text{for } r \geq L_*. \end{array} \right. \quad (5.69)$$

Notice that $\Omega_{R,1}^-$ and $\Gamma_{R,1}^-$ are actually independent of α , and that $C_{\alpha,r}^+$ (a conical sector) and $\Gamma_{\alpha,r}^+$ are independent of R and L with $0 < R < L \leq L_*$ in (5.7)–(5.8).

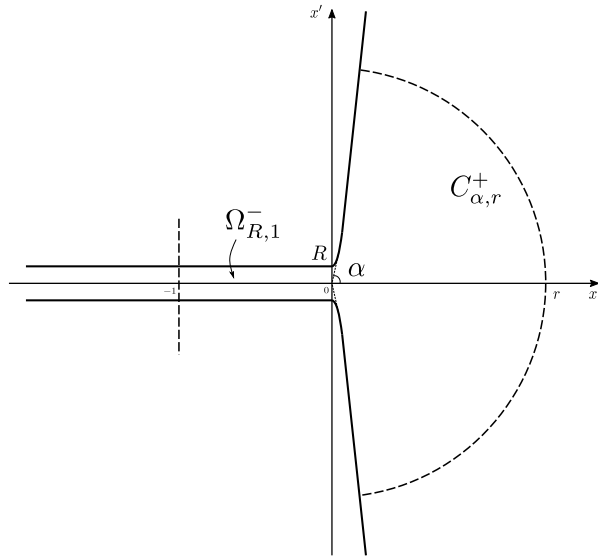

Figure 16: Illustration of some domains that will be used in the proof of Theorem 5.9.

We will consider a reduced elliptic problem in $\Omega'_{R,\alpha}$:

$$\left\{ \begin{array}{ll} \Delta w + f(w) = 0 & \text{in } \Omega'_{R,\alpha}, \\ \nu \cdot \nabla w = 0 & \text{on } \partial\Omega'_{R,\alpha} \setminus \Gamma_{R,1}^-, \\ w = 1 & \text{on } \Gamma_{R,1}^-, \\ w(x) \rightarrow 0 & \text{as } |x| \rightarrow +\infty \text{ in } \overline{\Omega'_{R,\alpha}}. \end{array} \right. \quad (5.70)$$

We shall prove the existence of a positive $C^2(\overline{\Omega'_{R,\alpha}})$ solution w of (5.70). Such a solution w , extended by 1 in $\bar{\Omega} \setminus \overline{\Omega'_{R,\alpha}}$, will give rise to a supersolution \bar{u} of (5.17) which will block the

propagation of the solution u of (5.1) with past condition (5.9).

For this purpose, we first consider the corresponding truncated problem in the domain $\Omega'_{R,\alpha,r}$ (for $r \geq L_*$), and show that the elliptic problem

$$\begin{cases} \Delta w_r + f(w_r) = 0 & \text{in } \Omega'_{R,\alpha,r}, \\ \nu \cdot \nabla w_r = 0 & \text{on } \partial\Omega'_{R,\alpha,r} \setminus (\Gamma_{R,1}^- \cup \Gamma_{\alpha,r}^+), \\ w_r = 1 & \text{on } \Gamma_{R,1}^-, \\ w_r = 0 & \text{on } \Gamma_{\alpha,r}^+, \end{cases} \quad (5.71)$$

admits a $C^2(\overline{\Omega'_{R,\alpha,r}})$ solution w_r such that $0 < w_r < 1$ in $\overline{\Omega'_{R,\alpha,r}} \setminus (\Gamma_{R,1}^- \cup \Gamma_{\alpha,r}^+)$. Then, we will prove that $w_r \rightarrow w$ as $r \rightarrow +\infty$ locally uniformly in $\overline{\Omega'_{R,\alpha}}$, with w satisfying (5.70).

Truncated problem (5.71) in $\Omega'_{R,\alpha,r}$

For any bounded measurable subset D of \mathbb{R}^N , let us define the functional

$$H^1(D) \ni w \mapsto J_D(w) = \int_D \frac{|\nabla w|^2}{2} + F(w),^6$$

where $F(t) = \int_t^1 f(s)ds$. From (5.2)–(5.3) and the affine extension of f outside the interval $[0, 1]$, there exists $\kappa > 0$ such that

$$0 \leq \kappa(t - 1)^2 \leq F(t) \leq \frac{1 + t^2}{\kappa} \quad (5.72)$$

for all $t \in \mathbb{R}$ (hence, J_D is well defined in $H^1(D)$ for every bounded measurable subset D of \mathbb{R}^N). For $r \geq L_*$, and $0 < R < L \leq L_*$ and $\alpha_* \leq \alpha < \pi/2$ in (5.7)–(5.8), define now

$$H_{R,\alpha,r} = \{w \in H^1(\Omega'_{R,\alpha,r}) : w = 1 \text{ on } \Gamma_{R,1}^- \text{ and } w = 0 \text{ on } \Gamma_{\alpha,r}^+\}, \quad (5.73)$$

where the equalities on $\Gamma_{R,1}^-$ and $\Gamma_{\alpha,r}^+$ are understood in the sense of trace. We aim at finding a local minimizer of $J_{\Omega'_{R,\alpha,r}}$ belonging to $H_{R,\alpha,r}$. That will lead to the existence of a solution to (5.71).

We start with the following result on the functional $J_{C_{\alpha,r}^+}$, where the conical sectors $C_{\alpha,r}^+$ are defined in (5.69) (we recall that these sets $C_{\alpha,r}^+$ are independent of R and L).

Lemma 5.21. *The function 0 is a strict local minimum of $J_{C_{\alpha,r}^+}$ in the space $H^1(C_{\alpha,r}^+)$ and, more precisely, there exist $\sigma > 0$ and $\delta > 0$ such that, for all $\alpha \in [\alpha_*, \pi/2)$, $r \geq L_*$, and*

⁶We equip $H^1(D)$ with the norm $\|w\|_{H^1(D)} = \sqrt{\|\nabla w\|_{L^2(D)}^2 + \|w\|_{L^2(D)}^2}$.

5. Reaction-diffusion fronts in funnel-shaped domains

$w \in H^1(C_{\alpha,r}^+)$ with $\|w\|_{H^1(C_{\alpha,r}^+)} \leq \delta$, there holds

$$J_{C_{\alpha,r}^+}(w) \geq J_{C_{\alpha,r}^+}(0) + \sigma \|w\|_{H^1(C_{\alpha,r}^+)}^2.$$

Proof. Throughout the proof, $\alpha \in [\alpha_*, \pi/2)$ and $r \geq L_*$ are arbitrary. First observe, from the Taylor expansion and the affine expansion of f outside $[0, 1]$, that there exist a continuous bounded function $\eta : \mathbb{R} \rightarrow \mathbb{R}$ such that $\eta(0) = 0$ and

$$F(t) = F(0) + F'(0)t + \frac{F''(0)}{2}t^2 + \eta(t)t^2 = F(0) - \frac{f'(0)}{2}t^2 + \eta(t)t^2$$

for all $t \in \mathbb{R}$. Therefore, by setting

$$\sigma = \min\left(\frac{1}{6}, \frac{-f'(0)}{6}\right) > 0,$$

we have

$$J_{C_{\alpha,r}^+}(w) - J_{C_{\alpha,r}^+}(0) = \int_{C_{\alpha,r}^+} \frac{|\nabla w|^2}{2} - \frac{f'(0)}{2} w^2 + \eta(w) w^2 \geq 3\sigma \|w\|_{H^1(C_{\alpha,r}^+)}^2 - \int_{C_{\alpha,r}^+} |\eta(w)| w^2 \quad (5.74)$$

for all $w \in H^1(C_{\alpha,r}^+)$.

Define

$$p^* = \frac{2N}{N-2} \in (2, +\infty).$$

From Sobolev embedding theorem and the uniform (with respect to $\alpha \in [\alpha_*, \pi/2)$) Lipschitz continuity of the conical sectors C_{α, L_*}^+ , there is a positive constant C (depending on α_* , L_* and N , but independent of $\alpha \in [\alpha_*, \pi/2)$ and $r \geq L_*$) such that

$$\|v\|_{L^{p^*}(C_{\alpha, L_*}^+)} \leq C \|v\|_{H^1(C_{\alpha, L_*}^+)}$$

for all $\alpha \in [\alpha_*, \pi/2)$ and $v \in H^1(C_{\alpha, L_*}^+)$.⁷ On the other hand, since the function η is continuous, bounded and vanishes at 0, there is a positive constant C' (independent of α and r) such that

$$|\eta(t)| \leq \sigma + C'|t|^{p^*-2}$$

for all $t \in \mathbb{R}$. Hence, for all $\alpha \in [\alpha_*, \pi/2)$, $r \geq L_*$ and $w \in H^1(C_{\alpha,r}^+)$, there holds, with

⁷We here use the assumption $N \geq 3$. In dimension $N = 2$, the sets $H^1(C_{\alpha, L_*}^+)$ are not embedded into $L^\infty(C_{\alpha, L_*}^+)$, and the following arguments would not work as such in dimension $N = 2$.

5.5. Sufficient conditions on (R, α) for complete propagation or for blocking

$$v = w(r \cdot / L_*) \in H^1(C_{\alpha, L_*}^+),$$

$$\begin{aligned} \int_{C_{\alpha, r}^+} |\eta(w)| w^2 &\leq \sigma \int_{C_{\alpha, r}^+} w^2 + C' \int_{C_{\alpha, r}^+} |w|^{p^*} \\ &\leq \sigma \|w\|_{H^1(C_{\alpha, r}^+)}^2 + \frac{C' r^N}{L_*^N} \|v\|_{L^{p^*}(C_{\alpha, L_*}^+)}^{p^*} \\ &\leq \sigma \|w\|_{H^1(C_{\alpha, r}^+)}^2 + \frac{C' C^{p^*} r^N}{L_*^N} \|v\|_{H^1(C_{\alpha, L_*}^+)}^{p^*} \\ &= \sigma \|w\|_{H^1(C_{\alpha, r}^+)}^2 + \frac{C' C^{p^*} r^N}{L_*^N} \left(\int_{C_{\alpha, r}^+} \frac{L_*^{N-2}}{r^{N-2}} |\nabla w|^2 + \int_{C_{\alpha, r}^+} \frac{L_*^N}{r^N} w^2 \right)^{p^*/2} \\ &\leq \sigma \|w\|_{H^1(C_{\alpha, r}^+)}^2 + C' C^{p^*} \left(\frac{L_*}{r} \right)^{(N-2)p^*/2-N} \|w\|_{H^1(C_{\alpha, r}^+)}^{p^*} \\ &= \sigma \|w\|_{H^1(C_{\alpha, r}^+)}^2 + C' C^{p^*} \|w\|_{H^1(C_{\alpha, r}^+)}^{p^*}. \end{aligned}$$

Together with (5.74), one gets that

$$J_{C_{\alpha, r}^+}(w) - J_{C_{\alpha, r}^+}(0) \geq 2\sigma \|w\|_{H^1(C_{\alpha, r}^+)}^2 - C' C^{p^*} \|w\|_{H^1(C_{\alpha, r}^+)}^{p^*} \geq \sigma \|w\|_{H^1(C_{\alpha, r}^+)}^2$$

for all $\alpha \in [\alpha_*, \pi/2)$, $r \geq L_*$ and $w \in H^1(C_{\alpha, r}^+)$ such that

$$\|w\|_{H^1(C_{\alpha, r}^+)} \leq \delta := \left(\frac{\sigma}{C' C^{p^*}} \right)^{1/(p^*-2)}.$$

Since the positive constants σ and δ do not depend on $\alpha \in [\alpha_*, \pi/2)$ and $r \geq L_*$, the proof of Lemma 5.21 is thereby complete. \square

Next, let us focus on the domain $\Omega'_{R, \alpha, r}$, with $0 < R < L \leq L_*$, $\alpha \in [\alpha_*, \pi/2)$, and $r \geq L_*$. We define the following function w_0 in $\Omega'_{R, \alpha, r}$ by:

$$w_0(x) = \begin{cases} -x_1 & \text{if } x \in \overline{\Omega'_{R, \alpha, r}} \text{ with } x_1 \leq 0, \\ 0 & \text{if } x \in \overline{\Omega'_{R, \alpha, r}} \text{ with } x_1 > 0. \end{cases}$$

It is immediate to see that $w_0 \in H_{R, \alpha, r}$, with $H_{R, \alpha, r}$ defined in (5.73).

Lemma 5.22. *Let $\delta > 0$ be as in Lemma 5.21. Then there exist $R_* \in (0, L_*)$ and $\gamma > 0$ such that, for every funnel-shaped domain Ω satisfying (5.7)–(5.8) with $\alpha \in [\alpha_*, \pi/2)$, $0 < R \leq R_*$ and $0 < R < L \leq L_*$, for every $r \geq L_*$, and for every $w \in H_{R, \alpha, r}$ with $\|w - w_0\|_{H^1(\Omega'_{R, \alpha, r})} = \delta$, there holds*

$$J_{\Omega'_{R, \alpha, r}}(w) \geq J_{\Omega'_{R, \alpha, r}}(w_0) + \gamma.$$

Proof. Let $\delta > 0$ and $\sigma > 0$ be as in Lemma 5.21. Throughout the proof, $\alpha \in [\alpha_*, \pi/2)$ and $r \geq L_*$ are arbitrary. We consider funnel-shaped domains Ω satisfying (5.7)–(5.8), with

5. Reaction-diffusion fronts in funnel-shaped domains

a parameter R satisfying $0 < R < L \leq L_*$, and some further restrictions on R will appear later. Consider any $w \in H_{R,\alpha,r}$ with

$$\|w - w_0\|_{H^1(\Omega'_{R,\alpha,r})} = \delta.$$

In order to estimate $J_{\Omega'_{R,\alpha,r}}(w) - J_{\Omega'_{R,\alpha,r}}(w_0)$, we decompose the integrals over two disjoint subsets of $\Omega'_{R,\alpha,r}$, namely $\Omega_{R,1}^- \cup S_{R,\alpha}^+$ and $C_{\alpha,r}^+$, with

$$S_{R,\alpha}^+ = \Omega'_{R,\alpha,r} \setminus (\Omega_{R,1}^- \cup C_{\alpha,r}^+) = \{(x_1, x') \in \mathbb{R}^N : 0 < x_1 < L \cos \alpha, x_1 \tan \alpha \leq |x'| < h(x_1)\}, \quad (5.75)$$

where the function h is as in (5.7)–(5.8) (notice that $S_{R,\alpha}^+$ depends on Ω but not on r , since $L \leq L_* \leq r$). One has

$$J_{\Omega'_{R,\alpha,r}}(w) - J_{\Omega'_{R,\alpha,r}}(w_0) = J_{\Omega_{R,1}^- \cup S_{R,\alpha}^+}(w) - J_{\Omega_{R,1}^- \cup S_{R,\alpha}^+}(w_0) + J_{C_{\alpha,r}^+}(w) - J_{C_{\alpha,r}^+}(w_0).$$

Since $\|w\|_{H^1(C_{\alpha,r}^+)} = \|w - w_0\|_{H^1(C_{\alpha,r}^+)} \leq \|w - w_0\|_{H^1(\Omega'_{R,\alpha,r})} = \delta$, Lemma 5.21 yields

$$J_{C_{\alpha,r}^+}(w) - J_{C_{\alpha,r}^+}(w_0) = J_{C_{\alpha,r}^+}(w) - J_{C_{\alpha,r}^+}(0) \geq \sigma \|w\|_{H^1(C_{\alpha,r}^+)}^2 = \sigma \|w - w_0\|_{H^1(C_{\alpha,r}^+)}^2,$$

hence

$$J_{\Omega'_{R,\alpha,r}}(w) - J_{\Omega'_{R,\alpha,r}}(w_0) \geq J_{\Omega_{R,1}^- \cup S_{R,\alpha}^+}(w) - J_{\Omega_{R,1}^- \cup S_{R,\alpha}^+}(w_0) + \sigma \|w - w_0\|_{H^1(C_{\alpha,r}^+)}^2. \quad (5.76)$$

Let us now estimate $J_{\Omega_{R,1}^- \cup S_{R,\alpha}^+}(w) - J_{\Omega_{R,1}^- \cup S_{R,\alpha}^+}(w_0)$. On the one hand, with

$$\rho := \min\left(\frac{1}{2}, \kappa\right) > 0$$

and $\kappa > 0$ as in (5.72), there holds

$$\begin{aligned} J_{\Omega_{R,1}^- \cup S_{R,\alpha}^+}(w) &= \int_{\Omega_{R,1}^- \cup S_{R,\alpha}^+} \frac{|\nabla(w-1)|^2}{2} + F(w) \geq \int_{\Omega_{R,1}^- \cup S_{R,\alpha}^+} \frac{|\nabla(w-1)|^2}{2} + \kappa (w-1)^2 \\ &\geq \rho \|w-1\|_{H^1(\Omega_{R,1}^- \cup S_{R,\alpha}^+)}^2. \end{aligned} \quad (5.77)$$

On the other hand,

$$\begin{aligned} J_{\Omega_{R,1}^- \cup S_{R,\alpha}^+}(w_0) &= \left(\int_{\Omega_{R,1}^-} \frac{|\nabla w_0|^2}{2} + F(w_0) \right) + F(0) |S_{R,\alpha}^+| \\ &\leq \left(\frac{1}{2} + \max_{[0,1]} F \right) |\Omega_{R,1}^-| + F(0) |S_{R,\alpha}^+| = \left(\frac{1}{2} + F(\theta) \right) \omega_{N-1} R^{N-1} + F(0) |S_{R,\alpha}^+|, \end{aligned}$$

5.5. Sufficient conditions on (R, α) for complete propagation or for blocking

where ω_{N-1} denotes the $(N-1)$ -dimensional Lebesgue measure of the unit Euclidean ball in \mathbb{R}^{N-1} . Since $0 < R < L \leq L_*$ and h satisfies (5.7)–(5.8), one has $0 \leq h(x_1) - x_1 \tan \alpha \leq h(0) = R$ for all $x_1 \in [0, L \cos \alpha]$, hence

$$\begin{aligned} |S_{R,\alpha}^+| &= \int_0^{L \cos \alpha} \omega_{N-1} (h(x_1)^{N-1} - (x_1 \tan \alpha)^{N-1}) dx_1 \\ &\leq \int_0^{L \cos \alpha} \omega_{N-1} ((x_1 \tan \alpha + R)^{N-1} - (x_1 \tan \alpha)^{N-1}) dx_1 \\ &= \frac{\omega_{N-1}}{N \tan \alpha} ((L \sin \alpha + R)^N - R^N - (L \sin \alpha)^N) \\ &\leq \omega_{N-1} \cot \alpha_* (L_* \sin \alpha + L_*)^{N-1} R \leq \omega_{N-1} 2^{N-1} L_*^{N-1} R \cot \alpha_*. \end{aligned}$$

Therefore,

$$J_{\Omega_{R,1}^- \cup S_{R,\alpha}^+}(w_0) \leq \left(\frac{1}{2} + F(\theta)\right) \omega_{N-1} R^{N-1} + F(0) \omega_{N-1} 2^{N-1} L_*^{N-1} R \cot \alpha_*$$

and, together with (5.77),

$$\begin{aligned} &J_{\Omega_{R,1}^- \cup S_{R,\alpha}^+}(w) - J_{\Omega_{R,1}^- \cup S_{R,\alpha}^+}(w_0) \\ &\geq \rho \|w - 1\|_{H^1(\Omega_{R,1}^- \cup S_{R,\alpha}^+)}^2 - \left(\frac{1}{2} + F(\theta)\right) \omega_{N-1} R^{N-1} - F(0) \omega_{N-1} 2^{N-1} L_*^{N-1} R \cot \alpha_* \\ &\geq \frac{\rho}{2} \|w - w_0\|_{H^1(\Omega_{R,1}^- \cup S_{R,\alpha}^+)}^2 - \rho \|w_0 - 1\|_{H^1(\Omega_{R,1}^- \cup S_{R,\alpha}^+)}^2 - \left(\frac{1}{2} + F(\theta)\right) \omega_{N-1} R^{N-1} \\ &\quad - F(0) \omega_{N-1} 2^{N-1} L_*^{N-1} R \cot \alpha_* \\ &\geq \frac{\rho}{2} \|w - w_0\|_{H^1(\Omega_{R,1}^- \cup S_{R,\alpha}^+)}^2 - \left(\frac{4\rho}{3} + \frac{1}{2} + F(\theta)\right) \omega_{N-1} R^{N-1} - (\rho + F(0)) \omega_{N-1} 2^{N-1} L_*^{N-1} R \cot \alpha_*. \end{aligned}$$

Putting the previous inequality into (5.76), one gets that

$$\begin{aligned} &J_{\Omega'_{R,\alpha,r}}(w) - J_{\Omega'_{R,\alpha,r}}(w_0) \\ &\geq \beta \|w - w_0\|_{H^1(\Omega'_{R,\alpha,r})}^2 - \left(\frac{4\rho}{3} + \frac{1}{2} + F(\theta)\right) \omega_{N-1} R^{N-1} - (\rho + F(0)) \omega_{N-1} 2^{N-1} L_*^{N-1} R \cot \alpha_* \\ &= \beta \delta^2 - \left(\frac{4\rho}{3} + \frac{1}{2} + F(\theta)\right) \omega_{N-1} R^{N-1} - (\rho + F(0)) \omega_{N-1} 2^{N-1} L_*^{N-1} R \cot \alpha_* \end{aligned}$$

with $\beta := \min(\sigma, \rho/2) > 0$.

Finally, since the positive constants β, δ, ρ are independent of α, R, L and r with $\alpha \in [\alpha_*, \pi/2)$ and $0 < R < L \leq L_* \leq r$, there are then some positive real numbers $R_* \in (0, L_*)$ and $\gamma > 0$ such that $J_{\Omega'_{R,\alpha,r}}(w) - J_{\Omega'_{R,\alpha,r}}(w_0) \geq \gamma$ for all $\alpha \in [\alpha_*, \pi/2)$, $0 < R \leq R_*$, $0 < R < L \leq L_* \leq r$ and $w \in H_{R,\alpha,r}$ with $\|w - w_0\|_{H^1(\Omega'_{R,\alpha,r})} = \delta$. The proof of Lemma 5.22 is thereby complete. \square

End of the proof of Theorem 5.9

Let $\delta > 0$, $R_* \in (0, L_*)$ and $\gamma > 0$ be as in Lemma 5.22. Let us then fix any funnel-shaped domain Ω satisfying (5.7)–(5.8) with $\alpha \in [\alpha_*, \pi/2)$, $0 < R \leq R_*$ and $0 < R < L \leq L_*$, and let us show that the solution u of (5.1) with the past condition (5.9), given in Proposition 5.2, is blocked in the sense of (5.15).

First of all, from Lemma 5.22, for any $r \geq L_*$, the nonnegative functional $J_{\Omega'_{R,\alpha,r}}$ admits a local minimizer w_r in $H_{R,\alpha,r}$ satisfying $\|w_r - w_0\|_{H^1(\Omega'_{R,\alpha,r})} < \delta$. This function w_r is then a weak solution of the elliptic problem (5.71) and, since $f > 0$ in $(-\infty, 0)$ and $f < 0$ in $(1, +\infty)$, one has $0 \leq w_r \leq 1$ almost everywhere in $\Omega'_{R,\alpha,r}$ and standard elliptic estimates imply that w_r is a classical $C^2(\overline{\Omega'_{R,\alpha,r}})$ solution of (5.71), with $0 < w_r < 1$ in $\overline{\Omega'_{R,\alpha,r}} \setminus (\Gamma_{R,1}^- \cup \Gamma_{\alpha,r}^+)$ (notice that $\Gamma_{R,1}^-$ and $\Gamma_{\alpha,r}^+$ meet $\partial\Omega$ orthogonally).

Remembering the definition of $\Omega'_{R,\alpha}$ in (5.69), it follows from standard elliptic estimates that there is a sequence $(r_n)_{n \in \mathbb{N}}$ diverging to $+\infty$ such that the functions w_{r_n} converge in $C_{loc}^2(\overline{\Omega'_{R,\alpha}})$ to a $C^2(\overline{\Omega'_{R,\alpha}})$ function w solving

$$\begin{cases} \Delta w + f(w) = 0 & \text{in } \Omega'_{R,\alpha}, \\ \nu \cdot \nabla w = 0 & \text{on } \partial\Omega'_{R,\alpha} \setminus \Gamma_{R,1}^-, \\ w = 1 & \text{on } \Gamma_{R,1}^-, \end{cases} \quad (5.78)$$

and $0 < w \leq 1$ in $\overline{\Omega'_{R,\alpha}}$ from the strong maximum principle. Furthermore, for any bounded measurable set $D \subset \Omega^+$, one has, for all n large enough, $D \subset \Omega'_{R,\alpha,r_n}$ and $\|w_{r_n}\|_{L^2(D)} = \|w_{r_n} - w_0\|_{L^2(D)} \leq \|w_{r_n} - w_0\|_{H^1(\Omega'_{R,\alpha,r_n})} < \delta$. Hence, $\|w\|_{L^2(D)} \leq \delta$, and, since δ is independent of D , one gets that $\|w\|_{L^2(\Omega^+)} \leq \delta$ by the monotone convergence theorem. Since $|\nabla w|$ is bounded from standard elliptic estimates, one infers that $w(x) \rightarrow 0$ as $|x| \rightarrow +\infty$ in $\overline{\Omega'_{R,\alpha}}$. In other words, w solves (5.70).

We now extend w in $\overline{\Omega} \setminus \overline{\Omega'_{R,\alpha}}$ by 1, namely we define

$$\bar{u}(x) = \begin{cases} w(x) & \text{if } x \in \overline{\Omega'_{R,\alpha}}, \\ 1, & \text{if } x \in \overline{\Omega} \setminus \overline{\Omega'_{R,\alpha}}. \end{cases}$$

Since $f(1) = 0$ and $0 < w \leq 1$ is a classical solution of (5.70) in $\overline{\Omega'_{R,\alpha}}$, the function \bar{u} is a supersolution of (5.1). Finally, from the construction of u in the proof of Proposition 5.2, and in particular from (5.25), (5.27) and the fact that $w^-(t, \cdot) \rightarrow 0$ as $t \rightarrow -\infty$ locally uniformly in $\overline{\Omega}$, one has

$$u_n(-n, \cdot) \leq \bar{u} \text{ in } \overline{\Omega}$$

for all n large enough, hence $u_n(t, \cdot) \leq \bar{u}$ in $\overline{\Omega}$ for all $t \geq -n$ and all n large enough, by the maximum principle. As a consequence, $u(t, \cdot) \leq \bar{u}$ in $\overline{\Omega}$ for all $t \in \mathbb{R}$, and the large time

5.6. The set of (R, α) with complete propagation property is open in $(0, +\infty) \times (0, \pi/2)$

limit u_∞ of $u(t, \cdot)$ satisfies $0 < u_\infty \leq \bar{u}$ in $\bar{\Omega}$. Thus, $0 < u_\infty \leq w$ in $\overline{\Omega'_{R,\alpha}}$ and $u_\infty(x) \rightarrow 0$ as $x_1 \rightarrow +\infty$ in $\bar{\Omega}$. The proof of Theorem 5.9 is thereby complete.

5.6 The set of (R, α) with complete propagation property is open in $(0, +\infty) \times (0, \pi/2)$

This section is devoted to the proof of Theorem 5.10. The main strategy is to argue by way of contradiction and make use of Corollary 5.13 and Lemma 5.16. So, let $(R, \alpha) \in (0, +\infty) \times (0, \pi/2)$ be such that the solution u of (5.1) with past condition (5.9) propagates completely in the sense of (5.16), and let us assume that there is a sequence $(R_n, \alpha_n)_{n \in \mathbb{N}}$ in $(0, +\infty) \times (0, \pi/2)$ converging to (R, α) , such that the solutions u_n of (5.1) (in $\mathbb{R} \times \overline{\Omega_{R_n, \alpha_n}}$) with past conditions (5.9) do not propagate completely. From the dichotomy result of Theorem 5.3, this means that each solution u_n is blocked, that is, there is a $C^2(\overline{\Omega_{R_n, \alpha_n}})$ solution $0 < u_{\infty, n} < 1$ of (5.17) in $\overline{\Omega_{R_n, \alpha_n}}$ such that $u_n(t, x) \rightarrow u_{\infty, n}(x)$ in $C^2_{loc}(\overline{\Omega_{R_n, \alpha_n}})$ as $t \rightarrow +\infty$ and

$$u_{\infty, n}(x) \rightarrow 0 \text{ as } x_1 \rightarrow +\infty \text{ with } x \in \overline{\Omega_{R_n, \alpha_n}}.$$

On the other hand, by assumption of the theorem, the functions h_n involved in the definitions (5.7)–(5.8) of the sets Ω_{R_n, α_n} converge (in $C^{2, \beta}_{loc}(\mathbb{R})$) to the function h involved in the definition of the set $\Omega_{R, \alpha}$. In particular, since $\alpha > 0$, there is a point $x_0 \in \mathbb{R}^N$ (independent of $n \in \mathbb{N}$) such that $\overline{B_{R_0}(x_0)} \subset \overline{\Omega_{R, \alpha}}$ and $\overline{B_{R_0}(x_0)} \subset \overline{\Omega_{R_n, \alpha_n}}$ for all $n \in \mathbb{N}$, where $R_0 > 0$ is given as in Lemma 5.14. It then follows from Lemmas 5.14 and 5.16 (the latter applied in Ω_{R_n, α_n}) that, for each $n \in \mathbb{N}$,

$$\frac{\min}{B_{R_0}(x_0)} u_{\infty, n} < \frac{\max}{B_{R_0}} \psi = \psi(0) < 1,$$

where the $C^2(\overline{B_{R_0}})$ function ψ is as in Lemma 5.14. From standard elliptic estimates, there is a $C^2(\overline{\Omega_{R, \alpha}})$ solution $0 \leq U \leq 1$ of (5.17) in $\overline{\Omega_{R, \alpha}}$ such that, up to extraction of a subsequence, $\|u_{\infty, n} - U\|_{C^2(K \cap \overline{\Omega_{R_n, \alpha_n}})} \rightarrow 0$ as $n \rightarrow +\infty$ for every compact set $K \subset \overline{\Omega_{R, \alpha}}$. In particular, one has

$$\frac{\min}{B_{R_0}(x_0)} U \leq \psi(0) < 1. \tag{5.79}$$

Finally, remember that the functions $u_{\infty, n}(x)$ converge to 1 as $x_1 \rightarrow -\infty$ with $x \in \overline{\Omega_{R_n, \alpha_n}}$, uniformly with respect to $n \in \mathbb{N}$, from property (5.30) in the construction of the solutions u in Section 5.2. Therefore, $U(x) \rightarrow 1$ as $x_1 \rightarrow -\infty$ with $x \in \overline{\Omega_{R, \alpha}}$. Corollary 5.13 then implies that the solution u of (5.1) in $\mathbb{R} \times \overline{\Omega_{R, \alpha}}$ with past condition (5.9) satisfies $u(t, x) \leq U(x)$ for all $(t, x) \in \mathbb{R} \times \overline{\Omega_{R, \alpha}}$. The condition (5.79) then means that u does not propagate completely, which is a contradiction. The proof of Theorem 5.10 is thereby complete. \square

Chapter 6

Propagation phenomena in periodic patchy landscapes with interface conditions¹

6.1 Introduction

Reaction-diffusion equations of the type

$$u_t = \Delta u + f(u), \quad t > 0, \quad x \in \mathbb{R}^N, \quad (6.1)$$

have been introduced in the pioneering works of Fisher [77] and Kolmogorov, Petrovsky and Piskunov [108]. They are motivated by population genetics and aim at throwing light on the spatial spread of advantageous genetic features. The nonlinear reaction term considered there is that of logistic growth. Archetypes of such nonlinearities are $f(u) = u(1 - u)$ or extensions like $f(u) = u(1 - u^2)$, which are sometimes also called monostable since they have exactly one stable nonnegative steady state. Skellam [149] then investigated this type of models in order to study spatial propagation of species and proposed quantitative explanations for the spread of muskrats throughout Europe at the beginning of the 20th century.

Since these celebrated works, a vast mathematical literature has been devoted to the homogeneous equation (6.1). It is of particular interest to investigate the structure of traveling front solutions and their stability, propagation or invasion and spreading properties. The former is related to the well-known result that this equation has a family of planar traveling fronts of the form $u(t, x) = U(x \cdot e - ct)$ for any given vector of unit norm $e \in \mathbb{S}^{N-1}$, which is the direction of propagation. Here, $c > 0$ is the constant speed of the front and $U : \mathbb{R} \rightarrow (0, 1)$ is the wave profile. It was proved in [108] that, under KPP assumptions, $f(0) = f(1) = 0$

¹This is a joint work with François Hamel and Frithjof Lutscher, submitted.

6. Propagation phenomena in periodic patchy landscapes with interface conditions

and $0 < f(s) \leq f'(0)s$ in $s \in (0, 1)$, there exists a threshold speed $c^* = 2\sqrt{f'(0)} > 0$ such that no fronts exist for $c < c^*$, while for each $c \geq c^*$, there is a unique (up to shift in space or time variables) planar front of the type $U(x \cdot e - ct)$. Such fronts are stable with respect to some natural classes of perturbations; see, for instance, [36, 97, 108, 109, 142, 153]. Many papers were also dedicated to such planar fronts for other types of nonlinearities $f(\cdot)$, for example the bistable and combustion type; see, e.g., [8, 28, 75, 76, 105].

While traveling waves are interesting mathematical objects, they do not necessarily represent biologically realistic scenarios. For questions of biological invasions, it is more realistic to study how a locally introduced population would spread. Corresponding mathematical invasion and spreading properties for model (6.1) were established by Aronson and Weinberger [9]. Under the same assumptions on f as in the previous paragraph, they proved that, starting with a nonnegative, compactly supported, continuous function $u_0 \geq 0$, $u_0 \not\equiv 0$, the solution $u(t, x)$ of (6.1) spreads with speed c^* in all directions for large times. More precisely, $\max_{|x| \leq ct} |u(t, x) - 1| \rightarrow 0$ as $t \rightarrow +\infty$ for each $c \in [0, c^*)$, and $\max_{|x| \geq ct} u(t, x) \rightarrow 0$ for each $c > c^*$.

Most landscapes are not homogeneous, as model (6.1) implicitly assumes. Several possible generalizations of the equation to heterogeneous landscapes exist, for example

$$u_t = \nabla \cdot (D(x)\nabla u)u + f(x, u), \quad t > 0, \quad x \in \mathbb{R}^N, \quad (6.2)$$

in periodic media (by periodic, we mean that $D(\cdot + k) = D$ and $f(\cdot + k, s) = f(\cdot, s)$ for all $k \in L_1\mathbb{Z} \times \dots \times L_N\mathbb{Z}$ and $s \in [0, 1]$, where L_1, \dots, L_N are given positive real numbers). For such equations, standard traveling fronts do not exist in general. Instead, the notion of traveling fronts is replaced by the more general concept of pulsating fronts [146]. If a (unique) periodic positive steady state $p(x)$ of (6.2) exists, a pulsating traveling front connecting 0 and $p(x)$ is a solution of the type $u(t, x) = U(x \cdot e - ct, x)$ with $c \neq 0$ and e a unit vector representing the direction of propagation, if the function $U : \mathbb{R} \times \mathbb{R}^N \rightarrow \mathbb{R}$ satisfies

$$\begin{cases} U(-\infty, x) = p(x), \quad U(+\infty, x) = 0 \text{ uniformly in } x \in \mathbb{R}^N, \\ U(s, \cdot) \text{ is periodic in } \mathbb{R}^N \text{ for all } s \in \mathbb{R}. \end{cases}$$

Moreover, for every $x \in \mathbb{R}^N$, the function $t \mapsto u(t, x + cte)$ is in general quasi-periodic.

Berestycki, Hamel and Roques [24] gave a complete and rigorous mathematical analysis of the periodic heterogeneous model (6.2) in any space dimension. They required the coefficient functions D and f to be sufficiently smooth, yet some of their results are valid under reduced regularity assumptions. Solutions in [24] are still at least of class $C^{1,\rho}$ with respect to x for all $\rho \in (0, 1)$, while the solutions considered in the present chapter are even not continuous at all points in general, or not of class C^1 even when they are continuous after a rescaling. In [24], existence, uniqueness and stability results were established. A criterion for species

persistence and the effects of fragmentation on species survival were studied. Furthermore, the same authors studied the question of biological invasion and existence of pulsating fronts and they proved a variational formula of the minimal speed of such pulsating fronts and then analyzed the dependency of this speed on the heterogeneity of the medium [25]. We refer the reader to [17, 22, 91, 98, 103, 113, 114, 155] for more results on the existence, uniqueness and qualitative results of pulsating traveling fronts. For some results in space-time periodic media, see, e.g., [128, 130, 131]. We also refer to [17, 22, 66, 72, 74, 90, 102, 144, 156, 157, 159] for the existence and qualitative results with other types of nonlinearities or various boundary conditions in periodic domains.

While equation (6.2) and the corresponding theory is mathematically elegant, it is very difficult if not impossible to apply the model to biological invasions since the data requirements of finding diffusion coefficients and growth rates for continuously changing landscape characteristics are too costly. Alternatively, landscape ecology views natural environments as patches of homogeneous habitats such as forests, grasslands, or marshes, possibly fragmented by natural or artificial barriers like rivers or roads. Each patch is relatively homogeneous within but significantly different from adjacent patches. Shigesada, Kawasaki and Teramoto [146] used this perspective of a patchy landscape and proposed a heterogeneous extension of (6.1) with piecewise constant coefficient functions; see also [145]. For simplicity, they considered only two types of patches, arranged in a periodically alternating way. More specifically, they introduced the following equation

$$u_t = (D(x)u_x)_x + u(\mu(x) - u), \quad t > 0, \quad x \in \mathbb{R} \setminus S, \quad (6.3)$$

where $\mu(x)$ is interpreted as the intrinsic growth rate of the population, $D(x)$ is the diffusion coefficient, and S is the set of all interfaces between all adjacent patches. These functions are piecewise constant, namely, for $m \in \mathbb{Z}$,

$$\begin{cases} D(x) = d_1(> 0), & \mu(x) = \mu_1, & ml - l_1 < x < ml & \text{(in patches of type 1),} \\ D(x) = d_2(> 0), & \mu(x) = \mu_2, & ml < x < ml + l_2 & \text{(in patches of type 2),} \end{cases}$$

with $l_1, l_2 > 0$ and $l = l_1 + l_2$. Without loss of generality, one can assume that $\mu_1 \geq \mu_2$. Furthermore, if one assumes that the medium is not unfavorable everywhere, then $\mu_1 > 0$, i.e., type-1 patches support population growth and are “source” patches in biological terms. However, μ_2 can be negative, so that patches of type 2 do not support population growth and are “sink” patches in biological terms.

The above model is not complete. At the boundaries or interfaces between two patches, matching conditions must be imposed. Shigesada, Kawasaki and Teramoto [146] required

6. Propagation phenomena in periodic patchy landscapes with interface conditions

continuity of density and flux, i.e., for $t > 0$:

$$u(t, x^-) = u(t, x^+), \quad D(x^-)u_x(t, x^-) = D(x^+)u_x(t, x^+),$$

for all $x = ml$ and $x = ml + l_2$ ($m = 0, \pm 1, \pm 2, \dots$). Superscripts \pm denote one-sided limits from the right and the left, respectively. When we take $D(x) \equiv d$, $\mu(x) \equiv \mu > 0$, problem (6.3) is reduced to the Fisher-KPP equation with threshold speed $2\sqrt{d\mu}$. We shall refer to this kind of model, i.e., the differential equations combined with interface matching conditions as *patch model* or *patch problem*.

Shigesada and coauthors obtained the invasion conditions in terms of the sizes of patches, diffusivities and growth rates. They proved that the population spreads successfully if and only if the invasion condition is satisfied. Moreover, when invasion occurs, the distribution of the population initially localized in a bounded area always evolves into a pulsating front. The velocity was calculated with the aid of the dispersion relation, based on linearization at low density [146]. When diffusion is constant, the rigorous analytical results in [24] apply to this patch model, but the case of discontinuous diffusion and interface matching conditions is not covered.

Recently, Maciel and Lutscher [121] introduced novel interface matching conditions, based on the work by Ovaskainen and Cornell [133]. The population flux is still continuous at an interface, but the density is not. We will explain these conditions in detail below. These matching conditions not only allow us to include patch preference data, which are frequently collected in the field, into reaction-diffusion models, but also remove some biologically unrealistic behavior that the model with the continuous-density interface conditions above shows (see [121] for a thorough discussion). A number of recent studies use this new framework to study questions of persistence and spread [122, 5] and apply it to marine reserve design [4]. All these studies show that the correct choice of interface conditions has a crucial effect on basic quantities such as population persistence conditions and spread rates in periodic environments. Recently, Maciel and Lutscher [123] showed how different movement strategies for competing species in patchy landscapes can lead to different outcomes of competition. Maciel and coauthors found evolutionarily stable movement strategies in a two-patch landscape [120].

Our work is devoted to a rigorous analytical study of the periodic patch model with two types of alternately arranged patches in a one-dimensional habitat. The population may grow or decay, depending on patch type, and diffusivity may change between patches. The setting and assumptions will be made precise below. The aim of the present work is first to rigorously prove the well-posedness of this somewhat nonstandard patch model starting with nonnegative continuous and bounded initial data. Then we investigate the long-time behavior and spatial dynamics of this type of model in the framework of a periodic environment with monostable dynamics. We give a criterion for the existence and uniqueness of a positive

and bounded steady state. Furthermore, under the hypothesis that the species can persist, we shall prove the existence of an asymptotic spreading speed c^* of the solution to the Cauchy problem and we show that this spreading speed coincides with the minimal speed for rightward and leftward pulsating fronts. Moreover, the asymptotic spreading speed c^* can be characterized using a family of eigenvalues. To the best of our knowledge, the results that had previously been discussed only formally or observed numerically in [121], are proved rigorously here for the first time.

6.2 Model presentation and statement of the main results

6.2.1 The model and some equivalent formulations

Our model is a joint generalization of the models in [146] and [121]. We consider a patchy periodically alternating landscape consisting of two types of patches (say, type 1 and 2); see Figure 17. Each patch is homogeneous within. We denote the length of patch type i ($i = 1, 2$) by l_i so that the period is $l = l_1 + l_2$. Accordingly, the real line is divided into intervals of the form

$$I_n = [nl - l_1, nl + l_2], \quad n \in \mathbb{Z},$$

each consisting of two adjacent patches. Such intervals were called “tiles” in [54].

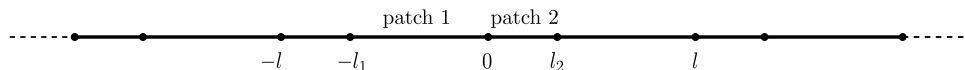

Figure 17: Schematic figure of the one-dimensional periodic patchy environment.

For $n \in \mathbb{Z}$, let $I_{1n} = (nl - l_1, nl)$ be the patches of type 1 and $I_{2n} = (nl, nl + l_2)$ be the patches of type 2. On each patch I_{in} , we denote by $v_{in} = v|_{I_{in}}$ the density of the population, by d_i the constant diffusion coefficients, and by f_i the corresponding reaction nonlinearities. Our model then reads, for $n \in \mathbb{Z}$,

$$\begin{cases} \frac{\partial v_{1n}}{\partial t} = d_1 \frac{\partial^2 v_{1n}}{\partial x^2} + f_1(v_{1n}), & t > 0, \quad x \in (nl - l_1, nl), \\ \frac{\partial v_{2n}}{\partial t} = d_2 \frac{\partial^2 v_{2n}}{\partial x^2} + f_2(v_{2n}), & t > 0, \quad x \in (nl, nl + l_2). \end{cases} \quad (6.4)$$

In (6.4), the equations for $v_{in} = v|_{I_{in}}$ are set in the open intervals $(nl - l_1, nl)$ and $(nl, nl + l_2)$, but it will eventually turn out that the constructed solutions are such that the functions v_{in} can be extended in $(0, +\infty) \times [nl - l_1, nl]$ or $(0, +\infty) \times [nl, nl + l_2]$ as $C_{t;x}^{1;2}$ functions, so that equations (6.4) will be satisfied in the closed intervals $[nl - l_1, nl]$ and $[nl, nl + l_2]$. The

6. Propagation phenomena in periodic patchy landscapes with interface conditions

matching conditions for the population density and flux at the interfaces are given by

$$\begin{cases} v_{1n}(t, x^-) = kv_{2n}(t, x^+), & d_1(v_{1n})_x(t, x^-) = d_2(v_{2n})_x(t, x^+), & t > 0, x = nl, \\ kv_{2n}(t, x^-) = v_{1(n+1)}(t, x^+), & d_2(v_{2n})_x(t, x^-) = d_1(v_{1(n+1)})_x(t, x^+), & t > 0, x = nl + l_2, \end{cases} \quad (6.5)$$

with parameter

$$k = \frac{\alpha}{1 - \alpha} \times \frac{d_2}{d_1}. \quad (6.6)$$

When $k = 1$, the model (6.4)–(6.5) is reduced to the one in [146]. Here, $\alpha \in (0, 1)$ denotes the probability that an individual at the interface chooses to move to the adjacent patch of type 1, and $1 - \alpha$ the probability that it moves to the patch of type 2. Individuals cannot stay at the interfaces. These interface conditions were derived in [133] and studied in more detail in [121]. They reflect the movement behavior of individuals when they come to the edge of a patch. With these interface conditions, the population density is discontinuous across a patch interface in the presence of patch preference and/or when the diffusion rates in these two kinds of patches are different. Throughout this chapter, we assume that the reaction terms f_i ($i = 1, 2$) have the properties:

$$f_i \in C^1(\mathbb{R}), \quad f_i(0) = 0, \quad \text{and there is } K_i > 0 \text{ such that } f_i \leq 0 \text{ in } [K_i, +\infty). \quad (6.7)$$

Without loss of generality, we will consider type-1 patches as more favorable than type-2 patches, that is, $f'_1(0) \geq f'_2(0)$. In some statements, we will also assume that type-1 patches are “source” patches, i.e., patches where the intrinsic growth rate of the population is positive ($f'_1(0) > 0$), while type-2 patches may be source patches ($f'_2(0) > 0$), or “sink” patches ($f'_2(0) < 0$), or such that $f'_2(0) = 0$. In order to investigate the long-time behavior and spatial dynamics, we will further assume in some statements that the functions f_i satisfy the strong Fisher-KPP assumption:

$$\begin{cases} \text{the functions } s \mapsto \frac{f_i(s)}{s} \text{ are non-increasing in } s > 0 \text{ for } i = 1, 2, \\ \text{and decreasing in } s > 0 \text{ for at least one } i. \end{cases} \quad (6.8)$$

For instance, f_i satisfying hypotheses (6.7)–(6.8) can be functions of the type $f_i(s) = s(\mu_i - s)$.

Since the discontinuity in the densities at the interfaces makes the problem quite delicate to study, we rescale the densities in such a way that the matching conditions become continuous in the density. More precisely, we set $u_{1n}(t, x) = v_{1n}(t, x)$ for $t \geq 0$, $x \in (nl - l_1, nl)$ and $n \in \mathbb{Z}$, and $u_{2n}(t, x) = kv_{2n}(t, x)$ for $t \geq 0$, $x \in (nl, nl + l_2)$ and $n \in \mathbb{Z}$. Then u_{1n} satisfy the same equations as v_{1n} with $\tilde{f}_1(s) = f_1(s)$, while u_{2n} satisfy the equations of v_{2n} with f_2 replaced by $\tilde{f}_2(s) = kf_2(s/k)$. We notice that \tilde{f}_i ($i = 1, 2$) satisfy the same hypotheses

as f_i with K_i replaced by \tilde{K}_i where $\tilde{K}_1 = K_1$ and $\tilde{K}_2 = kK_2$. Thanks to the change of variables, the interface conditions for the densities are now continuous; however, the flux interface conditions become discontinuous, namely,

$$\begin{cases} u_{1n}(t, x^-) = u_{2n}(t, x^+), & d_1(u_{1n})_x(t, x^-) = \frac{d_2}{k}(u_{2n})_x(t, x^+), & t > 0, x = nl, \\ u_{2n}(t, x^-) = u_{1(n+1)}(t, x^+), & \frac{d_2}{k}(u_{2n})_x(t, x^-) = d_1(u_{1(n+1)})_x(t, x^+), & t > 0, x = nl + l_2. \end{cases}$$

We drop the tilde from hereon. Notice that the properties (6.7) and (6.8) are invariant under this change. Putting it all together, we are led to the following problem:

$$\begin{cases} \frac{\partial u_{1n}}{\partial t} = d_1 \frac{\partial^2 u_{1n}}{\partial x^2} + f_1(u_{1n}), & t > 0, x \in (nl - l_1, nl), \\ \frac{\partial u_{2n}}{\partial t} = d_2 \frac{\partial^2 u_{2n}}{\partial x^2} + f_2(u_{2n}), & t > 0, x \in (nl, nl + l_2), \end{cases} \quad (6.9)$$

with continuous density conditions and discontinuous flux interface conditions,

$$\begin{cases} u_{1n}(t, x^-) = u_{2n}(t, x^+), & (u_{1n})_x(t, x^-) = \sigma(u_{2n})_x(t, x^+), & t > 0, x = nl, \\ u_{2n}(t, x^-) = u_{1(n+1)}(t, x^+), & \sigma(u_{2n})_x(t, x^-) = (u_{1(n+1)})_x(t, x^+), & t > 0, x = nl + l_2, \end{cases} \quad (6.10)$$

in which, from (6.6), we have

$$\sigma = \frac{d_2}{kd_1} = \frac{1 - \alpha}{\alpha} > 0. \quad (6.11)$$

From now on, we denote by

$$S_1 = l\mathbb{Z}$$

the interface points between $(nl - l_1, nl)$ and $(nl, nl + l_2)$, and by

$$S_2 = \{s + l_2 : s \in l\mathbb{Z}\}$$

the interface points between $(nl, nl + l_2)$ and $(nl + l_2, (n + 1)l)$. Therefore, $S = S_1 \cup S_2$ represents all the interface points in \mathbb{R} . For convenience of our analysis, by setting $u(t, x) = u_{1n}(t, x)$ for $t > 0$ and $x \in (nl - l_1, nl)$, $u(t, x) = u_{2n}(t, x)$ for $t > 0$ and $x \in (nl, nl + l_2)$, $u(t, x) = u_{1n}(t, x^-) = u_{2n}(t, x^+)$ for $t > 0$ and $x = nl$, and $u(t, x) = u_{2n}(t, x^-) = u_{1(n+1)}(t, x^+)$ for $t > 0$ and $x = nl + l_2$, we rewrite the above model (6.9)–(6.10) in the following form:

$$\begin{cases} u_t - d(x)u_{xx} = f(x, u), & t > 0, x \in \mathbb{R} \setminus S, \\ u(t, x^-) = u(t, x^+), & u_x(t, x^-) = \sigma u_x(t, x^+), & t > 0, x \in S_1, \\ u(t, x^-) = u(t, x^+), & \sigma u_x(t, x^-) = u_x(t, x^+), & t > 0, x \in S_2, \end{cases} \quad (6.12)$$

6. Propagation phenomena in periodic patchy landscapes with interface conditions

where the diffusivity d and nonlinearity f are given by

$$d(x) = \begin{cases} d_1, & x \in (nl - l_1, nl), \\ d_2, & x \in (nl, nl + l_2), \end{cases} \quad f(x, s) = \begin{cases} f_1(s), & x \in (nl - l_1, nl), \\ f_2(s), & x \in (nl, nl + l_2), \end{cases} \quad (6.13)$$

and the parameter $\sigma > 0$ is defined as in (6.11). Conditions (6.7) and (6.8) on f_i are equivalent to the following ones:

$$\begin{cases} \forall x \in \mathbb{R} \setminus S, f(x, \cdot) \in C^1(\mathbb{R}), f(x, 0) = 0, \\ \exists M = \max(K_1, K_2) > 0, \forall x \in \mathbb{R} \setminus S, \forall s \geq M, f(x, s) \leq 0, \\ \forall x \in (nl - l_1, nl), f(x, \cdot) = f_1, \quad \forall x \in (nl, nl + l_2), f(x, \cdot) = f_2. \end{cases} \quad (6.14)$$

and

$$\begin{cases} \text{the functions } s \mapsto \frac{f(x, s)}{s} \text{ are non-increasing in } s > 0 \text{ in all patches,} \\ \text{and decreasing in } s > 0 \text{ in at least one type of patch.} \end{cases} \quad (6.15)$$

From now on, we always assume that (6.14) is satisfied. Throughout this chapter, unless otherwise specified, we always write I for an arbitrary patch in \mathbb{R} of either type, i.e., either $I = (nl - l_1, nl)$ or $I = (nl, nl + l_2)$.

6.2.2 Well-posedness of the Cauchy problem (6.12)–(6.13)

Since the patch model considered in this chapter is not standard, we shall first establish the well-posedness of the Cauchy problem (6.12)–(6.13) with hypotheses (6.14) on f and with nonnegative bounded and continuous initial conditions $u_0 : \mathbb{R} \rightarrow \mathbb{R}$. Before proceeding with the analysis, we present here the definition of a classical solution to (6.12)–(6.13).

Definition 6.1. *For $T \in (0, +\infty]$, we say that a continuous function $u : [0, T) \times \mathbb{R} \rightarrow \mathbb{R}$ is a classical solution of the Cauchy problem (6.12)–(6.13) in $[0, T) \times \mathbb{R}$ with an initial condition u_0 , if $u(0, \cdot) = u_0$, if $u|_{(0, T) \times \bar{I}} \in C_{t;x}^{1;2}((0, T) \times \bar{I})$ for each patch $I = (nl - l_1, nl)$ or $(nl, nl + l_2)$, and if all identities in (6.12) are satisfied pointwise for $0 < t < T$.*

Theorem 6.2. *Under assumption (6.14), for any nonnegative bounded continuous initial condition u_0 , there is a nonnegative bounded classical solution u in $[0, +\infty) \times \mathbb{R}$ of the Cauchy problem (6.12)–(6.13) such that, for any $\tau > 0$ and any patch $I \subset \mathbb{R}$,*

$$\|u|_{[\tau, +\infty) \times \bar{I}}\|_{C_{t;x}^{1;\gamma;2;\gamma}([\tau, +\infty) \times \bar{I})} \leq C,$$

with a positive constant C depending on τ , $l_{1,2}$, $d_{1,2}$, $f_{1,2}$, σ and $\|u_0\|_{L^\infty(\mathbb{R})}$, and with a universal positive constant $\gamma \in (0, 1)$. Moreover, $u(t, x) > 0$ for all $(t, x) \in (0, +\infty) \times \mathbb{R}$ if

$u_0 \not\equiv 0$, and $u(t, x) = u(t, x + l)$ for all $(t, x) \in [0, +\infty) \times \mathbb{R}$ if $u_0(x) = u_0(x + l)$ for all $x \in \mathbb{R}$. Lastly, the solutions depend monotonically and continuously on the initial data, in the sense that if $u_0 \leq v_0$ then the corresponding solutions satisfy $u \leq v$ in $[0, +\infty) \times \mathbb{R}$, and for any $T \in (0, +\infty)$ the map $u_0 \mapsto u$ is continuous from $C^+(\mathbb{R}) \cap L^\infty(\mathbb{R})$ to $C([0, T] \times \mathbb{R}) \cap L^\infty([0, T] \times \mathbb{R})$ equipped with the sup norms, where $C^+(\mathbb{R})$ denotes the set of nonnegative continuous functions in \mathbb{R} .

We remark that the existence and uniqueness of a global bounded periodic classical solution to such a patch model was considered in [120] for (6.4)–(6.5) with periodic and possibly discontinuous initial data. By contrast, our result is established for general continuous and bounded initial data. Moreover, we also discuss the continuous dependence of solutions on initial data and give a priori estimates, which will play a critical role in the monotone semiflow argument used in the sequel. The well-posedness proof here can also be adapted to other non-periodic patch problems.

6.2.3 Existence, uniqueness and attractiveness of a positive periodic steady state

To investigate the existence and uniqueness of a positive bounded steady state as well as the large-time behavior of solutions to the Cauchy problem, we first study the following eigenvalue problem. From [121, 146] (see also Lemma 6.20 below), there exists a principal eigenvalue λ_1 , defined as the unique real number such that there exists a unique continuous function $\phi : \mathbb{R} \rightarrow \mathbb{R}$ with $\phi|_{\bar{I}} \in C^\infty(\bar{I})$ for each patch I , that satisfies

$$\begin{cases} \mathcal{L}_0\phi := -d(x)\phi'' - f_s(x, 0)\phi = \lambda_1\phi, & x \in \mathbb{R} \setminus S, \\ \phi(x^-) = \phi(x^+), \phi'(x^-) = \sigma\phi'(x^+), & x \in S_1, \\ \phi(x^-) = \phi(x^+), \sigma\phi'(x^-) = \phi'(x^+), & x \in S_2, \\ \phi(x) \text{ is periodic, } \phi > 0, \|\phi\|_{L^\infty(\mathbb{R})} = 1. \end{cases} \quad (6.16)$$

By periodic, we mean that $\phi(\cdot + l) = \phi$ in \mathbb{R} . In the sequel we say that 0 is an unstable steady state of (6.12)–(6.13) if $\lambda_1 < 0$, otherwise the state 0 is said to be stable (i.e., $\lambda_1 \geq 0$). These definitions will be seen to be natural in view of the results we prove here. By applying (6.16) at minimal and maximal points of the positive continuous periodic function ϕ , whether these points be in patches or on the interfaces, it easily follows that

$$-f'_1(0) \leq \lambda_1 \leq -f'_2(0)$$

(remember that $f'_1(0) \geq f'_2(0)$ without loss of generality). In particular, if $\lambda_1 < 0$, then $f'_1(0) > 0$, that is, $f_s(x, 0)$ is necessarily positive (at least) in the favorable patches.

6. Propagation phenomena in periodic patchy landscapes with interface conditions

We first state a criterion for the existence of a continuous solution $p : \mathbb{R} \rightarrow \mathbb{R}$ (such that $p|_{\bar{I}} \in C^2(\bar{I})$ for each patch I) to the elliptic problem:

$$\begin{cases} -d(x)p''(x) - f(x, p(x)) = 0, & x \in \mathbb{R} \setminus S, \\ p(x^-) = p(x^+), \quad p'(x^-) = \sigma p'(x^+), & x \in S_1, \\ p(x^-) = p(x^+), \quad \sigma p'(x^-) = p'(x^+), & x \in S_2. \end{cases} \quad (6.17)$$

Theorem 6.3. (i) Assume that 0 is an unstable solution of (6.17) (i.e., $\lambda_1 < 0$) and that f satisfies (6.14). Then there exists a bounded positive and periodic solution p of (6.17).

(ii) Assume that 0 is a stable solution of (6.17) (i.e., $\lambda_1 \geq 0$) and that f satisfies (6.14)–(6.15). Then 0 is the only nonnegative bounded solution of (6.17).

For reaction-diffusion equations that describe population dynamics in general periodically fragmented landscapes but do not include movement behavior at interfaces, the criteria for existence (and uniqueness) of the stationary problem in arbitrary dimension can be found in [24]. It turns out that the approach there can be adapted to our periodic patch model with the additional nonstandard interface conditions.

Let us now provide an insight into the stability of the trivial solution of (6.17). Under certain reasonable hypotheses on the diffusivities, the sizes of favorable and unfavorable patches, as well as the nonlinearities, the principal eigenvalue λ_1 of (6.16) can indeed be negative. For example, when all patches support population growth, namely $f'_1(0) > 0$ and $f'_2(0) > 0$, then the zero state is unstable. When the landscape consists of source and sink patches, i.e., when $f'_1(0) > 0 > f'_2(0)$, the stability of the zero state depends on the relationships between patch size, patch preference, diffusivity and growth rates. In the case $k = 1$, Shigesada and coworkers derived such a stability criterion [146]; the case for general $\sigma > 0$ can be found in [121]. We here derive an even more general formula, when we only assume that $f'_2(0) \leq f'_1(0)$. To do so, we first observe that the continuous functions $x \mapsto \phi(-l_1 - x)$ and $x \mapsto \phi(l_2 - x)$ still solve (6.16) as ϕ does, and by uniqueness we get that $\phi(-l_1 - x) = \phi(l_2 - x) = \phi(x)$ for all $x \in \mathbb{R}$, hence $\phi'(-l_1/2) = \phi'(l_2/2) = 0$. Then, as in [121, 146], by solving (6.16) in $[-l_1/2, 0]$ and in $[0, l_2/2]$ with zero derivatives at $-l_1/2$ and $l_2/2$, and by matching the interface conditions at 0, we find that λ_1 is the smallest root in $[-f'_1(0), -f'_2(0)]$ of the equation:

$$\sqrt{\frac{f'_1(0) + \lambda_1}{d_1}} \tan\left(\sqrt{\frac{f'_1(0) + \lambda_1}{d_1}} \times \frac{l_1}{2}\right) = \sigma \sqrt{-\frac{\lambda_1 + f'_2(0)}{d_2}} \tanh\left(\sqrt{-\frac{\lambda_1 + f'_2(0)}{d_2}} \times \frac{l_2}{2}\right). \quad (6.18)$$

When $0 < f'_2(0) \leq f'_1(0)$ or when $0 = f'_2(0) < f'_1(0)$ (irrespective of the other parameters), then the trivial solution of (6.17) is unstable (i.e., $\lambda_1 < 0$). When $f'_2(0) \leq f'_1(0) \leq 0$, then $\lambda_1 \geq 0$. When $f'_2(0) < 0 < f'_1(0)$, we then derive that the trivial solution of (6.17) is stable

($\lambda_1 \geq 0$) if

$$l_1 \leq l_1^c := 2\sqrt{\frac{d_1}{f_1'(0)}} \tan^{-1} \left(\sigma \sqrt{\frac{-d_1 f_2'(0)}{d_2 f_1'(0)}} \tanh \left(\sqrt{\frac{-f_2'(0)}{d_2}} \times \frac{l_2}{2} \right) \right) \quad (6.19)$$

(notice that $l_1^c > 0$), and unstable ($\lambda_1 < 0$) if $l_1 > l_1^c$. The persistence threshold l_1^c is decreasing with $f_1'(0) > 0$ and increasing with d_1 and l_2 . Passing to the limit $l_2 \rightarrow +\infty$, we find that

$$l_1^c \rightarrow L_1^c := 2\sqrt{\frac{d_1}{f_1'(0)}} \tan^{-1} \left(\sigma \sqrt{\frac{-d_1 f_2'(0)}{d_2 f_1'(0)}} \right).$$

Therefore, as long as $l_1 > L_1^c$, the trivial solution of (6.17) is unstable (i.e., $\lambda_1 < 0$), no matter how large the size of the unfavorable patches is. Similarly, there is a critical rate

$$(f_2'(0))^c = -\frac{d_2 f_1'(0)}{\sigma^2 d_1} \left[\tan \left(\sqrt{\frac{f_1'(0)}{d_1}} \times \frac{l_1}{2} \right) \right]^2$$

such that, if $0 > f_2'(0) > (f_2'(0))^c$, then the trivial solution of (6.17) is unstable (i.e., $\lambda_1 < 0$), no matter how large the size of the unfavorable patch is.

It also follows from (6.18) that, provided $f_2'(0) \neq f_1'(0)$, the principal eigenvalue λ_1 is increasing with respect to $\sigma > 0$, that is, λ_1 is decreasing with respect to $\alpha \in (0, 1)$. When $\alpha \in (0, 1)$ increases, then the individuals at the interfaces have more propensity to go to patches of type 1 rather than to patches of type 2. This means that the relative advantage of the more favorable patches becomes more prominent: λ_1 decreases and the 0 solution has more chances to become unstable. It is also easy to see that $\lambda_1 \rightarrow -f_1'(0)$ as $\sigma \rightarrow 0^+$ (that is, as $\alpha \rightarrow 1^-$), hence 0 is unstable if $\alpha \approx 1$, provided the patches of type 1 support population growth. On the other hand, $\lambda_1 \rightarrow \min(d_1 \pi^2 / l_1^2 - f_1'(0), -f_2'(0))$ as $\sigma \rightarrow +\infty$ (that is, as $\alpha \rightarrow 0^+$). Therefore, if $f_1'(0) \geq d_1 \pi^2 / l_1^2$, and even if $f_2'(0) < 0$, then 0 is still unstable when α is small (and actually whatever the value of $\alpha \in (0, 1)$ and the other parameters may be).

Next, we state a Liouville type result for problem (6.17).

Theorem 6.4. *Assume that f satisfies (6.14)–(6.15) and that the zero solution of (6.17) is unstable (i.e., $\lambda_1 < 0$). Then there exists at most one positive and bounded solution p of (6.17). Furthermore, such a solution p , if any, is periodic and $\inf_{\mathbb{R}} p = \min_{\mathbb{R}} p > 0$.*

Under the assumptions of Theorem 6.3 (i) and Theorem 6.4, we now look at the global attractiveness of the unique positive and bounded stationary solution p of (6.17) for the solutions of the Cauchy problem (6.12)–(6.13).

Theorem 6.5. *Assume that f satisfies (6.14)–(6.15). Let u be the solution of the Cauchy problem (6.12)–(6.13) with a nonnegative bounded and continuous initial datum $u_0 \not\equiv 0$.*

6. Propagation phenomena in periodic patchy landscapes with interface conditions

(i) If 0 is an unstable solution of (6.17) (i.e., $\lambda_1 < 0$), then $u(t, \cdot)|_{\bar{I}} \rightarrow p|_{\bar{I}}$ in $C^2(\bar{I})$ as $t \rightarrow +\infty$ for each patch I , where p is the unique positive bounded and periodic solution of (6.17) given by Theorem 6.3 (i) and Theorem 6.4.²

(ii) If 0 is a stable solution of (6.17) (i.e., $\lambda_1 \geq 0$), then $u(t, \cdot) \rightarrow 0$ uniformly in \mathbb{R} as $t \rightarrow +\infty$.

6.2.4 Spreading speeds and pulsating traveling waves

In this subsection, we assume that the zero solution of (6.17) is unstable (i.e., $\lambda_1 < 0$) and that f satisfies (6.14)–(6.15). Let p be the unique positive bounded and periodic solution of (6.17) obtained from Theorem 6.3 (i) and Theorem 6.4. After showing in Theorem 6.5 (i) the attractiveness of p , we now want to describe the way the positive steady state p invades the whole domain.

Let \mathcal{C} be the space of all bounded and uniformly continuous functions from \mathbb{R} to \mathbb{R} equipped with the compact open topology, i.e., we say that $u_n \rightarrow u$ as $n \rightarrow +\infty$ in \mathcal{C} when $u_n \rightarrow u$ locally uniformly in \mathbb{R} . For $u, v \in \mathcal{C}$, we write $u \geq v$ when $u(x) \geq v(x)$ for all $x \in \mathbb{R}$, $u > v$ when $u \geq v$ and $u \not\equiv v$, and $u \gg v$ when $u(x) > v(x)$ for all $x \in \mathbb{R}$. Notice that $p \in \mathcal{C}$ is periodic and satisfies $p \gg 0$. We define

$$\mathcal{C}_p = \{v \in \mathcal{C} : 0 \leq v \leq p\}. \quad (6.20)$$

Let \mathbb{P} be the set of all continuous and periodic functions from \mathbb{R} to \mathbb{R} equipped with the L^∞ -norm, and $\mathbb{P}^+ = \{u \in \mathbb{P} : u \geq 0\}$.

The first result of this section states the existence of a speed of invasion by the state p .

Theorem 6.6. *Assume that f satisfies (6.14)–(6.15) and that the zero solution of (6.17) is unstable (i.e., $\lambda_1 < 0$). Then there is an asymptotic spreading speed, $c^* > 0$, given explicitly by*

$$c^* = \inf_{\mu > 0} \frac{-\lambda(\mu)}{\mu},$$

where $\lambda(\mu)$ is the principal eigenvalue of the operator

$$\mathcal{L}_\mu \psi(x) := -d(x)\psi''(x) + 2\mu d(x)\psi'(x) - (d(x)\mu^2 + f_s(x, 0))\psi(x) \text{ for } x \in \mathbb{R} \setminus S,$$

²This statement shows that the solution u converges as $t \rightarrow +\infty$ locally uniformly in space to the space-periodic function p . For a convergence result to time-periodic solutions for time-periodic quasilinear parabolic equations, we refer to [46].

acting on the set

$$E_\mu = \{ \psi \in C(\mathbb{R}) : \psi|_{\bar{I}} \in C^2(\bar{I}) \text{ for each patch } I, \psi \text{ is periodic in } \mathbb{R}, \\ [-\mu\psi + \psi'](x^-) = \sigma[-\mu\psi + \psi'](x^+) \text{ for } x \in S_1, \\ \sigma[-\mu\psi + \psi'](x^-) = [-\mu\psi + \psi'](x^+) \text{ for } x \in S_2 \},$$

such that the following statements are valid:

- (i) if u is the solution to problem (6.12)–(6.13) with a compactly supported initial condition $u_0 \in \mathcal{C}_p$, then $\lim_{t \rightarrow +\infty} \sup_{|x| \geq ct} u(t, x) = 0$ for every $c > c^*$;
- (ii) if $u_0 \in \mathcal{C}_p$ with $u_0 \not\equiv 0$, then $\lim_{t \rightarrow +\infty} \max_{|x| \leq ct} |u(t, x) - p(x)| = 0$ for every $0 \leq c < c^*$.

It finally turns out that the asymptotic spreading speed c^* is also related to some speeds of rightward or leftward periodic (also called pulsating) traveling waves, whose definition is recalled:

Definition 6.7. A bounded continuous solution $u : \mathbb{R} \times \mathbb{R} \rightarrow \mathbb{R}$ of problem (6.12)–(6.13) is called a periodic rightward traveling wave connecting $p(x)$ to 0 if it has the form $u(t, x) = W(x - ct, x)$, where $c \in \mathbb{R}$ and the function $W : \mathbb{R} \times \mathbb{R} \rightarrow \mathbb{R}$ has the properties: for each $s \in \mathbb{R}$ the map $x \mapsto W(x + s, x)$ is continuous³ and the map $x \mapsto W(s, x)$ is periodic, and for each $x \in \mathbb{R}$ the map $s \mapsto W(s, x)$ is decreasing with $W(-\infty, x) = p(x)$ and $W(+\infty, x) = 0$.

Similarly, a bounded continuous solution $u : \mathbb{R} \times \mathbb{R} \rightarrow \mathbb{R}$ of problem (6.12)–(6.13) is called a periodic leftward traveling wave connecting 0 to $p(x)$ if it has the form $u(t, x) = W(x + ct, x)$, where $c \in \mathbb{R}$ and the function $W : \mathbb{R} \times \mathbb{R} \rightarrow \mathbb{R}$ has the properties: for each $s \in \mathbb{R}$ the map $x \mapsto W(x + s, x)$ is continuous and the map $x \mapsto W(s, x)$ is periodic, and for each $x \in \mathbb{R}$ the map $s \mapsto W(s, x)$ is increasing with $W(-\infty, x) = 0$ and $W(+\infty, x) = p(x)$.

The following result shows that the asymptotic spreading speed c^* given in Theorem 6.6 coincides with minimal speeds of periodic traveling waves in the positive and negative directions.

Theorem 6.8. Assume that the zero solution of (6.17) is unstable (i.e., $\lambda_1 < 0$) and that f satisfies (6.14)–(6.15). Let c^* be the asymptotic spreading speed given in Theorem 6.6. Then the following statements are valid:

- (i) problem (6.12)–(6.13) has a periodic rightward traveling wave $W(x - ct, x)$ connecting $p(x)$ to 0, in the sense of Definition 6.7, if and only if $c \geq c^*$;
- (ii) problem (6.12)–(6.13) has a periodic leftward traveling wave $W(x + ct, x)$ connecting 0 to $p(x)$, in the sense of Definition 6.7, if and only if $c \geq c^*$.

³Notice that the continuity of $x \mapsto W(x + s, x)$ is automatic if $c \neq 0$, since u is assumed to be continuous itself in $\mathbb{R} \times \mathbb{R}$.

Remark 6.9. It is known that for the standard spatially periodic Fisher-KPP problem (6.2) with $N = 1$, the variational characterization of minimal speeds in terms of a family of principal eigenvalues implies that the minimal wave speeds of rightward and leftward pulsating waves are the same. Theorem 6.8 shows that this property still holds true for our one-dimensional patchy periodic habitat, with nonstandard movement behavior at interfaces.

Outline of the chapter. The rest of the chapter is organized as follows. In the next section, we give the proof of Theorem 6.2 on the well-posedness of the Cauchy problem (6.12)–(6.13). Section 6.4 is devoted to the study of the stationary problem (6.17) and we give the proofs of Theorems 6.3 and 6.4. In Section 6.5, we prove Theorem 6.5 on the large-time behavior of the evolution problem. Finally, Section 6.6 is devoted to the proofs of Theorems 6.6 and 6.8, based on the abstract monotone semiflow method developed in [113, 114, 155]. Lastly, the appendix is devoted to giving supplementary comparison results concerning finitely many patches, which play an essential role in the well-posedness argument in Section 6.3.

6.3 Well-posedness of the Cauchy problem (6.12)–(6.13): proof of Theorem 6.2

In this section, we establish the well-posedness of the Cauchy problem (6.12)–(6.13) with nonnegative, bounded and continuous initial data. We first show the existence of classical solutions based on a semigroup argument and an approximation approach. Then we prove that the solutions depend monotonically and continuously on the initial data.

6.3.1 Truncated problem

Fix $n \in \mathbb{N}$. We consider the following truncated problem of (6.12)–(6.13) in the finite interval $[-nl, nl]$, which consists of $4n$ disjoint patches (see Figure 2):

$$\begin{cases} \frac{\partial u_{1m}}{\partial t} = d_1 \frac{\partial^2 u_{1m}}{\partial x^2} + f_1(u_{1m}), & t > 0, \quad x \in (ml - l_1, ml), \quad m = 0, \pm 1, \dots, \pm(n-1), n, \\ \frac{\partial u_{2m}}{\partial t} = d_2 \frac{\partial^2 u_{2m}}{\partial x^2} + f_2(u_{2m}), & t > 0, \quad x \in (ml, ml + l_2), \quad m = 0, \pm 1, \dots, \pm(n-1), -n, \end{cases} \quad (6.21)$$

together with interface conditions

$$\begin{cases} u_{1m}(t, x^-) = u_{2m}(t, x^+), \quad (u_{1m})_x(t, x^-) = \sigma(u_{2m})_x(t, x^+), \\ \qquad \qquad \qquad t > 0, \quad x = ml, \quad m = 0, \pm 1, \dots, \pm(n-1), \\ u_{2m}(t, x^-) = u_{1(m+1)}(t, x^+), \quad \sigma(u_{2m})_x(t, x^-) = (u_{1(m+1)})_x(t, x^+), \\ \qquad \qquad \qquad t > 0, \quad x = ml + l_2, \quad m = 0, \pm 1, \dots, \pm(n-1), -n, \end{cases} \quad (6.22)$$

6.3. Well-posedness of the Cauchy problem (6.12)–(6.13): proof of Theorem 6.2

and boundary conditions at $x = \pm nl$:

$$u_{1n}(t, (-nl)^+) = u_{2(-n)}(t, (nl)^-) = 0, \quad t > 0. \quad (6.23)$$

For consistency of notations, we set

$$\begin{cases} I_{1m} = (ml - l_1, ml) & \text{for } m \in J_1 = \{0, \pm 1, \dots, \pm(n-1), n\}, \\ I_{2m} = (ml, ml + l_2) & \text{for } m \in J_2 = \{0, \pm 1, \dots, \pm(n-1), -n\}. \end{cases}$$

We number these $4n$ patches from left to right by $I_{2(-n)}, I_{1(-n+1)}, \dots, I_{10}, I_{20}, \dots, I_{2(n-1)}, I_{1n}$, so that

$$[-nl, nl] = \left(\bigcup_{j \in J_1} \overline{I_{1j}} \right) \cup \left(\bigcup_{j \in J_2} \overline{I_{2j}} \right).$$

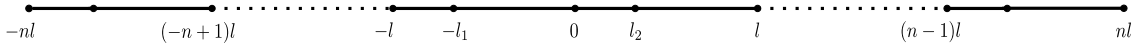

Figure 18: Truncated interval $[-nl, nl]$.

For a solution $(u_{2(-n)}, \dots, u_{1n})$ of (6.21)–(6.23), we define $u : (0, +\infty) \times [-nl, nl] \rightarrow \mathbb{R}$ such that, for $t > 0$,

$$\begin{cases} u(t, x) = u_{1j}(t, x) & \text{if } x \in I_{1j} \text{ with } j \in J_1, \\ u(t, x) = u_{2j}(t, x) & \text{if } x \in I_{2j} \text{ with } j \in J_2, \\ u(t, \cdot) & \text{is extended by continuity at the interior interfaces and by 0 at } \pm nl. \end{cases} \quad (6.24)$$

We finally set

$$\mathcal{C}_0 = \{\varphi \in C([-nl, nl]) : \varphi(-nl) = \varphi(nl) = 0\}, \quad (6.25)$$

equipped with the sup norm.

Definition 6.10. For $T \in (0, +\infty]$, we say that a continuous function $u : [0, T] \times [-nl, nl] \rightarrow \mathbb{R}$ is a classical solution to the truncated problem (6.21)–(6.24) in $[0, T] \times [-nl, nl]$ with an initial condition $u_0 \in \mathcal{C}_0$, if $u(0, \cdot) = u_0$, if $u|_{(0, T) \times \bar{I}} \in C_{t;x}^{1;2}((0, T) \times \bar{I})$ for each patch $I \subset [-nl, nl]$, and if all identities in (6.21)–(6.24) are satisfied pointwise for $0 < t < T$.

Theorem 6.11. Under the assumption (6.14), the Cauchy problem (6.21)–(6.24) with a nonnegative initial condition $u_0 \in \mathcal{C}_0$ admits a unique bounded classical solution $u : [0, +\infty) \times [-nl, nl] \rightarrow \mathbb{R}$. Furthermore,

$$0 \leq u \leq \max(K_1, K_2, \|u_0\|_{L^\infty(-nl, nl)}) \quad \text{in } [0, +\infty) \times [-nl, nl]. \quad (6.26)$$

6. Propagation phenomena in periodic patchy landscapes with interface conditions

If $0 \leq u_0 \leq v_0$ in $[-nl, nl]$ with u_0, v_0 in \mathcal{C}_0 , then the solutions u and v with respective initial conditions u_0 and v_0 satisfy $u \leq v$ in $[0, +\infty) \times [-nl, nl]$.

The uniqueness and comparison properties immediately follow from Proposition 6.23 in the appendix. In what follows, we prove the existence of a bounded classical solution to (6.21)–(6.24), relying on semigroup theory. To do so, we first introduce some auxiliary spaces and recast the truncated Cauchy problem into the abstract form:

$$\begin{cases} \frac{dU}{dt} + AU = f(U), & t > 0, \\ U(0) = U_0, \end{cases} \quad (6.27)$$

where $U = (u_{2(-n)}, \dots, u_{1n})^T$, $U_0 = (u_0|_{(-nl, -nl+l_2)}, \dots, u_0|_{(nl-l_1, nl)})^T$, and A and $f(U)$ are defined by

$$A = \begin{pmatrix} -d_2 \partial_{xx} & & & & & \\ & -d_1 \partial_{xx} & & & & \\ & & \ddots & & & \\ & & & -d_2 \partial_{xx} & & \\ & & & & -d_1 \partial_{xx} & \\ & & & & & \end{pmatrix}_{4n \times 4n} \quad \text{and} \quad f(U) = \begin{pmatrix} f_2(u_{2(-n)}) \\ f_1(u_{1(-n+1)}) \\ \vdots \\ f_2(u_{2(n-1)}) \\ f_1(u_{1n}) \end{pmatrix}. \quad (6.28)$$

Set

$$X = L^2(I_{2(-n)}) \times \dots \times L^2(I_{1n}),$$

with elements viewed as column vectors. With a slight abuse of notation, X can be identified with $L^2(-nl, nl)$. We then define an inner product in X as follows:

$$\langle U, V \rangle_X = \sum_{j \in J_1} \int_{I_{1j}} u_{1j} v_{1j} + \frac{1}{k} \sum_{j \in J_2} \int_{I_{2j}} u_{2j} v_{2j}, \quad (6.29)$$

which induces the norm $U \mapsto \|U\|_X = \sqrt{\langle U, U \rangle_X}$ and makes X a Hilbert space.⁴ We also introduce other Hilbert spaces

$$\begin{cases} \mathcal{H}^1 = \{(u_{2(-n)}, \dots, u_{1n})^T \in H^1(I_{2(-n)}) \times \dots \times H^1(I_{1n}), \\ \quad u_{1m}(x) = u_{2m}(x), \quad x = ml, \quad m = 0, \pm 1, \dots, \pm(n-1), \\ \quad u_{2m}(x) = u_{1(m+1)}(x), \quad x = ml + l_2, \quad m = 0, \pm 1, \dots, \pm(n-1), -n\}, \\ \mathcal{H}_0^1 = \{(u_{2(-n)}, \dots, u_{10}, u_{20}, \dots, u_{1n})^T \in \mathcal{H}^1 : u_{2(-n)}(-nl) = u_{1n}(nl) = 0\}, \end{cases}$$

⁴We recall that $k > 0$ is given in (6.6). In all integrals, we integrate with respect to the one-dimensional Lebesgue measure.

with elements viewed as column vectors, equipped with the norm

$$\|U\|_{\mathcal{H}^1} = \|U\|_{\mathcal{H}_0^1} = \sqrt{\sum_{j \in J_1} \|u_{1j}\|_{H^1(I_{1j})}^2 + \frac{1}{k} \sum_{j \in J_2} \|u_{2j}\|_{H^1(I_{2j})}^2}.$$

From the Sobolev embeddings and with a slight abuse of notation, \mathcal{H}^1 and \mathcal{H}_0^1 can be identified with $H^1(-nl, nl)$ and $H_0^1(-nl, nl)$, respectively, and viewed as subsets of $C([-nl, nl])$ and \mathcal{C}_0 , respectively, with definition (6.25). Furthermore, in \mathcal{H}_0^1 the norms $\|U\|_{\mathcal{H}_0^1}$ and $\|U'\|_X$ are equivalent, from Poincaré's inequality. We finally define the Hilbert space

$$\mathcal{H}^2 = H^2(I_{2(-n)}) \times \cdots \times H^2(I_{1n}),$$

with elements viewed as column vectors, equipped with the norm

$$\|U\|_{\mathcal{H}^2} = \sqrt{\sum_{j \in J_1} \|u_{1j}\|_{H^2(I_{1j})}^2 + \frac{1}{k} \sum_{j \in J_2} \|u_{2j}\|_{H^2(I_{2j})}^2},$$

and the subspace

$$\mathcal{D}(A) = \left\{ (u_{2(-n)}, \dots, u_{1n})^T \in \mathcal{H}^2 \cap \mathcal{H}_0^1 : \begin{aligned} (u_{1m})'(x) &= \sigma(u_{2m})'(x), & x = ml, & m = 0, \pm 1, \dots, \pm(n-1), \\ \sigma(u_{2m})'(x) &= (u_{1(m+1)})'(x), & x = ml + l_2, & m = 0, \pm 1, \dots, \pm(n-1), -n \end{aligned} \right\}. \quad (6.30)$$

From the Sobolev embeddings, the set \mathcal{H}^2 can be viewed as a subset of $C^1(\overline{I_{2(-n)}}) \times \cdots \times C^1(\overline{I_{1n}})$ and, with a slight abuse of notation, it can also be identified with the set of φ in $L^2(-nl, nl)$ such that $\varphi|_I \in H^2(I)$ for each patch $I \subset [-nl, nl]$. As for $\mathcal{D}(A)$, one has $\mathcal{D}(A) \subset \mathcal{H}^2 \cap \mathcal{H}_0^1 \subset X$ and, from the Sobolev embeddings, $\mathcal{D}(A)$ is a Banach space when endowed with the norm $\|\cdot\|_{\mathcal{H}^2}$. With a slight abuse of notation, $\mathcal{D}(A)$ can also be identified with the set of φ in $H_0^1(-nl, nl)$ such that $\varphi|_I \in H^2(I)$ for each patch $I \subset [-nl, nl]$ and φ satisfies the above flux conditions at the interior interfaces.

The proof of the well-posedness of the Cauchy problem (6.21)–(6.24) is based on the following auxiliary lemma.

Lemma 6.12. *The linear operator $A : \mathcal{D}(A) \subset X \rightarrow X$ is symmetric maximal monotone, and $-A$ is the infinitesimal generator of an analytic semigroup on X .*

Proof. For any $U = (u_{2(-n)}, \dots, u_{1n})^T \in \mathcal{D}(A)$, by using (6.11) and the interface and bound-

6. Propagation phenomena in periodic patchy landscapes with interface conditions

any conditions given in the definition of $\mathcal{D}(A)$, we have

$$\begin{aligned} \langle AU, U \rangle_X &= \sum_{j \in J_1} \int_{I_{1j}} (-d_1 u''_{1j}) u_{1j} + \frac{1}{k} \sum_{j \in J_2} \int_{I_{2j}} (-d_2 u''_{2j}) u_{2j} \\ &= \sum_{j \in J_1} \int_{I_{1j}} d_1 u'_{1j} u'_{1j} + \frac{1}{k} \sum_{j \in J_2} \int_{I_{2j}} d_2 u'_{2j} u'_{2j} \geq \beta \|U\|_{\mathcal{H}_0^1}^2 \geq 0, \end{aligned} \quad (6.31)$$

where $\beta > 0$ is a positive constant independent of $U \in \mathcal{D}(A) \subset \mathcal{H}_0^1$, given by Poincaré's inequality. Therefore, A is monotone. The symmetry of A is also obvious from a similar calculation.

Next, we shall prove that, for every $\lambda \geq 0$, the range $\mathcal{R}(\lambda I_X + A)$ of $\lambda I_X + A$ is equal to X (I_X denotes the identity operator in X), that is, for any $F \in X$, there exists $U \in \mathcal{D}(A)$ such that $\lambda U + AU = F$ (such a U is then unique from (6.31)). For any $F = (f_{2(-n)}, \dots, f_{1n})^T \in X$, we consider the following boundary value problem:

$$\begin{cases} -d_2 u''_{2(-n)} + \lambda u_{2(-n)} = f_{2(-n)}, & \text{in } (-nl, -nl + l_2), \\ -d_1 u''_{1m} + \lambda u_{1m} = f_{1m}, & \text{in } (ml - l_1, ml), \quad m = 0, \pm 1, \dots, \pm(n-1), \\ -d_2 u''_{2m} + \lambda u_{2m} = f_{2m}, & \text{in } (ml, ml + l_2), \quad m = 0, \pm 1, \dots, \pm(n-1), \\ -d_1 u''_{1n} + \lambda u_{1n} = f_{1n}, & \text{in } (nl - l_1, nl), \end{cases} \quad (6.32)$$

with interface conditions

$$\begin{cases} u_{1m}(x) = u_{2m}(x), & (u_{1m})'(x^-) = \sigma(u_{2m})'(x^+), \\ & x = ml, \quad m = 0, \pm 1, \dots, \pm(n-1), \\ u_{2m}(x) = u_{1(m+1)}(x), & \sigma(u_{2m})'(x^-) = (u_{1(m+1)})'(x^+), \\ & x = ml + l_2, \quad m = 0, \pm 1, \dots, \pm(n-1), -n, \end{cases} \quad (6.33)$$

and boundary conditions

$$u_{2(-n)}(-nl) = u_{1n}(nl) = 0. \quad (6.34)$$

Problem (6.32)–(6.34) is first converted into a weak problem, which consists in finding $U \in \mathcal{H}_0^1$ such that

$$a(U, V) = \langle F, V \rangle_X \quad \text{for all } V \in \mathcal{H}_0^1, \quad (6.35)$$

where the bilinear form a is defined in $\mathcal{H}_0^1 \times \mathcal{H}_0^1$ by

$$a(U, V) = \sum_{j \in J_1} \int_{I_{1j}} (d_1 u'_{1j} v'_{1j} + \lambda u_{1j} v_{1j}) + \frac{1}{k} \sum_{j \in J_2} \int_{I_{2j}} (d_2 u'_{2j} v'_{2j} + \lambda u_{2j} v_{2j}).$$

It is clear that the bilinear form defined in $\mathcal{H}_0^1 \times \mathcal{H}_0^1$ is continuous and coercive (from Poincaré's

inequality again). Then, by the Lax-Milgram theorem, problem (6.35) admits a unique solution $U \in \mathcal{H}_0^1$, and we have

$$\|U\|_{\mathcal{H}_0^1} \leq C\|F\|_X, \quad (6.36)$$

for some constant $C > 0$ only depending on $d_{1,2}$, k , n and $l_{1,2}$. Furthermore, owing to the definition of a , the solution U belongs to $\mathcal{D}(A)$ and satisfies (6.32)–(6.34). By rewriting the equations as $u''_{ij} = (\lambda u_{ij} - f_{ij})/d_i$ for $j \in J_i$ and $i \in \{1, 2\}$, and taking L^2 -norms on both sides, we get $\|u''_{ij}\|_{L^2(I_{ij})} \leq (1/d_i) \times (\lambda \|u_{ij}\|_{L^2(I_{ij})} + \|f_{ij}\|_{L^2(I_{ij})})$. By (6.36), we finally obtain the overall H^2 estimate $\|U\|_{\mathcal{H}^2} \leq C'\|F\|_X$ for some constant $C' > 0$ only depending on $d_{1,2}$, k , n , $l_{1,2}$ and λ . We then conclude that $\mathcal{R}(\lambda I_X + A) = X$, that $\lambda I_X + A$ is invertible from $\mathcal{D}(A)$ onto X and that $(\lambda I_X + A)^{-1}$ is bounded from X onto $\mathcal{D}(A)$. In particular, $\mathcal{R}(I_X + A) = X$ and the operator A is maximal monotone. It is then densely defined and closed, and $\mathcal{D}(A)$ is also a Banach space if endowed with the graph norm $\|U\|_{\mathcal{D}(A)}$ of A .

Lastly, let us show that $-A$ is the infinitesimal generator of an analytic semigroup on X . First of all, since A is monotone, one has $\lambda\|u\|_X \leq \|(\lambda I_X + A)u\|_X$ for every $\lambda \geq 0$ and $u \in \mathcal{D}(A)$, hence

$$\|(\lambda I_X + A)^{-1}\|_{\mathcal{L}(X)} \leq \frac{1}{\lambda} \text{ for every } \lambda > 0.$$

Therefore, the Hille-Yosida theorem implies that the operator $-A$ is the infinitesimal generator of a contraction semigroup on X . On the other hand, by viewing A in the complexified Hilbert spaces associated with X and \mathcal{H}^2 , one sees from (6.31) and the symmetry of A that the numerical range $\mathcal{S}(-A)$ of $-A$ is included in \mathbb{R} and more precisely in an interval $(-\infty, -\delta]$, for some $\delta > 0$. Fix any $\theta \in (0, \pi/2)$ and denote

$$\Sigma_\theta := \{\lambda \in \mathbb{C}^* : |\arg \lambda| < \pi - \theta\}.$$

Then there is $C_\theta > 0$ such that $\text{dist}(\lambda, \overline{\mathcal{S}(-A)}) \geq C_\theta|\lambda|$ for all $\lambda \in \Sigma_\theta$, where $\text{dist}(\lambda, \overline{\mathcal{S}(-A)})$ represents the distance in \mathbb{C} between λ and $\overline{\mathcal{S}(-A)}$. We observe that $\Sigma_\theta \cap \rho(-A) \neq \emptyset$, since any $\lambda > 0$ is in the resolvent set $\rho(-A)$ of $-A$ from the above analysis. Therefore, [138, Theorem 1.3.9] then states that $\Sigma_\theta \subset \rho(-A)$ and

$$\|(\lambda I_X + A)^{-1}\|_{\mathcal{L}(X)} \leq \frac{1}{C_\theta|\lambda|} \text{ for all } \lambda \in \Sigma_\theta.$$

Since 0 belongs to $\rho(-A)$ as well, we conclude by [138, Theorem 2.5.2] that $-A$ is the infinitesimal generator of an analytic semigroup on X . The proof of Lemma 6.12 is thereby complete. \square

With Lemma 6.12 in hand, we are now ready to prove Theorem 6.11 on the well-posedness of the Cauchy problem (6.21)–(6.24).

Proof of Theorem 6.11. The proof is divided into two main steps. The first one assumes an

6. Propagation phenomena in periodic patchy landscapes with interface conditions

additional hypothesis on the functions f_i in (6.14), and the second one deals with the general case of f_i satisfying (6.14).

Step 1: in addition to (6.14), assume that f_1 and f_2 are globally Lipschitz continuous from \mathbb{R} to \mathbb{R} . The function f given in (6.28) is then Lipschitz continuous from X to X . Therefore, it follows from Lemma 6.12 and [161, Theorem 2.5.1] that, for each $U_0 \in X$, problem (6.27) has a unique global mild solution $U \in C([0, +\infty), X)$, satisfying

$$U(t) = e^{-tA}U_0 + \int_0^t e^{-(t-s)A}f(U(s)) \, ds \quad (6.37)$$

for all $t \geq 0$. Note that the function $t \mapsto f(U(t))$ belongs to $C([0, +\infty), X)$ as well. By [119, Lemma 7.1.1], the integral on the right-hand side of (6.37) belongs to $C_{loc}^\gamma([0, +\infty), X)$ for any $\gamma \in (0, 1)$. Since $t \mapsto e^{-tA}U_0$ is of class $C^\infty((0, +\infty), \mathcal{D}(A))$ by [161, Theorem 2.3.2], we see that $U \in C_{loc}^\gamma((0, +\infty), X)$ for any $\gamma \in (0, 1)$ and that the function $t \mapsto f(U(t))$ belongs to $C_{loc}^\gamma((0, +\infty), X)$ too for any $\gamma \in (0, 1)$. It then follows from [119, Theorem 4.3.1] that $U \in C_{loc}^\gamma((0, +\infty), \mathcal{D}(A)) \cap C_{loc}^{1,\gamma}((0, +\infty), X)$ for any $\gamma \in (0, 1)$. As a consequence, U is a classical solution of (6.27), with equalities in X .

Furthermore, by Lemma 6.12 and the fact that $0 \in \rho(A)$, we can define fractional powers A^β of A . For $0 < \beta \leq 1$, A^β is a closed operator whose domain $\mathcal{D}(A^\beta)$ is dense in X and $\mathcal{D}(A) \hookrightarrow \mathcal{D}(A^\beta) \hookrightarrow X$ continuously. Endowed with the graph norm $\|U\|_{\mathcal{D}(A^\beta)}$ of A^β , $\mathcal{D}(A^\beta)$ is a Banach space. Since A is sectorial and $\inf\{\operatorname{Re}(\lambda) : \lambda \notin \rho(A)\} > 0$, it follows that A^β is invertible with bounded inverse $(A^\beta)^{-1} \in \mathcal{L}(X)$ and that the norm $\|U\|_{\mathcal{D}(A^\beta)}$ is equivalent to $\|A^\beta U\|_X$ in $\mathcal{D}(A^\beta)$. From [143, Lemma 37.8], one has, for each $1/4 < \beta \leq 1$ and $\delta \in (0, 2\beta - 1/2)$, a continuous embedding $\mathcal{D}(A^\beta) \hookrightarrow \mathcal{C}_0 \cap C^{0,\delta}([-nl, nl])$.⁵ From now on, we fix $\beta \in (1/4, 1)$. We also observe that $f : \mathcal{D}(A^\beta) \rightarrow X$ is globally Lipschitz continuous: indeed, for any $U, V \in \mathcal{D}(A^\beta)$, there holds

$$\begin{aligned} \|f(U) - f(V)\|_X &\leq L\|U - V\|_X = L\|(A^\beta)^{-1}A^\beta U - (A^\beta)^{-1}A^\beta V\|_X \\ &\leq L\|(A^\beta)^{-1}\|_{\mathcal{L}(X)}\|A^\beta U - A^\beta V\|_X \\ &\leq L\|(A^\beta)^{-1}\|_{\mathcal{L}(X)}\|U - V\|_{\mathcal{D}(A^\beta)}, \end{aligned}$$

for some constant $L \in [0, +\infty)$ independent of $U, V \in \mathcal{D}(A^\beta)$. Now, for any $U_0 \in \mathcal{D}(A^\beta) (\subset X)$, the unique global solution $U \in C([0, +\infty), X) \cap C_{loc}^\gamma((0, +\infty), \mathcal{D}(A)) \cap C_{loc}^{1,\gamma}((0, +\infty), X)$ (for any $\gamma \in (0, 1)$) of (6.27), given in the previous paragraph, also belongs to $C([0, +\infty), \mathcal{D}(A^\beta))$ and then to $C([0, +\infty), \mathcal{C}_0 \cap C^{0,\delta}([-nl, nl]))$ for any $\delta \in (0, 2\beta - 1/2)$. Since U satisfies (6.37)

⁵With a slight abuse of notation, the embedding $\mathcal{D}(A^\beta) \hookrightarrow \mathcal{C}_0 \cap C^{0,\delta}([-nl, nl])$ means that the elements $U = (u_{2(-n)}, \dots, u_{1n})^T$ of $\mathcal{D}(A^\beta)$ have continuous components u_{ij} in each corresponding closed patch $\overline{I_{ij}}$, and that the function equal to each u_{ij} on each closed patch $\overline{I_{ij}}$ is well defined, continuous in $[-nl, nl]$, vanishes at $\pm nl$ and is Hölder continuous of exponent δ in $[-nl, nl]$, with a sup norm and a Hölder norm controlled by $\|U\|_{\mathcal{D}(A^\beta)}$.

6.3. Well-posedness of the Cauchy problem (6.12)–(6.13): proof of Theorem 6.2

for all $t \geq 0$, we then get by [101, Theorem 3.5.2] and [143, Lemma 37.8] the existence of some $\eta \in (0, 1)$, $\theta \in (1/4, 1)$ and $\omega \in (0, 2\theta - 1/2)$ such that $U \in C_{loc}^{1,\eta}((0, +\infty), \mathcal{D}(A^\theta))$ and

$$U \in C_{loc}^{1,\eta}((0, +\infty), \mathcal{C}_0 \cap C^{0,\omega}([-nl, nl])).$$

Since $\mathcal{D}(A) \leftrightarrow \mathcal{D}(A^\beta)$, it follows from the previous two paragraphs that, for any $U_0 \in X$, the solution $U \in C([0, +\infty), X) \cap C((0, +\infty), \mathcal{D}(A)) \cap C^1((0, +\infty), X)$ of (6.27) belongs to

$$C((0, +\infty), \mathcal{C}_0 \cap C^{0,\delta}([-nl, nl])) \cap C_{loc}^{1,\eta}((0, +\infty), \mathcal{C}_0 \cap C^{0,\omega}([-nl, nl])).$$

Moreover, if $U_0 \in \mathcal{D}(A^\beta)$, then $U \in C([0, +\infty), \mathcal{C}_0 \cap C^{0,\delta}([-nl, nl]))$. One infers that, for any $U_0 \in X$, the function u defined as in (6.24) (with similar definition at $t = 0$) is continuous in $(0, +\infty) \times [-nl, nl]$, vanishes on $(0, +\infty) \times \{\pm nl\}$, is of class C^1 with respect to t in $(0, +\infty) \times [-nl, nl]$, with u and $\frac{\partial u}{\partial t}$ Hölder continuous in $[\tau, \tau'] \times [-nl, nl]$ for every $0 < \tau < \tau' < +\infty$. Therefore, for each patch $I \subset [-nl, nl]$ of type $i \in \{1, 2\}$ and for each $0 < \tau < \tau' < +\infty$, the function $f_i(u)$ is Hölder continuous in $[\tau, \tau'] \times \bar{I}$, hence equation (6.27) implies that $u|_{[\tau, \tau'] \times \bar{I}}$ is of class C^2 with respect to x and $\frac{\partial^2 u|_{[\tau, \tau'] \times \bar{I}}}{\partial x^2}$ is Hölder continuous in $[\tau, \tau'] \times \bar{I}$. In particular, u is a classical solution of (6.21)–(6.24) for $t > 0$. Furthermore, if $U_0 \in \mathcal{D}(A^\beta)$, then u is also continuous in $[0, +\infty) \times [-nl, nl]$.

It remains to show, still in this step 1, that u is bounded and continuous up to $t = 0$ when $u_0 \in \mathcal{C}_0$. To do so, we first prove a comparison principle for the solutions when the initial conditions are in X . Take any $V_0, W_0 \in X$ such that $v_0 \leq w_0$ almost everywhere in $[-nl, nl]$, with obvious notations for v_0 and w_0 . There exist then two sequences $(V_{0j})_{j \in \mathbb{N}}$ and $(W_{0j})_{j \in \mathbb{N}}$ in $\mathcal{D}(A) (\subset \mathcal{D}(A^\beta) \subset \mathcal{C}_0)$ such that $v_{0j} \leq w_{0j}$ everywhere in $[-nl, nl]$ (with obvious notations) for all $j \in \mathbb{N}$, and $V_{0j} \rightarrow V_0, W_{0j} \rightarrow W_0$ in X as $j \rightarrow +\infty$. For each $j \in \mathbb{N}$, with obvious notations, let v_j and w_j be the classical solutions of (6.21)–(6.24) with initial conditions v_{0j} and w_{0j} . The functions v_j and w_j are continuous in $[0, +\infty) \times [-nl, nl]$, from the previous paragraph. Therefore, the maximum principle of Proposition 6.23 implies that

$$v_j \leq w_j \text{ in } [0, +\infty) \times [-nl, nl],$$

for all $j \in \mathbb{N}$. Since, for each $t \geq 0$, the map $U_0 \mapsto U(t)$ given by (6.37) is continuous (and even Lipschitz continuous) from X to X by [161, Theorem 2.5.1], one infers that, for each $t > 0$, $v(t, \cdot) \leq w(t, \cdot)$ almost everywhere in $(-nl, nl)$ and then everywhere in $[-nl, nl]$ by continuity. To sum up,

$$v \leq w \text{ in } (0, +\infty) \times [-nl, nl]. \tag{6.38}$$

If $u_0 \in \mathcal{C}_0$ with $u_0 \geq 0$ in $[-nl, nl]$, without loss of generality, one can choose a sequence $(u_{0k})_{k \in \mathbb{N}}$ in $\mathcal{D}(A)$ such that $u_{0k} \rightarrow u_0$ as $k \rightarrow +\infty$ and $0 \leq u_{0k} \leq \|u_0\|_{L^\infty(-nl, nl)}$ in $[-nl, nl]$ for all $k \in \mathbb{N}$. Remembering (6.14), the constant functions 0 and $\max(K_1, K_2, \|u_0\|_{L^\infty(-nl, nl)})$

6. Propagation phenomena in periodic patchy landscapes with interface conditions

are, respectively, a subsolution and a supersolution, in the sense of Definition 6.22, of the problem (6.21)–(6.24) satisfied by the continuous and classical solution u_k in $[0, +\infty) \times [-nl, nl]$. The maximum principle of Proposition 6.23 then yields $0 \leq u_k \leq \max(K_1, K_2, \|u_0\|_{L^\infty(-nl, nl)})$ in $[0, +\infty) \times [-nl, nl]$ for all $k \in \mathbb{N}$, hence

$$0 \leq u \leq \max(K_1, K_2, \|u_0\|_{L^\infty(-nl, nl)}) \quad \text{in } (0, +\infty) \times [-nl, nl], \quad (6.39)$$

by passing to the limit as $k \rightarrow +\infty$ for each $t > 0$, as in the previous paragraph. Notice that (6.39) holds as well on $\{0\} \times [-nl, nl]$ by assumption on u_0 .

Lastly, consider again any $u_0 \in \mathcal{C}_0 (\subset X)$ in $[-nl, nl]$ and let us show that u is continuous up to time $t = 0$. Let $\varepsilon > 0$ be arbitrary. Let \underline{u}_0 and \bar{u}_0 be two functions in $\mathcal{D}(A) (\subset \mathcal{D}(A^\beta) \subset X)$ such that

$$u_0 - \varepsilon \leq \underline{u}_0 \leq u_0 \leq \bar{u}_0 \leq u_0 + \varepsilon \quad \text{in } [-nl, nl]$$

(with obvious notations for the functions \underline{u}_0 and \bar{u}_0 , which can be chosen in $C^2([-nl, nl]) \cap \mathcal{C}_0$ with zero derivatives at the interior interfaces) and let \underline{u} and \bar{u} be the two classical solutions of (6.21)–(6.24) with initial conditions \underline{u}_0 and \bar{u}_0 . From the above arguments, the functions \underline{u} and \bar{u} are continuous in $[0, +\infty) \times [-nl, nl]$, and $\underline{u} \leq u \leq \bar{u}$ in $[0, +\infty) \times [-nl, nl]$ from (6.38) and the choice of the initial conditions. Finally, there is $t_0 > 0$ such that

$$u_0 - 2\varepsilon \leq \underline{u}_0 - \varepsilon \leq \underline{u} \leq u \leq \bar{u} \leq \bar{u}_0 + \varepsilon \leq u_0 + 2\varepsilon \quad \text{in } [0, t_0] \times [-nl, nl],$$

from which it follows that the $C([0, +\infty) \times [-nl, nl])$ function u is also continuous up to time $t = 0$. It is therefore a bounded classical solution of (6.21)–(6.24) in $[0, +\infty) \times [-nl, nl]$ with initial condition u_0 , in the sense of Definition 6.10.

Step 2: the general case of assumption (6.14). Consider a nonnegative initial condition u_0 in \mathcal{C}_0 . Denote $K = \max(K_1, K_2, \|u_0\|_{L^\infty(-nl, nl)})$ and, for $i = 1, 2$, let $\tilde{f}_i : \mathbb{R} \rightarrow \mathbb{R}$ be a globally Lipschitz continuous function of class $C^1(\mathbb{R})$ such that $\tilde{f}_i|_{[0, K]} = f_i|_{[0, K]}$ and $\tilde{f}_i \leq 0$ in $[K_i, +\infty)$. From Step 1, there is a unique bounded classical solution u of (6.21)–(6.24) in $[0, +\infty) \times [-nl, nl]$ with initial condition u_0 , but with the nonlinearities \tilde{f}_i instead of f_i , and u satisfies (6.39) in $[0, +\infty) \times [-nl, nl]$. From (6.39) and the choice of \tilde{f}_i , the function u is then a bounded classical solution of the problem (6.21)–(6.24) in $[0, +\infty) \times [-nl, nl]$ with initial condition u_0 and with the original nonlinearities f_i .

Since the uniqueness and comparison properties in Theorem 6.11 directly follow from Proposition 6.23, the proof of Theorem 6.11 is thereby complete. \square

6.3.2 Proof of Theorem 6.2

We prove the existence of a solution to the problem (6.12)–(6.13) through a truncation and approximation argument. Set

$$\varepsilon := \min\left(\frac{l_1}{4}, \frac{l_2}{4}\right) > 0.$$

We first fix a sequence of cut-off functions $(\delta^n)_{n \in \mathbb{N}}$ in $C(\mathbb{R})$ such that, for each $n \in \mathbb{N}$,

$$0 \leq \delta^n \leq 1 \text{ in } \mathbb{R}, \quad \text{and} \quad \delta^n(x) := \begin{cases} 1 & \text{if } x \in [-nl - \varepsilon + l_2, nl - l_1 + \varepsilon], \\ 0 & \text{if } x \notin (-nl, nl). \end{cases} \quad (6.40)$$

We can for instance define uniquely δ^n by also assuming that δ^n is affine in $[-nl, -nl - \varepsilon + l_2]$ and in $[nl - l_1 + \varepsilon, nl]$.

Let us now take any nonnegative bounded continuous function $u_0 : \mathbb{R} \rightarrow \mathbb{R}$. For each $n \in \mathbb{N}$, we consider the truncated problem (6.21)–(6.24) on $[-nl, nl]$, with initial condition $\delta^n u_0|_{[-nl, nl]}$. This problem involves $4n$ patches still identified by $I_{2(-n)}, I_{1(-n+1)}, \dots, I_{2(n-1)}, I_{1n}$ as before, and the nonnegative initial condition $\delta^n u_0|_{[-nl, nl]}$ belongs to the space \mathcal{C}_0 defined in (6.25). Therefore, by Theorem 6.11, there is a unique bounded classical solution u^n of (6.21)–(6.24) in $[0, +\infty) \times [-nl, nl]$ with initial condition $\delta^n u_0|_{[-nl, nl]}$, and u^n also satisfies (6.26) in $[0, +\infty) \times [-nl, nl]$. Moreover, for every $m < n \in \mathbb{N}$, one has

$$0 \leq u^m(0, \cdot) = \delta^m u_0|_{[-ml, ml]} \leq u_0|_{[-ml, ml]} = \delta^n u_0|_{[-ml, ml]} = u^n(0, \cdot) \text{ in } [-ml, ml]$$

and $u^n(t, \pm ml) \geq 0$ for all $t \geq 0$ by (6.26), hence

$$u^m \leq u^n|_{[0, +\infty) \times [-ml, ml]} \text{ in } [0, +\infty) \times [-ml, ml]$$

by Proposition 6.23. As a consequence, for each $(t, x) \in [0, +\infty) \times \mathbb{R}$, the sequence $(u^n(t, x))_{n \geq |x|/l}$ is non-decreasing and ranges in $[0, K]$ with

$$K := \max(K_1, K_2, \|u_0\|_{L^\infty(\mathbb{R})}), \quad (6.41)$$

hence the sequence $(u^n(t, x))_{n \geq |x|/l}$ converges to a quantity $u(t, x) \in [0, K]$, that is,

$$u^n(t, x) \rightarrow u(t, x) \in [0, K] \text{ as } n \rightarrow +\infty. \quad (6.42)$$

Notice also that, if $u_0 \not\equiv 0$, then $u^n(0, \cdot) \geq \not\equiv 0$ in $[-nl, nl]$ for all n large enough, hence $u^n > 0$ in $(0, +\infty) \times (-nl, nl)$ for all n large enough by Proposition 6.23, and finally $u(t, x) > 0$ for all $(t, x) \in (0, +\infty) \times \mathbb{R}$ because the sequence $(u^n(t, x))_{n \geq |x|/l}$ is non-decreasing for each $(t, x) \in [0, +\infty) \times \mathbb{R}$.

In order to show that u is a classical solution of (6.12)–(6.13), we need further differential

6. Propagation phenomena in periodic patchy landscapes with interface conditions

estimates on the sequence $(u^n)_{n \in \mathbb{N}}$. Consider any $0 < \tau \leq \tau' < +\infty$ and any patch $I \subset \mathbb{R}$. Let us assume that I is of type 1, that is, $I = I_{1m} = (ml - l_1, ml)$ for some $m \in \mathbb{Z}$ (the case of a patch I of type 2 can be dealt with similarly). Let us fix an arbitrary $\nu \in (0, 1/2)$, say for instance $\nu = 1/4$. Since the solutions u^n (for $n \geq |m| + 1$) of (6.21)–(6.24) are uniformly bounded in $[0, +\infty) \times [-(|m| + 1)l, (|m| + 1)l]$, it follows from standard interior parabolic estimates that

$$\sup_{n \geq |m|+1} \|u^n(\cdot, ml - l_1 - \varepsilon)\|_{C^{1,\nu}([\tau/2, +\infty))} + \sup_{n \geq |m|+1} \|u^n(\cdot, ml + \varepsilon)\|_{C^{1,\nu}([\tau/2, +\infty))} \leq C_0,$$

for some positive constant C_0 only depending on $\tau, l_{1,2}, d_2, f_2$ and K given in (6.41), hence on $\tau, l_{1,2}, d_2, f_{1,2}$ and $\|u_0\|_{L^\infty(\mathbb{R})}$. Consider then two $C^3([ml - l_1 - \varepsilon, ml + \varepsilon])$ functions $g : [ml - l_1 - \varepsilon, ml + \varepsilon] \rightarrow [0, 1]$ and $h : [ml - l_1 - \varepsilon, ml + \varepsilon] \rightarrow [0, 1]$ such that

$$\begin{cases} g(ml - l_1 - \varepsilon) = h(ml + \varepsilon) = 0, \\ g(ml + \varepsilon) = h(ml - l_1 - \varepsilon) = 1, \\ g'(ml - l_1) = h'(ml - l_1) = g'(ml) = h'(ml) = 0. \end{cases}$$

They can be chosen so that their $C^3([ml - l_1 - \varepsilon, ml + \varepsilon])$ norms only depend on $l_{1,2}$. Consider now, for each $n \geq |m| + 1$, the function \tilde{u}^n defined in $[\tau/2, +\infty) \times [ml - l_1 - \varepsilon, ml + \varepsilon]$ by

$$\tilde{u}^n(t, x) = u^n(t, x) - h(x)u^n(t, ml - l_1 - \varepsilon) - g(x)u^n(t, ml + \varepsilon). \quad (6.43)$$

Each such function \tilde{u}^n is continuous in $[\tau/2, +\infty) \times [ml - l_1 - \varepsilon, ml + \varepsilon]$ and has restrictions of class $C_{t;x}^{1;2}$ in $[\tau/2, +\infty) \times [ml - l_1 - \varepsilon, ml - l_1]$, in $[\tau/2, +\infty) \times [ml - l_1, ml] = [\tau/2, +\infty) \times \bar{I}$ and in $[\tau/2, +\infty) \times [ml, ml + \varepsilon]$. Furthermore, from (6.21)–(6.24) and (6.43), one has

$$\left\{ \begin{array}{ll} \frac{\partial \tilde{u}^n}{\partial t} = d_2 \frac{\partial^2 \tilde{u}^n}{\partial x^2} + \tilde{f}_2^n(t, x, \tilde{u}^n(t, x)), & t \geq \tau/2, x \in (ml - l_1 - \varepsilon, ml - l_1), \\ \frac{\partial \tilde{u}^n}{\partial t} = d_1 \frac{\partial^2 \tilde{u}^n}{\partial x^2} + \tilde{f}_1^n(t, x, \tilde{u}^n(t, x)), & t \geq \tau/2, x \in (ml - l_1, ml), \\ \frac{\partial \tilde{u}^n}{\partial t} = d_2 \frac{\partial^2 \tilde{u}^n}{\partial x^2} + \tilde{f}_2^n(t, x, \tilde{u}^n(t, x)), & t \geq \tau/2, x \in (ml, ml + \varepsilon), \\ \tilde{u}^n(t, ml - l_1 - \varepsilon) = \tilde{u}^n(t, ml + \varepsilon) = 0, & t \geq \tau/2, \\ \tilde{u}^n(t, (ml - l_1)^-) = \tilde{u}^n(t, (ml - l_1)^+), & t \geq \tau/2, \\ \sigma \tilde{u}_x^n(t, (ml - l_1)^-) = \tilde{u}_x^n(t, (ml - l_1)^+), & t \geq \tau/2, \\ \tilde{u}^n(t, (ml)^-) = \tilde{u}^n(t, (ml)^+), & t \geq \tau/2, \\ \tilde{u}_x^n(t, (ml)^-) = \sigma \tilde{u}_x^n(t, (ml)^+), & t \geq \tau/2, \end{array} \right.$$

with

$$\begin{aligned}\tilde{f}_i^n(t, x, s) &= f_i(s + h(x)u^n(t, ml - l_1 - \varepsilon) + g(x)u^n(t, ml + \varepsilon)) \\ &\quad - h(x)u_t^n(t, ml - l_1 - \varepsilon) - g(x)u_t^n(t, ml + \varepsilon) \\ &\quad + d_i h''(x)u^n(t, ml - l_1 - \varepsilon) + d_i g''(x)u^n(t, ml + \varepsilon).\end{aligned}$$

In other words, each function \tilde{u}^n solves a truncated problem similar to (6.21)–(6.24), but this time on the interval $[ml - l_1 - \varepsilon, ml + \varepsilon]$ (with only three patches) and with nonlinearities $\tilde{f}_i^n(t, x, s)$ which are still of class C^1 with respect to s , with partial derivatives equal to $f'_i(s + h(x)u^n(t, ml - l_1 - \varepsilon) + g(x)u^n(t, ml + \varepsilon))$, and are now Hölder continuous of any exponent ν with respect to $(t, x) \in [\tau/2, +\infty) \times [ml - l_1 - \varepsilon, ml + \varepsilon]$ uniformly with respect to s and n . Remember that $\tau' \geq \tau$, hence $\tau' - \tau/2 \geq \tau/2$. Since the sequence $(\tilde{u}^n(\tau' - \tau/2, \cdot))_{n \geq |m|+1}$ is bounded in particular in $L^2(ml - l_1 - \varepsilon, ml + \varepsilon)$, it then follows with similar notations and arguments as in the proof of Theorem 6.11 that there is a universal constant $\gamma \in (0, 1)$ such that the sequence

$$\left(\tilde{u}^n(\tau' - \tau/4, \cdot)|_{(ml-l_1-\varepsilon, ml-l_1)}, \tilde{u}^n(\tau' - \tau/4, \cdot)|_{(ml-l_1, ml)}, \tilde{u}^n(\tau' - \tau/4, \cdot)|_{(ml, ml+\varepsilon)} \right)_{n \geq |m|+1}$$

is bounded in the set $\mathcal{D}(A)$ (defined as in (6.30), but with now only three patches) and the sequences $(\tilde{u}^n)_{n \geq |m|+1}$ and $(\tilde{u}_t^n)_{n \geq |m|+1}$ are bounded in $C^\gamma([\tau', \tau'+1] \times [ml - l_1 - \varepsilon, ml + \varepsilon])$, with bounds depending only on $\sup_{n \geq |m|+1} \|\tilde{u}^n(\tau' - \tau/2, \cdot)\|_{L^2(ml-l_1-\varepsilon, ml+\varepsilon)}$, τ , $l_{1,2}$, $d_{1,2}$, $f_{1,2}$ and σ , hence only on τ , $l_{1,2}$, $d_{1,2}$, $f_{1,2}$, σ and $\|u_0\|_{L^\infty(\mathbb{R})}$ (notice that these bounds are independent of $\tau' \in [\tau, +\infty)$). Owing to the definitions of \tilde{f}_i^n and \tilde{u}^n , one infers that the sequence $(\tilde{f}_i^n(\cdot, \cdot, \tilde{u}^n(\cdot, \cdot)))_{n \geq |m|+1}$ is bounded in $C^\gamma([\tau', \tau'+1] \times [ml - l_1 - \varepsilon, ml + \varepsilon])$, hence so is the sequence

$$\left(\frac{\partial^2 \tilde{u}^n|_{[\tau', \tau'+1] \times [ml-l_1-\varepsilon, ml-l_1]}}{\partial x^2}, \frac{\partial^2 \tilde{u}^n|_{[\tau', \tau'+1] \times [ml-l_1, ml]}}{\partial x^2}, \frac{\partial^2 \tilde{u}^n|_{[\tau', \tau'+1] \times [ml, ml+\varepsilon]}}{\partial x^2} \right)_{n \geq |m|+1}$$

in $C^\gamma([\tau', \tau'+1] \times [ml - l_1 - \varepsilon, ml - l_1]) \times C^\gamma([\tau', \tau'+1] \times [ml - l_1, ml]) \times C^\gamma([\tau', \tau'+1] \times [ml, ml + \varepsilon])$, with bounds depending only on τ , $l_{1,2}$, $d_{1,2}$, $f_{1,2}$, σ and $\|u_0\|_{L^\infty(\mathbb{R})}$. Finally, using (6.43) again, the sequence $(u^n|_{[\tau', \tau'+1] \times \bar{I}})_{n \geq m+1}$ is bounded in $C_{t;x}^{1,\gamma;2,\gamma}([\tau', \tau'+1] \times \bar{I})$, and, since the bound does not depend on $\tau' \in [\tau, +\infty)$, the sequence $(u^n|_{[\tau, +\infty) \times \bar{I}})_{n \geq m+1}$ is bounded in $C_{t;x}^{1,\gamma;2,\gamma}([\tau, +\infty) \times \bar{I})$ by a constant depending only on τ , $l_{1,2}$, $d_{1,2}$, $f_{1,2}$, σ and $\|u_0\|_{L^\infty(\mathbb{R})}$.

From the Arzelà-Ascoli theorem and the uniqueness of the limit u in (6.42), it follows that $u^n \rightarrow u$ as $n \rightarrow +\infty$ in $C_{t;x}^{1,2}([\tau_1, \tau_2] \times \bar{I})$ for every $0 < \tau_1 \leq \tau_2$ and every patch $I \subset \mathbb{R}$, hence u is a bounded classical solution of (6.12)–(6.13) in $(0, +\infty) \times \mathbb{R}$. Furthermore, for every $\tau > 0$ and every patch $I \subset \mathbb{R}$, there holds

$$\|u|_{[\tau, +\infty) \times \bar{I}}\|_{C_{t;x}^{1,\gamma;2,\gamma}([\tau, +\infty) \times \bar{I})} \leq C,$$

6. Propagation phenomena in periodic patchy landscapes with interface conditions

for some constant C only depending on $\tau, l_{1,2}, d_{1,2}, f_{1,2}, \sigma$ and $\|u_0\|_{L^\infty(\mathbb{R})}$.

Next, we shall prove the continuity of the function u up to time $t = 0$. Fix any $x_0 \in \mathbb{R}$, $R > 0$, and $\eta > 0$. With $K = \max(K_1, K_2, \|u_0\|_{L^\infty(\mathbb{R})})$ as in (6.41), one can choose two nonnegative functions \underline{u}_0 and \bar{u}_0 in $C^2(\mathbb{R}) \cap L^\infty(\mathbb{R})$ such that both \underline{u}_0 and $K - \bar{u}_0$ are supported in $[x_0 - 2R, x_0 + 2R]$, and such that

$$0 \leq \underline{u}_0(x) \leq u_0(x) \leq \bar{u}_0(x) \leq K \quad \text{for all } x \in [x_0 - 2R, x_0 + 2R], \quad (6.44)$$

and

$$u_0(x) - \eta \leq \underline{u}_0(x) \leq u_0(x) \leq \bar{u}_0(x) \leq u_0(x) + \eta \quad \text{for all } x \in [x_0 - R, x_0 + R]. \quad (6.45)$$

These functions \underline{u}_0 and \bar{u}_0 can also be chosen so that their derivatives vanish at all interface points in $[x_0 - 2R, x_0 + 2R]$. There are then $B > 0$ large enough and $t_0 > 0$ small enough such that $Bt_0 \leq 1$ and the $C_{t;x}^{1;2}([0, +\infty) \times \mathbb{R})$ functions $(t, x) \mapsto \underline{u}_0(x) - Bt$ and $(t, x) \mapsto \bar{u}_0(x) + Bt$ are, respectively, a sub- and a supersolution of truncated problem (6.21)–(6.24) for $(t, x) \in [0, t_0] \times [-nl, nl]$ and for any $n \in \mathbb{N}$ large enough so that $[x_0 - 2R, x_0 + 2R] \subset [-nl, nl]$ and $\delta^n u_0 = u_0$ in $[x_0 - 2R, x_0 + 2R]$, where δ^n is the cut-off function defined in (6.40). Remembering (6.44), the inequality (6.26) satisfied by u^n and the fact that \underline{u}_0 and $K - \bar{u}_0$ are supported in $[x_0 - 2R, x_0 + 2R]$ (hence, $\underline{u}_0(\pm nl) - Bt \leq 0 \leq K \leq \bar{u}_0(\pm nl) + Bt$ for all $t \geq 0$), it follows from Proposition 6.23 that

$$\underline{u}_0(x) - Bt \leq u^n(t, x) \leq \bar{u}_0(x) + Bt \quad \text{for all } (t, x) \in [0, t_0] \times [-nl, nl]$$

and for all n large enough. By passing to the limit $n \rightarrow +\infty$ for any $(t, x) \in (0, t_0] \times \mathbb{R}$, one gets that

$$\underline{u}_0(x) - Bt \leq u(t, x) \leq \bar{u}_0(x) + Bt \quad \text{for all } (t, x) \in (0, t_0] \times \mathbb{R}.$$

Together with (6.45), there is then $t_1 > 0$ such that $|u(t, x) - u_0(x)| \leq 2\eta$ for all $(t, x) \in (0, t_1] \times [x_0 - R, x_0 + R]$. Finally, since $\eta > 0$ was arbitrary, this shows that u is continuous up to time $t = 0$, and that $u(t, \cdot) \rightarrow u_0$ locally uniformly as $t \rightarrow 0^+$. To sum up, u is a nonnegative bounded classical solution of (6.12)–(6.13) in $[0, +\infty) \times \mathbb{R}$ with initial condition u_0 , in the sense of Definition 6.1.

We point out that the definition of the solution u does not depend on the choice of the sequence of cut-off functions $(\delta^n)_{n \in \mathbb{N}}$ given in (6.40). So, let $(\widehat{\delta}^n)_{n \in \mathbb{N}}$ be another such sequence, and, for each $n \in \mathbb{N}$, let \widehat{u}^n be the unique bounded classical solution of (6.21)–(6.24) with initial condition $\widehat{\delta}^n u_0|_{[-nl, nl]}$. As above, the sequence $(\widehat{u}^n)_{n \in \mathbb{N}}$ converges monotonically pointwise in $[0, +\infty) \times \mathbb{R}$ to a nonnegative bounded classical solution \widehat{u} of (6.12)–(6.13) in

6.3. Well-posedness of the Cauchy problem (6.12)–(6.13): proof of Theorem 6.2

$[0, +\infty) \times \mathbb{R}$. Furthermore, for every $n \in \mathbb{N}$, one has

$$u^n(0, \cdot) = \delta^n u_0|_{[-nl, nl]} \leq u_0|_{[-nl, nl]} = \widehat{\delta}^{n+1} u_0|_{[-nl, nl]} = \widehat{u}^{n+1}(0, \cdot)|_{[-nl, nl]} \quad \text{in } [-nl, nl].$$

Since \widehat{u}^{n+1} is nonnegative in $[0, +\infty) \times [-(n+1)l, (n+1)l]$ and in particular on $[0, +\infty) \times \{\pm nl\}$, Proposition 6.23 implies that $u^n \leq \widehat{u}^{n+1}$ in $[0, +\infty) \times [-nl, nl]$. The passage to the limit as $n \rightarrow +\infty$ pointwise in $[0, +\infty) \times \mathbb{R}$ yields $u \leq \widehat{u}$ in $[0, +\infty) \times \mathbb{R}$. The reverse inequality also holds similarly, hence $u \equiv \widehat{u}$ in $[0, +\infty) \times \mathbb{R}$.

Consider now the case where u_0 is periodic, that is, $u_0(x) = u_0(x+l)$ for all $x \in \mathbb{R}$. With the same notations as above, for every $n \in \mathbb{N}$, one has

$$u^n(0, x) = \delta^n(x) u_0(x) \leq \delta^{n+2}(x+l) u_0(x+l) = u^{n+2}(0, x+l) \quad \text{for all } x \in [-nl, nl].$$

Since $u^{n+2}(t, -nl+l) \geq 0$ and $u^{n+2}(t, nl+l) \geq 0$ for all $t \geq 0$, Proposition 6.23 implies that $u^n(t, x) \leq u^{n+2}(t, x+l)$ for all $(t, x) \in [0, +\infty) \times [-nl, nl]$, hence $u(t, x) \leq u(t, x+l)$ for all $(t, x) \in [0, +\infty) \times \mathbb{R}$. The reverse inequality can be proved similarly. Therefore,

$$u(t, x) = u(t, x+l) \quad \text{for all } (t, x) \in [0, +\infty) \times \mathbb{R}.$$

Let us then show a comparison principle for the solutions constructed above. Consider any two nonnegative bounded continuous functions u_0 and v_0 such that

$$0 \leq u_0 \leq v_0 \quad \text{in } \mathbb{R}.$$

For each $n \in \mathbb{N}$, let u^n and v^n be the unique bounded classical solutions of (6.21)–(6.24) with respective initial conditions $\delta^n u_0|_{[-nl, nl]}$ and $\delta^n v_0|_{[-nl, nl]}$. The sequences $(u^n)_{n \in \mathbb{N}}$ and $(v^n)_{n \in \mathbb{N}}$ converge monotonically pointwise in $[0, +\infty) \times \mathbb{R}$ to nonnegative bounded classical solutions u and v of (6.12)–(6.13) in $[0, +\infty) \times \mathbb{R}$. Since for each $n \in \mathbb{N}$, one has $u^n(0, \cdot) \leq v^n(0, \cdot)$ in $[-nl, nl]$, Proposition 6.23 yields $u^n \leq v^n$ in $[0, +\infty) \times [-nl, nl]$, hence

$$u \leq v \quad \text{in } [0, +\infty) \times \mathbb{R}$$

at the limit $n \rightarrow +\infty$.

Finally, let us show the local-in-time continuous dependence of the solutions u with respect to the initial condition. We actually show more, that is, for each $T > 0$, the map $u_0 \mapsto u$ is Lipschitz continuous from $C^+(\mathbb{R}) \cap L^\infty(\mathbb{R})$ to $C([0, T] \times \mathbb{R}) \cap L^\infty([0, T] \times \mathbb{R})$ equipped with the sup norms. Consider two functions u_0, v_0 in $C^+(\mathbb{R}) \cap L^\infty(\mathbb{R})$, and denote

$$\underline{u}_0 = \max(0, u_0 - \|u_0 - v_0\|_{L^\infty(\mathbb{R})}) \quad \text{and} \quad \bar{u}_0 = u_0 + \|u_0 - v_0\|_{L^\infty(\mathbb{R})}.$$

Then, \underline{u}_0 and \bar{u}_0 are in $C^+(\mathbb{R}) \cap L^\infty(\mathbb{R})$, and $0 \leq \underline{u}_0 \leq \min(u_0, v_0) \leq \max(u_0, v_0) \leq \bar{u}_0$

6. Propagation phenomena in periodic patchy landscapes with interface conditions

in \mathbb{R} , with $\|\bar{u}_0 - \underline{u}_0\|_{L^\infty(\mathbb{R})} \leq 2\|u_0 - v_0\|_{L^\infty(\mathbb{R})}$. For each $n \in \mathbb{N}$, let u^n , v^n , \underline{u}^n and \bar{u}^n be the unique bounded classical solutions of (6.21)–(6.24) with respective initial conditions $\delta^n u_0|_{[-nl, nl]}$, $\delta^n v_0|_{[-nl, nl]}$, $\delta^n \underline{u}_0|_{[-nl, nl]}$ and $\delta^n \bar{u}_0|_{[-nl, nl]}$, with the cut-off function δ^n given in (6.40). The sequences $(u^n)_{n \in \mathbb{N}}$, $(v^n)_{n \in \mathbb{N}}$, $(\underline{u}^n)_{n \in \mathbb{N}}$ and $(\bar{u}^n)_{n \in \mathbb{N}}$ converge monotonically pointwise in $[0, +\infty) \times \mathbb{R}$ to some nonnegative bounded classical solutions u , v , \underline{u} and \bar{u} of (6.12)–(6.13) in $[0, +\infty) \times \mathbb{R}$, with respective initial conditions u_0 , v_0 , \underline{u}_0 and \bar{u}_0 . Now, for each $n \in \mathbb{N}$, one has

$$\begin{aligned} 0 \leq \underline{u}^n(0, \cdot) = \delta^n \underline{u}_0|_{[-nl, nl]} &\leq \min(\delta^n u_0|_{[-nl, nl]}, \delta^n v_0|_{[-nl, nl]}) \leq \max(\delta^n u_0|_{[-nl, nl]}, \delta^n v_0|_{[-nl, nl]}) \\ &\leq \delta^n \bar{u}_0|_{[-nl, nl]} = \bar{u}^n(0, \cdot) \leq \bar{u}_0|_{[-nl, nl]} \leq \|\bar{u}_0\|_{L^\infty(\mathbb{R})} \end{aligned}$$

in $[-nl, nl]$ and $\|\bar{u}^n(0, \cdot) - \underline{u}^n(0, \cdot)\|_{L^\infty([-nl, nl])} \leq 2\|u_0 - v_0\|_{L^\infty(\mathbb{R})}$. From the previous paragraphs, one has

$$0 \leq \underline{u}^n \leq \min(u^n, v^n) \leq \max(u^n, v^n) \leq \bar{u}^n \leq \bar{K} := \max(K_1, K_2, \|\bar{u}_0\|_{L^\infty(\mathbb{R})}) \quad (6.46)$$

in $[0, +\infty) \times [-nl, nl]$. The function $w^n := \bar{u}^n - \underline{u}^n$ is continuous and nonnegative in $[0, +\infty) \times [-nl, nl]$ and its restriction to $(0, +\infty) \times \bar{I}$, for a patch I of type $i \in \{1, 2\}$ included in $(-nl, nl)$, is of class $C_{t;x}^{1;2}((0, +\infty) \times \bar{I})$ and satisfies

$$\frac{\partial w^n}{\partial t} = d_i \frac{\partial^2 w^n}{\partial x^2} + f_i(\bar{u}^n(t, x)) - f_i(\underline{u}^n(t, x)) \leq d_i \frac{\partial^2 w^n}{\partial x^2} + Lw^n \quad \text{in } (0, +\infty) \times I,$$

with $L := \max(\|f'_1\|_{L^\infty([0, \bar{K}])}, \|f'_2\|_{L^\infty([0, \bar{K}])}) \in [0, +\infty)$. Furthermore, the function w^n satisfies the interface conditions (6.22) and it vanishes on $[0, +\infty) \times \{\pm nl\}$. On the other hand, the nonnegative $C^\infty([0, +\infty) \times [-nl, nl])$ function $(t, x) \mapsto \bar{w}(t, x) := 2\|u_0 - v_0\|_{L^\infty(\mathbb{R})} e^{Lt}$ satisfies the interface conditions (since it is independent of x) in (6.22) and $\frac{\partial \bar{w}}{\partial t} = L\bar{w} = d_i \frac{\partial^2 \bar{w}}{\partial x^2} + L\bar{w}$ in $[0, +\infty) \times \bar{I}$, for each patch I of type $i \in \{1, 2\}$. Lastly,

$$0 \leq w^n(0, \cdot) = \bar{u}^n(0, \cdot) - \underline{u}^n(0, \cdot) \leq 2\|u_0 - v_0\|_{L^\infty(\mathbb{R})} = \bar{w}(0, \cdot) \quad \text{in } [-nl, nl].$$

Proposition 6.23 then implies that $0 \leq \bar{u}^n(t, x) - \underline{u}^n(t, x) = w^n(t, x) \leq \bar{w}(t, x)$ for all $(t, x) \in [0, +\infty) \times [-nl, nl]$. By passing to the limit as $n \rightarrow +\infty$ pointwise in $[0, +\infty) \times \mathbb{R}$, one gets that $0 \leq \bar{u}(t, x) - \underline{u}(t, x) \leq 2\|u_0 - v_0\|_{L^\infty(\mathbb{R})} e^{Lt}$, while $0 \leq \underline{u} \leq \min(u, v) \leq \max(u, v) \leq \bar{u}$ in $[0, +\infty) \times \mathbb{R}$ by (6.46). As a conclusion,

$$|u(t, x) - v(t, x)| \leq 2\|u_0 - v_0\|_{L^\infty(\mathbb{R})} e^{Lt} \quad \text{for all } (t, x) \in [0, +\infty) \times \mathbb{R}, \quad (6.47)$$

which yields the Lipschitz continuity of the map $u_0 \mapsto u$ from $C^+(\mathbb{R}) \cap L^\infty(\mathbb{R})$ to $C([0, T] \times \mathbb{R}) \cap L^\infty([0, T] \times \mathbb{R})$ equipped with the sup norms, for each $T > 0$. As a conclusion, the proof of Theorem 6.2 is complete. \square

6.4 Existence and uniqueness of a stationary solution

In this section, we focus on the stationary problem (6.17). In Section 6.4.1, we show Theorem 6.3 on the existence and non-existence of a positive periodic bounded solution of (6.17). Section 6.4.2 is devoted to the proof of Theorem 6.4 on the uniqueness of such a solution.

6.4.1 Existence of solutions: proof of Theorem 6.3

(i) Assume that (6.14) is fulfilled and that 0 is an unstable solution of (6.17), that is, $\lambda_1 < 0$, where λ_1 is the principal eigenvalue of the eigenvalue problem (6.16), associated with the principal eigenfunction ϕ . Since $f(x, \cdot)|_I = f_i$ is of class $C^1(\mathbb{R})$ for each $x \in \mathbb{R} \setminus S$ belonging to a patch I of type $i \in \{1, 2\}$, there exists $\kappa_0 > 0$ small enough such that, for all $0 < \kappa \leq \kappa_0$,

$$f(x, \kappa\phi(x)) \geq \kappa\phi(x)f_s(x, 0) + \frac{\lambda_1}{2}\kappa\phi(x) \text{ for all } x \in \mathbb{R} \setminus S,$$

hence $\kappa\phi$ then satisfies

$$-d(x)\kappa\phi''(x) - f(x, \kappa\phi(x)) \leq -d(x)\kappa\phi''(x) - \kappa\phi(x)f_s(x, 0) - \frac{\lambda_1}{2}\kappa\phi(x) = \frac{\lambda_1}{2}\kappa\phi(x) < 0 \quad (6.48)$$

for all $x \in \mathbb{R} \setminus S$, as well as the interface conditions in (6.17). With $M > 0$ as in (6.14), we can then fix $\kappa \in (0, \kappa_0]$ so that $\kappa\phi \leq M$ in \mathbb{R} . Now, for each $n \in \mathbb{N}$, let u^n be the unique bounded classical solution of (6.21)–(6.24) with initial condition $u^n(0, \cdot) = M\delta^n|_{[-nl, nl]}$, with the cut-off function δ^n given in (6.40). From the proof of Theorem 6.2, the sequence $(u^n)_{n \in \mathbb{N}}$ converges monotonically pointwise in $[0, +\infty) \times \mathbb{R}$ to a nonnegative bounded classical solution u of (6.12)–(6.13) in $[0, +\infty) \times \mathbb{R}$, with initial condition M , and $u(t, x) = u(t, x + l)$ for all $(t, x) \in [0, +\infty) \times \mathbb{R}$. Furthermore, by (6.14), the constant M is a supersolution of (6.21)–(6.24) in $[0, +\infty) \times [-nl, nl]$ for each $n \in \mathbb{N}$, in the sense of Definition 6.22. Proposition 6.23 implies that

$$u^n(t, x) \leq M \text{ for all } t \geq 0 \text{ and } x \in [-nl, nl].$$

In particular, for each $h \geq 0$ and $n \in \mathbb{N}$, one has $u^n(h, x) \leq M = u^{n+1}(0, x)$ for all $x \in [-nl, nl]$, together with $u^n(t + h, \pm nl) = 0 \leq u^{n+1}(t, \pm nl)$ for all $t \geq 0$. Hence $u^n(t + h, x) \leq u^{n+1}(t, x)$ for all $t \geq 0$ and $x \in [-nl, nl]$, by Proposition 6.23 again. Therefore,

$$u(t + h, x) \leq u(t, x) \text{ for all } (t, x) \in [0, +\infty) \times \mathbb{R},$$

by passing to the limit as $n \rightarrow +\infty$. In other words, the nonnegative continuous function u is non-increasing in t , and, together with the periodicity in space and the Schauder estimates of Theorem 6.2, there is a continuous periodic solution $p : \mathbb{R} \rightarrow [0, M]$ of (6.17) such that $u(t, \cdot) \rightarrow p$ uniformly in \mathbb{R} as $t \rightarrow +\infty$, and $u(t, \cdot)|_{\bar{I}} \rightarrow p|_{\bar{I}}$ in $C^2(\bar{I})$ for each patch $I \subset \mathbb{R}$.

6. Propagation phenomena in periodic patchy landscapes with interface conditions

Finally, since the periodic continuous function $\kappa\phi$ has restrictions of class $C^2(\bar{I})$ for each patch $I \subset \mathbb{R}$ and satisfies (6.48) and the interface conditions in (6.17) (it is a subsolution of this problem), and since $\kappa\phi \leq M = u(0, \cdot)$ in \mathbb{R} , a similar comparison result as in Proposition 6.23 (but adapted here to the case of spatially periodic super- and subsolutions) yields $\kappa\phi(x) \leq u(t, x)$ for all $t \geq 0$ and $x \in \mathbb{R}$, hence $\kappa\phi(x) \leq p(x)$ for all $x \in \mathbb{R}$ at the limit $t \rightarrow +\infty$. As a conclusion, there exists a positive and periodic continuous solution p of (6.17) satisfying $\kappa\phi \leq p \leq M$ in \mathbb{R} , that is, Theorem 6.3 (i) is proved.

(ii) Next, in addition to (6.14), we assume that (6.15) holds, that p is a nonnegative bounded continuous solution to the elliptic problem (6.17), and that 0 is a stable solution of (6.17), that is, $\lambda_1 \geq 0$. Let ϕ be the unique positive solution of (6.16). In (6.15), let us assume that $s \mapsto f_1(s)/s$ is decreasing with respect to $s > 0$ (the case when $s \mapsto f_2(s)/s$ is decreasing with respect to $s > 0$ can be handled similarly). We infer that, for every $\gamma > 0$,

$$f(x, \gamma\phi(x)) = f_1(\gamma\phi(x)) < f_1'(0)\gamma\phi(x) = f_s(x, 0)\gamma\phi(x) \text{ for all } x \in (nl - l_1, nl) \text{ and } n \in \mathbb{Z},$$

while

$$f(x, \gamma\phi(x)) = f_2(\gamma\phi(x)) \leq f_2'(0)\gamma\phi(x) = f_s(x, 0)\gamma\phi(x) \text{ for all } x \in (nl, nl + l_2) \text{ and } n \in \mathbb{Z}.$$

Hence, for all $\gamma > 0$,

$$\begin{cases} -d_1\gamma\phi''(x) - f_1(\gamma\phi(x)) > -d_1\gamma\phi''(x) - f_1'(0)\gamma\phi(x) = \lambda_1\gamma\phi(x) \geq 0, & x \in (nl - l_1, nl), \\ -d_2\gamma\phi''(x) - f_2(\gamma\phi(x)) \geq -d_2\gamma\phi''(x) - f_2'(0)\gamma\phi(x) = \lambda_1\gamma\phi(x) \geq 0, & x \in (nl, nl + l_2). \end{cases} \quad (6.49)$$

Since ϕ is bounded from below by a positive constant (because it is positive, periodic and continuous), and since p is bounded, one can define

$$\gamma^* = \inf \{ \gamma > 0, \gamma\phi > p \text{ in } \mathbb{R} \} \in [0, +\infty).$$

Our goal is to show that $\gamma^* = 0$. Assume by way of contradiction that $\gamma^* > 0$, and set $z := \gamma^*\phi - p$. Then $z \geq 0$ in \mathbb{R} and there exists a sequence $(x_m)_{m \in \mathbb{N}}$ in \mathbb{R} such that $z(x_m) \rightarrow 0$ as $m \rightarrow +\infty$. Moreover, z satisfies

$$\begin{cases} -d_1z''(x) - b(x)z(x) > 0, & x \in (nl - l_1, nl), \\ -d_2z''(x) - b(x)z(x) \geq 0, & x \in (nl, nl + l_2), \\ z(x^-) = z(x^+), \quad z'(x^-) = \sigma z'(x^+), & x = nl, \\ z(x^-) = z(x^+), \quad \sigma z'(x^-) = z'(x^+), & x = nl + l_2, \end{cases} \quad (6.50)$$

for some bounded function b defined in $\mathbb{R} \setminus S$.

Assume at first that up to a subsequence, $x_m \rightarrow \bar{x} \in \mathbb{R}$ as $m \rightarrow +\infty$. By continuity of ϕ

and p , one has $z(\bar{x}) = 0$. We distinguish two cases. Assume first that $\bar{x} \in \mathbb{R} \setminus S$. It is easily seen from the strong elliptic maximum principle and the Hopf lemma, applied by induction from one patch to an adjacent one, that $z \equiv 0$ in \mathbb{R} . This is a contradiction with the strict inequality in the first line of (6.50). Thus, $z > 0$ in $\mathbb{R} \setminus S$ and $\bar{x} \in S$, hence the Hopf lemma yields $z'(\bar{x}^-) < 0$ and $z'(\bar{x}^+) > 0$, contradicting the interface condition in (6.50).

In the general case, let $\bar{x}_m \in (-l_1, l_2]$ be such that $x_m - \bar{x}_m \in l\mathbb{Z}$. Then up to some subsequence, one can assume that there is $\bar{x}_\infty \in [-l_1, l_2]$ such that $\bar{x}_m \rightarrow \bar{x}_\infty$ as $m \rightarrow +\infty$. Set $z_m = \gamma^* \phi_m - p_m = \gamma^* \phi - p_m$, where $\phi_m(x) := \phi(x + x_m - \bar{x}_m) = \phi(x)$ and $p_m(x) := p(x + x_m - \bar{x}_m)$. Since $d(x)$ and $f(x, \cdot)$ are periodic in x , one then infers from (6.17) and (6.49) that each function z_m satisfies

$$\begin{cases} -d_1 z_m''(x) - f_1(\gamma^* \phi(x)) + f_1(p_m(x)) > 0, & x \in (nl - l_1, nl), \\ -d_2 z_m''(x) - f_2(\gamma^* \phi(x)) + f_2(p_m(x)) \geq 0, & x \in (nl, nl + l_2), \\ z_m(x^-) = z_m(x^+), \quad z_m'(x^-) = \sigma z_m'(x^+), & x = nl, \\ z_m(x^-) = z_m(x^+), \quad \sigma z_m'(x^-) = z_m'(x^+), & x = nl + l_2. \end{cases}$$

From standard elliptic estimates, it follows that up to some subsequence, the sequences $(p_m)_{m \in \mathbb{N}}$ and $(z_m)_{m \in \mathbb{N}}$ converge as $m \rightarrow +\infty$ to some functions p_∞ and z_∞ locally uniformly in \mathbb{R} , and in $C^2(\bar{I})$ for each patch $I \subset \mathbb{R}$, with $z_\infty = \gamma^* \phi - p_\infty$ and

$$\begin{cases} -d_1 z_\infty''(x) - f_1(\gamma^* \phi(x)) + f_1(p_\infty(x)) \geq 0, & x \in (nl - l_1, nl), \\ -d_2 z_\infty''(x) - f_2(\gamma^* \phi(x)) + f_2(p_\infty(x)) \geq 0, & x \in (nl, nl + l_2), \\ z_\infty(x^-) = z_\infty(x^+), \quad z_\infty'(x^-) = \sigma z_\infty'(x^+), & x = nl, \\ z_\infty(x^-) = z_\infty(x^+), \quad \sigma z_\infty'(x^-) = z_\infty'(x^+), & x = nl + l_2. \end{cases} \quad (6.51)$$

Moreover, $z_\infty \geq 0$ in \mathbb{R} , $z_\infty(\bar{x}_\infty) = 0$, and the first inequality in (6.51) is actually strict from the strict sign in the first line of (6.49) applied with $\gamma^* > 0$, and from the periodicity of ϕ . From similar lines as above, one reaches a contradiction by using the strong elliptic maximum principle and the Hopf lemma together with the interface conditions in (6.51).

Consequently, $\gamma^* = 0$, whence $p \equiv 0$. This completes the proof of Theorem 6.3. \square

6.4.2 Uniqueness of solutions: proof of Theorem 6.4

In order to prove the uniqueness of the positive stationary solution, we show the following crucial property.

Proposition 6.13. *Assume (6.14) and that 0 is an unstable solution of (6.17) (i.e., $\lambda_1 < 0$). Let p be a bounded nonnegative continuous solution of the stationary problem (6.17). Then, either $p \equiv 0$ in \mathbb{R} , or $\inf_{\mathbb{R}} p > 0$.*

6. Propagation phenomena in periodic patchy landscapes with interface conditions

Note that Proposition 6.13 also holds in particular in the class of periodic solutions. However, we look in Theorem 6.4 at the uniqueness within a more general class of functions which are not assumed to be *a priori* periodic. Proposition 6.13, which implies that any positive solution of (6.17) is in fact bounded from below by a positive constant, will be the essence in proving uniqueness under the additional assumption (6.15).

We prove Proposition 6.13 via a series of lemmas. First of all, for any $R > 0$ and $y \in \mathbb{R}$, we claim that there exist a unique real number (principal eigenvalue) λ_R^y and a unique nonnegative continuous and piecewise smooth function (principal eigenfunction) φ_R^y in $[-R, R]$ satisfying

$$\begin{cases} -d(x+y)(\varphi_R^y)''(x) - f_s(x+y, 0)\varphi_R^y(x) = \lambda_R^y \varphi_R^y(x), & x \in (-R, R) \setminus (S-y), \\ \varphi_R^y(x^-) = \varphi_R^y(x^+), (\varphi_R^y)'(x^-) = \sigma(\varphi_R^y)'(x^+), & x = nl - y \in (-R, R), \\ \varphi_R^y(x^-) = \varphi_R^y(x^+), \sigma(\varphi_R^y)'(x^-) = (\varphi_R^y)'(x^+), & x = nl + l_2 - y \in (-R, R), \\ \varphi_R^y > 0 \text{ in } (-R, R), \varphi_R^y(\pm R) = 0, \|\varphi_R^y\|_{L^\infty(-R, R)} = 1. \end{cases} \quad (6.52)$$

We sketch the proof below. For convenience, we denote by J_s and K_r the finitely many shifted (by $-y$) patches of type 1 and of type 2 in $(-R, R)$ so that

$$(-R, R) \setminus (S-y) = \left(\bigcup_s J_s \right) \cup \left(\bigcup_r K_r \right).$$

The functions $d(\cdot + y)$ and $f_s(\cdot + y, 0)$ are now constant in each patch J_s or K_r . Consider the Hilbert space $H = H_0^1(-R, R)$ and the Banach space

$$G = \{u \in C([-R, R]) : u|_{\overline{J_s}} \in C^1(\overline{J_s}), u|_{\overline{K_r}} \in C^1(\overline{K_r}), u(\pm R) = 0\},$$

equipped with the norms

$$\begin{cases} \|u\|_H = \sqrt{\sum_s \|u\|_{H^1(J_s)}^2 + \sum_r \frac{1}{k} \|u\|_{H^1(K_r)}^2} \\ = \sqrt{\sum_s \int_{J_s} (|u'|^2 + u^2) + \sum_r \frac{1}{k} \int_{K_r} (|u'|^2 + u^2)} \geq \min\left(1, \frac{1}{\sqrt{k}}\right) \|u\|_{H^1(-R, R)}, \\ \|u\|_G = \sum_s \|u\|_{C^1(\overline{J_s})} + \sum_r \frac{1}{k} \|u\|_{C^1(\overline{K_r})}. \end{cases}$$

Set

$$\Lambda := \max(f_1'(0), f_2'(0)) + 1. \quad (6.53)$$

For $g \in G$, let us solve the following problem

$$\begin{cases} -d(\cdot + y)u'' - f_s(\cdot + y, 0)u + \Lambda u = g, & \text{in } (-R, R) \setminus (S - y), \\ u(x^-) = u(x^+), \quad u'(x^-) = \sigma u'(x^+), & x = nl - y \in (-R, R), \\ u(x^-) = u(x^+), \quad \sigma u'(x^-) = u'(x^+), & x = nl + l_2 - y \in (-R, R), \\ u(\pm R) = 0, \end{cases} \quad (6.54)$$

first in the weak sense: that is, we look for a solution $u \in H$ such that

$$B(u, z) = \langle g, z \rangle \text{ for all } z \in H, \quad (6.55)$$

where the bilinear form B is defined by

$$B(u, z) = \sum_s \int_{J_s} (d_1 u' z' + (\Lambda - f'_1(0))uz) + \sum_r \frac{1}{k} \int_{K_r} (d_2 u' z' + (\Lambda - f'_2(0))uz), \quad (6.56)$$

and

$$\langle g, z \rangle = \sum_s \int_{J_s} gz + \sum_r \frac{1}{k} \int_{K_r} gz.$$

Clearly, the map $z \mapsto \langle g, z \rangle$ is continuous in H , and B is continuous in $H \times H$. Moreover, it is easily seen that, for any $u \in H$,

$$\begin{aligned} B(u, u) &= \sum_s \int_{J_s} (d_1 (u')^2 + (\Lambda - f'_1(0))u^2) + \sum_r \frac{1}{k} \int_{K_r} (d_2 (u')^2 + (\Lambda - f'_2(0))u^2) \\ &\geq \min(d_1, d_2, 1) \|u\|_H^2, \end{aligned}$$

whence B is coercive. The Lax-Milgram theorem yields the existence of a unique $u \in H$ (hence, u is continuous in $[-R, R]$, by identifying u with its unique continuous representative, and $u(\pm R) = 0$) satisfying (6.55), and $\|u\|_{H^1(-R, R)} \leq C_1 \|g\|_{L^2(-R, R)}$ for a positive constant C_1 only depending on $d_{1,2}$ and k . Thus,

$$\max_{[-R, R]} |u| \leq C_2 \|g\|_{L^2(-R, R)} \leq C_3 \|g\|_G$$

for some positive constants C_2 and C_3 only depending on $d_{1,2}$, k , and R . Furthermore, owing to the definitions of B in (6.56) and of σ in (6.11), the function u has restrictions in \mathcal{I} belonging to $H^2(\mathcal{I})$ for each patch \mathcal{I} of the type J_s or K_r in $(-R, R) \setminus (S - y)$ and u satisfies the equations and the interface conditions in (6.54). In particular, $-d_i u'' + (\Lambda - f'_i(0))u = g$ in $L^2(\mathcal{I})$ for each patch \mathcal{I} of the type J_s or K_r in $(-R, R) \setminus (S - y)$, hence $\max_{\mathcal{I} \in (\cup_s J_s) \cup (\cup_r K_r)} \|u|_{\mathcal{I}}''\|_{L^2(\mathcal{I})} \leq C_4 \|g\|_{L^2(-R, R)}$ for a positive constant C_4 only depending on

6. Propagation phenomena in periodic patchy landscapes with interface conditions

$d_{1,2}$, k and $f'_{1,2}(0)$, and then $u|_{\bar{\mathcal{I}}}$ in $C^1(\bar{\mathcal{I}})$ and

$$\max_{\mathcal{I} \in (\cup_s J_s) \cup (\cup_r K_r)} \left(\max_{\bar{\mathcal{I}}} |u|_{\bar{\mathcal{I}}}' \right) \leq C_5 \|g\|_G$$

for a positive constant C_5 only depending on $d_{1,2}$, k , R and $f'_{1,2}(0)$. Notice in particular that u then belongs to G . Using again the equations satisfied by u and the fact that u necessarily has an interior critical (with vanishing derivative) point in $(-R, R)$ thanks to (6.54), it follows that $u|_{\bar{\mathcal{I}}} \in C^3(\bar{\mathcal{I}})$ for each patch \mathcal{I} of the type J_s or K_r in $(-R, R) \setminus (S - y)$ and

$$\max_{\mathcal{I} \in (\cup_s J_s) \cup (\cup_r K_r)} \|u|_{\bar{\mathcal{I}}}\|_{C^3(\bar{\mathcal{I}})} \leq C_8 \|g\|_G$$

for a positive constant C_8 only depending on $d_{1,2}$, k , R and $f'_{1,2}(0)$.

The mapping $T: g \in G \mapsto Tg := u \in G$ is obviously linear. The previous estimates and the Arzelà-Ascoli theorem yield the compactness of T . Let now \mathcal{K} be the cone $\mathcal{K} = \{u \in G : u \geq 0 \text{ in } [-R, R]\}$. Its interior $\mathring{\mathcal{K}}$ is not empty, and $\mathcal{K} \cap (-\mathcal{K}) = \{0\}$. We claim that, if $g \in \mathcal{K} \setminus \{0\}$, then $u \in \mathring{\mathcal{K}}$. Indeed, by using $z := u^- = \max(-u, 0) \in H$ in (6.55) one has

$$-\sum_s \int_{J_s} (d_1((u^-)')^2 + (\Lambda - f'_1(0))(u^-)^2) - \sum_r \frac{1}{k} \int_{K_r} (d_2((u^-)')^2 + (\Lambda - f'_2(0))(u^-)^2) = \langle g, u^- \rangle \geq 0,$$

hence $u^- \equiv 0$, that is, $u \geq 0$ in $[-R, R]$. By finitely many applications of the strong elliptic maximum principle and the Hopf lemma, together with the fact that $g \not\equiv 0$, one concludes that $u > 0$ in $(-R, R)$ and that $u'(-R) > 0$ and $u'(R) < 0$. Therefore, $T(\mathcal{K} \setminus \{0\}) \subset \mathring{\mathcal{K}}$. From the Krein-Rutman theory, there exist a unique positive real number $\tilde{\lambda}_R^y$ and a unique function $\varphi_R^y \in \mathring{K}$ such that $\tilde{\lambda}_R^y T\varphi_R^y = \varphi_R^y$ and, say, $\|\varphi_R^y\|_{L^\infty(-R, R)} = 1$. Hence, φ_R^y is continuous in $[-R, R]$, of class $C^3(\bar{\mathcal{I}})$ (and then $C^\infty(\bar{\mathcal{I}})$ by induction) for each patch \mathcal{I} of the type J_s or K_s in $(-R, R) \setminus (S - y)$, and

$$\begin{cases} -d(x+y)(\varphi_R^y)''(x) - f_s(x+y, 0)\varphi_R^y(x) + \Lambda\varphi_R^y(x) = \tilde{\lambda}_R^y\varphi_R^y(x), & x \in (-R, R) \setminus (S - y), \\ \varphi_R^y(x^-) = \varphi_R^y(x^+), \quad (\varphi_R^y)'(x^-) = \sigma(\varphi_R^y)'(x^+), & x = nl - y \in (-R, R), \\ \varphi_R^y(x^-) = \varphi_R^y(x^+), \quad \sigma(\varphi_R^y)'(x^-) = (\varphi_R^y)'(x^+), & x = nl + l_2 - y \in (-R, R), \\ \varphi_R^y > 0 \text{ in } (-R, R), \quad \varphi_R^y(\pm R) = 0, \quad \|\varphi_R^y\|_{L^\infty(-R, R)} = 1. \end{cases}$$

Therefore, $\lambda_R^y := \tilde{\lambda}_R^y - \Lambda > -\Lambda = -\max(f'_1(0), f'_2(0)) - 1$ is the first eigenvalue of (6.52) associated with a unique continuous function φ_R^y in $[-R, R]$ that is positive in $(-R, R)$ and of class $C^\infty(\bar{\mathcal{I}})$ for each patch \mathcal{I} of the type J_s or K_s in $(-R, R) \setminus (S - y)$. Furthermore, for each $R > 0$, the interval $(-R, R)$ contains at least a patch \mathcal{I} of the type J_s or K_s of length larger than or equal to $\ell_R := \min(l_1, l_2, R)$, hence $\lambda_R^y \leq \max(-f'_1(0) + d_1\pi^2/\ell_R^2, -f'_2(0) + d_2\pi^2/\ell_R^2)$ from the positivity of φ_R^y in \mathcal{I} . As a consequence, for each $R > 0$, there is a

constant N_R such that

$$|\tilde{\lambda}_{R'}^y| + |\lambda_{R'}^y| \leq N_R \text{ for every } R' \geq R \text{ and } y \in \mathbb{R}.$$

Since both λ_R^y and φ_R^y are unique, the aforementioned estimates and compactness arguments imply that, for each $R > 0$, the maps $y \mapsto \lambda_R^y$ and $y \mapsto \varphi_R^y$ are continuous in \mathbb{R} (the continuity of $y \mapsto \varphi_R^y$ is understood in the sense of the uniform topology in $[-R, R]$). Note also that since d and f are periodic in x , it follows that λ_R^y and φ_R^y are periodic with respect to y as well.

Similarly, for each $y \in \mathbb{R}$, there exist a unique principal eigenvalue λ^y and a unique principal eigenfunction ϕ^y of the periodic problem

$$\begin{cases} -d(x+y)(\phi^y)''(x) - f_s(x+y, 0)\phi^y(x) = \lambda^y\phi^y(x), & x \in \mathbb{R} \setminus (S-y), \\ \phi^y(x^-) = \phi^y(x^+), (\phi^y)'(x^-) = \sigma(\phi^y)'(x^+), & x = nl - y, \\ \phi^y(x^-) = \phi^y(x^+), \sigma(\phi^y)'(x^-) = (\phi^y)'(x^+), & x = nl + l_2 - y, \\ \phi^y \text{ is periodic, } \phi^y > 0 \text{ in } \mathbb{R}, \|\phi^y\|_{L^\infty(\mathbb{R})} = 1, \end{cases} \quad (6.57)$$

where ϕ^y is continuous in \mathbb{R} and $\phi^y|_{\bar{\mathcal{I}}}$ is of class $C^\infty(\bar{\mathcal{I}})$ for each shifted patch $\mathcal{I} \subset \mathbb{R} \setminus (S-y)$. First of all, it is straightforward to observe:

Lemma 6.14. *The principal eigenvalue λ^y of (6.57) does not depend on y , that is, $\lambda^y = \lambda^0 = \lambda_1$ for all $y \in \mathbb{R}$, where λ_1 is the principal eigenvalue of the eigenvalue problem (6.16).*

Proof. Setting $\phi(x) := \phi^y(x-y)$ for $x \in \mathbb{R}$, the function ϕ satisfies

$$\begin{cases} -d(x)\phi''(x) - f_s(x, 0)\phi(x) = \lambda^y\phi(x), & x \in \mathbb{R} \setminus S, \\ \phi(x^-) = \phi(x^+), \phi'(x^-) = \sigma\phi'(x^+), & x = nl, \\ \phi(x^-) = \phi(x^+), \sigma\phi'(x^-) = \phi'(x^+), & x = nl + l_2, \\ \phi \text{ is periodic, } \phi > 0 \text{ in } \mathbb{R}, \|\phi\|_{L^\infty(\mathbb{R})} = 1. \end{cases}$$

By uniqueness of the principal eigenvalue, one then has $\lambda^y = \lambda^0 = \lambda_1$. □

The second lemma provides a comparison between λ_R^y and λ_1 .

Lemma 6.15. *For all $y \in \mathbb{R}$ and $R > 0$, one has $\lambda_R^y > \lambda_1$.*

Proof. Fix any $y \in \mathbb{R}$ and $R > 0$, and assume by way of contradiction that $\lambda_R^y \leq \lambda_1$. Notice

6. Propagation phenomena in periodic patchy landscapes with interface conditions

that the continuous function φ_R^y satisfies

$$\begin{cases} -d(x+y)(\varphi_R^y)'' - f_s(x+y, 0)\varphi_R^y - \lambda_1\varphi_R^y = (\lambda_R^y - \lambda_1)\varphi_R^y, & \text{in } (-R, R) \setminus (S-y), \\ \varphi_R^y(x^-) = \varphi_R^y(x^+), (\varphi_R^y)'(x^-) = \sigma(\varphi_R^y)'(x^+), & x = nl - y \in (-R, R), \\ \varphi_R^y(x^-) = \varphi_R^y(x^+), \sigma(\varphi_R^y)'(x^-) = (\varphi_R^y)'(x^+), & x = nl + l_2 - y \in (-R, R), \\ \varphi_R^y > 0 \text{ in } (-R, R), \varphi_R^y(\pm R) = 0, \|\varphi_R^y\|_{L^\infty(-R, R)} = 1, \end{cases} \quad (6.58)$$

while the continuous solution $\phi^y = \phi(\cdot + y)$ of (6.57) satisfies

$$\begin{cases} -d(x+y)(\phi^y)'' - f_s(x+y, 0)\phi^y - \lambda_1\phi^y = 0, & \text{in } (-R, R) \setminus (S-y), \\ \phi^y(x^-) = \phi^y(x^+), (\phi^y)'(x^-) = \sigma(\phi^y)'(x^+), & x = nl - y \in (-R, R), \\ \phi^y(x^-) = \phi^y(x^+), \sigma(\phi^y)'(x^-) = (\phi^y)'(x^+), & x = nl + l_2 - y \in (-R, R), \\ \phi^y > 0, & \text{in } [-R, R], \end{cases}$$

where ϕ is the principal eigenfunction of (6.16). Therefore, $\phi^y > \kappa\varphi_R^y$ in $[-R, R]$ for all $\kappa > 0$ small enough. Define

$$\kappa^* = \sup \{ \kappa > 0 : \phi^y > \kappa\varphi_R^y \text{ in } [-R, R] \} \in (0, +\infty).$$

By continuity, $\phi^y \geq \kappa^*\varphi_R^y$ in $[-R, R]$ and there exists $x_0 \in [-R, R]$ such that $\phi^y(x_0) = \kappa^*\varphi_R^y(x_0)$. But since $\phi^y > 0$ in $[-R, R]$ and $\varphi_R^y(\pm R) = 0$, one infers that $x_0 \in (-R, R)$. On the other hand, the function $\kappa^*\varphi_R^y$ satisfies (6.58), hence

$$-d(x+y)(\kappa^*\varphi_R^y)'' - f_s(x+y, 0)\kappa^*\varphi_R^y - \lambda_1\kappa^*\varphi_R^y \leq 0 \text{ in } (-R, R) \setminus (S-y),$$

thanks to the assumption $\lambda_R^y \leq \lambda_1$. It then follows from finitely many applications of the strong elliptic maximum principle and the Hopf lemma that $\kappa^*\varphi_R^y \equiv \phi^y$ in $(-R, R)$ and then in $[-R, R]$ by continuity, a contradiction with the boundary conditions at $x = \pm R$. Consequently, $\lambda_R^y > \lambda_1$ for all $y \in \mathbb{R}$ and $R > 0$. \square

For any two positive real numbers $R_1 < R_2$, by replacing λ_R^y with $\lambda_{R_1}^y$ and λ_1 with $\lambda_{R_2}^y$ in the above proof, and by noticing that $\varphi_{R_2}^y > 0$ in $[-R_1, R_1]$, a similar argument as that of Lemma 6.15 implies that $\lambda_{R_1}^y > \lambda_{R_2}^y$. That is,

Lemma 6.16. *For all $y \in \mathbb{R}$, the function $R \mapsto \lambda_R^y$ is decreasing in $R > 0$.*

The last result before the proof of Proposition 6.13 is the following convergence result.

Lemma 6.17. *One has $\lim_{R \rightarrow +\infty} \lambda_R^y = \lambda_1$ uniformly in $y \in \mathbb{R}$.*

Proof. First of all, from Lemma 6.16 and the periodicity and continuity with respect to y , it is sufficient to show that $\lambda_R^y \rightarrow \lambda_1$ as $R \rightarrow +\infty$ for each $y \in \mathbb{R}$, from Dini's theorem. So let

us fix $y \in \mathbb{R}$ in the proof. For $R > 0$, consider the elliptic operator $\mathcal{L}_R^y u := -d(x+y)u'' - f_s(x+y, 0)u$ with domain

$$E_R = \{ \psi \in H_0^1(-R, R) : \psi|_{\mathcal{I}} \in H^2(\mathcal{I}) \text{ for all } \mathcal{I}, \text{ and } \psi \text{ satisfies the interface conditions in (6.52)} \},$$

where \mathcal{I} is any patch of the type J_s or K_r in $(-R, R) \setminus (S-y)$. Note in particular that the principal eigenfunction φ_R^y of (6.52) belongs to $E_R \setminus \{0\}$. Owing to (6.11), the operator \mathcal{L}_R^y is symmetric with respect to the inner product

$$\langle u, v \rangle_R = \sum_s \int_{J_s} uv + \sum_r \frac{1}{k} \int_{K_r} uv, \quad u, v \in L^2(-R, R).$$

Therefore, one has the following variational formula for λ_R^y :

$$\lambda_R^y = \min_{\psi \in E_R \setminus \{0\}} \frac{B(\psi, \psi) - \Lambda \langle \psi, \psi \rangle_R}{\langle \psi, \psi \rangle_R} = \min_{\psi \in E_R \setminus \{0\}} \frac{\langle \mathcal{L}_R^y \psi, \psi \rangle_R}{\langle \psi, \psi \rangle_R}, \quad (6.59)$$

with Λ and B as in (6.53) and (6.56). It is easy to see that one can choose a family of $C^2(\mathbb{R})$ functions $(\chi_R^y)_{R \geq 2}$, such that $\sup_{R \geq 2} \|\chi_R^y\|_{C^2(\mathbb{R})} < +\infty$ and, for each $R \geq 2$,

$$\begin{cases} \chi_R^y(x) = 1 & \text{for all } x \in [-R+1, R-1], \\ \chi_R^y(x) = 0 & \text{for all } x \in (-\infty, -R] \cup [R, +\infty), \\ (\chi_R^y)'(x) = 0 & \text{for all } x \in S-y, \\ 0 \leq \chi_R^y \leq 1 & \text{in } \mathbb{R}. \end{cases}$$

Let ϕ^y be the solution of (6.57). The function $\psi_R^y := \phi^y \chi_R^y$ belongs to $E_R \setminus \{0\}$ and

$$\frac{\langle \mathcal{L}_R^y \psi_R^y, \psi_R^y \rangle_R}{\langle \psi_R^y, \psi_R^y \rangle_R} = \frac{\langle \mathcal{L}_R^y \phi^y, \phi^y \rangle_{R-1} + D_R}{\langle \psi_R^y, \psi_R^y \rangle_R} = \frac{\lambda_1 \langle \phi^y, \phi^y \rangle_{R-1} + D_R}{\langle \psi_R^y, \psi_R^y \rangle_R}$$

from Lemma 6.14, where

$$\begin{aligned} D_R &= \langle \mathcal{L}_R^y \psi_R^y, \psi_R^y \rangle_R - \langle \mathcal{L}_R^y \phi^y, \phi^y \rangle_{R-1} \\ &= \sum_s \int_{\tilde{J}_s} -d(\cdot+y)(\phi^y \chi_R^y)''(\phi^y \chi_R^y) - f_s(\cdot+y, 0)(\phi^y \chi_R^y)^2 \\ &\quad + \sum_r \frac{1}{k} \int_{\tilde{K}_r} -d(\cdot+y)(\phi^y \chi_R^y)''(\phi^y \chi_R^y) - f_s(\cdot+y, 0)(\phi^y \chi_R^y)^2, \end{aligned}$$

and \tilde{J}_s and \tilde{K}_r stand for the patches of type 1 and 2 in $((-R, -R+1) \cup (R-1, R)) \setminus (S-y)$, that is, $((-R, -R+1) \cup (R-1, R)) \setminus (S-y) = (\cup_s \tilde{J}_s) \cup (\cup_r \tilde{K}_r)$. Since ϕ^y is periodic

6. Propagation phenomena in periodic patchy landscapes with interface conditions

and $\phi^y|_{\bar{\mathcal{I}}} \in C^2(\bar{\mathcal{I}})$ (and even $C^\infty(\bar{\mathcal{I}})$) for each patch $\mathcal{I} \subset \mathbb{R} \setminus (S - y)$, the quantities $\|\phi^y|_{\bar{\mathcal{I}}}\|_{C^2(\bar{\mathcal{I}})}$ are bounded independently of \mathcal{I} . Since $\sup_{R \geq 2} \|\chi_R^y\|_{C^2(\mathbb{R})} < +\infty$, it follows that there exists $C > 0$ such that $|D_R| \leq C$ for all $R \geq 2$. Likewise, one also has

$$\sup_{R \geq 2} |\langle \psi_R^y, \psi_R^y \rangle_R - \langle \phi^y, \phi^y \rangle_{R-1}| < +\infty.$$

On the other hand, since ϕ^y is continuous, positive and periodic, there exists $\delta > 0$ such that $\phi^y \geq \delta > 0$ in \mathbb{R} , hence $\langle \phi^y, \phi^y \rangle_{R-1} \geq 2 \min(1, 1/k) \delta^2 (R-1)$ and

$$\frac{\langle \psi_R^y, \psi_R^y \rangle_R}{\langle \phi^y, \phi^y \rangle_{R-1}} \rightarrow 1 \text{ as } R \rightarrow +\infty.$$

Using the estimates above, one gets that

$$\frac{\langle \mathcal{L}_R^y \psi_R^y, \psi_R^y \rangle_R}{\langle \psi_R^y, \psi_R^y \rangle_R} \rightarrow \lambda_1 \text{ as } R \rightarrow +\infty,$$

and, together with (6.59) and Lemma 6.15, it follows that $\lambda_R^y \rightarrow \lambda_1$ as $R \rightarrow +\infty$. As already emphasized, this provides the desired conclusion. \square

Now we are in a position to give the proof of Proposition 6.13.

Proof of Proposition 6.13. Assume (6.14) and $\lambda_1 < 0$. Let p be a continuous nonnegative bounded solution of the stationary problem (6.17), with $p|_{\bar{I}} \in C^2(\bar{I})$ for each patch I in \mathbb{R} . Assume that $p \not\equiv 0$. By an immediate induction, the strong maximum principle and the Hopf lemma then imply that $p > 0$ in \mathbb{R} . Now, from Lemma 6.17, there is $R > 0$ such that

$$\forall y \in \mathbb{R}, \lambda_R^y < \frac{\lambda_1}{2} < 0, \tag{6.60}$$

where $(\lambda_R^y, \varphi_R^y)$ denotes the eigenpair of (6.52). From (6.14), one can choose $\kappa_0 > 0$ small enough such that, for all $0 < \kappa \leq \kappa_0$ and $y \in \mathbb{R}$,

$$f(x + y, \kappa \varphi_R^y(x)) \geq f_s(x + y, 0) \kappa \varphi_R^y(x) + \frac{\lambda_1}{2} \kappa \varphi_R^y(x) \text{ for all } x \in [-R, R] \setminus (S - y). \tag{6.61}$$

For each $y \in \mathbb{R}$, the function $p^y := p(\cdot + y)$ satisfies

$$\begin{cases} -d(x + y)(p^y)''(x) = f(x + y, p^y(x)), & x \in \mathbb{R} \setminus (S - y), \\ p^y(x^-) = p^y(x^+), (p^y)'(x^-) = \sigma(p^y)'(x^+), & x = nl - y, \\ p^y(x^-) = p^y(x^+), \sigma(p^y)'(x^-) = (p^y)'(x^+), & x = nl + l_2 - y, \end{cases} \tag{6.62}$$

while, for each $\kappa \in (0, \kappa_0]$, the continuous function $\kappa\varphi_R^y$ satisfies

$$\begin{cases} -d(x+y)\kappa(\varphi_R^y)''(x) - f_s(x+y, 0)\kappa\varphi_R^y(x) = \lambda_R^y\kappa\varphi_R^y(x), & \text{in } (-R, R) \setminus (S-y), \\ \kappa\varphi_R^y(x^-) = \kappa\varphi_R^y(x^+), \quad \kappa(\varphi_R^y)'(x^-) = \sigma\kappa(\varphi_R^y)'(x^+), & x = nl - y \in (-R, R), \\ \kappa\varphi_R^y(x^-) = \kappa\varphi_R^y(x^+), \quad \sigma\kappa(\varphi_R^y)'(x^-) = \kappa(\varphi_R^y)'(x^+), & x = nl + l_2 - y \in (-R, R), \\ \kappa\varphi_R^y > 0 \text{ in } (-R, R), \quad \kappa\varphi_R^y(\pm R) = 0. \end{cases} \quad (6.63)$$

It then follows from (6.60)–(6.61) that, for each $\kappa \in (0, \kappa_0]$ and $y \in \mathbb{R}$,

$$-d(x+y)\kappa(\varphi_R^y)''(x) - f(x+y, \kappa\varphi_R^y(x)) \leq \left(\lambda_R^y - \frac{\lambda_1}{2}\right)\kappa\varphi_R^y(x) < 0 \text{ for } x \in (-R, R) \setminus (S-y). \quad (6.64)$$

Let us finally consider any $y \in \mathbb{R}$ and prove that $p^y \geq \kappa_0\varphi_R^y$ in $[-R, R]$. Assuming not and using the continuity and positivity of p^y and the continuity of φ_R^y , one can then define

$$\kappa^* = \sup\{\kappa \in (0, \kappa_0] : p^y \geq \kappa\varphi_R^y \text{ in } [-R, R]\} \in (0, \kappa_0)$$

and one has $p^y \geq \kappa^*\varphi_R^y$ in $[-R, R]$ with equality at a point $x_0 \in [-R, R]$. Since $p^y > 0$ in \mathbb{R} and $\varphi_R^y(\pm R) = 0$, there holds $x_0 \in (-R, R)$. From (6.62)–(6.64) and finitely many applications of the strong maximum principle and the Hopf lemma, one gets that $p^y \equiv \kappa^*\varphi_R^y$ in $(-R, R)$ and then in $[-R, R]$ by continuity, a contradiction with the boundary conditions at $x = \pm R$. As a consequence, $p^y \geq \kappa_0\varphi_R^y$ in $[-R, R]$.

Thus, $p(y) = p^y(0) \geq \kappa_0\varphi_R^y(0)$ for all $y \in \mathbb{R}$. Since the function $y \mapsto \kappa_0\varphi_R^y(0)$ is periodic, continuous and positive, one concludes that $\inf_{\mathbb{R}} p > 0$. \square

Proof of Theorem 6.4. Assume that f satisfies (6.14)–(6.15) and that $\lambda_1 < 0$. Let q and p be two positive bounded solutions of (6.17) (in the sense that q and p are continuous in \mathbb{R} and have restrictions in \bar{I} of class $C^2(\bar{I})$ for each patch $I \subset \mathbb{R}$). Applying Proposition 6.13, there exists $\varepsilon > 0$ such that $q \geq \varepsilon$ and $p \geq \varepsilon$ in \mathbb{R} . One can then define the positive real number

$$\gamma^* = \sup\{\gamma > 0 : q > \gamma p \text{ in } \mathbb{R}\} \in (0, +\infty).$$

We shall prove that $\gamma^* \geq 1$, which will easily yield the conclusion by interchanging the roles of p and q . Assume by way of contradiction that $\gamma^* < 1$, and set $z := q - \gamma^*p \geq 0$. From the definition of γ^* , there exists a sequence $(x_m)_{m \in \mathbb{N}}$ such that $z(x_m) \rightarrow 0$ as $m \rightarrow +\infty$. Moreover, the nonnegative function z is continuous in \mathbb{R} , has restrictions in \bar{I} of class $C^2(\bar{I})$

6. Propagation phenomena in periodic patchy landscapes with interface conditions

for each patch $I \subset \mathbb{R}$, and it satisfies

$$\begin{cases} -d(x)z''(x) - f(x, q(x)) + \gamma^* f(x, p(x)) = 0, & x \in \mathbb{R} \setminus S, \\ z(x^-) = z(x^+), \quad z'(x^-) = \sigma z'(x^+), & x = nl, \\ z(x^-) = z(x^+), \quad \sigma z'(x^-) = z'(x^+), & x = nl + l_2. \end{cases} \quad (6.65)$$

As in the proof of Theorem 6.3, let us assume in (6.15) that $s \mapsto f_1(s)/s$ is decreasing with respect to $s > 0$ (the case when $s \mapsto f_2(s)/s$ is decreasing with respect to $s > 0$ can be handled similarly). Since $\gamma^* \in (0, 1)$ and p is positive in \mathbb{R} , one then has $\gamma^* f(x, p(x)) = \gamma^* f_1(p(x)) < f_1(\gamma^* p(x)) = f(x, \gamma^* p(x))$ for $x \in (nl - l_1, nl)$ and $n \in \mathbb{Z}$, while $\gamma^* f(x, p(x)) = \gamma^* f_2(p(x)) \leq f_2(\gamma^* p(x)) = f(x, \gamma^* p(x))$ for $x \in (nl, nl + l_2)$ and $n \in \mathbb{Z}$. Hence, (6.65) implies that

$$\begin{cases} -d_1 z''(x) - f_1(q(x)) + f_1(\gamma^* p(x)) > 0, & x \in (nl - l_1, nl), \\ -d_2 z''(x) - f_2(q(x)) + f_2(\gamma^* p(x)) \geq 0, & x \in (nl, nl + l_2). \end{cases}$$

Therefore, z satisfies a problem of the type (6.50) for some bounded function b defined in $\mathbb{R} \setminus S$. Hence, as in the proof of Theorem 6.3, if $x_m \rightarrow \bar{x} \in \mathbb{R}$ up to extraction of a subsequence, one gets a contradiction by using the strong maximum principle and the Hopf lemma. In the general case, let $\bar{x}_m \in (-l_1, l_2]$ be such that $x_m - \bar{x}_m \in l\mathbb{Z}$, and let $\bar{x}_\infty \in [-l_1, l_2]$ be such that $\bar{x}_m \rightarrow \bar{x}_\infty$ as $m \rightarrow +\infty$, up to extraction of some subsequence. Next, set $z_m = q_m - \gamma^* p_m$, where $q_m(x) := q(x + x_m - \bar{x}_m)$ and $p_m(x) := p(x + x_m - \bar{x}_m)$. Since $d(x)$ and $f(x, u)$ are periodic with respect to x , it follows from (6.65) that the functions z_m 's satisfy

$$\begin{cases} -d(x)z_m''(x) - f(x, q_m(x)) + \gamma^* f(x, p_m(x)) = 0 & x \in \mathbb{R} \setminus S, \\ z_m(x^-) = z_m(x^+), \quad z_m'(x^-) = \sigma z_m'(x^+), & x = nl, \\ z_m(x^-) = z_m(x^+), \quad \sigma z_m'(x^-) = z_m'(x^+), & x = nl + l_2. \end{cases}$$

The sequences of continuous functions $(q_m)_{m \in \mathbb{N}}$ and $(p_m)_{m \in \mathbb{N}}$ are bounded in $L^\infty(\mathbb{R})$, and then in $C^{2,\nu}(\bar{I})$ for each $\nu \in (0, 1)$ and each patch $I \subset \mathbb{R}$ from standard elliptic estimates. Thus, there exist three continuous functions $q_\infty \geq \varepsilon$, $p_\infty \geq \varepsilon$ and $z_\infty = q_\infty - \gamma^* p_\infty \geq 0$ such that, up to extraction of some subsequence, $(q_m|_{\bar{I}}, p_m|_{\bar{I}}, z_m|_{\bar{I}}) \rightarrow (q_\infty|_{\bar{I}}, p_\infty|_{\bar{I}}, z_\infty|_{\bar{I}})$ in $C^2(\bar{I})$ as $m \rightarrow +\infty$ for each patch $I \subset \mathbb{R}$. Furthermore,

$$\begin{cases} -d(x)z_\infty''(x) - f(x, q_\infty(x)) + \gamma^* f(x, p_\infty(x)) = 0, & x \in \mathbb{R} \setminus S, \\ z_\infty(x^-) = z_\infty(x^+), \quad z_\infty'(x^-) = \sigma z_\infty'(x^+), & x = nl, \\ z_\infty(x^-) = z_\infty(x^+), \quad \sigma z_\infty'(x^-) = z_\infty'(x^+), & x = nl + l_2, \end{cases}$$

and $z_\infty \geq 0$ in \mathbb{R} with $z_\infty(\bar{x}_\infty) = 0$. Using the positivity of p_∞ and the same argument as for problem (6.65) above, one reaches a contradiction.

Consequently, $\gamma^* \geq 1$, whence $q \geq p$ in \mathbb{R} . By interchanging the roles of q and p , one also gets $p \geq q$ in \mathbb{R} . The uniqueness is therefore obtained. Furthermore, if p is a positive solution of (6.17), so is the function $x \mapsto p(x+l)$. This implies that p is periodic. The proof of Theorem 6.4 is thereby complete. \square

6.5 Long-time behavior: proof of Theorem 6.5

This section is devoted to the proof of Theorem 6.5 on the large-time behavior of the solutions of the evolution problem (6.12)–(6.13).

Proof of Theorem 6.5. Assume that f satisfies (6.14)–(6.15). Let u be the solution, given in Theorem 6.2, of the Cauchy problem (6.12)–(6.13) with a nonnegative, bounded and continuous initial datum $u_0 \not\equiv 0$. We know from Theorem 6.2 that u is continuous in $[0, +\infty) \times \mathbb{R}$ and positive in $(0, +\infty) \times \mathbb{R}$.

(i) Assume that 0 is an unstable solution of (6.17), that is, $\lambda_1 < 0$, and let p be the unique positive bounded and periodic solution of (6.17) given by Theorem 6.3 (i) and Theorem 6.4. The function p is continuous in \mathbb{R} and has restriction in \bar{I} of class $C^2(\bar{I})$ for each patch $I \subset \mathbb{R}$. With the notations of Section 6.4.2 and from Lemma 6.17, one can fix $R > 0$ large enough so that $\lambda_R^0 < \lambda_1/2 < 0$ and (6.63)–(6.64) hold with $y = 0$ for all $\kappa > 0$ small enough, where $(\lambda_R^0, \varphi_R^0)$ denotes the unique eigenpair solving (6.52) with $y = 0$:

$$\begin{cases} -d(x)(\varphi_R^0)''(x) - f_s(x, 0)\varphi_R^0(x) = \lambda_R^0\varphi_R^0(x), & x \in (-R, R) \setminus S, \\ \varphi_R^0(x^-) = \varphi_R^0(x^+), (\varphi_R^0)'(x^-) = \sigma(\varphi_R^0)'(x^+), & x = nl \in (-R, R), \\ \varphi_R^0(x^-) = \varphi_R^0(x^+), \sigma(\varphi_R^0)'(x^-) = (\varphi_R^0)'(x^+), & x = nl + l_2 \in (-R, R), \\ \varphi_R^0 > 0 \text{ in } (-R, R), \varphi_R^0(\pm R) = 0, \|\varphi_R^0\|_{L^\infty(-R, R)} = 1. \end{cases}$$

From the continuity and positivity of p and $u(1, \cdot)$ in \mathbb{R} , one can fix $\kappa > 0$ small enough so that (6.63)–(6.64) hold with $y = 0$, together with $\kappa\varphi_R^0 < p$ and $\kappa\varphi_R^0 < u(1, \cdot)$ in $[-R, R]$.

Define now a function v_0 in \mathbb{R} by

$$v_0(x) = \begin{cases} \kappa\varphi_R^0(x) & \text{for } x \in [-R, R], \\ 0 & \text{for } x \in \mathbb{R} \setminus [-R, R]. \end{cases}$$

The function v_0 is nonnegative, continuous and bounded in \mathbb{R} , with $v_0 \not\equiv 0$ in \mathbb{R} . Let v be the solution of the Cauchy problem (6.12)–(6.13) with initial datum v_0 , given by Theorem 6.2. For each $n \in \mathbb{N}$, let v^n (respectively u^n) be the unique bounded classical solution of (6.21)–(6.24) with initial condition $v^n(0, \cdot) = \delta^n v_0|_{[-nl, nl]}$ (respectively $u^n(0, \cdot) = \delta^n u_0|_{[-nl, nl]}$), with the cut-off function δ^n given in (6.40). From Theorem 6.2, the sequence $(v^n)_{n \in \mathbb{N}}$ (respectively $(u^n)_{n \in \mathbb{N}}$) converges monotonically pointwise in $[0, +\infty) \times \mathbb{R}$ to the function v (respectively u). For

6. Propagation phenomena in periodic patchy landscapes with interface conditions

each $n \in \mathbb{N}$, there holds $0 \leq v^n(0, \cdot) \leq v_0 \leq p$ in $[-nl, nl]$, hence $0 \leq v^n(t, x) \leq p(x)$ for all $(t, x) \in [0, +\infty) \times [-nl, nl]$ by Proposition 6.23, and

$$0 \leq v(t, x) \leq p(x) \quad \text{for all } (t, x) \in [0, +\infty) \times \mathbb{R}$$

by passing to the limit $n \rightarrow +\infty$ (actually, we also know from Theorem 6.2 that $v > 0$ in $(0, +\infty) \times \mathbb{R}$). Furthermore, for each $n \geq R/l + 1$, since $v^n(t, \pm R) \geq 0$ for all $t \geq 0$ and since

$$v^n(0, \cdot)|_{[-R, R]} = \delta^n v_0|_{[-R, R]} = v_0|_{[-R, R]} = \kappa \varphi_R^0$$

with $\kappa \varphi_R^0$ satisfying (6.63)–(6.64), Proposition 6.23 again implies that

$$v^n(t, x) \geq \kappa \varphi_R^0(x) \quad \text{for all } (t, x) \in [0, +\infty) \times [-R, R].$$

Together with the nonnegativity of v^n in $[0, +\infty) \times [-nl, nl]$ and the definition of v_0 , this yields

$$v^n(h, x) \geq v_0(x) \geq v^n(0, x) \quad \text{for all } x \in [-nl, nl] \text{ and } h \geq 0,$$

hence $v^n(t + h, x) \geq v^n(t, x)$ for all $(t, x) \in [0, +\infty) \times [-nl, nl]$ and $h \geq 0$, and finally $v(t + h, x) \geq v(t, x)$ for all $(t, x) \in [0, +\infty) \times \mathbb{R}$ and $h \geq 0$. Therefore, the function v is non-decreasing in t . Since it is positive in $(0, +\infty)$ and since $v(t, x) \leq p(x)$ for all $(t, x) \in [0, +\infty) \times \mathbb{R}$, the Schauder estimates of Theorem 6.2 yield the existence of a positive bounded solution q of (6.17) such that $v(t, \cdot) \rightarrow q$ as $t \rightarrow +\infty$ locally uniformly in \mathbb{R} and $v(t, \cdot)|_{\bar{I}} \rightarrow q|_{\bar{I}}$ as $t \rightarrow +\infty$ in $C^2(\bar{I})$ for each patch $I \subset \mathbb{R}$. It follows from Theorem 6.4 that $q \equiv p$ in \mathbb{R} . In other words,

$$v(t, \cdot) \xrightarrow[t \rightarrow +\infty]{} p \quad \text{locally uniformly in } \mathbb{R} \quad \text{and} \quad v(t, \cdot)|_{\bar{I}} \xrightarrow[t \rightarrow +\infty]{} p|_{\bar{I}} \quad \text{in } C^2(\bar{I}) \quad \text{for each patch } I \subset \mathbb{R}. \quad (6.66)$$

On the other hand, since the continuous functions $\kappa \varphi_R^0$ and $u(1, \cdot)$ satisfy $\kappa \varphi_R^0 < u(1, \cdot)$ in $[-R, R]$ and since $u^n(1, \cdot) \rightarrow u(1, \cdot)$ locally uniformly in \mathbb{R} as $n \rightarrow +\infty$, there is $n_0 \geq R/l$ such that $\kappa \varphi_R^0(x) \leq u^n(1, x)$ for all $x \in [-R, R]$ and for all $n \geq n_0$. Since $u^n \geq 0$ in $[0, +\infty) \times [-nl, nl]$, it follows that $v^n(0, x) \leq v_0(x) \leq u^n(1, x)$ for all $x \in [-nl, nl]$ and for all $n \geq n_0$, hence $v^n(t, x) \leq u^n(t + 1, x)$ for all $(t, x) \in [0, +\infty) \times [-nl, nl]$ and for all $n \geq n_0$, by Proposition 6.23. Therefore,

$$v(t, x) \leq u(t + 1, x) \quad \text{for all } (t, x) \in [0, +\infty) \times \mathbb{R}. \quad (6.67)$$

Lastly, define $M_1 := \max(M, \|u_0\|_{L^\infty(\mathbb{R})})$ with $M > 0$ as in (6.14). As in the proof of Theorem 6.3 (i), the solution w (given by Theorem 6.2) of the Cauchy problem (6.12)–(6.13) with initial datum M_1 , is non-increasing in t , periodic in x , and converges as $t \rightarrow +\infty$

uniformly in \mathbb{R} to a nonnegative periodic bounded solution \bar{p} of (6.17). Furthermore,

$$0 \leq u(t, x) \leq w(t, x) \quad \text{for all } (t, x) \in [0, +\infty) \times \mathbb{R} \quad (6.68)$$

by Theorem 6.2. Together with (6.66)–(6.67), one infers that $\bar{p} \geq p (> 0)$ in \mathbb{R} , and then $\bar{p} \equiv p$ by Theorem 6.4. Since $v(t, x) \leq u(t+1, x) \leq w(t+1, x)$ for all $(t, x) \in [0, +\infty) \times \mathbb{R}$, one then concludes that $u(t, \cdot) \rightarrow p$ as $t \rightarrow +\infty$ locally uniformly in \mathbb{R} , and together with the Schauder estimates of Theorem 6.2, that $u(t, \cdot)|_{\bar{I}} \rightarrow p|_{\bar{I}}$ as $t \rightarrow +\infty$ in $C^2(\bar{I})$ for each patch $I \subset \mathbb{R}$.

(ii) Let us now assume that 0 is a stable solution of (6.17), that is, $\lambda_1 \geq 0$. By defining w and \bar{p} as in the previous paragraph (the definitions of w and \bar{p} did not use the stability properties of 0), Theorem 6.3 (ii) then yields $\bar{p} \equiv 0$ in \mathbb{R} . Together with (6.68) and the uniform convergence $w(t, \cdot) \rightarrow \bar{p} = 0$ in \mathbb{R} as $t \rightarrow +\infty$, one concludes that $u(t, \cdot) \rightarrow 0$ as $t \rightarrow +\infty$ uniformly in \mathbb{R} . The proof of Theorem 6.5 is thereby complete. \square

An immediate corollary of Theorem 6.5, which will be used in the proofs of Theorems 6.6 and 6.8 in Section 6.6, is the following result.

Corollary 6.18. *Assume that f satisfies (6.14)–(6.15) and that 0 is an unstable solution of (6.17) (i.e., $\lambda_1 < 0$). Let p be the unique positive bounded and periodic solution of (6.17) given by Theorem 6.3 (i) and Theorem 6.4. Let u denote the solution of the Cauchy problem (6.12)–(6.13) with a nonnegative bounded and continuous initial datum $u_0 \not\equiv 0$. If u_0 is periodic, then $u(t, \cdot) \rightarrow p$ as $t \rightarrow +\infty$ uniformly in \mathbb{R} .*

Proof. We already know from Theorem 6.2 that, for each $t \geq 0$, the function $x \mapsto u(t, x)$ is periodic. Since $u(t, \cdot) \rightarrow p$ as $t \rightarrow +\infty$ locally uniformly in \mathbb{R} by Theorem 6.5, the conclusion follows. \square

6.6 Spreading speeds and periodic traveling waves: proofs of Theorems 6.6 and 6.8

This section is devoted to the study of the spatial dynamics of the problem (6.12)–(6.13). We will prove the existence of an asymptotic spreading speed c^* , which can be given explicitly by a variational formula using principal eigenvalues of certain linear operators. Moreover, the spreading speed coincides with the minimal speed for pulsating traveling waves. The main approach is based on the abstract dynamical systems theory for monostable evolution systems established in the seminal work in [155] and further developed in [113, 114].

Hereafter we assume that the 0 solution of (6.17) is unstable (i.e., $\lambda_1 < 0$) and that f satisfies (6.14)–(6.15). By Theorem 6.3 (i) and Theorem 6.4, there exists a unique positive bounded periodic solution p of (6.17). We point out that, with these hypotheses, populations

6. Propagation phenomena in periodic patchy landscapes with interface conditions

starting with any bounded nonnegative and non-trivial initial condition always persist, by Theorem 6.5. Using the notations of [114, Section 5], we define $\mathcal{H} = \mathbb{R}$, $\tilde{\mathcal{H}} = l\mathbb{Z}$, $X = Y = \mathbb{R}$, $\beta = p$ and $\mathcal{M} = \mathcal{C}_p$, with \mathcal{C}_p given in (6.20). We also define a family of maps $\{Q_t\}_{t \geq 0}$ in \mathcal{C}_p by

$$Q_t(\omega)(x) = u(t, x; \omega) \text{ for } \omega \in \mathcal{C}_p, t \geq 0, \text{ and } x \in \mathbb{R}, \quad (6.69)$$

where $(t, x) \mapsto u(t, x; \omega)$ denotes the classical solution to the Cauchy problem (6.12)–(6.13) with initial condition $u(0, \cdot; \omega) = \omega \in \mathcal{C}_p$, given by Theorem 6.2. In particular, $Q_0(\omega) = \omega$ for every $\omega \in \mathcal{C}_p$, and $Q_t(0) = 0$ for every $t \geq 0$. Furthermore, since the continuous positive function p solves (6.17) and since $u(t, \cdot; p)$ is periodic for every $t \geq 0$ by Theorem 6.2, it follows with similar arguments as in Proposition 6.23 (but this time in the class of periodic solutions) that $u(t, \cdot; p) = p$ for each $t \geq 0$, that is, $Q_t(p) = p$. Theorem 6.2 then implies that $u(t, \cdot; \omega) \in \mathcal{C}_p$ for every $\omega \in \mathcal{C}_p$ and $t \geq 0$. In other words, for every $t \geq 0$, Q_t maps \mathcal{C}_p into itself.

We recall that a family of maps $\{Q_t\}_{t \geq 0}$ from \mathcal{C}_p into itself is said to be a semiflow in \mathcal{C}_p if it satisfies the following properties:

- (1) $Q_0(\omega) = \omega$ for all $\omega \in \mathcal{C}_p$;
- (2) $Q_{t_1}(Q_{t_2}(\omega)) = Q_{t_1+t_2}(\omega)$ for all $t_1, t_2 \geq 0$ and for all $\omega \in \mathcal{C}_p$;
- (3) the map $(t, \omega) \mapsto Q_t(\omega)$ is continuous from $[0, +\infty) \times \mathcal{C}_p$ into \mathcal{C}_p , with \mathcal{C}_p equipped with the compact open topology, that is, $Q_{t_m}(\omega_m) \rightarrow Q_t(\omega)$ as $m \rightarrow +\infty$ locally uniformly in \mathbb{R} if $t_m \rightarrow t$ and $\omega_m \rightarrow \omega$ locally uniformly in \mathbb{R} as $m \rightarrow +\infty$, with $(t_m, \omega_m) \in [0, +\infty) \times \mathcal{C}_p$.

We also say that $\{Q_t\}_{t \geq 0}$ is monotone in \mathcal{C}_p if, for every $t \geq 0$, $Q_t(\omega) \geq Q_t(\omega')$ in \mathbb{R} provided $\omega \geq \omega'$ in \mathbb{R} , with $\omega, \omega' \in \mathcal{C}_p$. Lastly, $\{Q_t\}_{t \geq 0}$ is called subhomogeneous if $\gamma Q_t(\omega) \leq Q_t(\gamma\omega)$ in \mathbb{R} for every $t \geq 0$, $\gamma \in [0, 1]$, and $\omega \in \mathcal{C}_p$.

The following proposition summarizes the properties of the family $\{Q_t\}_{t \geq 0}$ defined in (6.69).

Proposition 6.19. *The family $\{Q_t\}_{t \geq 0}$ defined in (6.69) is a monotone and subhomogeneous semiflow in \mathcal{C}_p . Furthermore, for every $\omega \in \mathcal{C}_p$, $a \in l\mathbb{Z}$, $t \geq 0$ and $x \in \mathbb{R}$, there holds $Q_t(\omega(\cdot + a))(x) = Q_t(\omega)(x + a)$.*

Proof. First of all, the property $Q_0(\omega) = \omega$ is already known by definition, and the monotonicity of $\{Q_t\}_{t \geq 0}$ follows from Theorem 6.2.

For the proof of the other properties, we consider a sequence $(\delta^n)_{n \in \mathbb{N}}$ of continuous cut-off functions satisfying (6.40). Throughout the proof, for any $\omega \in \mathcal{C}_p$ and $n \in \mathbb{N}$, we denote by $(t, x) \mapsto u^n(t, x; \omega)$ the unique continuous solution of the truncated problem (6.21)–(6.24) in $[0, +\infty) \times [-nl, nl]$ with initial condition $u^n(0, \cdot; \omega) = \delta^n \omega|_{[-nl, nl]}$. We know from the proof of Theorem 6.2 that, for each $(t, x) \in [0, +\infty) \times \mathbb{R}$, the sequence $(u^n(t, x; \omega))_{n \geq |x|/l}$

6.6. Spreading speeds and periodic traveling waves: proofs of Theorems 6.6 and 6.8

is nonnegative, nondecreasing and converges to $u(t, x; \omega)$ (and the convergence holds locally uniformly with respect to $(t, x) \in [0, +\infty) \times \mathbb{R}$).

Let us first show that $Q_{t_1}(Q_{t_2}(\omega)) = Q_{t_1+t_2}(\omega)$ for all $t_1, t_2 \geq 0$ and for all $\omega \in \mathcal{C}_p$. The conclusion holds trivially when t_1 or t_2 is equal to 0, or when $\omega \equiv 0$ in \mathbb{R} . So, let us assume that $t_1 > 0$, $t_2 > 0$ and $\omega \in \mathcal{C}_p$ with $\omega \not\equiv 0$ in \mathbb{R} . Call $\omega_2 = u(t_2, \cdot; \omega)$. For each $n \in \mathbb{N}$, one has

$$u^n(t_2, x; \omega) \leq u(t_2, x; \omega) = \omega_2(x) = \delta^{n+1}(x)\omega_2(x) = u^{n+1}(0, x; \omega_2) \text{ for all } x \in [-nl, nl],$$

and $u^n(t_2+t, \pm nl; \omega) = 0 \leq u^{n+1}(t, \pm nl; \omega_2)$ for all $t \geq 0$. Hence, Proposition 6.23 implies that $u^n(t_2+t, x; \omega) \leq u^{n+1}(t, x; \omega_2)$ for all $t \geq 0$ and $x \in [-nl, nl]$, hence $u(t_2+t, x; \omega) \leq u(t, x; \omega_2)$ for all $(t, x) \in [0, +\infty) \times \mathbb{R}$. In particular,

$$Q_{t_2+t_1}(\omega)(x) \leq Q_{t_1}(\omega_2)(x) = Q_{t_1}(Q_{t_2}(\omega))(x) \text{ for all } x \in \mathbb{R}. \quad (6.70)$$

To show the reverse inequality, consider any $\eta \in (0, 1)$ and $m \in \mathbb{N}$. Since $u^n(t_2, \cdot; \omega) \rightarrow u(t_2, \cdot; \omega) = \omega_2$ as $n \rightarrow +\infty$ locally uniformly in \mathbb{R} and since the continuous function ω_2 is positive in \mathbb{R} by Theorem 6.2 (we here use $\omega \geq \not\equiv 0$ in \mathbb{R} and the positivity of t_2), there is an integer $n_{\eta, m} \geq m$ such that

$$u^n(t_2, x; \omega) \geq \eta u(t_2, x; \omega) = \eta \omega_2(x) \geq u^m(0, x; \eta \omega_2) \text{ for all } x \in [-ml, ml] \text{ and } n > n_{\eta, m},$$

while $u^n(t_2+t, \pm ml; \omega) > 0 = u^m(t, \pm ml; \eta \omega_2)$ for all $t \geq 0$. Therefore, Proposition 6.23 implies that

$$u^n(t_2+t, x; \omega) \geq u^m(t, x; \eta \omega_2) \text{ for all } t \geq 0, x \in [-ml, ml], \text{ and } n \geq n_{\eta, m},$$

hence $u(t_2+t, x; \omega) \geq u^m(t, x; \eta \omega_2)$ for all $t \geq 0$ and $x \in [-ml, ml]$. Since $m \in \mathbb{N}$ was arbitrary, one gets that $u(t_2+t, x; \omega) \geq u(t, x; \eta \omega_2)$ for all $(t, x) \in [0, +\infty) \times \mathbb{R}$. Lastly, since from Theorem 6.2 the map $\eta \mapsto u(t_1, \cdot; \eta \omega_2)$ is continuous from $[0, 1]$ to the set of continuous bounded functions with the sup norm, one concludes that $u(t_2+t_1, x; \omega) \geq u(t_1, x; \omega_2)$ for all $x \in \mathbb{R}$, that is, $Q_{t_2+t_1}(\omega)(x) \geq Q_{t_1}(\omega_2)(x) = Q_{t_1}(Q_{t_2}(\omega))(x)$ for all $x \in \mathbb{R}$. Together with (6.70), this yields the desired property $Q_{t_2+t_1}(\omega) = Q_{t_1}(Q_{t_2}(\omega))$ in \mathbb{R} .

To show the continuity property, consider any $(t, \omega) \in [0, +\infty) \times \mathcal{C}_p$ and any sequence $(t_m, \omega_m)_{m \in \mathbb{N}}$ in $[0, +\infty) \times \mathcal{C}_p$ such that $t_m \rightarrow t$ and $\omega_m \rightarrow \omega$ locally uniformly in \mathbb{R} as $m \rightarrow +\infty$. One has to show that $u(t_m, \cdot; \omega_m) \rightarrow u(t, \cdot; \omega)$ locally uniformly in \mathbb{R} as $m \rightarrow +\infty$. Let $T \in (0, +\infty)$ be such that $0 \leq t \leq T$ and $0 \leq t_m \leq T$ for all $m \in \mathbb{N}$. Take any $A > 0$, and let $\varepsilon > 0$ be arbitrary. There is a function $\bar{\omega} \in \mathcal{C}_p \cap C^3(\mathbb{R})$ such that $\|\bar{\omega}\|_{C^3(\mathbb{R})} < +\infty$,

6. Propagation phenomena in periodic patchy landscapes with interface conditions

$\bar{\omega}' = 0$ at all points of S , and $\|\bar{\omega} - \omega\|_{L^\infty(\mathbb{R})} \leq \varepsilon/2$. For $m \in \mathbb{N}$, define $\bar{\omega}_m : \mathbb{R} \rightarrow \mathbb{R}$ by

$$\bar{\omega}_m = \min \left(\max(\bar{\omega}, \omega_m - \varepsilon), \omega_m + \varepsilon \right),$$

that is, $\bar{\omega}_m(x) = \bar{\omega}(x)$ if $\omega_m(x) - \varepsilon \leq \bar{\omega}(x) \leq \omega_m(x) + \varepsilon$, $\bar{\omega}_m(x) = \omega_m(x) + \varepsilon$ if $\bar{\omega}(x) > \omega_m(x) + \varepsilon$, and $\bar{\omega}_m(x) = \omega_m(x) - \varepsilon$ if $\bar{\omega}(x) < \omega_m(x) - \varepsilon$. Each function $\bar{\omega}_m$ belongs to \mathcal{C}_p , and $\|\bar{\omega}_m - \omega_m\|_{L^\infty(\mathbb{R})} \leq \varepsilon$. Furthermore, since $\|\bar{\omega} - \omega\|_{L^\infty(\mathbb{R})} \leq \varepsilon/2$ and $\omega_m \rightarrow \omega$ as $m \rightarrow +\infty$ locally uniformly in \mathbb{R} , one infers that, for each compact set $\mathcal{K} \subset \mathbb{R}$, one has

$$\bar{\omega}_m|_{\mathcal{K}} = \bar{\omega}|_{\mathcal{K}} \quad \text{for all } m \text{ large enough.} \quad (6.71)$$

As $\|\bar{\omega}\|_{C^3(\mathbb{R})}$ is finite and $0 \leq u(t, x; \omega_m) \leq p(x)$ for all $(t, x) \in [0, +\infty) \times \mathbb{R}$ and $m \in \mathbb{N}$, standard parabolic estimates yield the existence of a positive constant C_1 such that, for each patch $I = (a, b) \subset \mathbb{R}$, the functions $t \mapsto u(t, (a+b)/2; \bar{\omega}_m)$ belong to $C^{1,1/4}([0, +\infty))$ for all m large enough, and $\|u(\cdot, (a+b)/2; \bar{\omega}_m)\|_{C^{1,1/4}([0, +\infty))} \leq C_1$. As in the proof of Theorem 6.2, and using here the fact that $\bar{\omega}$ is bounded in $C^3(\mathbb{R})$ and $\bar{\omega}'$ vanishes on S , it then follows that there are $\theta \in (0, 1)$ and a positive constant C_2 such that, for each patch $I \subset \mathbb{R}$ and from the above estimates applied at the middle points of the leftward and rightward adjacent patches, the functions $u(\cdot, \cdot; \bar{\omega}_m)|_{[0, +\infty) \times \bar{I}}$ belong to $C_{t;x}^{1,\theta;2,\theta}([0, +\infty) \times \bar{I})$ and

$$\|u(\cdot, \cdot; \bar{\omega}_m)|_{[0, +\infty) \times \bar{I}}\|_{C_{t;x}^{1,\theta;2,\theta}([0, +\infty) \times \bar{I})} \leq C_2$$

for all m large enough. Up to extraction of a subsequence, the continuous functions $u(\cdot, \cdot; \bar{\omega}_m)$ converge as $m \rightarrow +\infty$ locally uniformly in $[0, +\infty) \times \mathbb{R}$ to a continuous function \bar{U} such that, for each patch $I \subset \mathbb{R}$, $\bar{U}|_{[0, +\infty) \times \bar{I}} \in C_{t;x}^{1,\theta;2,\theta}([0, +\infty) \times \bar{I})$, $\|\bar{U}|_{[0, +\infty) \times \bar{I}}\|_{C_{t;x}^{1,\theta;2,\theta}([0, +\infty) \times \bar{I})} \leq C_2$, and, for every $\tau > 0$, $u(\cdot, \cdot; \bar{\omega}_m)|_{[0, \tau] \times \bar{I}} \rightarrow \bar{U}|_{[0, \tau] \times \bar{I}}$ as $m \rightarrow +\infty$ in $C_{t;x}^{1;2}([0, \tau] \times \bar{I})$. Notice that $\bar{U}(0, \cdot) = \bar{\omega}$ from the above limits and (6.71). On the other hand, similarly, there is a positive constant C'_1 such that, for each patch $I = (a, b) \subset \mathbb{R}$, the function $t \mapsto u^n(t, (a+b)/2; \bar{\omega})$ belongs to $C^{1,1/4}([0, +\infty))$ and $\|u^n(\cdot, (a+b)/2; \bar{\omega})\|_{C^{1,1/4}([0, +\infty))} \leq C'_1$ for all n large enough. As above, there is then a positive constant C'_2 such that, for each patch $I \subset \mathbb{R}$, $u^n(\cdot, \cdot; \bar{\omega})|_{[0, +\infty) \times \bar{I}}$ belongs to $C_{t;x}^{1,\theta;2,\theta}([0, +\infty) \times \bar{I})$ and $\|u^n(\cdot, \cdot; \bar{\omega})|_{[0, +\infty) \times \bar{I}}\|_{C_{t;x}^{1,\theta;2,\theta}([0, +\infty) \times \bar{I})} \leq C'_2$ for all n large enough. Therefore, for each patch $I \subset \mathbb{R}$, the restriction to $[0, +\infty) \times \bar{I}$ of the limit function $u(\cdot, \cdot; \bar{\omega})$ belongs to $C_{t;x}^{1,\theta;2,\theta}([0, +\infty) \times \bar{I})$ and

$$\|u(\cdot, \cdot; \bar{\omega})|_{[0, +\infty) \times \bar{I}}\|_{C_{t;x}^{1,\theta;2,\theta}([0, +\infty) \times \bar{I})} \leq C'_2.$$

Since $u(0, \cdot; \bar{\omega}) = \bar{\omega} = \bar{U}(0, \cdot)$, Proposition 6.25 then implies that $u(\cdot, \cdot; \bar{\omega}) \equiv \bar{U}$ in $[0, +\infty) \times \mathbb{R}$. Therefore, since the limit of any subsequence of $(u(\cdot, \cdot; \bar{\omega}_m))_{m \in \mathbb{N}}$ is unique, one gets that the whole sequence $(u(\cdot, \cdot; \bar{\omega}_m))_{m \in \mathbb{N}}$ converges locally uniformly in $[0, +\infty) \times \mathbb{R}$ to $u(\cdot, \cdot; \bar{\omega})$. In

6.6. Spreading speeds and periodic traveling waves: proofs of Theorems 6.6 and 6.8

particular, there is m_0 such that

$$\max_{[0,T] \times [-A,A]} |u(\cdot, \cdot; \bar{\omega}_m) - u(\cdot, \cdot; \bar{\omega})| \leq \varepsilon \quad \text{for all } m \geq m_0.$$

Finally, since $\|\bar{\omega} - \omega\|_{L^\infty(\mathbb{R})} \leq \varepsilon/2$ and $\|\bar{\omega}_m - \omega_m\|_{L^\infty(\mathbb{R})} \leq \varepsilon$ for each m , formula (6.47) of the proof of Theorem 6.2 yields $\|u(\cdot, \cdot; \bar{\omega}) - u(\cdot, \cdot; \omega)\|_{L^\infty([0,T] \times \mathbb{R})} \leq \varepsilon e^{LT}$ and $\|u(\cdot, \cdot; \bar{\omega}_m) - u(\cdot, \cdot; \omega_m)\|_{L^\infty([0,T] \times \mathbb{R})} \leq 2\varepsilon e^{LT}$, with $L := \max(\|f'_1\|_{L^\infty([0,\bar{K}])}, \|f'_2\|_{L^\infty([0,\bar{K}])})$ and $\bar{K} := \max(K_1, K_2, \|p\|_{L^\infty(\mathbb{R})})$. One infers that

$$\max_{[0,T] \times [-A,A]} |u(\cdot, \cdot; \omega_m) - u(\cdot, \cdot; \omega)| \leq \varepsilon \left(1 + 3e^{LT}\right)$$

for all $m \geq m_0$. Since $\varepsilon > 0$ was arbitrary and $u(\cdot, \cdot; \omega)$ is continuous in $[0, +\infty) \times \mathbb{R}$, this shows that $u(t_m, \cdot; \omega_m) \rightarrow u(t, \cdot; \omega)$ uniformly in $[-A, A]$ as $m \rightarrow +\infty$, leading to the desired result.

Let us now show that the family $\{Q_t\}_{t \geq 0}$ is subhomogeneous. So, let us consider any $\gamma \in [0, 1]$ and $\omega \in \mathcal{C}_p$, and let us show that $\gamma Q_t(\omega) \leq Q_t(\gamma\omega)$ in \mathbb{R} for all $t \geq 0$. From (6.15), it follows that, for every $n \in \mathbb{N}$, $\gamma f(x, u^n(t, x; \omega)) \leq f(x, \gamma u^n(t, x; \omega))$ for all $(t, x) \in [0, +\infty) \times ((-nl, nl) \setminus S)$, hence $\gamma u^n(\cdot, \cdot; \omega)$ is a subsolution of the problem satisfied by $u^n(\cdot, \cdot; \gamma\omega)$ in $[0, +\infty) \times [-nl, nl]$ (with the same initial condition in $[-nl, nl]$). Proposition 6.23 implies that $\gamma u^n(t, x; \omega) \leq u^n(t, x; \gamma\omega)$ for all $n \in \mathbb{N}$ and $(t, x) \in [0, +\infty) \times [-nl, nl]$, and thus $\gamma u(t, x; \omega) \leq u(t, x; \gamma\omega)$ for all $(t, x) \in [0, +\infty) \times \mathbb{R}$, that is, $\gamma Q_t(\omega) \leq Q_t(\gamma\omega)$ in \mathbb{R} for all $t \geq 0$.

Finally, consider any $\omega \in \mathcal{C}_p$ and $a \in l\mathbb{Z}$. Set $\omega_a = \omega(\cdot + a)$. For every $n \in \mathbb{N}$ and $x \in [-nl, nl]$, one has $\delta^{n+|a|/l+1}(x+a) = 1$, hence

$$u^n(0, x; \omega_a) = \delta^n(x)\omega(x+a) \leq \omega(x+a) = \delta^{n+|a|/l+1}(x+a)\omega(x+a) = u^{n+|a|/l+1}(0, x+a; \omega).$$

Furthermore, $u^n(t, \pm nl; \omega_a) = 0 \leq u^{n+|a|/l+1}(t, \pm nl + a; \omega)$ for all $t \geq 0$, and the function $[0, +\infty) \times [-nl, nl] \ni (t, x) \mapsto u^{n+|a|/l+1}(t, x+a; \omega)$ satisfies the same partial differential equations as $u^n(\cdot, \cdot; \omega_a)$, as well as the same interface conditions, due to the periodicity of $d(x)$ and $f(x, s)$ with respect to x . Proposition 6.23 then implies that $u^n(t, x; \omega_a) \leq u^{n+|a|/l+1}(t, x+a; \omega)$ for all $n \in \mathbb{N}$ and $(t, x) \in [0, +\infty) \times [-nl, nl]$, hence

$$u(t, x; \omega_a) \leq u(t, x+a; \omega) \quad \text{for all } (t, x) \in [0, +\infty) \times \mathbb{R}.$$

Since this property is valid for every $a \in l\mathbb{Z}$ and $\omega \in \mathcal{C}_p$, one also gets that

$$u(t, x+a; \omega) = u(t, x+a; (\omega_a)_{-a}) \leq u(t, (x+a) - a; \omega_a) = u(t, x; \omega_a)$$

for every $a \in l\mathbb{Z}$, $\omega \in \mathcal{C}_p$ and $(t, x) \in [0, +\infty) \times \mathbb{R}$, and finally $u(t, x; \omega_a) = u(t, x+a; \omega)$ for all $(t, x) \in [0, +\infty) \times \mathbb{R}$. This completes the proof of Proposition 6.19. \square

6. Propagation phenomena in periodic patchy landscapes with interface conditions

As a consequence of Theorem 6.2 and Proposition 6.19, we conclude that the solution maps $Q_t : \mathcal{C}_p \rightarrow \mathcal{C}_p$ satisfy the following properties:

- (E1) for each $t \geq 0$, Q_t is periodic, that is, $Q_t(T_a(\omega)) = T_a(Q_t(\omega))$ for all $a \in l\mathbb{Z}$ and $\omega \in \mathcal{C}_p$, where T_y is the translation operator defined by $T_y(\tilde{\omega}) = \tilde{\omega}(\cdot + y)$ for $\tilde{\omega} \in \mathcal{C}_p$ and $y \in l\mathbb{Z}$;
- (E2) the set $\{Q_t(\mathcal{C}_p) : t \geq 0\} \subset \mathcal{C}_p$ is uniformly bounded and, for each $t \geq 0$, $Q_t : \mathcal{C}_p \rightarrow \mathcal{C}_p$ is continuous;
- (E3) for each $t > 0$, the map $Q_t : \mathcal{C}_p \rightarrow \mathcal{C}$ is compact with respect to the compact open topology (as a consequence of the regularity estimates of Theorem 6.2);
- (E4) for each $t \geq 0$, Q_t is order-preserving (i.e., monotone);
- (E5) for each $t > 0$, Q_t admits exactly the two periodic fixed points 0 and p in \mathcal{C}_p : indeed, on the one hand, one knows that 0 and p are two fixed points; on the other hand, for each $\omega \in \mathcal{C}_p \setminus \{0, p\}$, one has $Q_{mt}(\omega) \rightarrow p$ locally uniformly in \mathbb{R} as $m \rightarrow +\infty$ by Theorem 6.5 (and even uniformly in \mathbb{R} if ω is periodic, by Corollary 6.18), hence ω can not be a fixed point of Q_t .

It then follows from [114, Theorem 5.1] that the time-1 map $Q_1 : \mathcal{C}_p \rightarrow \mathcal{C}_p$ admits rightward and leftward asymptotic spreading speeds c_+^* and c_-^* , in the sense that, 1) if $\omega \in \mathcal{C}_p$ is compactly supported, then

$$\begin{cases} \|Q_n(\omega)\|_{L^\infty([nc, +\infty))} \xrightarrow{n \rightarrow +\infty} 0 & \text{for each } c > c_+^*, \\ \|Q_n(\omega)\|_{L^\infty((-\infty, -nc'])} \xrightarrow{n \rightarrow +\infty} 0 & \text{for each } c' > c_-^*, \end{cases} \quad (6.72)$$

and, 2) if $c_+^* + c_-^* > 0$, then, for any $\delta > 0$, there is $r_\delta > 0$ such that

$$\|Q_n(\omega) - p\|_{L^\infty([-nc', nc])} \xrightarrow{n \rightarrow +\infty} 0 \text{ for each } c < c_+^* \text{ and } c' < c_-^* \text{ with } c + c' \geq 0, \quad (6.73)$$

and for each $\omega \in \mathcal{C}_p$ with $\omega \geq \delta$ on an interval of length $2r_\delta$. In the following, our goal is to give computational formulas for c_\pm^* via the linear operators approach of [155, 113], from which we eventually deduce that $c_+^* = c_-^*$.

Thus, in order to compute c_\pm^* , we consider the linearized problem of (6.12)–(6.13) at its zero solution:

$$\begin{cases} U_t = d(x)U_{xx} + f_s(x, 0)U, & t > 0, x \in \mathbb{R} \setminus S, \\ U(t, x^-) = U(t, x^+), U_x(t, x^-) = \sigma U_x(t, x^+), & t > 0, x = nl, \\ U(t, x^-) = U(t, x^+), \sigma U_x(t, x^-) = U_x(t, x^+), & t > 0, x = nl + l_2, \\ U(0, \cdot) = \omega \geq 0, \omega \in \mathcal{C}. \end{cases} \quad (6.74)$$

6.6. Spreading speeds and periodic traveling waves: proofs of Theorems 6.6 and 6.8

Let $\{\mathbb{L}_t\}_{t \geq 0}$ be the linear solution maps generated by (6.74), namely, $\mathbb{L}_t(\omega) = U(t, \cdot; \omega)$ where the function $(t, x) \mapsto U(t, x; \omega)$ is the solution of (6.74) given by the same truncation and limit process as in the proof of Theorem 6.2 (this solution satisfies the same properties as the solution of the nonlinear problem (6.12)–(6.13) given in Theorem 6.2, with the exception of the global boundedness: the solutions of (6.74) are now bounded only locally with respect to $t \in [0, +\infty)$ in general). For any given $\mu \in \mathbb{R}$, substituting $U(t, x; \omega) = e^{-\mu x} v(t, x)$ in (6.74) yields

$$\begin{cases} v_t = d(x)v_{xx} - 2d(x)\mu v_x + (d(x)\mu^2 + f_s(x, 0))v, & t > 0, x \in \mathbb{R} \setminus S, \\ v(t, x^-) = v(t, x^+), [-\mu v + v_x](t, x^-) = \sigma[-\mu v + v_x](t, x^+), & t > 0, x = nl, \\ v(t, x^-) = v(t, x^+), \sigma[-\mu v + v_x](t, x^-) = [-\mu v + v_x](t, x^+), & t > 0, x = nl + l_2, \\ v(0, x) = \omega(x)e^{\mu x}, & x \in \mathbb{R}. \end{cases} \quad (6.75)$$

Let $\{L_{\mu, t}\}_{t \geq 0}$ be the linear solution maps generated by (6.75) and obtained from the substitution $v(t, x) = e^{\mu x} U(t, x; \omega)$, that is, for any $\omega \in \mathcal{C}$ with $\omega \geq 0$ in \mathbb{R} ,

$$\mathbb{L}_t(y \mapsto e^{-\mu y} \omega(y))(x) = e^{-\mu x} L_{\mu, t}(\omega)(x), \text{ for } t \geq 0 \text{ and } x \in \mathbb{R}. \quad (6.76)$$

Substituting $v(t, x) = e^{-\lambda t} \psi(x)$ into (6.75), with ψ periodic and positive, leads to the following periodic eigenvalue problem:

$$\begin{cases} \mathcal{L}_\mu \psi(x) := -d(x)\psi''(x) + 2d(x)\mu\psi'(x) - (d(x)\mu^2 + f_s(x, 0))\psi(x) = \lambda\psi(x), & x \in \mathbb{R} \setminus S, \\ \psi(x^-) = \psi(x^+), [-\mu\psi + \psi'](x^-) = \sigma[-\mu\psi + \psi'](x^+), & x = nl, \\ \psi(x^-) = \psi(x^+), \sigma[-\mu\psi + \psi'](x^-) = [-\mu\psi + \psi'](x^+), & x = nl + l_2, \\ \psi \text{ is periodic in } \mathbb{R}, \psi > 0, \|\psi\|_{L^\infty(\mathbb{R})} = 1. \end{cases} \quad (6.77)$$

Lemma 6.20. *For each $\mu \in \mathbb{R}$, the eigenvalue problem (6.77) has a simple principal eigenvalue $\lambda = \lambda(\mu)$ corresponding to a unique positive continuous periodic principal eigenfunction ψ , which is such that $\psi|_{\bar{I}} \in C^\infty(\bar{I})$ for each patch I in \mathbb{R} . Moreover, there is a max-inf characterization of $\lambda(\mu)$:*

$$\lambda(\mu) = \max_{\psi \in E_\mu} \inf_{x \in \mathbb{R} \setminus S} \frac{\mathcal{L}_\mu \psi(x)}{\psi(x)}, \quad (6.78)$$

where

$$E_\mu = \left\{ \psi \in \mathbb{P} : \psi|_{\bar{I}} \in C^2(\bar{I}) \text{ for each patch } I \subset \mathbb{R}, \psi > 0 \text{ in } \mathbb{R}, \right. \\ \left. \psi \text{ satisfies the interface conditions in (6.77)} \right\}$$

6. Propagation phenomena in periodic patchy landscapes with interface conditions

(we recall that \mathbb{P} is the set of all continuous and periodic functions from \mathbb{R} to \mathbb{R}).⁶ Lastly, the function $\mu \mapsto \lambda(\mu)$ is concave in \mathbb{R} , and $\lambda(0) = \lambda_1$, where $\lambda_1 < 0$ is the principal eigenvalue of the problem (6.16).

Proof. We first fix $\mu \in \mathbb{R}$. The existence of a unique principal eigenvalue for problem (6.77) can be shown similarly as for (6.52). This time, we introduce the space H of periodic functions belonging to $H_{loc}^1(\mathbb{R})$, with $\|u\|_H^2 = \|u\|_{H^1(-l_1,0)}^2 + (1/k)\|u\|_{H^1(0,l_2)}^2$, and G the set of continuous periodic functions u such that $u|_{[-l_1,0]}$ and $u|_{[0,l_2]}$ are of class $C^1([-l_1,0])$ and $C^1([0,l_2])$ respectively, with $\|u\|_G = \|u|_{[-l_1,0]}\|_{C^1([-l_1,0])} + \|u|_{[0,l_2]}\|_{C^1([0,l_2])}$. We also set $\Lambda := \max(f_1'(0) + d_1\mu^2, f_2'(0) + d_2\mu^2) + 1$. For $g \in G$, we consider the following problem

$$\begin{cases} -d(x)u'' + 2d(x)\mu u' + (\Lambda - d(x)\mu^2 - f_s(x,0))u = g, & \text{in } \mathbb{R} \setminus S, \\ u(x^-) = u(x^+), [-\mu u + u'](x^-) = \sigma[-\mu u + u'](x^+), & x = nl, \\ u(x^-) = u(x^+), \sigma[-\mu u + u'](x^-) = [-\mu u + u'](x^+), & x = nl + l_2, \\ u \text{ is periodic.} \end{cases} \quad (6.79)$$

We can solve this problem first in a weak sense, that is, we look for $u \in H$ such that $B(u, z) = \langle g, z \rangle$ for all $z \in H$, where the bilinear form B is defined by

$$\begin{aligned} B(u, z) &= \int_{-l_1}^0 d_1 u' z' + d_1 \mu u' z - d_1 \mu u z' + (\Lambda - d_1 \mu^2 - f_1'(0)) u z \\ &\quad + \frac{1}{k} \int_0^{l_2} d_2 u' z' + d_2 \mu u' z - d_2 \mu u z' + (\Lambda - d_2 \mu^2 - f_2'(0)) u z, \end{aligned}$$

and the scalar product $\langle \cdot, \cdot \rangle$ is defined by

$$\langle g, z \rangle = \int_{-l_1}^0 g z + \frac{1}{k} \int_0^{l_2} g z .$$

Clearly, the map $z \mapsto \langle g, z \rangle$ is continuous in H , and B is continuous in $H \times H$. Moreover, it is easily seen that, for any $u \in H$, $B(u, u) \geq \min(d_1, d_2, 1)\|u\|_H^2$, whence B is coercive. The Lax-Milgram theorem implies the existence of a unique $u \in H$ (hence, u can be identified with its unique continuous representative in \mathbb{R}) satisfying $B(u, z) = \langle g, z \rangle$ for all $z \in H$, and $\|u\|_H \leq C_1 \|g\|_{L^2(-l_1, l_2)}$ for a positive constant C_1 only depending on $d_{1,2}$ and k . As for (6.52), one gets that $u|_{[-l_1,0]}$ and $u|_{[0,l_2]}$ are in $H^2([-l_1,0])$ and $H^2([0,l_2])$ and then in $C^3([-l_1,0])$ and $C^3([0,l_2])$ respectively, that $\|u|_{[-l_1,0]}\|_{C^3([-l_1,0])} + \|u|_{[0,l_2]}\|_{C^3([0,l_2])} \leq C_2 \|g\|_G$ with a positive constant C_2 depending only on $d_{1,2}$, k , $l_{1,2}$, $f_{1,2}'(0)$ and μ , and that the equations in (6.79)

⁶In (6.78), even if the test functions ψ are positive, continuous in \mathbb{R} , and have restrictions to \bar{I} of class $C^2(\bar{I})$ for each patch $I \subset \mathbb{R}$, the infimum of $\mathcal{L}_\mu \psi(x)/\psi(x)$ is taken over the open set $\mathbb{R} \setminus S$ and therefore is not a minimum in general. Notice that the quantity $\mathcal{L}_\mu \psi(x)/\psi(x)$ is in general not defined when $x \in S$, even if the limits at x^\pm exist (but are different in general).

6.6. Spreading speeds and periodic traveling waves: proofs of Theorems 6.6 and 6.8

are satisfied pointwise. Therefore, the linear mapping $T : g \in G \mapsto Tg := u \in G$ is compact. Let now \mathcal{K} be the cone $\mathcal{K} = \{u \in G : u \geq 0 \text{ in } \mathbb{R}\}$. Its interior $\overset{\circ}{\mathcal{K}}$ is not empty, and $\mathcal{K} \cap (-\mathcal{K}) = \{0\}$. We claim that, if $g \in \mathcal{K} \setminus \{0\}$, then $u \in \overset{\circ}{\mathcal{K}}$. Indeed, by using the equality $B(u, z) = \langle g, z \rangle$ with $z := u^- = \max(-u, 0) \in H$, one has

$$-\int_{-l_1}^0 (d_1((u^-)')^2 + (\Lambda - d_1\mu^2 - f_1'(0))(u^-)^2) - \int_0^{l_2} (d_2((u^-)')^2 + (\Lambda - d_2\mu^2 - f_2'(0))(u^-)^2) = \langle g, u^- \rangle \geq 0,$$

hence $u^- \equiv 0$, that is, $u \geq 0$ in \mathbb{R} . From the strong elliptic maximum principle and the Hopf lemma, together with the fact that $g \geq \not\equiv 0$, one concludes that $u > 0$ in $[-l_1, l_2]$ and then in \mathbb{R} by periodicity. Therefore, $T(\mathcal{K} \setminus \{0\}) \subset \overset{\circ}{\mathcal{K}}$. As for (6.52), one then infers from the Krein-Rutman theory the existence and uniqueness of a principal eigenpair (λ, ψ) solving (6.77). We then call $\lambda(\mu)$ this principal eigenvalue λ . Notice that, for each patch $I \subset \mathbb{R}$, the function $\psi|_{\bar{I}}$ is then of class $C^\infty(\bar{I})$ since d and $f_s(\cdot, 0)$ are constant in I .

Let us now prove the max-inf representation (6.78) of $\lambda(\mu)$. Since $\psi \in E_\mu$, one has

$$\lambda(\mu) \leq \sup_{\psi \in E_\mu} \inf_{x \in \mathbb{R} \setminus S} \frac{\mathcal{L}_\mu \psi(x)}{\psi(x)}.$$

To show the reverse inequality, assume by way of contradiction that there is $\varphi \in E_\mu$ such that

$$\lambda(\mu) < \inf_{x \in \mathbb{R} \setminus S} \frac{\mathcal{L}_\mu \varphi(x)}{\varphi(x)}.$$

Then there exists $\eta > 0$ such that

$$-d(x)\varphi''(x) + 2d(x)\mu\varphi'(x) - (d(x)\mu^2 + f_s(x, 0))\varphi(x) - \lambda(\mu)\varphi(x) \geq \eta\varphi(x) > 0 \text{ for all } x \in \mathbb{R} \setminus S.$$

Since $\psi, \varphi \in E_\mu$, there exists $\vartheta > 0$ such that $\varphi \geq \vartheta\psi$ in \mathbb{R} with equality somewhere. Set $w := \varphi - \vartheta\psi$. Then $w \in \mathbb{P}$, $w \geq 0$ in \mathbb{R} , $w|_{\bar{I}} \in C^2(\bar{I})$ for each patch $I \subset \mathbb{R}$, and w satisfies

$$\begin{cases} -d(x)w''(x) + 2d(x)\mu w'(x) - (d(x)\mu^2 + f_s(x, 0))w(x) - \lambda(\mu)w(x) > 0, & x \in \mathbb{R} \setminus S, \\ w(x^-) = w(x^+), \quad [-\mu w + w'](x^-) = \sigma[-\mu w + w'](x^+), & x = nl, \\ w(x^-) = w(x^+), \quad \sigma[-\mu w + w'](x^-) = [-\mu w + w'](x^+), & x = nl + l_2, \\ w \text{ is periodic,} \end{cases} \tag{6.80}$$

and there exists $x_0 \in \mathbb{R}$ such that $w(x_0) = 0$. The point x_0 can not belong to $\mathbb{R} \setminus S$ because of the strict inequality in the first line of (6.80). Therefore, $w > 0$ in $\mathbb{R} \setminus S$ and $x_0 \in S$. The Hopf lemma then implies that $w'(x_0^+) > 0$ and $w'(x_0^-) < 0$, with $w(x_0) = 0$, contradicting

6. Propagation phenomena in periodic patchy landscapes with interface conditions

the interface conditions in (6.80). One has then reached a contradiction. Hence,

$$\lambda(\mu) \geq \sup_{\psi \in E_\mu} \inf_{x \in \mathbb{R} \setminus S} \frac{\mathcal{L}_\mu \psi(x)}{\psi(x)}.$$

The max-inf characterization (6.78) of $\lambda(\mu)$ follows, and the supremum is a maximum since $\psi \in E_\mu$.

Next, we prove the concavity of the function $\mu \mapsto \lambda(\mu)$. With the change of functions $\psi(x) = e^{\mu x} \tilde{\psi}(x)$ in (6.78), one has

$$\frac{\mathcal{L}_\mu \psi(x)}{\psi(x)} = \frac{-d(x) \tilde{\psi}''(x)}{\tilde{\psi}(x)} - f_s(x, 0) \quad \text{for all } x \in \mathbb{R} \setminus S,$$

hence

$$\lambda(\mu) = \max_{\tilde{\psi} \in \tilde{E}_\mu} \inf_{x \in \mathbb{R} \setminus S} \left(\frac{-d(x) \tilde{\psi}''(x)}{\tilde{\psi}(x)} - f_s(x, 0) \right), \quad (6.81)$$

where

$$\begin{aligned} \tilde{E}_\mu = \{ & \tilde{\psi} \in \mathcal{C} : x \mapsto e^{\mu x} \tilde{\psi}(x) \in \mathbb{P}, \tilde{\psi}|_{\bar{I}} \in C^2(\bar{I}) \text{ for each patch } I \subset \mathbb{R}, \tilde{\psi} > 0 \text{ in } \mathbb{R}, \\ & \tilde{\psi} \text{ satisfies the interface conditions in (6.16)} \}. \end{aligned}$$

Consider any real numbers μ_1 and μ_2 , and any $t \in [0, 1]$, and set $\mu = t\mu_1 + (1-t)\mu_2$. One has to verify that $\lambda(\mu) \geq t\lambda(\mu_1) + (1-t)\lambda(\mu_2)$. Let $\tilde{\psi}_1$ and $\tilde{\psi}_2$ be arbitrarily chosen in \tilde{E}_{μ_1} and \tilde{E}_{μ_2} , respectively. Define $z_1 = \ln \tilde{\psi}_1$, $z_2 = \ln \tilde{\psi}_2$, $z = tz_1 + (1-t)z_2$ and $\tilde{\psi} = e^z$. We claim that $\tilde{\psi} \in \tilde{E}_\mu$. In fact, since $\tilde{\psi} = \tilde{\psi}_1^t \tilde{\psi}_2^{1-t}$, then $\tilde{\psi} \in \mathcal{C}$ and $\tilde{\psi}|_{\bar{I}} \in C^2(\bar{I})$ for each patch $I \subset \mathbb{R}$. Furthermore, the function $x \mapsto e^{\mu x} \tilde{\psi}(x) = (e^{\mu_1 x} \tilde{\psi}_1(x))^t \times (e^{\mu_2 x} \tilde{\psi}_2(x))^{1-t}$ is periodic, and the flux conditions in (6.16) can be easily derived from $\tilde{\psi}' = (\tilde{\psi}_1^t \tilde{\psi}_2^{1-t})' = t\tilde{\psi}_1^{t-1} \tilde{\psi}_1' \tilde{\psi}_2^{1-t} + (1-t)\tilde{\psi}_2^{-t} \tilde{\psi}_2' \tilde{\psi}_1^t$ in $\mathbb{R} \setminus S$ and from the fact that both $\tilde{\psi}_1 \in \tilde{E}_{\mu_1}$ and $\tilde{\psi}_2 \in \tilde{E}_{\mu_2}$ satisfy the interface conditions in (6.16). Therefore, by (6.81) we have

$$\lambda(\mu) \geq \inf_{x \in \mathbb{R} \setminus S} \left(\frac{-d(x) \tilde{\psi}''(x)}{\tilde{\psi}(x)} - f_s(x, 0) \right).$$

Notice that, for each $x \in \mathbb{R} \setminus S$, one has $-d(x) \tilde{\psi}''(x) / \tilde{\psi}(x) = -d(x) z''(x) - d(x) (z'(x))^2$, and

$$\begin{aligned} (z'(x))^2 &= (tz_1'(x) + (1-t)z_2'(x))^2 = t(z_1'(x))^2 + (1-t)(z_2'(x))^2 - t(1-t)(z_1'(x) - z_2'(x))^2 \\ &\leq t(z_1'(x))^2 + (1-t)(z_2'(x))^2, \end{aligned}$$

hence

$$\begin{aligned} \frac{-d(x)\tilde{\psi}''(x)}{\tilde{\psi}(x)} - f_s(x, 0) &\geq t \left(-d(x)z_1''(x) - d(x)(z_1'(x))^2 - f_s(x, 0) \right) \\ &\quad + (1-t) \left(-d(x)z_2''(x) - d(x)(z_2'(x))^2 - f_s(x, 0) \right). \end{aligned}$$

Eventually, we find that

$$\begin{aligned} \lambda(\mu) &\geq \inf_{x \in \mathbb{R} \setminus S} \left(\frac{-d(x)\tilde{\psi}''(x)}{\tilde{\psi}(x)} - f_s(x, 0) \right) \\ &\geq t \inf_{x \in \mathbb{R} \setminus S} \left(\frac{-d(x)\tilde{\psi}_1''(x)}{\tilde{\psi}_1(x)} - f_s(x, 0) \right) + (1-t) \inf_{x \in \mathbb{R} \setminus S} \left(\frac{-d(x)\tilde{\psi}_2''(x)}{\tilde{\psi}_2(x)} - f_s(x, 0) \right). \end{aligned}$$

Since $\tilde{\psi}_1$ and $\tilde{\psi}_2$ were arbitrarily chosen in \tilde{E}_{μ_1} and \tilde{E}_{μ_2} respectively, one infers from (6.81) that $\lambda(\mu) \geq t\lambda(\mu_1) + (1-t)\lambda(\mu_2)$. That is, $\mu \mapsto \lambda(\mu)$ is concave in \mathbb{R} , which also yields the continuity of this function. Lastly, we also observe that the problem (6.77) coincides with (6.16) when $\mu = 0$, that is, $\lambda(0) = \lambda_1$, which is here negative by assumption. This completes the proof of Lemma 6.20. \square

Since for each $t > 0$ the linear operator $L_{\mu,t}$ defined by (6.75)–(6.76) is strongly positive and compact, the Krein-Rutman theorem again implies that its spectral radius $r(L_{\mu,t})$ is positive and is the principal eigenvalue of $L_{\mu,t}$, that is, $r(L_{\mu,t}) = e^{-\lambda(\mu)t}$.

We are now in a position to give variational formulas for the rightward and leftward asymptotic spreading speeds c_{\pm}^* given by (6.72)–(6.73) via the linear operators approach.

Theorem 6.21. *Let c_+^* and c_-^* be the rightward and leftward asymptotic spreading speeds of Q_1 , given by (6.72)–(6.73). Then,*

$$c_+^* = \inf_{\mu > 0} \frac{-\lambda(\mu)}{\mu}, \quad c_-^* = \inf_{\mu > 0} \frac{-\lambda(-\mu)}{\mu}. \quad (6.82)$$

Furthermore, we have $c_+^* = c_-^* > 0$.

Proof. Due to assumption (6.15), and we have $f(x, s) \leq f_s(x, 0)s$ for all $x \in \mathbb{R} \setminus S$ and $s \geq 0$. Then, for every $\omega \in \mathcal{C}_p$ and $n \in \mathbb{N}$, the solution $u^n := u^n(\cdot, \cdot; \omega)$ of (6.21)–(6.24) satisfies

$$\begin{cases} u_t^n \leq d(x)u_{xx}^n + f_s(x, 0)u^n, & t > 0, x \in (-nl, nl) \setminus S, \\ u^n(t, x^-) = u^n(t, x^+), \quad u_x^n(t, x^-) = \sigma u_x^n(t, x^+), & t > 0, x \in S_1 \cap (-nl, nl), \\ u^n(t, x^-) = u^n(t, x^+), \quad \sigma u_x^n(t, x^-) = u_x^n(t, x^+), & t > 0, x \in S_2 \cap (-nl, nl). \end{cases}$$

Proposition 6.23 and the construction of the solutions $U(\cdot, \cdot; \omega)$ of (6.74) by using the same truncation and limit process as in the proof of Theorem 6.2 imply that $u^n(t, x; \omega) \leq U^n(t, x; \omega)$

6. Propagation phenomena in periodic patchy landscapes with interface conditions

for all $(t, x) \in [0, +\infty) \times [-nl, nl]$ and $n \in \mathbb{N}$, hence $u(t, x; \omega) \leq U(t, x, \omega)$ for all $(t, x) \in [0, +\infty) \times \mathbb{R}$. In other words, $Q_t(\omega) \leq \mathbb{L}_t(\omega)$ in \mathbb{R} for all $t \geq 0$ and $\omega \in \mathcal{C}_p$. Particularly, by taking $t = 1$, one has $Q_1(\omega) \leq \mathbb{L}_1(\omega)$ in \mathbb{R} for all $\omega \in \mathcal{C}_p$. For any $\mu \in \mathbb{R}$, one has

$$\mathbb{L}^\mu(\psi)(x) := e^{\mu x} \mathbb{L}_1(y \mapsto e^{-\mu y} \psi(y))(x) = L_{\mu,1}(\psi)(x) \quad \text{for every } \psi \in \mathbb{P} \text{ and } x \in \mathbb{R},$$

thanks to (6.76). It then follows that $e^{-\lambda(\mu)}$ is the principal eigenvalue of \mathbb{L}^μ . On the other hand, by Lemma 6.20, the function $\mu \mapsto \ln(e^{-\lambda(\mu)}) = -\lambda(\mu)$ is convex. With similar arguments as in [155, Theorem 2.5] and in [113, Theorem 3.10 (i)], one then obtains that

$$c_+^* \leq \inf_{\mu > 0} \frac{\ln(e^{-\lambda(\mu)})}{\mu} = \inf_{\mu > 0} \frac{-\lambda(\mu)}{\mu}. \quad (6.83)$$

On the other hand, for any given $\varepsilon > 0$, there is a $\delta > 0$ such that

$$f(x, s) \geq (f_s(x, 0) - \varepsilon)s, \quad \text{for all } x \in \mathbb{R} \setminus S \text{ and } u \in [0, \delta].$$

From the continuity of the solutions of (6.12)–(6.13) with respect to the initial conditions, as stated in Theorem 6.2, there is a positive real number η such that $\eta \leq p$ in \mathbb{R} and $u(t, x; \eta) \leq \delta$ for all $t \in [0, 1]$ and $x \in \mathbb{R}$. Define

$$\mathcal{C}_\eta = \{\omega \in \mathcal{C} : 0 \leq \omega \leq \eta \text{ in } \mathbb{R}\}.$$

It then follows from Theorem 6.2 that

$$0 \leq u(t, x; \omega) \leq u(t, x; \eta) \leq \delta, \quad \text{for all } \omega \in \mathcal{C}_\eta, t \in [0, 1] \text{ and } x \in \mathbb{R}.$$

Thus, for any $\omega \in \mathcal{C}_\eta$, the solution $u(\cdot, \cdot; \omega)$ to (6.12)–(6.13) satisfies

$$\begin{cases} u_t \geq d(x)u_{xx} + (f_s(x, 0) - \varepsilon)u, & t \in (0, 1], x \in \mathbb{R} \setminus S, \\ u(t, x^-) = u(t, x^+), u_x(t, x^-) = \sigma u_x(t, x^+), & t \in (0, 1], x = nl, \\ u(t, x^-) = u(t, x^+), \sigma u_x(t, x^-) = u_x(t, x^+), & t \in (0, 1], x = nl + l_2. \end{cases}$$

Consider now the linear problem

$$\begin{cases} V_t = d(x)V_{xx} + (f_s(x, 0) - \varepsilon)V, & t > 0, x \in \mathbb{R} \setminus S, \\ V(t, x^-) = V(t, x^+), V_x(t, x^-) = \sigma V_x(t, x^+), & t > 0, x = nl, \\ V(t, x^-) = V(t, x^+), \sigma V_x(t, x^-) = V_x(t, x^+), & t > 0, x = nl + l_2. \end{cases} \quad (6.84)$$

Let $\{\mathbb{L}_t^\varepsilon\}_{t \geq 0}$ be the solution maps generated by the above linear system, as for (6.74) above ($\mathbb{L}_t^0 = \mathbb{L}_t$ for all $t \geq 0$). Then, Proposition 6.23 and the construction of the solutions of (6.84)

6.6. Spreading speeds and periodic traveling waves: proofs of Theorems 6.6 and 6.8

as in the proof of Theorem 6.2 imply that $\mathbb{L}_t^\varepsilon(\omega) \leq Q_t(\omega)$ in \mathbb{R} for all $t \in [0, 1]$ and $\omega \in \mathcal{C}_\eta$. In particular, $\mathbb{L}_1^\varepsilon(\omega) \leq Q_1(\omega)$ in \mathbb{R} for all $\omega \in \mathcal{C}_\eta$.

Denote by $\lambda^\varepsilon(\mu)$ the first eigenvalue of the following eigenvalue problem:

$$\begin{cases} -d(x)\psi''(x) + 2\mu d(x)\psi'(x) - (d(x)\mu^2 + (f_s(x, 0) - \varepsilon))\psi(x) = \lambda^\varepsilon(\mu) \psi(x), & x \in \mathbb{R} \setminus S, \\ \psi(x^-) = \psi(x^+), \quad [-\mu\psi + \psi'](x^-) = \sigma[-\mu\psi + \psi'](x^+), & x = nl, \\ \psi(x^-) = \psi(x^+), \quad \sigma[-\mu\psi + \psi'](x^-) = [-\mu\psi + \psi'](x^+), & x = nl + l_2, \\ \psi \text{ is periodic in } \mathbb{R}, \quad \psi > 0, \quad \|\psi\|_{L^\infty(\mathbb{R})} = 1. \end{cases}$$

By uniqueness of the principal eigenvalue of (6.77), there holds $\lambda^\varepsilon(\mu) = \lambda(\mu) + \varepsilon$. From the convexity of the function $\mu \mapsto -\lambda^\varepsilon(\mu) = -\lambda(\mu) - \varepsilon$ and the arguments in [155, Theorem 2.4] and in [113, Theorem 3.10 (ii)], one infers that

$$c_+^* \geq \inf_{\mu > 0} \frac{\ln(e^{-\lambda^\varepsilon(\mu)})}{\mu} = \inf_{\mu > 0} \frac{-\lambda(\mu) - \varepsilon}{\mu}, \quad (6.85)$$

and this property is valid for all $\varepsilon > 0$. Together with (6.83), (6.85), and the positivity of $-\lambda(0) = -\lambda_1$, it follows that

$$c_+^* = \inf_{\mu > 0} \frac{-\lambda(\mu)}{\mu}.$$

By the change of variable $v(t, x; \omega) = u(t, -l_1 - x; \omega(-l_1 - \cdot))$,⁷ one gets that c_-^* is the rightward asymptotic spreading speed of the resulting problem for the solutions $v(\cdot, \cdot; \omega)$. Therefore,

$$c_-^* = \inf_{\mu > 0} \frac{-\lambda(-\mu)}{\mu}.$$

Consequently, (6.82) is proved.

Next, for any $\mu \in \mathbb{R}$, if ψ_μ is the principal eigenfunction of the problem (6.77), with principal eigenvalue $\lambda(\mu)$, then the function $x \mapsto \widehat{\psi}(x) := \psi_\mu(-l_1 - x)$ satisfies (6.77) with $-\mu$ instead of μ in the equations and the interface conditions, but with the same eigenvalue $\lambda(\mu)$. By uniqueness of the principal eigenvalue, one deduces that $\lambda(-\mu) = \lambda(\mu)$. Therefore, (6.82) yields $c_+^* = c_-^*$.

Lastly, consider any compactly supported $\omega \in \mathcal{C}_p$ such that $\omega \not\equiv 0$ in \mathbb{R} and $\omega(x) < p(x)$ for all $x \in \mathbb{R}$ (and remember that ω and p are continuous, and that p is periodic and positive in \mathbb{R}). From Theorem 6.5 (i), one knows that $u(t, \cdot; \omega) \rightarrow p$ as $t \rightarrow +\infty$ locally uniformly in \mathbb{R} . Hence, there is $T \in \mathbb{N}$ such that $u(T, \cdot; \omega) \geq \omega(\cdot \pm l)$ in \mathbb{R} . Theorem 6.2 and Proposition 6.19 then imply in particular that $u(2T, \cdot; \omega) \geq \omega(\cdot \pm 2l)$ in \mathbb{R} , hence $u(mT, \cdot; \omega) \geq \omega(\cdot \pm ml)$ in

⁷Notice that $p(x) = p(-l_1 - x)$ for all $x \in \mathbb{R}$ by invariance of (6.17) with respect to this change of variable and by the uniqueness result of Theorem 6.4, hence $x \mapsto \omega(-l_1 - x) \in \mathcal{C}_p$ for every $\omega \in \mathcal{C}_p$.

6. Propagation phenomena in periodic patchy landscapes with interface conditions

\mathbb{R} for all $m \in \mathbb{N}$ by an immediate induction. In other words, $Q_{mT}(\omega) \geq \omega(\cdot \pm ml)$ in \mathbb{R} for all $m \in \mathbb{N}$, and it follows from property (6.72) that $c_{\pm}^* > 0$. This completes the proof of Theorem 6.21. \square

Proofs of Theorems 6.6 and 6.8. By [114, Theorems 5.2 and 5.3], together with Theorems 6.5 (i) and 6.21, one directly obtains Theorem 6.6, with spreading speed $c^* := c_{\pm}^*$, as well as the existence of time-nondecreasing periodic rightward and leftward traveling waves for problem (6.12)–(6.13) with all and only all speeds $c \geq c^*$. To complete the proof of Theorem 6.8, it is left to show that these periodic traveling waves are strictly monotone in time. For $c \geq c^* > 0$, consider a periodic rightward (the case of leftward waves can be handled similarly) traveling wave solving (6.12)–(6.13), written as $u(t, x) = W(x - ct, x)$ (with $u(t, x) = Q_{t-t'}(u(t', \cdot))(x)$ for all $t' \leq t \in \mathbb{R}$ and $x \in \mathbb{R}$), where $W(s, x)$ is periodic in x , nonincreasing in s , and $W(-\infty, x) = p(x)$, $W(+\infty, x) = 0$ for all $x \in \mathbb{R}$. Notice in particular that $0 \leq u(t, x) \leq p(x)$ for all $(t, x) \in \mathbb{R} \times \mathbb{R}$, that $u(t, x) \rightarrow 0$ as $t \rightarrow -\infty$ and $u(t, x) \rightarrow p(x)$ as $t \rightarrow +\infty$ for every $x \in \mathbb{R}$, and that $u(t+h, x) \geq u(t, x)$ for every $h > 0$ and $(t, x) \in \mathbb{R}^2$. From the Schauder estimates of Theorem 6.2 and Proposition 6.25, it follows that, for every $h > 0$ and $t_0 \in \mathbb{R}$, either $u(\cdot + h, \cdot) \equiv u$ in $(t_0, +\infty) \times \mathbb{R}$, or $u(\cdot + h, \cdot) > u$ in $(t_0, +\infty) \times \mathbb{R}$. Since $u(-\infty, x) = 0 < p(x) = u(+\infty, x)$ for every $x \in \mathbb{R}$, one easily infers that, for every $h > 0$, $u(\cdot + h, \cdot) > u$ in $\mathbb{R} \times \mathbb{R}$. Therefore, u is increasing in t and the periodic rightward traveling wave $W(x - ct, x)$ is decreasing in its first argument, and all properties of Definition 6.7 are therefore satisfied. \square

6.7 Comparison principles

In this appendix, we prove comparison results for the problem (6.12)–(6.13), as well as for the patchy model in an interval $(a, b) \subset \mathbb{R}$ composed of finitely many patches, say I_i for $i = 1, \dots, n$. For the latter, which we first deal with, the landscape (a, b) can be either bounded or unbounded. Set $-\infty \leq a = x_0 < x_1 < \dots < x_n = b \leq +\infty$ and $I_i = (x_{i-1}, x_i)$ for $i = 1, \dots, n$. Since the results will be used in the present chapter and in the future work [95], we state them in more generality to cover different applications. We consider a one-dimensional parabolic operator

$$\mathcal{L}u := u_t - d(x)u_{xx} - c(t, x)u_x - F(x, u), \text{ for } t > 0 \text{ and } x \in (a, b) \setminus \{x_1, \dots, x_{n-1}\} = \bigcup_{i=1}^n I_i,$$

with interface conditions

$$u(t, x_i^-) = u(t, x_i^+) \text{ and } u_x(t, x_i^-) = \sigma_i u_x(t, x_i^+), \text{ for } t > 0 \text{ and } i = 1, \dots, n-1. \quad (6.86)$$

If a or b is finite, we impose Dirichlet-type boundary conditions:

$$u(t, a) = \varphi^-(t) \text{ or } u(t, b) = \varphi^+(t), \text{ for } t \geq 0, \quad (6.87)$$

where $\varphi^\pm : [0, +\infty) \rightarrow \mathbb{R}$ are given continuous functions. Here, the function $x \mapsto d(x)$ is assumed to be constant and positive in each patch, i.e., $d|_{I_i} = d_i > 0$ for some constant d_i ,⁸ the function c is assumed to be continuous and bounded in $(0, T_0) \times \cup_{i=1}^n I_i$ for every $T_0 \in (0, +\infty)$, the σ_i 's are given positive real numbers, and, for each $1 \leq i \leq n$, $F(x, s) = f_i(s)$ for $(x, s) \in I_i \times \mathbb{R}$, with $f_i \in C^1(\mathbb{R})$.

We first give the definition of super- and subsolutions of $\mathcal{L}u = 0$ associated with the interface and boundary conditions (6.86)–(6.87).

Definition 6.22. For $T \in (0, +\infty]$, we say that a continuous function $\bar{u} : [0, T) \times \overline{(a, b)} \rightarrow \mathbb{R}$,⁹ which is assumed to be bounded in $[0, T_0] \times \overline{(a, b)}$ for every $T_0 \in (0, T)$, is a supersolution for the problem $\mathcal{L}u = 0$ with interface and boundary conditions (6.86)–(6.87), if $\bar{u}|_{(0, T) \times \bar{I}_i} \in C_{t;x}^{1;2}((0, T) \times \bar{I}_i)$ satisfies $\mathcal{L}\bar{u}|_{(0, T) \times I_i} \geq 0$ in the classical sense for each $1 \leq i \leq n$, and if

$$\bar{u}_x(t, x_i^-) \geq \sigma_i \bar{u}_x(t, x_i^+), \text{ for } t \in (0, T) \text{ and } i = 1, \dots, n-1,$$

and

$$\bar{u}(t, a) \geq \varphi^-(t) \text{ or } \bar{u}(t, b) \geq \varphi^+(t), \text{ for } t \in [0, T),$$

provided that a or b is finite. A subsolution can be defined in a similar way with all the inequality signs above reversed.

The first result of the appendix is a comparison principle between super- and subsolutions when the interval (a, b) is bounded.

Proposition 6.23 (Comparison principle in bounded intervals). Assume that $-\infty < a < b < +\infty$. For $T \in (0, +\infty]$, let \bar{u} and \underline{u} be, respectively, a super- and a subsolution in $[0, T) \times [a, b]$ of $\mathcal{L}u = 0$ with (6.86)–(6.87), and assume that $\bar{u}(0, \cdot) \geq \underline{u}(0, \cdot)$ in $[a, b]$. Then, $\bar{u} \geq \underline{u}$ in $[0, T) \times [a, b]$ and, if $\bar{u}(0, \cdot) \not\equiv \underline{u}(0, \cdot)$, then $\bar{u} > \underline{u}$ in $(0, T) \times (a, b)$.

Proof. Fix any $T_0 \in (0, T)$ and set

$$M := \max \left(\|\bar{u}\|_{L^\infty([0, T_0] \times [a, b])}, \|\underline{u}\|_{L^\infty([0, T_0] \times [a, b])} \right) \text{ and } \mu := \max_{1 \leq i \leq n} \|f_i'\|_{L^\infty([-M, M])} \quad (6.88)$$

(notice that M and μ are nonnegative real numbers owing to the assumptions on \bar{u} , \underline{u} and f_i). Define

$$w(t, x) := (\bar{u}(t, x) - \underline{u}(t, x)) e^{-\mu t} \text{ for } (t, x) \in [0, T_0] \times [a, b].$$

⁸From the proofs below, it is easily seen that we can consider more general diffusion coefficients $d(t, x)$ such that $d|_{(0, +\infty) \times I_i}$ can be extended to a continuous and positive function in $[0, +\infty) \times \bar{I}_i$, for each $1 \leq i \leq n$.

⁹The notation $\overline{(a, b)}$ covers all possible four cases when a or b is finite or not. If a and b are finite, then $\overline{(a, b)} = [a, b]$.

6. Propagation phenomena in periodic patchy landscapes with interface conditions

The function w is continuous in $[0, T_0] \times [a, b]$, with restriction in $(0, T_0] \times \overline{I_i}$ of class $C_{t,x}^{1;2}((0, T_0] \times \overline{I_i})$ for each $1 \leq i \leq n$, and we see from the mean value theorem that w satisfies

$$\mathcal{N}w := w_t - d(x)w_{xx} - c(t, x)w_x + (\mu - F_s(x, \eta(t, x)))w \geq 0, \text{ for } (t, x) \in (0, T_0] \times \bigcup_{i=1}^n I_i, \quad (6.89)$$

where $\eta(t, x)$ is an intermediate value between $\overline{u}(t, x)$ and $\underline{u}(t, x)$ (hence, $|\eta(t, x)| \leq M$ and $\mu - F_s(x, \eta(t, x)) \geq 0$). Moreover, there holds

$$w_x(t, x_i^-) \geq \sigma_i w_x(t, x_i^+), \text{ for } t \in (0, T_0] \text{ and } i = 1, \dots, n-1, \quad (6.90)$$

together with $w(0, x) = \overline{u}(0, x) - \underline{u}(0, x) \geq 0$ for all $x \in [a, b]$, $w(t, a) \geq 0$ and $w(t, b) \geq 0$ for all $t \in [0, T_0]$.

Consider now an arbitrary $\varepsilon > 0$ and let us introduce the auxiliary function z defined by

$$z(t, x) := w(t, x) + \varepsilon(t+1) \text{ for } (t, x) \in [0, T_0] \times [a, b].$$

The function z has at least the same regularity as w , and $z > 0$ in $\{0\} \times [a, b]$ and in $[0, T_0] \times \{a, b\}$. Moreover,

$$\mathcal{N}z = \mathcal{N}w + \varepsilon + (\mu - F_s(x, \eta(t, x)))\varepsilon(t+1) \geq \varepsilon > 0, \text{ for } (t, x) \in (0, T_0] \times \bigcup_{i=1}^n I_i, \quad (6.91)$$

with

$$z_x(t, x_i^-) \geq \sigma_i z_x(t, x_i^+), \text{ for } t \in (0, T_0] \text{ and } i = 1, \dots, n-1. \quad (6.92)$$

We claim that $z(t, x) > 0$ for all $(t, x) \in [0, T_0] \times [a, b]$. Assume not. Then, by continuity, there is a point $(t_0, y_0) \in (0, T_0] \times (a, b)$ such that $z(t_0, y_0) = \min_{[0, t_0] \times [a, b]} z = 0$. We first assume that $y_0 \in I_i$ for some $1 \leq i \leq n$. Since $z_t(t_0, y_0) \leq 0$, $z_x(t_0, y_0) = 0$ and $z_{xx}(t_0, y_0) \geq 0$, we see that

$$\mathcal{N}z(t_0, y_0) = z_t(t_0, y_0) - d_i z_{xx}(t_0, y_0) + c(t_0, y_0)z_x(t_0, y_0) + (\mu - f'_i(\eta(t_0, y_0)))z(t_0, y_0) \leq 0, \quad (6.93)$$

which is impossible by (6.91). Thus, necessarily, we can assume without loss of generality that $y_0 = x_i$ for some $1 \leq i \leq n-1$ and that $z > 0$ in $[0, t_0] \times \bigcup_{i=1}^n I_i$. Then, the Hopf lemma yields

$$z_x(t_0, x_i^-) < 0 \text{ and } z_x(t_0, x_i^+) > 0,$$

which contradicts (6.92). Consequently, $z > 0$ in $[0, T_0] \times [a, b]$. Since $\varepsilon > 0$ was arbitrarily

chosen, we obtain that $w \geq 0$ in $[0, T_0] \times [a, b]$, which immediately implies $\bar{u} \geq \underline{u}$ in $[0, T_0] \times [a, b]$, and then in $[0, T) \times [a, b]$ since $T_0 \in (0, T)$ was arbitrary.

Let us now further assume that $\bar{u}(0, \cdot) \not\equiv \underline{u}(0, \cdot)$ in $[a, b]$, hence by continuity $\bar{u}(0, \cdot) > \underline{u}(0, \cdot)$ in some non-empty open subinterval of (a, b) which has a non-empty intersection with I_i , for some $1 \leq i \leq n$. Since we already know from the previous paragraph that $\bar{u} \geq \underline{u}$ in $[0, T) \times [a, b]$, it follows from the interior strong parabolic maximum principle that $\bar{u} > \underline{u}$ in $(0, T) \times I_i$. If the interval (a, b) reduces to a single patch (that is, $n = 1$), then we are done. Otherwise, either x_{i-1} or x_i belongs to the open interval (a, b) . Let us consider the case when $x_i \in (a, b)$ (hence, $i \leq n - 1$). We now claim that $\bar{u}(t, x_i) > \underline{u}(t, x_i)$ for all $t \in (0, T)$. Indeed, otherwise, there is a time $t_0 \in (0, T)$ such that $\bar{u}(t_0, x_i) = \underline{u}(t_0, x_i)$, and the Hopf lemma then implies that

$$\bar{u}_x(t_0, x_i^-) < \underline{u}_x(t_0, x_i^-).$$

But $\bar{u}_x(t_0, x_i^+) \geq \underline{u}_x(t_0, x_i^+)$ since $\bar{u} \geq \underline{u}$ in $[0, T) \times \overline{I_{i+1}}$ and $\bar{u}(t_0, x_i) = \underline{u}(t_0, x_i)$. One finally gets a contradiction with the assumptions on the spatial derivatives of the super- and subsolutions \bar{u} and \underline{u} at x_i^\pm . Therefore, $\bar{u}(t, x_i) > \underline{u}(t, x_i)$ for all $t \in (0, T)$. By continuity and by applying the strong interior parabolic maximum principle in $(0, T) \times I_{i+1}$, we infer that $\bar{u} > \underline{u}$ in $(0, T) \times I_{i+1}$. By an immediate induction, going from one patch to the adjacent one in the left or right directions, we get that $\bar{u} > \underline{u}$ in $(0, T) \times (a, b)$. The proof of Proposition 6.23 is thereby complete. \square

Then we prove in Proposition 6.24 the comparison principle when $(a, b) = \mathbb{R}$, still in the case of a finite number of interfaces (the case when the domain is of the form $(a, +\infty)$ with $a \in \mathbb{R}$, or $(-\infty, b)$ with $b \in \mathbb{R}$, can be handled by a combination and a slight modification of the proofs of Propositions 6.23 and 6.24).

Proposition 6.24 (Comparison principle in \mathbb{R}). *For $T \in (0, +\infty]$, let \bar{u} and \underline{u} be, respectively, a super- and a subsolution in $[0, T) \times \mathbb{R}$ of $\mathcal{L}u = 0$ with (6.86), and assume that $\bar{u}(0, \cdot) \geq \underline{u}(0, \cdot)$ in \mathbb{R} . Then, $\bar{u} \geq \underline{u}$ in $[0, T) \times \mathbb{R}$ and, if $\bar{u}(0, \cdot) \not\equiv \underline{u}(0, \cdot)$, then $\bar{u} > \underline{u}$ in $(0, T) \times \mathbb{R}$.*

Proof. Fix any $T_0 \in (0, T)$ and define the nonnegative real numbers M and μ as in (6.88) with this time \mathbb{R} instead of $[a, b]$ in the definition of M . Denote $w(t, x) := (\bar{u}(t, x) - \underline{u}(t, x))e^{-\mu t}$ for $(t, x) \in [0, T_0] \times \mathbb{R}$. The function w is continuous and bounded in $[0, T_0] \times \mathbb{R}$, with restriction in $(0, T_0) \times \overline{I_i}$ of class $C_{t,x}^{1;2}((0, T_0) \times \overline{I_i})$ for each $1 \leq i \leq n$ (notice that, here, $I_1 = (-\infty, x_1)$ and $I_n = (x_{n-1}, +\infty)$ are unbounded), and w still satisfies (6.89)–(6.90), together with $w(0, \cdot) = \bar{u}(0, \cdot) - \underline{u}(0, \cdot) \geq 0$ in \mathbb{R} . Set now $R = \max_{1 \leq i \leq n-1} |x_i| + 1 > 0$, and let $\varrho : \mathbb{R} \rightarrow \mathbb{R}$ be a nonnegative C^2 function with bounded first and second order derivatives,

6. Propagation phenomena in periodic patchy landscapes with interface conditions

and satisfying

$$\begin{cases} \varrho = 0 \text{ in } [-R, R], & \lim_{x \rightarrow +\infty} \varrho(x) = +\infty, \\ \left(\max_{1 \leq i \leq n} d_i \right) \times \|\varrho''\|_{L^\infty(\mathbb{R})} + \|c\|_{L^\infty((0, T_0) \times \cup_{i=1}^n I_i)} \times \|\varrho'\|_{L^\infty(\mathbb{R})} \leq \frac{1}{2}. \end{cases}$$

Let us consider an arbitrary $\varepsilon > 0$, and introduce an auxiliary function z defined by

$$z(t, x) := w(t, x) + \varepsilon(\varrho(|x|) + t + 1) \quad \text{for } (t, x) \in [0, T_0] \times \mathbb{R}.$$

The function z has at least the same regularity as w , while $z(0, x) \geq \varepsilon > 0$ for all $x \in \mathbb{R}$ and $z(t, x) \rightarrow +\infty$ as $|x| \rightarrow +\infty$ uniformly in $t \in [0, T_0]$. Moreover,

$$\mathcal{N}z \geq \mathcal{N}w + \varepsilon - \varepsilon d(x) \varrho''(|x|) - \varepsilon |c(t, x) \varrho'(|x|)| + (\mu - F_s(x, \eta(t, x))) \varepsilon (\varrho(|x|) + t + 1) \geq \frac{\varepsilon}{2} > 0$$

for $(t, x) \in (0, T_0] \times \bigcup_{i=1}^n I_i$, and (6.92) still holds from (6.90), the definition of R and the choice of ϱ . We claim that $z(t, x) > 0$ for all $(t, x) \in [0, T_0] \times \mathbb{R}$. Assume not. Then, by continuity and the above properties of z , there is a point $(t_0, y_0) \in (0, T_0] \times \mathbb{R}$ such that $z(t_0, y_0) = \min_{[0, t_0] \times \mathbb{R}} z = 0$. If $y_0 \in I_i$ for some $1 \leq i \leq n$, then we see as in (6.93) that $\mathcal{N}z(t_0, y_0) \leq 0$, which is impossible. Thus, we can assume without loss of generality that $y_0 = x_i$ for some $1 \leq i \leq n-1$ and that $z > 0$ in $[0, t_0] \times \cup_{i=1}^n I_i$. Then, the Hopf lemma yields $z_x(t_0, x_i^-) < 0$ and $z_x(t_0, x_i^+) > 0$, contradicting (6.92). Consequently, $z > 0$ in $[0, T_0] \times \mathbb{R}$. Hence, by passing to the limit as $\varepsilon \rightarrow 0^+$, we infer that $w \geq 0$ in $[0, T_0] \times \mathbb{R}$, that is, $\bar{u} \geq \underline{u}$ in $[0, T_0] \times \mathbb{R}$, and then $\bar{u} \geq \underline{u}$ in $[0, T) \times \mathbb{R}$ owing to the arbitrariness of $T_0 \in (0, T)$.

Lastly, if one further assumes that $\bar{u}(0, \cdot) \not\equiv \underline{u}(0, \cdot)$, then the proof of the strict inequality $\bar{u} > \underline{u}$ in $(0, T) \times \mathbb{R}$ follows similar lines as in the proof of the preceding proposition. \square

The last statement is a comparison principle for the problem (6.12)–(6.13) involving the countably many interfaces $S = l\mathbb{Z} \cup (l\mathbb{Z} + l_2)$. For this problem with a given initial condition, Proposition 6.25 also provides the uniqueness of the solutions satisfying the conditions of the statement.

Proposition 6.25 (Comparison principle for (6.12)–(6.13)). *For $T \in (0, +\infty]$, let \bar{u} and \underline{u} be, respectively, a super- and a subsolution of (6.12)–(6.13) in $[0, T) \times \mathbb{R}$ (with a natural extension of Definition 6.22) with $\bar{u}(0, \cdot) \geq \underline{u}(0, \cdot)$ in \mathbb{R} , and assume that, for every $T_0 \in (0, T)$, there are $\theta \in (0, 1)$ and $C \geq 0$ such that $\bar{u}|_{[0, T_0] \times \bar{I}}$ and $\underline{u}|_{[0, T_0] \times \bar{I}}$ are of class $C_{t;x}^{1,\theta;2,\theta}([0, T_0] \times \bar{I})$ with $\|\bar{u}|_{[0, T_0] \times \bar{I}}\|_{C_{t;x}^{1,\theta;2,\theta}([0, T_0] \times \bar{I})} + \|\underline{u}|_{[0, T_0] \times \bar{I}}\|_{C_{t;x}^{1,\theta;2,\theta}([0, T_0] \times \bar{I})} \leq C$ for every patch $I \subset \mathbb{R}$. Then, $\bar{u} \geq \underline{u}$ in $[0, T) \times \mathbb{R}$, and, if $\bar{u}(0, \cdot) \not\equiv \underline{u}(0, \cdot)$, then $\bar{u} > \underline{u}$ in $(0, T) \times \mathbb{R}$*

Proof. Fix any $T_0 \in (0, T)$ and define the nonnegative real numbers M and μ as in (6.88) with this time \mathbb{R} instead of $[a, b]$ in the definition of M , and the only functions f_1 and f_2

in the definition of μ . Denote $w(t, x) := (\bar{u}(t, x) - \underline{u}(t, x))e^{-\mu t}$ for $(t, x) \in [0, T_0] \times \mathbb{R}$. The function w is continuous and bounded in $[0, T_0] \times \mathbb{R}$, and there are $\theta \in (0, 1)$ and $C' \geq 0$ such that $w|_{[0, T_0] \times \bar{I}}$ is of class $C_{t;x}^{1,\theta;2,\theta}([0, T_0] \times \bar{I})$ with

$$\|w|_{[0, T_0] \times \bar{I}}\|_{C_{t;x}^{1,\theta;2,\theta}([0, T_0] \times \bar{I})} \leq C' \quad (6.94)$$

for every patch $I \subset \mathbb{R}$. The function w still satisfies inequalities similar to (6.89) (with here $c \equiv 0$ and $F = f$) and (6.90) (with here the countably many interface points S , and $\sigma_i = \sigma$ for $x_i \in S_1$ and $\sigma_i = 1/\sigma$ for $x_i \in S_2$), together with $w(0, \cdot) = \bar{u}(0, \cdot) - \underline{u}(0, \cdot) \geq 0$ in \mathbb{R} . Let us consider an arbitrary $\varepsilon > 0$, and introduce an auxiliary function z defined by

$$z(t, x) := w(t, x) + \varepsilon(t + 1) \quad \text{for } (t, x) \in [0, T_0] \times \mathbb{R}.$$

The function z satisfies similar regularity estimates as w (even if it means replacing C' in (6.94) by another constant depending also on ε), while $z(0, x) \geq \varepsilon > 0$ for all $x \in \mathbb{R}$. Moreover, with the same notations as in (6.89) (with $c \equiv 0$ and $F = f$), one has

$$\mathcal{N}z(t, x) = \mathcal{N}w(t, x) + \varepsilon + (\mu - f_s(x, \eta(t, x)))\varepsilon(t + 1) \geq \varepsilon > 0 \quad \text{for } (t, x) \in [0, T_0] \times (\mathbb{R} \setminus S),$$

and (6.92) still holds from (6.90), at the interface points S . We claim that $z > 0$ in $[0, T_0] \times \mathbb{R}$. Assume not. Then, by continuity and the regularity estimates of z , there are $t_0 \in (0, T_0]$ and a sequence $(y_m)_{m \in \mathbb{N}}$ in \mathbb{R} such that $z(t_0, y_m) \rightarrow 0$ as $m \rightarrow +\infty$, and $z > 0$ in $[0, t_0] \times \mathbb{R}$. Let $\bar{y}_m \in (-l_1, l_2]$ be such that $y_m - \bar{y}_m \in l\mathbb{Z}$ and $\bar{y}_m \rightarrow \bar{y}_\infty \in [-l_1, l_2]$ as $m \rightarrow +\infty$, up to extraction of a subsequence. From the regularity estimates on z , there is a bounded continuous function $z_\infty : [0, T_0] \times \mathbb{R} \rightarrow \mathbb{R}$ such that $z_\infty|_{[0, T_0] \times \bar{I}} \in C_{t;x}^{1;2}([0, T_0] \times \bar{I})$ for each patch $I \subset \mathbb{R}$, and, up to extraction of a subsequence,

$$z(\cdot, \cdot + y_m - \bar{y}_m)|_{[0, T_0] \times \bar{I}} \rightarrow z_\infty|_{[0, T_0] \times \bar{I}} \quad \text{as } m \rightarrow +\infty \text{ in } C_{t;x}^{1;2}([0, T_0] \times \bar{I}),$$

for every patch $I \subset \mathbb{R}$. Moreover, $z_\infty \geq 0$ in $[0, t_0] \times \mathbb{R}$, and $z_\infty(t_0, \bar{y}_\infty) = 0$. Since the functions $d(x)$ and $f(x, s)$ are periodic with respect to x , the function z_∞ satisfies $(z_\infty)_t - d(x)(z_\infty)_{xx} + 2\mu z_\infty \geq \varepsilon > 0$ in $[0, t_0] \times (\mathbb{R} \setminus S)$, as well as the interface conditions (6.92) at the interface points S . The previous partial differential inequality satisfied by z_∞ implies that $\bar{y}_\infty \in S$ and that $z_\infty(t_0, \cdot) > 0$ in $\mathbb{R} \setminus S$. The Hopf lemma then yields $(z_\infty)_x(t_0, \bar{y}_\infty^+) > 0$ and $(z_\infty)_x(t_0, \bar{y}_\infty^-) < 0$, contradicting (6.92). As a consequence, $z > 0$ in $[0, T_0] \times \mathbb{R}$, hence $w \geq 0$ in $[0, T_0] \times \mathbb{R}$ due to the arbitrariness of $\varepsilon > 0$, and finally $\bar{u} \geq \underline{u}$ in $[0, T] \times \mathbb{R}$ due to the arbitrariness of $T_0 \in (0, T)$.

Lastly, if one further assumes that $\bar{u}(0, \cdot) \not\equiv \underline{u}(0, \cdot)$ in \mathbb{R} , then one concludes as in the proof of Proposition 6.23 that $\bar{u} > \underline{u}$ in $(0, T) \times \mathbb{R}$. \square

Chapter 7

Propagation and blocking in a two-patch reaction-diffusion model¹

7.1 Introduction

Propagation and propagation failure are two fundamental phenomena of great importance to many fields of science. For example, signal propagation in nerve cells occurs when the medium is homogeneous but can fail when inhomogeneities are present, such as a change in cross-sectional area, junctions to several other cells, or localized regions of reduced excitability [137, 110]. The mathematical framework of choice for modeling such phenomena are reaction-diffusion equations. In the simplest case, space is one-dimensional and inhomogeneities are represented as spatial changes in diffusivity or reaction terms at a single location, within a bounded region, or at periodically repeating locations. Our work here is inspired by the ecological dynamics of invasive species. When such species spread across a landscape, they encounter different habitat types, and their movement behavior as well as population dynamics may change according to landscape type. Our work is based on recent progress in modeling individual movement behaviors around interfaces where the landscape type changes [121] and continues the rigorous analysis of propagation phenomena in such models [94, 147].

Specifically, we consider a one-dimensional infinite landscape comprised of two semi-infinite patches. We denote $(-\infty, 0)$ as patch 1 and $(0, \infty)$ as patch 2. The interface that separates the two patches occurs at $x = 0$. Our model consists of a reaction-diffusion equation for the species' density on each patch and conditions that match the density and flux across the interface. We assume that each patch is homogeneous but the two patches may differ, so that the diffusion coefficients and the reaction terms (i.e. net population growth rates) may differ. Whereas most existing models for propagation and propagation failure assume that the

¹This is a joint work with François Hamel and Frithjof Lutscher, to be submitted.

7. Propagation and blocking in a two-patch reaction-diffusion model

population dynamics outside of a bounded region are identical, we are explicitly interested in the case where the dynamics differ, qualitatively and quantitatively, between the two patches. Hence, on each patch, the population density $u = u(x, t)$ satisfies an equation of the form

$$u_t = d_i u_{xx} + f_i(u), \quad (7.1)$$

where $i = 1, 2$, depending on patch type. Since we want the interface to be neutral with respect to reaction dynamics, (i.e. no individuals are born or die from crossing the interface), the density flux is continuous at the interface, i.e., $d_1 u_x(t, 0^-) = d_2 u_x(t, 0^+)$. Individuals at the interface may show a preference for one or the other patch type. We denote this preference by $\alpha \in (0, 1)$, where $\alpha > 0.5$ indicates a preference for patch 1 and $\alpha < 0.5$ for patch 2. Then the population density may be discontinuous at the interface with

$$(1 - \alpha)d_1 u(t, 0^-) = \alpha d_2 u(t, 0^+). \quad (7.2)$$

Please see [121] for a detailed derivation of this condition from a random walk and a thorough discussion of the biological implications. (A second case exists where both diffusion constants appear under square roots [121]; the theory developed below applies to that case as well.)

The discontinuity of the density at $x = 0$ creates some difficulties in the analysis of propagation phenomena in our equations. It turns out to be much easier to scale the equations so that the density is continuous; see [94] for details. Hence, in the present paper, we study the following two-patch problem:

$$\begin{cases} u_t = d_1 u_{xx} + f_1(u), & t > 0, x < 0, \\ u_t = d_2 u_{xx} + f_2(u), & t > 0, x > 0, \\ u(t, 0^-) = u(t, 0^+), & t > 0, \\ u_x(t, 0^-) = \sigma u_x(t, 0^+), & t > 0. \end{cases} \quad (7.3)$$

Here, the density is continuous across the interface but its derivative is not. The diffusion constants are assumed positive. Parameter $\sigma > 0$ is related to α , the probability that an individual at the interface chooses to move to patch 1. Please see Section 7.2.5 for more biological background and some interpretation of our results. Throughout this work, we shall assume that the functions f_i ($i = 1, 2$) are of class $C^1(\mathbb{R})$ and that

$$\exists 0 < K_i \leq K'_i, \quad f_i(0) = f_i(K_i) = 0, \quad \text{and} \quad f_i \leq 0 \text{ in } [K'_i, +\infty). \quad (7.4)$$

Our analysis and results will depend on a few characteristic properties of the functions f_i . We distinguish between the Fisher-KPP type (also KPP for short) and the bistable type. We give precise definitions of these properties below in (7.6) and (7.7), respectively.

In [94], we analyzed in full detail the well-posedness problem for a related patch model

in a one-dimensional spatially periodic habitat and also the spatial dynamics of the solution for the Cauchy problem under certain hypotheses on the reaction terms. Our goal of the present paper is to study spreading properties and propagation vs. blocking phenomena for the solutions of this two-patch model for various combinations of the reaction terms. Specifically, we shall investigate

1. the asymptotic spreading properties of the solutions to the Cauchy problem with compactly supported initial data when both reaction terms are of KPP type.
2. the conditions for the solutions to the Cauchy problem with compactly supported initial data to be blocked or to propagate with positive or zero speed when one reaction term is of KPP type and the other of bistable type. We shall also study the stability of the traveling wave in the bistable patch.
3. the asymptotic dynamics when both reaction terms are of bistable type.

Previous work on action potentials in nerve cells obtained some propagation and stability results when the reaction terms in both patches are identical and of bistable type and when the derivative is continuous at the interface, i.e., $\sigma = 1$ [137]. We also mention recent work on a bistable equation in multiple (three or more) disjoint half-lines with a junction [104]: the existence of entire (defined for all times $t \in \mathbb{R}$) solutions is proved and blocking phenomena of entire solutions caused by the emergence of certain stationary solutions are investigated.

Before we state our main results, we summarize some relevant results on the classical homogeneous reaction-diffusion equation

$$u_t = u_{xx} + f(u), \quad t > 0, \quad x \in \mathbb{R}, \quad (7.5)$$

where f is a $C^1(\mathbb{R})$ function satisfying $f(0) = f(1) = 0$. This equation has been extensively studied in the mathematical, physical, and biological literature since the pioneering works of Fisher [77] and Kolmogorov, Petrovskii and Piskunov [108] on population genetics. We say that f is of Fisher-KPP type (or simply KPP type) if

$$f(0) = f(1) = 0 \quad \text{and} \quad 0 < f(s) \leq f'(0)s \quad \text{for all } s \in (0, 1). \quad (7.6)$$

If f in (7.5) is of KPP type, (7.5) admits traveling front solutions $u(t, x) = \varphi_c(x \cdot e - ct)$ with $\varphi_c : \mathbb{R} \rightarrow (0, 1)$ and $\varphi_c(-\infty) = 1$, $\varphi_c(+\infty) = 0$, if and only if $c \geq c^* = 2\sqrt{f'(0)}$, where $e = \pm 1$ denotes the direction of propagation and c is the speed. For each $c \geq c^*$, φ_c satisfies

$$\varphi_c'' + c\varphi_c' + f(\varphi_c) = 0 \quad \text{in } \mathbb{R}, \quad \varphi_c' < 0 \quad \text{in } \mathbb{R}, \quad \varphi_c(-\infty) = 1, \quad \varphi_c(+\infty) = 0,$$

7. Propagation and blocking in a two-patch reaction-diffusion model

and it is unique up to shifts. Moreover, there holds

$$\varphi_c(s) \underset{s \rightarrow +\infty}{\sim} \begin{cases} Ae^{-\lambda_c s} & \text{if } c > c^*, \\ \tilde{A}s e^{-\lambda_c s} & \text{if } c = c^*, \end{cases}$$

where A, \tilde{A} are positive constants and the decay rate $\lambda_c > 0$ is obtained from the linearized equation $u_t = u_{xx} + f'(0)u$ and is given by $\lambda_c = (c - \sqrt{c^2 - 4f'(0)})/2$. It was proved in [36, 97, 109, 153] that the front with minimal speed c^* attracts, in some sense, the solutions of the Cauchy problem (7.5) associated with nonnegative bounded nontrivial compactly supported initial conditions $u_0 = u(0, \cdot)$. Furthermore, Aronson and Weinberger [9] proved that if $0 \leq u \leq 1$ is the solution to the Cauchy problem (7.5) with a nontrivial compactly supported initial datum $0 \leq u_0 \leq 1$, then $\sup_{\mathbb{R} \setminus (-ct, ct)} u(t, \cdot) \rightarrow 0$ as $t \rightarrow +\infty$ for every $c > c^*$, and $\inf_{[-ct, ct]} u(t, \cdot) \rightarrow 1$ as $t \rightarrow +\infty$ for every $c \in [0, c^*)$. We refer to these results as spreading properties. The minimal speed of traveling fronts, c^* , can therefore also be thought of as the asymptotic spreading speed.

In contrast, in the bistable case, defined as

$$f(0) = f(\theta) = f(1) = 0 \text{ for some } \theta \in (0, 1), f'(0) < 0, f'(1) < 0, f < 0 \text{ in } (0, \theta), f > 0 \text{ in } (\theta, 1), \quad (7.7)$$

(7.5) has traveling front solutions $u(t, x) = \phi(x \cdot e - ct)$, where $\phi : \mathbb{R} \rightarrow (0, 1)$, $\phi(-\infty) = 1$, $\phi(+\infty) = 0$, and $e = \pm 1$ is the direction of propagation, for a unique propagation speed $c \in \mathbb{R}$, depending only on f . Furthermore, the sign of c equals the sign of $\int_0^1 f(s) ds$ [9, 76]. The profile ϕ satisfies

$$\phi'' + c\phi' + f(\phi) = 0 \text{ in } \mathbb{R}, \phi' < 0 \text{ in } \mathbb{R}, \phi(-\infty) = 1, \phi(+\infty) = 0,$$

and is unique up to shifts. It is known that

$$\begin{cases} a_0 e^{-\alpha s} \leq \phi(s) \leq a_1 e^{-\alpha s}, & s \geq 0, \\ b_0 e^{\beta s} \leq 1 - \phi(s) \leq b_1 e^{\beta s}, & s < 0, \end{cases}$$

where a_0, a_1, b_0 and b_1 are some positive constants, α and β are given by $\alpha = (c + \sqrt{c^2 - 4f'(0)})/2 > 0$ and $\beta = (-c + \sqrt{c^2 - 4f'(1)})/2 > 0$ [76].

Fronts in the bistable case are globally stable in the sense that any solution of the Cauchy problem (7.5) with an initial condition $0 \leq u_0 \leq 1$ satisfying $\liminf_{x \rightarrow -\infty} u_0(x) > \theta > \limsup_{x \rightarrow +\infty} u_0(x)$ converges to the unique bistable traveling front $\phi(x - ct + \xi)$ uniformly in $x \in \mathbb{R}$ as $t \rightarrow +\infty$, where ξ is a real number depending only on u_0 and f [76]. The uniqueness of the speed c in the bistable case (7.7) is in sharp contrast with the KPP case (7.6) where the set of admissible speeds is a continuum $[c^*, +\infty)$ with $c^* = 2\sqrt{f'(0)}$.

Stationary solutions $u : \mathbb{R} \rightarrow [0, 1]$ of equation (7.5) in the bistable case (7.7) are either:

(a) constant solutions (zeros of f , that is, 0, θ or 1); or (b) periodic non-constant solutions; or (c) symmetrically decreasing solutions, namely, for some $x_0 \in \mathbb{R}$, $u(x) = u(2x_0 - x)$ in \mathbb{R} , $u' < 0$ in $(x_0, +\infty)$ and $u(\pm\infty) = 0$; or (d) symmetrically increasing solutions, namely, for some $x_0 \in \mathbb{R}$, $u(x) = u(2x_0 - x)$ in \mathbb{R} , $u' > 0$ in $(x_0, +\infty)$, and $u(\pm\infty) = 1$; or (e) strictly decreasing or increasing solutions converging to 0 and 1 at $\pm\infty$ [61, 76]. Case (c) (respectively case (d), respectively case (e)) occurs if and only if $\int_0^1 f(s)ds > 0$ (respectively $\int_0^1 f(s)ds < 0$, respectively $\int_0^1 f(s)ds = 0$). In the KPP case (7.6), the only stationary solutions $u : \mathbb{R} \rightarrow [0, 1]$ of (7.5) are the constants 0 and 1.

Many authors have studied extinction, blocking, and propagation results for the one-dimensional homogeneous equation (7.5), where extinction, blocking and propagation are understood in the following sense:

- *extinction*: $u(t, x) \rightarrow 0$ as $t \rightarrow +\infty$ uniformly in $x \in \mathbb{R}$;
- *blocking (say, in the right direction)*: $u(t, x) \rightarrow 0$ as $x \rightarrow +\infty$ uniformly in $t \geq 0$;
- *propagation*: $u(t, x) \rightarrow 1$ as $t \rightarrow +\infty$ locally uniformly in $x \in \mathbb{R}$.

Kanel' [107] considered the combustion nonlinearity (i.e., $f = 0$ in $[0, \theta] \cup \{1\}$ and $f > 0$ in $(\theta, 1)$ for some $0 < \theta < 1$) and showed that, for the particular family of initial conditions being characteristic functions of intervals (namely, $u_0 = \chi_{[-L, L]}$, with $L > 0$), there exist $0 < L_0 \leq L_1$ such that extinction occurs for $L < L_0$, while propagation occurs for $L > L_1$. This result was then extended by Aronson and Weinberger [8] to the bistable case (7.7) with $\int_0^1 f(s)ds > 0$ (so-called bistable unbalanced case). Zlatoš [162] improved these results in both cases by showing that $L_0 = L_1$. Du and Matano [61] generalized this sharp transition result for a wider class of one-parameter families of initial data. Moreover, they showed that the solutions to the Cauchy problem (7.5) with nonnegative bounded and compactly supported initial conditions always converge to a stationary solution of (7.5) as $t \rightarrow +\infty$ locally uniformly in $x \in \mathbb{R}$, and this limit turns out to be either a constant or a symmetrically decreasing stationary solution of (7.5). However, whether such a sharp criterion for extinction vs. propagation holds in our patch model (7.3) is a delicate issue, since there is no translation invariance due to the interface conditions at $x = 0$ and since the reaction terms and diffusion coefficients may differ in general. This question will be left for future work. Related results on propagation and blocking phenomena in inhomogeneous one-dimensional reaction-diffusion equations exist for either KPP reaction [21, 27, 81, 93, 96, 163] or bistable reaction [7, 47, 66, 68, 70, 93, 110, 127, 137].

To see the difficulties in our patchy setting, let us briefly recall the standard methods used for the one-dimensional reaction-diffusion equation (7.5). For the investigation of the Cauchy problem (7.5) with compactly supported initial conditions, reflection techniques can be effectively used to prove, among other things, the monotonicity of the solution $u(t, \cdot)$ outside any interval containing the initial support, see for instance [61, 62, 162]. Properties of the solutions to the parabolic equation (7.5) can also be connected with certain structures in the phase plane portrait of the ODE $u'' + f(u) = 0$. However, this is no longer the case

for the patch model (7.3). Instead, our proofs rest on comparison and PDE arguments. For instance, by estimating the behavior, for large $|x|$ and/or t , of the solution $u(t, x)$ of the Cauchy problem (7.3) with compactly supported initial conditions and then by comparing it with the standard traveling fronts, we can retrieve the classical spreading results [9, 76] in a sense (see Theorems 7.7, 7.16 and 7.26 below). Besides, in the KPP-bistable case (i.e. the case where f_1 is KPP and f_2 is bistable), we provide some sufficient conditions under which either blocking or propagation occurs in the bistable patch. At first glance, one may anticipate similar dynamics or features at large times for the solutions of the Cauchy problem (7.3) as for the solutions of the scalar homogeneous equation (7.5) in each patch, possibly with some nuances. However, that turns out to be not exactly true. We prove that the propagation phenomena in the KPP-bistable case can be remarkably different from what happens for the homogeneous bistable equation. We especially show a “virtual blocking” phenomenon, i.e., the solution indeed does propagate, but with speed zero, a situation which was previously investigated only in general inhomogeneous environments [124, 118]. This unusual phenomenon reveals that the effect of the KPP patch on the bistable patch cannot be neglected and that (7.3) is truly a coupled system of the reaction-diffusion equations.

7.2 Definitions and main results

Throughout the paper, we set

$$I_1 = (-\infty, 0) \quad \text{and} \quad I_2 = (0, +\infty).$$

By a solution of the Cauchy problem (7.3) associated with a continuous bounded initial condition u_0 , we mean a classical solution in the following sense [94].

Definition 7.1. *For $T \in (0, +\infty]$, we say that a continuous function $u : [0, T) \times \mathbb{R} \rightarrow \mathbb{R}$ is a classical solution of the Cauchy problem (7.3) in $[0, T) \times \mathbb{R}$ with an initial condition u_0 , if $u(0, \cdot) = u_0$ in \mathbb{R} , if $u|_{(0, T) \times \bar{I}_i} \in C_{t;x}^{1;2}((0, T) \times \bar{I}_i)$ ($i = 1, 2$), and if all identities in (7.3) are satisfied pointwise for $0 < t < T$.*

Similarly, by a classical stationary solution of (7.3), we mean a continuous function $U : \mathbb{R} \rightarrow \mathbb{R}$ such that $U|_{\bar{I}_i} \in C^2(\bar{I}_i)$ ($i = 1, 2$) and all identities in (7.3) are satisfied pointwise, but without any dependence on t .

We also define super- and subsolutions as follows.

Definition 7.2. *For $T \in (0, +\infty]$, we say that a continuous function $\bar{u} : [0, T) \times \mathbb{R} \rightarrow \mathbb{R}$, which is assumed to be bounded in $[0, T_0] \times \mathbb{R}$ for every $T_0 \in (0, T)$, is a supersolution of (7.3) in $[0, T) \times \mathbb{R}$, if $\bar{u}|_{(0, T) \times \bar{I}_i} \in C_{t;x}^{1;2}((0, T) \times \bar{I}_i)$ ($i = 1, 2$), if $\bar{u}_t(t, x) \geq d_i \bar{u}_{xx}(t, x) + f_i(\bar{u}(t, x))$*

for all $i = 1, 2$, $0 < t < T$ and $x \in I_i$, and if

$$\bar{u}_x(t, 0^-) \geq \sigma \bar{u}_x(t, 0^+) \text{ for all } t \in (0, T).$$

A subsolution is defined in a similar way with all the inequality signs above reversed.

7.2.1 Existence results for the Cauchy problem associated with (7.3)

Proposition 7.3 (Well-posedness of the Cauchy problem associated with (7.3)). *For any nonnegative bounded continuous function $u_0 : \mathbb{R} \rightarrow \mathbb{R}$, there is a unique nonnegative bounded classical solution u of (7.3) in $[0, +\infty) \times \mathbb{R}$ with initial condition u_0 such that, for any $\tau > 0$ and $A > 0$,*

$$\|u\|_{[\tau, +\infty) \times [-A, 0]} \|_{C_{t;x}^{1;\gamma;2;\gamma}([\tau, +\infty) \times [-A, 0])} + \|u\|_{[\tau, +\infty) \times [0, A]} \|_{C_{t;x}^{1;\gamma;2;\gamma}([\tau, +\infty) \times [0, A])} \leq C,$$

with a positive constant C depending on τ , A , $d_{1,2}$, $f_{1,2}$, σ and $\|u_0\|_{L^\infty(\mathbb{R})}$, and with a universal positive constant $\gamma \in (0, 1)$. Moreover, $u(t, x) > 0$ for all $(t, x) \in (0, +\infty) \times \mathbb{R}$ if $u_0 \not\equiv 0$. Lastly, the solutions depend monotonically and continuously on the initial data, in the sense that if $u_0 \leq v_0$ then the corresponding solutions satisfy $u \leq v$ in $[0, +\infty) \times \mathbb{R}$, and for any $T \in (0, +\infty)$ the map $u_0 \mapsto u$ is continuous from $C^+(\mathbb{R}) \cap L^\infty(\mathbb{R})$ to $C([0, T] \times \mathbb{R}) \cap L^\infty([0, T] \times \mathbb{R})$ equipped with the sup norms, where $C^+(\mathbb{R})$ denotes the set of nonnegative continuous functions in \mathbb{R} .

The existence in Proposition 7.3 can be proved by following the proof of [94, Theorem 2.2]. Namely, we can introduce a sequence of continuous cut-off functions $(\delta_n)_{n \in \mathbb{N}, n \geq 2}$ such that $0 \leq \delta_n \leq 1$ in \mathbb{R} , $\delta_n = 1$ in $[-n + 1, n - 1]$ and $\delta_n = 0$ in $\mathbb{R} \setminus (-n, n)$. As in [94, Section 3.1, Theorem 3.2], for each $n \geq 2$, there is a unique continuous function $u_n : [0, +\infty) \times [-n, n] \rightarrow \mathbb{R}$ such that $u_n|_{(0, +\infty) \times [-n, 0]} \in C_{t;x}^{1;2}((0, +\infty) \times [-n, 0])$, $u_n|_{(0, +\infty) \times [0, n]} \in C_{t;x}^{1;2}((0, +\infty) \times [0, n])$, and

$$\begin{cases} (u_n)_t = d_1(u_n)_{xx} + f_1(u_n), & t > 0, x \in [-n, 0), \\ (u_n)_t = d_2(u_n)_{xx} + f_2(u_n), & t > 0, x \in (0, n], \\ (u_n)_x(t, 0^-) = \sigma(u_n)_x(t, 0^+), & t > 0, \\ u_n(t, \pm n) = 0, & t \geq 0, \\ u_n(0, x) = \delta_n(x)u_0(x), & x \in [-n, n]. \end{cases}$$

Furthermore, $0 \leq u_n(t, x) \leq \max(K'_1, K'_2, \|u_0\|_{L^\infty(\mathbb{R})})$ for all $(t, x) \in [0, +\infty) \times [-n, n]$, with $K'_{1,2}$ as in (7.4). A comparison principle holds for the above truncated problem and, for each $(t, x) \in [0, +\infty) \times \mathbb{R}$, the sequence $(u_n(t, x))_{n \geq \max(2, |x|)}$ is nondecreasing. Next, as in [94, Section 3.2], the following properties hold: 1) there is $\gamma > 0$ such that, for every $A > 0$ and $\tau > 0$, the sequences $(u_n|_{[\tau, +\infty) \times [-A, 0]})_{n \geq \max(A, 2)}$ and $(u_n|_{[\tau, +\infty) \times [0, A]})_{n \geq \max(A, 2)}$ are bounded in

7. Propagation and blocking in a two-patch reaction-diffusion model

$C_{t;x}^{1,\gamma;2,\gamma}([\tau, +\infty) \times [-A, 0])$ and $C_{t;x}^{1,\gamma;2,\gamma}([\tau, +\infty) \times [0, A])$ respectively, by a constant depending only on $\tau, A, d_{1,2}, f_{1,2}, \sigma$ and $\|u_0\|_{L^\infty(\mathbb{R})}$; 2) the sequence $(u_n)_{n \in \mathbb{N}, n \geq 2}$ converge pointwise in $[0, +\infty) \times \mathbb{R}$ to a nonnegative bounded classical solution u of (7.3) with initial condition u_0 , in the sense of Definition 7.1; 3) the solutions u depend continuously on the initial conditions in the sense of Proposition 7.3. Lastly, the monotonicity with respect to the initial conditions and the uniqueness in Proposition 7.3 are consequences of the following comparison principle stated in [94, Proposition A.3].

Proposition 7.4 (Comparison principle). *For $T \in (0, +\infty]$, let \bar{u} and \underline{u} be, respectively, a super- and a subsolution of (7.3) in $[0, T) \times \mathbb{R}$ in the sense of Definition 6.10, and assume that $\bar{u}(0, \cdot) \geq \underline{u}(0, \cdot)$ in \mathbb{R} . Then, $\bar{u} \geq \underline{u}$ in $[0, T) \times \mathbb{R}$ and, if $\bar{u}(0, \cdot) \not\equiv \underline{u}(0, \cdot)$, then $\bar{u} > \underline{u}$ in $(0, T) \times \mathbb{R}$.*

In the sequel, when we speak of the solution u of (7.3) with a nonnegative bounded continuous initial condition u_0 , we always mean the unique nonnegative bounded classical solution u given in Proposition 7.3.

7.2.2 Propagation in the KPP-KPP case

We here investigate the spreading properties of the solutions to the Cauchy problem (7.3) associated with nonnegative, continuous and compactly supported initial conditions u_0 when f_i ($i = 1, 2$) in both patches I_i satisfy, in addition to (7.4), the KPP assumptions, that is,

$$f_i(0) = f_i(K_i) = 0, \quad 0 < f_i(s) \leq f'_i(0)s \text{ for all } s \in (0, K_i), \quad f'_i(K_i) < 0, \quad f_i < 0 \text{ in } (K_i, +\infty). \quad (7.8)$$

We call this configuration the KPP-KPP case. Without loss of generality, we assume that $K_1 \leq K_2$. In particular, if each function f_i satisfies (7.4) and is positive in $(0, K_i)$ and concave in $[0, +\infty)$, then (7.8) holds. An archetype is the logistic function $f_i(s) = s(1 - s/K_i)$.

We start with a Liouville-type result for the stationary problem associated with (7.3).

Proposition 7.5. *Under the assumption that*

$$f_i(0) = f_i(K_i) = 0, \quad f'_i(0) > 0, \quad f_i > 0 \text{ in } (0, K_i) \text{ and } f_i < 0 \text{ in } (K_i, +\infty), \quad (7.9)$$

with $0 < K_1 \leq K_2$, problem (7.3) admits a unique positive, bounded and classical stationary solution V . Furthermore, $V(-\infty) = K_1$, $V(+\infty) = K_2$, and $V' > 0$ in $(-\infty, 0^-] \cup [0^+, +\infty)$ if $K_1 < K_2$,² while $V \equiv K_1$ in \mathbb{R} if $K_1 = K_2$.

²The notation $V' > 0$ in $(-\infty, 0^-] \cup [0^+, +\infty)$ means that $V|_{(-\infty, 0]}$ and $V|_{[0, +\infty)}$ have positive first-order derivatives in $(-\infty, 0]$ and $[0, +\infty)$ respectively.

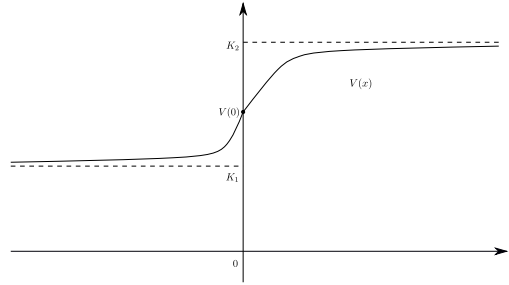

Figure 19: The profile of the unique positive stationary solution V in the KPP-KPP case.

The assumption (7.8) guarantees that the zero state is unstable with respect to any nontrivial perturbation, a phenomenon known from [9] as the hair-trigger effect for the homogeneous equation (7.5), and which holds here as well, as the following result shows:

Proposition 7.6. *Assume that (7.8) holds with $K_1 \leq K_2$. Then, the solution u of (7.3) with any nonnegative, bounded and continuous initial datum $u_0 \not\equiv 0$ satisfies:*

$$u(t, x) \rightarrow V(x) \quad \text{as } t \rightarrow +\infty, \text{ locally uniformly in } x \in \mathbb{R},$$

where V is the unique bounded continuous and classical stationary solution given in Proposition 7.5.

Our next main result in the KPP-KPP case is concerned with the spreading properties in both directions.

Theorem 7.7. *Assume that (7.8) holds and let V be as in Proposition 7.5. Then there exist leftward and rightward asymptotic spreading speeds, $c_1^* = 2\sqrt{d_1 f_1'(0)}$ and $c_2^* = 2\sqrt{d_2 f_2'(0)}$, respectively, such that the solution of (7.3) with any nonnegative, continuous and compactly supported initial condition $u_0 \not\equiv 0$ satisfies:*

$$\left\{ \begin{array}{l} \lim_{t \rightarrow +\infty} \left(\sup_{x \leq -(c_1^* + \varepsilon)t} u(t, x) \right) = \lim_{t \rightarrow +\infty} \left(\sup_{x \geq (c_2^* + \varepsilon)t} u(t, x) \right) = 0, \quad \text{for all } \varepsilon > 0, \\ \lim_{t \rightarrow +\infty} \left(\sup_{(-c_1^* + \varepsilon)t \leq x \leq (c_2^* - \varepsilon)t} |u(t, x) - V(x)| \right) = 0, \quad \text{for all } 0 < \varepsilon \leq \frac{c_1^* + c_2^*}{2}. \end{array} \right.$$

This theorem says that the level sets of $u(t, \cdot)$ behave as $2\sqrt{d_1 f_1'(0)}t$ in patch 1 and as $2\sqrt{d_2 f_2'(0)}t$ in patch 2 at large times, which is an analogue of the standard spreading result for the solutions to homogeneous KPP equations (7.5) (see, e.g. [9]), as already mentioned in the introduction. This demonstrates that, in the KPP-KPP case, the spreading speeds are essentially determined by the property of the equation at infinity.

7.2.3 Persistence, blocking or propagation in the KPP-bistable case

In this section, in addition to (7.4), we assume that f_1 is of KPP type, whereas f_2 is of bistable type, namely:

$$f_1(0) = f_1(K_1) = 0, \quad 0 < f_1(s) \leq f_1'(0)s \text{ for all } s \in (0, K_1), \quad f_1'(K_1) < 0, \quad f_1 < 0 \text{ in } (K_1, +\infty). \quad (7.10)$$

and

$$\begin{cases} f_2(0) = f_2(\theta) = f_2(K_2) = 0 \text{ for some } \theta \in (0, K_2), \\ f_2'(0) < 0, \quad f_2'(K_2) < 0, \quad f_2 < 0 \text{ in } (0, \theta) \cup (K_2, +\infty), \quad f_2 > 0 \text{ in } (\theta, K_2). \end{cases} \quad (7.11)$$

Let $\phi(x - c_2t)$ be the unique traveling wave solution connecting K_2 to 0 for the equation $u_t = d_2u_{xx} + f_2(u)$ viewed in the whole line \mathbb{R} , that is, $\phi : \mathbb{R} \rightarrow (0, K_2)$ satisfies

$$\begin{cases} d_2\phi'' + c_2\phi' + f_2(\phi) = 0, \quad \phi' < 0 \text{ in } \mathbb{R}, \\ \phi(-\infty) = K_2, \quad \phi(+\infty) = 0, \quad \phi(0) = \frac{K_2}{2}, \end{cases} \quad (7.12)$$

where the speed c_2 has the same sign as $\int_0^{K_2} f_2(s)ds$ [76]. The normalization condition $\phi(0) = K_2/2$ uniquely determines ϕ . Moreover,

$$\begin{cases} a_0e^{-\alpha s} \leq \phi(s) \leq a_1e^{-\alpha s}, \quad s \geq 0, \\ b_0e^{\beta s} \leq K_2 - \phi(s) \leq b_1e^{\beta s}, \quad s < 0, \end{cases} \quad (7.13)$$

where a_0, a_1, b_0 and b_1 are some positive constants, and α_0 and β_0 are given by

$$\alpha = \frac{c_2 + \sqrt{(c_2)^2 - 4d_2f_2'(0)}}{2d_2}, \quad \beta = \frac{-c_2 + \sqrt{(c_2)^2 - 4d_2f_2'(K_2)}}{2d_2}.$$

We will investigate the propagation phenomena for the solutions to the Cauchy problem (7.3) in this mixed KPP-bistable framework. We recall that for the scalar bistable equation, solutions may be blocked by the existence of certain steady states (see e.g. [11, 47, 49, 59, 60, 64, 69, 70, 93, 100, 110, 127, 137, 160] for various equations and geometric configurations). In our KPP-bistable setting, we will give sufficient conditions so that such blocking phenomena occur in patch 2, see Theorems 7.13–7.15. We point out that the ordering between K_1 and K_2 is considered here in complete generality. Besides, we also prove propagation and stability results inspired by Fife and McLeod [76], see Theorems 7.16–7.17. In particular, the “virtual blocking” phenomenon is investigated, see Theorem 7.17.

Persistence in the KPP patch 1

Before dealing with blocking or propagation in the bistable patch 2, we start with the following persistence and propagation result in the KPP patch 1. This result holds independently of the bistable profile in patch 2.

Theorem 7.8. *Assume that (7.10)–(7.11) hold. Let u be the solution of (7.3) with a nonnegative, continuous and compactly supported initial condition $u_0 \not\equiv 0$. Then, for every $\bar{x} \in \mathbb{R}$,*

$$\inf_{x \leq \bar{x}} \left(\liminf_{t \rightarrow +\infty} u(t, x) \right) > 0.$$

Moreover, u propagates to the left with speed $c_1^* = 2\sqrt{d_1 f_1'(0)}$ in the sense that

$$\left\{ \begin{array}{l} \forall \varepsilon > 0, \lim_{t \rightarrow +\infty} \left(\sup_{x \leq -(c_1^* + \varepsilon)t} u(t, x) \right) = 0, \\ \forall \varepsilon \in (0, c_1^*), \forall \eta > 0, \exists x_1 \in \mathbb{R}, \limsup_{t \rightarrow +\infty} \left(\sup_{-(c_1^* - \varepsilon)t \leq x \leq x_1} |u(t, x) - K_1| \right) < \eta. \end{array} \right.$$

In particular, $\sup_{-ct \leq x \leq -c't} |u(t, x) - K_1| \rightarrow 0$ as $t \rightarrow +\infty$ for every $0 < c' \leq c < c_1^*$.

Remark 7.9. For u as in Theorem 7.8, denote by $\omega(u)$ the ω -limit set of u in the topology of $C_{loc}^2(\mathbb{R})$. Recall that a function w belongs to $\omega(u)$ if and only if there exists a sequence $(t_k)_{k \in \mathbb{N}}$ diverging to $+\infty$ such that $\lim_{k \rightarrow +\infty} u(t_k, \cdot) = w$ in $C_{loc}^2(\mathbb{R})$. Proposition 7.3 implies that $\omega(u)$ is not empty and Theorem 7.8 yields $w(-\infty) = K_1$ for any $w \in \omega(u)$. Moreover, one can also conclude that, for each $\varepsilon \in (0, c_1^*)$ and each map $t \mapsto \zeta(t)$ such that $\zeta(t) \rightarrow -\infty$ and $|\zeta(t)| = o(t)$ as $t \rightarrow +\infty$, it holds

$$\lim_{t \rightarrow +\infty} \sup_{-(c_1^* - \varepsilon)t \leq x \leq \zeta(t)} |u(t, x) - K_1| = 0.$$

Stationary solutions connecting K_1 and 0, or K_1 and K_2

The following Proposition 7.10 provides some necessary conditions for a stationary solution connecting K_1 and 0 to exist, whereas Proposition 7.11 gives some sufficient conditions for such a solution to exist. These solutions will act as blocking barriers in the bistable patch 2 for the solutions of (7.3) with “small” initial conditions in some sense (see Theorem 7.15).

Proposition 7.10. *Assume that (7.10)–(7.11) hold, and that (7.3) admits a nonnegative classical stationary solution U such that $U(-\infty) = K_1$ and $U(+\infty) = 0$. Then one of the following cases holds:*

7. Propagation and blocking in a two-patch reaction-diffusion model

(i) if $\int_0^{K_2} f_2(s)ds < 0$, then $U' < 0$ in $(-\infty, 0^-] \cup [0^+, +\infty)$, $0 < U(0) < K_1$, and

$$\int_{U(0)}^{K_1} f_1(s)ds = -\frac{d_1\sigma^2}{d_2} \int_0^{U(0)} f_2(s)ds > 0; \quad (7.14)$$

(ii) if $\int_0^{K_2} f_2(s)ds = 0$, then $U' < 0$ in $(-\infty, 0^-] \cup [0^+, +\infty)$, $0 < U(0) < \min(K_1, K_2)$, and (7.14) holds;

(iii) if $\int_0^{K_2} f_2(s)ds > 0$ and if $\theta^* \in (\theta, K_2)$ is such that $\int_0^{\theta^*} f_2(s)ds = 0$, then:

(a) either $U' < 0$ in $(-\infty, 0^-] \cup [0^+, +\infty)$ and $0 < U(0) < \min(K_1, \theta^*)$,

(b) or U is bump-like, that is, U is nondecreasing in $(-\infty, x_0)$ and U is decreasing in $(x_0, +\infty)$ for some $x_0 \geq 0$, with $U(x_0) = \max_{\mathbb{R}} U = \theta^*$ and $U'(x_0) = 0$. Furthermore, either $x_0 > 0$, $U' > 0$ in $(-\infty, 0^-] \cup [0^+, x_0)$, $K_1 < U(0) < \theta^*$ and $U' < 0$ in $(x_0, +\infty)$; or $x_0 = 0$, $K_1 = \theta^*$, $U \equiv K_1$ in $(-\infty, 0]$, and $U' < 0$ in $(0, +\infty)$.

Proposition 7.11. *Assume that (7.10)–(7.11) hold. Then (7.3) admits a nonnegative classical stationary solution U such that $U(-\infty) = K_1$ and $U(+\infty) = 0$, provided one of the following holds:*

(i) $\int_0^{K_2} f_2(s)ds < 0$;

(ii) $\int_0^{K_2} f_2(s)ds = 0$ and $K_1 < K_2$;

(iii) $\int_0^{K_2} f_2(s)ds > 0$ and $K_1 \leq \theta^*$, where $\theta^* \in (\theta, K_2)$ is such that $\int_0^{\theta^*} f_2(s)ds = 0$.

Proposition 7.11 is optimal in the sense that the parameters $d_{1,2}$ and σ are not involved. However, when $\int_0^{K_2} f_2(s)ds = 0$ and $K_1 \geq K_2$, or when $\int_0^{K_2} f_2(s)ds > 0$ and $K_1 > \theta^*$, it turns out that the stationary solution U of (7.3) such that $U(-\infty) = K_1$ and $U(+\infty) = 0$ may not exist, and then the parameters $f_{1,2}$, $d_{1,2}$ and σ play crucial roles (see the comments after the proof of Proposition 7.11 in Section 7.4.2 below for further details).

The third proposition, which will play a key-role in the large-time dynamics of the spreading solutions in patch 2, is the analogue of Proposition 7.5 in the present KPP-bistable framework, namely it is concerned with the stationary solutions of (7.3) connecting K_1 and K_2 .

Proposition 7.12. *Assume that (7.10)–(7.11) hold and that $\int_0^{K_2} f_2(s)ds \geq 0$. Then problem (7.3) has a unique, nonnegative, bounded and classical stationary solution V such that $V(-\infty) = K_1$ and $V(+\infty) = K_2$. Moreover, V is monotone in \mathbb{R} .*

Notice that the functions U and V given in Propositions 7.11 and 7.12 can exist simultaneously, since the sufficient conditions for the existence of U and V are not incompatible.

Blocking phenomena if patch 2 has bistable dynamics

We now turn to investigate blocking phenomena. If U is a stationary solution of (7.3) with $U(-\infty) = K_1$ and $U(+\infty) = 0$ and if the nonnegative bounded continuous initial condition u_0 satisfies $0 \leq u_0 \leq U$ in \mathbb{R} , then the comparison principle [94, Proposition A.3] implies that the solution u of the Cauchy problem (7.3) with initial condition u_0 satisfies $0 \leq u(t, x) \leq U(x)$ for all $(t, x) \in [0, +\infty) \times \mathbb{R}$, hence it is blocked in patch 2, that is,

$$u(t, x) \rightarrow 0 \text{ as } x \rightarrow +\infty, \text{ uniformly in } t \geq 0. \quad (7.15)$$

For another blocking result, we assume that $\int_0^{K_2} f_2(s)ds \leq 0$ and show that the traveling front solution $\phi(x - c_2t)$ of (7.12) serves as a blocking barrier in patch 2.

Theorem 7.13. *Assume that (7.10)–(7.11) hold, and that $\int_0^{K_2} f_2(s)ds < 0$, or $\int_0^{K_2} f_2(s)ds = 0$ with $K_1 < K_2$. Let u be the solution of (7.3) with a nonnegative, continuous and compactly supported initial condition $u_0 \not\equiv 0$. Then, u is blocked in patch 2, that is, it satisfies (7.15).*

Furthermore, blocking can occur when K_1 and the $L^\infty(\mathbb{R})$ norm of u_0 are less than θ .

Theorem 7.14. *Assume that (7.10)–(7.11) hold and that $K_1 < \theta$. Let u be the solution of (7.3) with a nonnegative, continuous and compactly supported initial condition $u_0 \not\equiv 0$ such that $u_0 < \theta$ in \mathbb{R} . Then, u is blocked in patch 2, that is, it satisfies (7.15).*

Our last blocking result requires that the initial conditions u_0 is small in the $L^1(\mathbb{R})$ norm and that a classical stationary solution exists, connecting K_1 and 0.

Theorem 7.15. *Assume that (7.10)–(7.11) hold and that (7.3) admits a nonnegative classical stationary solution U with $U(-\infty) = K_1$ and $U(+\infty) = 0$. Then, for any $L > 0$, there is $\varepsilon > 0$ such that the following holds: for any nonnegative continuous initial condition u_0 whose support is included in $[-L, L]$ and which is such that $\|u_0\|_{L^1(\mathbb{R})} \leq \varepsilon$, the solution u of (7.3) with initial condition u_0 is blocked in patch 2, that is, it satisfies (7.15).*

Notice that, in contrast with Theorem 7.13 which is concerned with the case $\int_0^{K_2} f_2(s)ds \leq 0$, Theorems 7.14–7.15 show that blocking can also occur when $\int_0^{K_2} f_2(s)ds > 0$ (in particular, the existence of U in Theorem 7.15 can be fulfilled when $\int_0^{K_2} f_2(s)ds > 0$, as follows from Proposition 7.11).

Propagation with positive or zero speed when patch 2 has bistable dynamics

Finally, we turn to propagation results in patch 2. Our first result is motivated by the one-dimensional propagation result of Fife and McLeod [76]. They showed that solutions of the homogeneous Cauchy problem (7.3) with bistable nonlinearity (7.11) and compactly supported initial conditions spread with positive speed in both directions if (i) the initial conditions exceed θ on a large enough set and (ii) $\int_0^{K_2} f_2(s)ds > 0$.

7. Propagation and blocking in a two-patch reaction-diffusion model

Theorem 7.16. *Assume that (7.10)–(7.11) hold and that $\int_0^{K_2} f_2(s)ds > 0$. Let u be the solution of (7.3) with a nonnegative, continuous and compactly supported initial datum $u_0 \not\equiv 0$. Then, for any $\eta > 0$, there is $L > 0$ such that, if $u_0 \geq \theta + \eta$ on an interval of size L included in patch 2, then u propagates to the right with speed c_2 and, more precisely, there is $\xi \in \mathbb{R}$ such that*

$$\sup_{t \geq A, x \geq A} |u(t, x) - \phi(x - c_2 t + \xi)| \rightarrow 0 \quad \text{as } A \rightarrow +\infty, \quad (7.16)$$

where ϕ is the traveling front profile given by (7.12).

The result in the preceding theorem assumes some conditions on f_2 and u_0 . The following result shows that propagation can also occur independently of u_0 and under some slightly weaker assumptions on f_2 , provided no stationary solution connecting K_1 and 0 exists.

Theorem 7.17. *Assume that (7.10)–(7.11) hold and that $\int_0^{K_2} f_2(s)ds \geq 0$. If (7.3) has no nonnegative classical stationary solution U such that $U(-\infty) = K_1$ and $U(+\infty) = 0$, then the solution u of (7.3) with any nonnegative, continuous and compactly supported initial condition $u_0 \not\equiv 0$ propagates completely, namely,*

$$u(t, x) \rightarrow V(x) \quad \text{as } t \rightarrow +\infty, \quad \text{locally uniformly in } x \in \mathbb{R}, \quad (7.17)$$

where V is the unique nonnegative classical stationary solution of (7.3) such that $V(-\infty) = K_1$ and $V(+\infty) = K_2$, given in Proposition 7.12. Furthermore,

- (i) if $\int_0^{K_2} f_2(s)ds > 0$, then u propagates to the right with speed $c_2 > 0$ in patch 2, and more precisely (7.16) holds for some $\xi \in \mathbb{R}$;
- (ii) if $\int_0^{K_2} f_2(s)ds = 0$, then u propagates to the right with speed zero in patch 2, in the sense that (7.17) holds and $\sup_{x \geq ct} u(t, x) \rightarrow 0$ as $t \rightarrow +\infty$ for every $c > 0$.

Remark 7.18. In the balanced case

$$\int_0^{K_2} f_2(s)ds = 0, \quad (7.18)$$

blocking in patch 2 can occur, as follows from Theorems 7.13–7.15. However, in contrast to the case $\int_0^{K_2} f_2(s)ds < 0$ (see Theorem 7.13), blocking is not guaranteed. Indeed, if (7.18) holds, Proposition 7.10 (ii) and Theorem 7.17 (ii) provide some sufficient conditions for the solution u of (7.3) to propagate to the right with speed zero. These conditions are fulfilled, for instance, when we replace f_2 in (7.11) with \tilde{f}_2 , where $f_2(s) = \tilde{f}_2(s/\varepsilon)$ and choose $\varepsilon > 0$ small enough while all other parameters are fixed. We give a heuristic explanation for this phenomenon. First, it follows from Proposition 7.11 that $K_1 \geq K_2$ under the assumptions

of Theorem 7.17 (ii). Then, since $u(t, x)$ converges as $t \rightarrow +\infty$ locally uniformly in $x \in \mathbb{R}$ to the stationary solution V connecting K_1 and K_2 , the KPP patch provides exterior energy through the interface and forces the solution u to persist in patch 2 and then propagate with zero speed. A similar phenomenon, called “virtual blocking” or “virtual pinning”, was previously investigated in a one-dimensional heterogeneous bistable equation [124] and in the mean curvature equation in two-dimensional sawtooth cylinders [118]. It is also well known that for the homogeneous bistable equation (7.5), the solution u to the Cauchy problem with any nonnegative bounded compactly supported initial condition is blocked at large times and extinction occurs when (7.18) holds. In contrast, Theorem 7.17 states that, when (7.18) is fulfilled, the solution to the patch problem (7.3) with a compactly supported initial condition can still propagate into the bistable patch 2, but its level sets then move to the right with speed zero.

Remark 7.19. When the initial condition of the scalar homogeneous bistable equation (7.5) is small in the $L^1(\mathbb{R})$ norm, then $\|u(1, \cdot)\|_{L^\infty(\mathbb{R})}$ can be bounded from above by a constant less than θ . Hence, extinction occurs and the blocking property (7.15) holds if the initial condition is compactly supported. In our work, due to the presence of the KPP patch 1 in (7.3), a small $L^1(\mathbb{R})$ norm of the initial condition is not sufficient to cause blocking for equations (7.3) in general, as follows from Theorems 7.16–7.17.

7.2.4 Blocking or propagation in the bistable-bistable case

In this section, we briefly show some extension of the results for the KPP-bistable case to the bistable-bistable case.

Assume that f_i ($i = 1, 2$) are of bistable type:

$$\begin{cases} f_i(0) = f_i(\theta_i) = f_i(K_i) = 0 \text{ for some } \theta_i \in (0, K_i), \\ f'_i(0) < 0, f'_i(K_i) < 0, f_i < 0 \text{ in } (0, \theta_i), f_i > 0 \text{ in } (\theta_i, K_i). \end{cases} \quad (7.19)$$

Let $\phi_i(-x \cdot e_i - c_i t)$ with $e_i = \pm 1$ ($i = 1, 2$) be the unique traveling waves connecting K_i to 0 for the equation $u_t = d_i u_{xx} + f_i(u)$ viewed in the whole line \mathbb{R} , that is, $\phi_i : \mathbb{R} \rightarrow (0, K_i)$ satisfies

$$\begin{cases} d_i \phi_i'' + c_i \phi_i' + f_i(\phi_i) = 0, & \phi_i' < 0 \text{ in } \mathbb{R}, \\ \phi_i(-\infty) = K_i, \phi_i(+\infty) = 0, \phi_i(0) = \theta_i, \end{cases} \quad (7.20)$$

where the speeds c_i have the sign of $\int_0^{K_i} f_i(s) ds$ [76] (the normalization condition $\phi(0) = K_i/2$ uniquely determine ϕ_i). Moreover, ϕ_i have similar exponential estimates to (7.13).

7. Propagation and blocking in a two-patch reaction-diffusion model

Stationary solutions connecting K_1 and 0, or K_1 and K_2

First of all, in the spirit of Proposition 7.10, we provide some necessary conditions such that a stationary solution connecting K_1 and 0 exists. Namely,

Proposition 7.20. *Assume that (7.19) holds and $\int_0^{K_1} f_1(s)ds \geq 0$, and that (7.3) admits a nonnegative classical stationary solution U such that $U(-\infty) = K_1$ and $U(+\infty) = 0$. Then one of the following cases holds true:*

(i) *If $\int_0^{K_2} f_2(s)ds < 0$, then $U' < 0$ in $(-\infty, 0^-] \cup [0^+, +\infty)$ and $0 < U(0) < K_1$, and*

$$\int_{U(0)}^{K_1} f_1(s)ds = -\frac{d_1\sigma^2}{d_2} \int_0^{U(0)} f_2(s)ds > 0; \quad (7.21)$$

(ii) *If $\int_0^{K_2} f_2(s)ds = 0$, then $U' < 0$ in $(-\infty, 0^-] \cup [0^+, +\infty)$ and $0 < U(0) < \min(K_1, K_2)$, and (7.21) holds;*

(iii) *If $\int_0^{K_2} f_2(s)ds > 0$ and let $\theta_2^* \in (\theta_2, K_2)$ be such that $\int_0^{\theta_2^*} f_2(s)ds = 0$, then:*

(a) *either $U' < 0$ in $(-\infty, 0^-] \cup [0^+, +\infty)$ and $0 < U(0) < \min(K_1, \theta_2^*)$,*

(b) *or U is bump-like, that is, U is nondecreasing in $(-\infty, x_0)$ and U is decreasing in $(x_0, +\infty)$ for some $x_0 \geq 0$, with $U(x_0) = \max_{\mathbb{R}} U = \theta_2^*$ and $U'(x_0) = 0$. Furthermore, either $x_0 > 0$, $U' > 0$ in $(-\infty, 0^-] \cup [0^+, x_0)$, $K_1 < U(0) < \theta_2^*$ and $U' < 0$ in $(x_0, +\infty)$; or $x_0 = 0$, $K_1 = \theta_2^*$, $U \equiv K_1$ in $(-\infty, 0]$, and $U' < 0$ in $(0, +\infty)$.*

By a slight modification of the proof of Proposition 7.11, some sufficient conditions such that a stationary solution connecting K_1 and 0 exists are obtained as follows.

Proposition 7.21. *Assume that (7.19) holds and that $\int_0^{K_1} f_1(s)ds \geq 0$. Then (7.3) admits a nonnegative classical stationary solution U such that $U(-\infty) = K_1$ and $U(+\infty) = 0$, provided one of the following holds:*

(i) $\int_0^{K_2} f_2(s)ds < 0$;

(ii) $\int_0^{K_2} f_2(s)ds = 0$ and $K_1 < K_2$;

(iii) $\int_0^{K_2} f_2(s)ds > 0$ and $K_1 \leq \theta_2^*$, where $\theta_2^* \in (\theta_2, K_2)$ is such that $\int_0^{\theta_2^*} f_2(s)ds = 0$.

Similar to Proposition 7.12, we also have:

Proposition 7.22. *Assume that (7.19) holds and that $\int_0^{K_i} f_i(s)ds \geq 0$ for $i = 1, 2$. Then problem (7.3) has a unique, nonnegative, bounded and classical stationary solution V such that $V(-\infty) = K_1$ and $V(+\infty) = K_2$. Moreover, V is monotone in \mathbb{R} .*

The strategy of the proof of Proposition 7.22 is very similar to that of Proposition 7.12, however, the argument in Step 2.1 this time should follow the idea of Step 2.2 due to the bistable assumption on f_1 .

Blocking phenomena

Following the lines as that of Theorem 7.13, one has:

Theorem 7.23. *Assume that (7.19) holds and let u be the solution of (7.3) with nonnegative, continuous and compactly supported initial function $u_0 \not\equiv 0$. Then,*

(i) *if there is $i \in \{1, 2\}$ such that $\int_0^{K_i} f_i(s)ds < 0$, then u will be blocked in patch i , that is,*

$$u(t, x) \rightarrow 0 \text{ as } |x| \rightarrow +\infty \text{ in patch } i, \text{ uniformly in } t \geq 0;$$

(ii) *if $\int_0^{K_1} f_1(s)ds > 0$ and $\int_0^{K_2} f_2(s)ds = 0$ with $K_1 < K_2$, then u is blocked in patch 2, that is, it satisfies (7.15). Furthermore, if for any $\eta > 0$, there is $L > 0$ such that $u_0 \geq \theta + \eta$ on an interval of size L included in patch 1, then u propagates to the left with speed c_1 and, more precisely, there is $\xi \in \mathbb{R}$ such that*

$$\sup_{t \geq A, x \leq -A} |u(t, x) - \phi_1(-x - c_1 t + \xi)| \rightarrow 0 \text{ as } A \rightarrow +\infty, \quad (7.22)$$

where ϕ_1 is the traveling front profile given by (7.20).

Finally, similar to Theorem 7.14, one has

Theorem 7.24. *Assume that (7.19) holds, $\int_0^{K_1} f_1(s)ds \geq 0$ and $K_1 < \theta_2$. Let u be the solution of (7.3) with nonnegative, continuous and compactly supported initial value $u_0 \not\equiv 0$ such that $u_0 < \theta_2$ in \mathbb{R} . Then u is blocked in patch 2, that is, it satisfies (7.15).*

From Theorem 7.15, it follows that

Theorem 7.25. *Assume that (7.19) holds and $\int_0^{K_1} f_1(s)ds \geq 0$, and that (7.3) admits a nonnegative classical stationary solution U such that $U(-\infty) = K_1$ and $U(+\infty) = 0$. Then, for any $L > 0$, there is $\varepsilon > 0$ such that the following holds: for any nonnegative continuous and compactly supported initial condition u_0 whose support is included in $[-L, L]$ and which is such that $\|u_0\|_{L^1(\mathbb{R})} \leq \varepsilon$, the solution u of (7.3) with initial condition u_0 is blocked in patch 2, that is, it satisfies (7.15).*

Propagation with positive or zero speed

The following theorems are concerned with propagation results. From Theorem 7.16, it is easy to see that:

7. Propagation and blocking in a two-patch reaction-diffusion model

Theorem 7.26. *Assume that (7.19) holds and that there is $i \in \{1, 2\}$ such that $\int_0^{K_i} f_i(s)ds > 0$. Let u be the solution of (7.3) with nonnegative, continuous and compactly supported initial function $u_0 \not\equiv 0$. Then, for any $\eta > 0$, there is $L > 0$ such that, if $u_0 \geq \theta_i + \eta$ on an interval of size L included in patch i , then u propagates in patch i with speed c_i and more precisely, there is $\xi_i \in \mathbb{R}$ such that*

$$\sup_{t \geq A, -x \cdot e_i \geq A} |u(t, x) - \phi_i(-x \cdot e_i - c_i t + \xi_i)| \rightarrow 0 \text{ as } A \rightarrow +\infty, \quad (7.23)$$

where ϕ_i is the traveling front profile given by (7.20).

Inspired from Theorem 7.17, we have

Theorem 7.27. *Assume that (7.19) holds and that $\int_0^{K_1} f_1(s)ds > 0$ and $\int_0^{K_2} f_2(s)ds \geq 0$. If (7.3) has no nonnegative classical stationary solution U such that $U(-\infty) = K_1$ and $U(+\infty) = 0$. Let u be the solution of (7.3) with nonnegative continuous and compactly supported initial datum $u_0 \not\equiv 0$. Then, for any $\eta > 0$, there is $L > 0$ such that, if $u_0 \geq \theta_1 + \eta$ on an interval of size L included in patch 1, then u propagates completely, namely,*

$$u(t, x) \rightarrow V(x) \text{ as } t \rightarrow +\infty, \text{ locally uniformly in } x \in \mathbb{R}, \quad (7.24)$$

where V is the unique nonnegative classical stationary solution of (7.3) such that $V(-\infty) = K_1$ and $V(+\infty) = K_2$, given in Proposition 7.22. Furthermore, u propagates to the left with speed c_1 and (7.23) with $i = 1$ holds true in patch 1, and the following holds true in patch 2:

- (i) if $\int_0^{K_2} f_2(s)ds > 0$, then u propagates to the right with speed $c_2 > 0$, and more precisely (7.23) with $i = 2$ holds for some $\xi \in \mathbb{R}$;
- (ii) if $\int_0^{K_2} f_2(s)ds = 0$, then u propagates to the right with speed zero, in the sense that (7.17) holds and $\sup_{x \geq ct} u(t, x) \rightarrow 0$ as $t \rightarrow +\infty$ for every $c > 0$.

7.2.5 Biological interpretation and explanation

We briefly discuss our results from an ecological point of view here. We envision a landscape of two different characteristics, say a large wooded area and an adjacent open grassland area. We assume that the movement rates of individuals are small relative to landscape scale so that we can essentially consider each landscape type as infinitely large. In the first scenario (KPP–KPP), the population has its highest growth rate at low density in both patches. While the low-density growth rates and carrying capacities may differ between the two landscape types, the population will grow in each type from low densities to the carrying capacity. When introduced locally, the population will spread in both directions, and the speed of spread will approach the famous Fisher speed $2\sqrt{d_i f'_i(0)}$ in each patch. The interface will

not stop the population advance unless it is completely impermeable. This would be the special case (that we excluded from our analysis) where an individual at the interface will choose one of the two habitat types with probability one, i.e., $\alpha = 0$ or $\alpha = 1$.

The second scenario (KPP–bistable) is more interesting. This time, the population dynamics change qualitatively from the highest growth rate being at low density to being at intermediate density. In ecological terms, this corresponds to a strong Allee effect and the threshold value θ is known as the Allee threshold. In this case, the interface can prevent a population that is spreading in the one habitat type (without Allee dynamic) from continuing to spread in the other type (with Allee dynamics). At first glance, it seems surprising that the conditions for propagation failure do not include parameter σ that reflects the movement behavior at the interface. To understand the reasons, we need to understand the scaling that led to system (7.3). The scaled reaction function f_2 and its unscaled counterpart, say \tilde{f}_2 , are related via

$$f_2(s) = k\tilde{f}_2(s/k), \quad k = \frac{\alpha}{1 - \alpha} \frac{d_2}{d_1},$$

see [94]. In particular, if \tilde{K}_2 and $\tilde{\theta}$ are the unscaled carrying capacity and Allee threshold, then $K_2 = k\tilde{K}_2$ and $\theta = k\tilde{\theta}$ are the corresponding scaled quantities. The sign of the integral that determines the sign of the speed of propagation in the homogeneous bistable equation does not change under this scaling. Hence, by choosing k large enough, one can satisfy the condition $K_1 < \theta$ in Theorem 7.14. A population that starts on a bounded set inside the KPP patch will be bounded by K_1 and therefore unable to spread in the Allee patch. Large values of k arise when the preference for patch 1 is high ($\alpha \approx 1$) or when the diffusion rate in the Allee patch is much larger than in the KPP patch. The mechanisms in this last scenario is similar to that when a population spreads from an narrow into a wide region in two or three dimensions [49]. As individuals diffuse broadly, their density drops below the Allee threshold and the population cannot reproduce and spread.

A change in population dynamics from KPP to Allee effect need not be triggered by landscape properties, it can also be induced by management measures. For example, when male sterile insects are released in large enough densities, the probability of a female insect to meet a non-sterile male decreases substantially so that a mate-finding Allee effect may arise. The use of this technique to create barrier zones for insect pest spread has recently been explored by related but different means [3].

Outline of this chapter. In Section 7.3, we consider (7.3) with KPP-KPP reactions and prove Propositions 7.5–7.6 and Theorem 7.7. Section 7.4 is devoted to the KPP-bistable case. We begin by proving the semi-persistence result Theorem 7.8 in Section 7.4.1. Then, in Section 7.4.2, we present the proofs of Propositions 7.10–7.12. In Sections 7.4.3 and 7.4.4, we collect the proofs of the main results on blocking, virtual blocking and propagation in patch 2, namely, Theorems 7.13–7.17. In Section 7.5, we sketch the essential parts of the proofs in the bistable-bistable case which are different from those in the KPP-bistable case.

7.3 The KPP-KPP case

This section is dedicated to the analysis of (7.3) with KPP-KPP reactions. We start with proving Proposition 7.5 for the stationary problem associated with (7.3).

Proof of Proposition 7.5. The existence of the stationary solution follows immediately from the existence of a pair of ordered sub- and supersolution. Indeed, from (7.9), it is easy to check that K_1 and K_2 are, respectively, a sub- and a supersolution for the stationary problem of (7.3). Hence, there exists a stationary solution V to (7.3) such that $K_1 \leq V(x) \leq K_2$ for $x \in \mathbb{R}$.

Next, let us turn to the uniqueness. Consider any nonnegative bounded classical stationary solution V of (7.3). If there is $x_0 \in (-\infty, 0)$ such that $V(x_0) = 0$, then $V \equiv 0$ in $(-\infty, 0)$ from the elliptic strong maximum principle, and then in $(-\infty, 0]$ by continuity of V . If $V > 0$ in $(-\infty, 0)$ and $V(0) = 0$, then it follows from the Hopf lemma that $V'(0^-) < 0$. Similarly, if there is $x_0 \in (0, +\infty)$ such that $V(x_0) = 0$, then $V \equiv 0$ in $(0, +\infty)$ from the elliptic strong maximum principle, and then in $[0, +\infty)$ by continuity of V . If $V > 0$ in $(0, +\infty)$ and $V(0) = 0$, then the Hopf lemma implies $V'(0^+) > 0$. From these observations and the fact that $V(0^-) = \sigma V'(0^+)$ with $\sigma > 0$, it follows that either $V \equiv 0$ in \mathbb{R} , or $V > 0$ in \mathbb{R} . In the sequel, we assume that $V > 0$ in \mathbb{R} .

We first claim that $\inf_{\mathbb{R}} V > 0$ and

$$V(-\infty) = K_1, \quad V(+\infty) = K_2. \quad (7.25)$$

As a matter of fact, since $f'_i(0) > 0$ ($i = 1, 2$), one can choose $R > 0$ so large that

$$0 < \frac{\pi}{2R} \leq \sqrt{\frac{\min(f'_1(0), f'_2(0))}{2 \max(d_1, d_2)}}. \quad (7.26)$$

Set

$$w(x) = \begin{cases} \cos(\frac{\pi}{2R}x), & \text{in } (-R, R), \\ 0, & \text{otherwise.} \end{cases} \quad (7.27)$$

Then there exists $\tilde{\varepsilon} > 0$ such that the function εw satisfies $-d_i(\varepsilon w)'' \leq f_i(\varepsilon w)$ in \mathbb{R} for $i = 1, 2$ and for $0 < \varepsilon \leq \tilde{\varepsilon}$, due to the assumption that $f_i(0) = 0$ and $f'_i(0) > 0$ ($i = 1, 2$). Fix $x_0 = -R - 1$, one can choose $\varepsilon_0 \in (0, \tilde{\varepsilon}]$ such that

$$V > \varepsilon_0 w(\cdot - x_0) \text{ in } \mathbb{R}. \quad (7.28)$$

Then, by continuity of $V - \varepsilon_0 w$, there is $s_0 > 1$ such that

$$V > \varepsilon_0 w(\cdot - sx_0) \text{ in } [sx_0 - R, sx_0 + R] \text{ for all } s \in [1, s_0].$$

Define

$$s^* = \sup\{\tilde{s} > 1 : V > \varepsilon_0 w(\cdot - sx_0) \text{ in } [sx_0 - R, sx_0 + R] \text{ for all } s \in [1, \tilde{s}]\}.$$

It is obvious to see that $s^* \geq s_0$. We wish to prove that $s^* = +\infty$. Assume not. By the definition of s^* , one has $V \geq \varepsilon_0 w(\cdot - s^*x_0)$ in $[s^*x_0 - R, s^*x_0 + R]$ and there is $\hat{x} \in [s^*x_0 - R, s^*x_0 + R]$ such that $V(\hat{x}) = \varepsilon_0 w(\hat{x} - s^*x_0)$. Since $V > 0$ in \mathbb{R} and $w(\cdot - s^*x_0) = 0$ at $x = s^*x_0 \pm R$, one derives that $\hat{x} \in (s^*x_0 - R, s^*x_0 + R)$. The elliptic strong maximum principle then yields that $V \equiv \varepsilon_0 w(\cdot - s^*x_0)$ in $[s^*x_0 - R, s^*x_0 + R]$. This is impossible. Consequently, $s^* = +\infty$. This implies

$$V > \varepsilon_0 w(\cdot - sx_0) \text{ in } [sx_0 - R, sx_0 + R] \text{ for all } s \geq 1.$$

whence $\inf_{x \leq -R-1} V > \varepsilon_0$. Similarly, one can also show that $\inf_{x \geq R+1} V > \varepsilon_1$ for some $\varepsilon_1 \in (0, \tilde{\varepsilon}]$. Moreover, since $V > 0$ in \mathbb{R} , we see that $\varepsilon_2 := \min_{|x| \leq R+1} V > 0$. Consequently, we get $\inf_{\mathbb{R}} V \geq \min(\varepsilon_0, \varepsilon_1, \varepsilon_2) > 0$.

Consider now an arbitrary sequence $(x_n)_{n \in \mathbb{N}}$ in \mathbb{R} diverging to $-\infty$ as $n \rightarrow +\infty$ and define $V_n := V(\cdot + x_n)$ in \mathbb{R} for each $n \in \mathbb{N}$. Then by standard elliptic estimates, the sequence $(V_n)_{n \in \mathbb{N}}$ converges as $n \rightarrow +\infty$, up to extraction of some subsequence, in $C_{loc}^2(\mathbb{R})$ to a bounded function V_1 which solves $d_1 V_1'' + f_1(V_1) = 0$ in \mathbb{R} . Moreover, $V_1 \geq \min(\varepsilon_0, \varepsilon_1, \varepsilon_2) > 0$ in \mathbb{R} . On the other hand, it is known that $d_1 u'' + f_1(u) = 0$ admits a unique positive bounded solution which is exactly K_1 , thanks to the hypothesis that $f_1 > 0$ in $(0, K_1)$ and $f_1 < 0$ in $(K_1, +\infty)$. Therefore, $V_1 \equiv K_1$ in \mathbb{R} . That is, $V_n \rightarrow K_1$ as $n \rightarrow +\infty$. Since the limit does not depend on the particular sequence $(x_n)_{n \in \mathbb{N}}$, it follows that $V(x) \rightarrow K_1$ as $x \rightarrow -\infty$. By the same argument as above and by the assumption that $f_2 > 0$ in $(0, K_2)$ and $f_2 < 0$ in $(K_2, +\infty)$, one can also derive $V(x) \rightarrow K_2$ as $x \rightarrow +\infty$. Thus, (7.25) is achieved. Our claim is thereby proved.

We prove now that V is monotone in \mathbb{R} . Assume not, then there is $x_0 \in \mathbb{R}$ such that $V(x_0)$ reaches a strict local minimum or maximum. Suppose first that $x_0 \in (-\infty, 0)$, one then has $V'(x_0) = 0$ by the regularity of V . On the other hand, by multiplying $d_1 V'' + f_1(V) = 0$ by V' and integrating over $(-\infty, x)$ for any $x \in (-\infty, 0^-]$, one has

$$\frac{d_1}{2} (V'(x))^2 = \int_{V(x)}^{K_1} f_1(s) ds. \tag{7.29}$$

Remember that $f_1 > 0$ in $(0, K_1)$ and $f_1 < 0$ in $(K_1, +\infty)$. Hence, (7.29) yields that $V(x_0) = K_1$. By the Cauchy-Lipschitz theorem, one has $V \equiv K_1$ in $(-\infty, 0)$. This contradicts the assumption that $V(x_0)$ is a strict local minimum or maximum, whence $x_0 \notin (-\infty, 0)$. By analogy to (7.29), multiplying $d_2 V'' + f_2(V) = 0$ by V' and integrating over $(x, +\infty)$ for any

7. Propagation and blocking in a two-patch reaction-diffusion model

$x \in [0^+, +\infty)$ implies

$$\frac{d_2}{2}(V'(x))^2 = \int_{V(x)}^{K_2} f_2(s)ds. \quad (7.30)$$

One can use the same procedure to exclude the case that $x_0 \in (0, +\infty)$, by noticing that $f_2 > 0$ in $(0, K_2)$ and $f_2 < 0$ in $(K_2, +\infty)$. Consequently, V is monotone in $(-\infty, 0)$ and in $(0, +\infty)$, respectively. Together with the interface condition $V'(0^-) = \sigma V'(0^+)$ and $\sigma > 0$, one then deduces that V is monotone in \mathbb{R} . In particular, if $K_1 = K_2$, then $V \equiv K_1$ in \mathbb{R} .

Consider now $K_1 < K_2$. We show that $V' > 0$ in $(-\infty, 0^-] \cup [0^+, +\infty)$. Assume not. Suppose first that there is $x_0 \in (-\infty, 0^-]$ such that $V'(x_0) = 0$, then the Cauchy-Lipschitz theorem gives that $V \equiv K_1$ in $(-\infty, 0]$, whence $V(0) = K_1$ and $V'(0) = 0$. Then using (7.30) with $x = 0^+$, one finally derives $V \equiv K_2$ in $[0, +\infty)$. Thus, $V(0) = K_2$, which is a contradiction. Therefore, $V' > 0$ in $(-\infty, 0^-]$. Similarly, one can also show that $V' > 0$ in $[0^+, +\infty)$. Consequently, $V' > 0$ in $(-\infty, 0^-] \cup [0^+, +\infty)$ and therefore $K_1 < V(\cdot) < K_2$ in \mathbb{R} . Moreover, by (7.29)–(7.30) and by the interface condition $V'(0^-) = \sigma V'(0^+)$, one has

$$\int_{V(0)}^{K_1} f_1(s)ds = \frac{d_1\sigma^2}{d_2} \int_{V(0)}^{K_2} f_2(s)ds.$$

Notice that the function $\nu \mapsto \int_{\nu}^{K_1} f_1(s)ds$ is continuous increasing in $[K_1, K_2]$ and vanishes at K_1 , while the function $\nu \mapsto \frac{d_1\sigma^2}{d_2} \int_{\nu}^{K_2} f_2(s)ds$ is continuous decreasing in $[K_1, K_2]$ and vanishes at K_2 . Therefore, there exists a unique $\nu_0 \in (K_1, K_2)$ such that

$$\int_{\nu_0}^{K_1} f_1(s)ds = \frac{d_1\sigma^2}{d_2} \int_{\nu_0}^{K_2} f_2(s)ds,$$

and necessarily $V(0) = \nu_0$. Hence, $V(0)$ is unique and then $V'(0^-)$ and $V'(0^+)$ are uniquely determined by

$$V'(0^-) = \sqrt{\frac{2}{d_1} \int_{V(0)}^{K_1} f_1(s)ds}, \quad V'(0^+) = \sqrt{\frac{2}{d_2} \int_{V(0)}^{K_2} f_2(s)ds},$$

whence the uniqueness is proved. This completes the proof of Proposition 7.5. \square

Proof of Proposition 7.6. Let u be the solution to (7.3) with a nonnegative, bounded and continuous initial datum $u_0 \not\equiv 0$. The comparison principle Proposition 7.4 gives that $0 < u(t, x) < M := \max(K_2, \|u_0\|_{L^\infty(\mathbb{R})})$ for all $(t, x) \in (0, +\infty) \times \mathbb{R}$.

Choose $R > 0$ and w as in (7.26) and (7.27), then there is $\varepsilon > 0$ so small that εw satisfies $-d_2\varepsilon w'' < f_2(\varepsilon w)$ in $(-R, R)$ and $\varepsilon w(\cdot - R - 1) < u(1, \cdot)$ in \mathbb{R} . Let \underline{u} and \bar{u} be, respectively, the solutions to (7.3) with initial conditions $\varepsilon w(\cdot - R - 1)$ and M , then it follows from Proposition 7.4 that \underline{u} is increasing in t , whereas \bar{u} is nonincreasing in t . Since $0 < \underline{u}(t, x) < \bar{u}(t, x) \leq M$

for all $(t, x) \in (0, +\infty) \times \mathbb{R}$, it follows from parabolic estimates that $u(t, \cdot)$ and $\bar{u}(t, \cdot)$ converge as $t \rightarrow +\infty$, locally uniformly in \mathbb{R} , to positive bounded stationary solutions p and q of (7.3), respectively. Moreover,

$$0 < p = \lim_{t \rightarrow +\infty} \underline{u}(t, \cdot) \leq \liminf_{t \rightarrow +\infty} u(t, \cdot) \leq \limsup_{t \rightarrow +\infty} u(t, \cdot) \leq \lim_{t \rightarrow +\infty} \bar{u}(t, \cdot) = q \leq M,$$

locally uniformly in \mathbb{R} . Due to the uniqueness of the positive bounded classical stationary solution to problem (7.3), one has $p = q = V$ in \mathbb{R} . The conclusion is thereby proved. \square

Proof of Theorem 7.7. Assume that u is the solution of (7.3) with a nonnegative continuous and compactly supported initial datum $u_0 \not\equiv 0$. By comparison principle, one has $u(t, x) > 0$ for all $t > 0$ and $x \in \mathbb{R}$. Moreover, Proposition 7.6 implies that

$$u(t, x) \rightarrow V(x) \text{ as } t \rightarrow +\infty, \text{ locally uniformly in } x \in \mathbb{R}, \quad (7.31)$$

where V is the unique positive bounded and classical stationary solution to (7.3) obtained in Proposition 7.5. Since $V(-\infty) = K_1$, $V(+\infty) = K_2$ and $K_1 \leq V(x) \leq K_2$ for $x \in \mathbb{R}$, it follows that, for any $\delta > 0$ small, there exist $x_1 < 0$ negative enough and $x_2 > 0$ positive enough such that

$$K_1 \leq V(x) \leq K_1 + \delta/2 \text{ for } x \leq x_1, \quad K_2 - \delta/2 \leq V(x) \leq K_2 \text{ for } x \geq x_2. \quad (7.32)$$

By (7.31), one can pick $t_0 > 0$ sufficiently large so that for all $t \geq t_0$,

$$|u(t, x) - V(x)| \leq \delta/2, \text{ uniformly in } x \in [x_1, x_2]. \quad (7.33)$$

Thanks to (7.32) and (7.33), it is easily seen that, for all $t \geq t_0$,

$$K_1 - \delta/2 \leq u(t, x_1) \leq K_1 + \delta, \quad (7.34)$$

$$K_2 - \delta \leq u(t, x_2) \leq K_2 + \delta/2. \quad (7.35)$$

We first look at the spreading of u in the negative direction. Let $w_0 \not\equiv 0$ be a nonnegative, bounded, continuous and compactly supported function in \mathbb{R} such that $\text{spt}(w_0) \subset [x_1 - 2, x_1 - 1]$ and such that w_0 is strictly below $u(t_0, \cdot)$ satisfying $0 \leq w_0 < \min(\|u_0\|_{L^\infty(\mathbb{R})}, K_1 - 2\delta)$ in \mathbb{R} . Consider the Cauchy problem

$$\begin{cases} w_t = d_1 w_{xx} + g_1(w), & t > 0, \ x \in \mathbb{R}, \\ w(0, \cdot) = w_0, & x \in \mathbb{R}, \end{cases} \quad (7.36)$$

where g_1 is of class $C^1(\overline{\mathbb{R}}_+)$ and satisfies the KPP assumption, that is, $g_1(0) = g_1(K_1 - 2\delta) = 0$,

7. Propagation and blocking in a two-patch reaction-diffusion model

$0 < g_1(s) \leq g_1'(0)s$ for all $s \in (0, K_1 - 2\delta)$, $g_1'(K_1 - 2\delta) < 0$, and $g_1 < 0$ in $(K_1 - 2\delta, +\infty)$. Moreover, we assume that $g_1'(0) = f_1'(0)$ and $g_1 \leq f_1$ on $(0, K_1 - 2\delta)$. From the maximum principle, it immediately follows that $0 < w(t, x) < K_1 - 2\delta$ for all $t > 0$, $x \in \mathbb{R}$. This implies that $w(t - t_0, x_1) < K_1 - 2\delta < u(t, x_1)$ for all $t \geq t_0$, thanks to (7.34). Notice also that $w_0(x) < u(t_0, x)$ for $x \in (-\infty, x_1]$. By the comparison principle, it turns out that $w(t - t_0, x) < u(t, x)$ for all $t > t_0$ and $x \leq x_1$. Furthermore, it is known that the solution w of (7.36) admits an asymptotic spreading speed $c_1^* = 2\sqrt{d_1 f_1'(0)}$ (see [9]) such that

$$\text{for all } 0 < \varepsilon < c_1^*, \quad \inf_{|x| \leq (c_1^* - \varepsilon)t} w(t, x) \rightarrow K_1 - 2\delta \quad \text{as } t \rightarrow +\infty.$$

By virtue of (7.32), we then obtain that, for $t > t_0$ and $x \leq x_1$,

$$\text{for all } 0 < \varepsilon < c_1^*, \quad V(x) - 4\delta < K_1 - 3\delta \leq \inf_{(-c_1^* + \frac{\varepsilon}{2})(t-t_0) \leq x \leq x_1} w(t - t_0, x) \leq \inf_{(-c_1^* + \varepsilon)t \leq x \leq x_1} u(t, x). \quad (7.37)$$

Next, take $M_1 := \max(\|u_0\|_{L^\infty(\mathbb{R})}, K_1 + \delta, K_2)$. Let \tilde{g}_1 be of class C^1 in $\overline{\mathbb{R}_+}$ such that $\tilde{g}_1(0) = \tilde{g}_1(K_1 + \delta) = 0$, $\tilde{g}_1 > 0$ in $(0, K_1 + \delta)$, $\tilde{g}_1'(0) > 0$, $\tilde{g}_1'(K_1 + \delta) < 0$, and $\tilde{g} < 0$ in $(K_1 + \delta, +\infty)$. We further assume that $f_1 \leq \tilde{g}_1$ for $s \in [0, K_1]$. Then, the solution to the ODE $\xi'(t) = \tilde{g}_1(\xi(t))$ for $t > t_0$ with $\xi(t_0) = M_1$ is nonincreasing for $t \geq t_0$ and satisfies $\xi(t) \rightarrow K_1 + \delta$ as $t \rightarrow +\infty$. Since $0 < u(t, x) \leq M_1$ for all $(t, x) \in \mathbb{R}_+ \times \mathbb{R}$ thanks to Proposition 7.4, it follows that $u(t_0, x) \leq \xi(t_0)$ for all $x \leq x_1$. Moreover, $u(t, x_1) \leq K_1 + \delta \leq \xi(t)$ for all $t \geq t_0$ by (7.34). Applying a comparison argument yields that $u(t, x) \leq \xi(t)$ for all $t \geq t_0$, $x \leq x_1$. Therefore, we can choose $t_1 > t_0$ such that

$$\sup_{x \leq x_1} u(t_1, x) \leq K_1 + 3\delta/2. \quad (7.38)$$

Let \bar{g}_1 be of class C^1 in $[0, K_1 + 2\delta]$ satisfying the KPP assumption: $\bar{g}_1(0) = \bar{g}_1(K_1 + 2\delta) = 0$, $0 < \bar{g}_1(s) \leq \bar{g}_1'(0)s$ for $s \in (0, K_1 + 2\delta)$. We further assume that $\bar{g}_1'(0) = f_1'(0)$ and $f_1 \leq \bar{g}_1$ for $s \in (0, K_1)$. Then, it is well-known that the KPP equation $u_t = d_1 u_{xx} + \bar{g}_1(u)$ for $(t, x) \in \mathbb{R}_+ \times \mathbb{R}$ admits standard traveling wave solutions of the type $u(t, x) = \bar{\varphi}_c(x \cdot e - ct - h)$ with $e = \pm 1$, $h \in \mathbb{R}$ if and only if $c \geq c_1^* = \sqrt{2d_1 f_1'(0)}$. For any $c \geq c_1^*$, the function $\bar{\varphi}_c$ satisfies

$$d_1 \bar{\varphi}_c'' + c \bar{\varphi}_c' + \bar{g}_1(\bar{\varphi}_c) = 0 \text{ in } \mathbb{R}, \quad \bar{\varphi}_c' < 0 \text{ in } \mathbb{R}, \quad \bar{\varphi}_c(-\infty) = K_1 + 2\delta, \quad \bar{\varphi}_c(+\infty) = 0,$$

and $\bar{\varphi}_c$ is unique up to translations. In particular, for $c = c_1^*$, by choosing $A > 0$ sufficiently large, the function $\bar{\varphi}_{c_1^*}$ satisfies

$$K_1 + 3\delta/2 \leq \bar{\varphi}_{c_1^*}(-x_1 - c_1^*t - A) < K_1 + 2\delta \quad \text{for all } t \geq t_1. \quad (7.39)$$

Due to the exponential decay of $\bar{\varphi}_{c_1^*}(s)$ as $s \rightarrow +\infty$ and the Gaussian upper bound of $u(t_1, x)$ for all $x \leq x_1$ by Lemma 7.36 and due to (7.38)–(7.39), it can be derived that (up to increasing A if needed)

$$u(t_1, x) \leq \bar{\varphi}_{c_1^*}(-x - c_1^*t_1 - A) \text{ for } x \leq x_1.$$

We also notice from (7.34) and (7.39) that $u(t, x_1) \leq K_1 + \delta < \bar{\varphi}_{c_1^*}(-x_1 - c_1^*t - A)$ for all $t \geq t_1$. The comparison principle gives

$$u(t, x) \leq \bar{\varphi}_{c_1^*}(-x - c_1^*t - A) \text{ for all } t \geq t_1 \text{ and } x \leq x_1. \quad (7.40)$$

It then implies that, for $t \geq t_1$ and $x \leq x_1$, it holds

$$\text{for all } 0 < \varepsilon < c_1^*, \quad \sup_{-(c_1^*-\varepsilon)t \leq x \leq x_1} u(t, x) \leq \sup_{-(c_1^*-\varepsilon)t \leq x \leq x_1} \bar{\varphi}_{c_1^*}(-x - c_1^*t - A) \leq K_1 + 2\delta \leq V(x) + 2\delta, \quad (7.41)$$

thanks to (7.32). Combining (7.37) with (7.41), we obtain

$$\text{for all } 0 < \varepsilon < c_1^*, \quad \lim_{t \rightarrow +\infty} \sup_{-(c_1^*-\varepsilon)t \leq x \leq x_1} |u(t, x) - V(x)| = 0, \quad (7.42)$$

that is, u spreads to the left at least with speed c_1^* .

On the other hand, (7.40) also implies that

$$\text{for all } \varepsilon > 0, \quad \lim_{t \rightarrow +\infty} \sup_{x \leq -(c_1^*+\varepsilon)t} u(t, x) \leq \lim_{t \rightarrow +\infty} \sup_{x \leq -(c_1^*+\varepsilon)t} \bar{\varphi}_{c_1^*}(-x - c_1^*t - A) = 0,$$

which indicates that u spreads to the left at most with speed c_1^* . Therefore, the leftward spreading result of u is proved.

By a slight modification of the above argument, one can also show that u spreads to the right with speed c_2^* . Together with (7.33), the proof of this theorem is complete. \square

7.4 The KPP-bistable case

In this section, we will consider (7.3) with KPP-bistable reactions. We assume that patch 1 is of KPP type, whereas patch 2 is of bistable type. We will consider the sign of the mass $\int_0^{K_2} f_2(s)ds$ and the relation between K_1 and θ or K_2 (or possibly θ^* where $\theta^* \in (\theta, K_2)$ is such that $\int_0^{\theta^*} f_2(s)ds = 0$ provided $\int_0^{K_2} f_2(s)ds > 0$) in complete generality.

7.4.1 Semi-persistence result: proof of Theorem 7.8

To begin with, we shall prove the semi-persistence result and the leftward spreading result in patch 1, thanks to the KPP assumption on f_1 . The technique here is similar to that of Theorem 7.7.

Proof of Theorem 7.8. Let u be the solution to (7.3) with nonnegative continuous and compactly supported initial datum $u_0 \not\equiv 0$. By Proposition 7.4, we have $0 < u(t, x) < M := \max(K_1, K_2, \|u_0\|_{L^\infty(\mathbb{R})})$ for all $t > 0, x \in \mathbb{R}$.

Take $R > 0$ large enough such that

$$\frac{\pi}{2R} < \sqrt{\frac{f_1'(0)}{2d_1}}. \quad (7.43)$$

Set

$$\psi(x) = \begin{cases} \cos(\frac{\pi}{2R}x) & \text{in } (-R, R), \\ 0, & \text{otherwise.} \end{cases} \quad (7.44)$$

Then there exists $\varepsilon_0 > 0$ such that the function $\varepsilon\psi$ satisfies $-d_1(\varepsilon\psi)'' \leq f_1(\varepsilon\psi)$ in \mathbb{R} for all $0 < \varepsilon \leq \varepsilon_0$. Choose now $x_0 \leq -R$ and pick $\varepsilon \in (0, \varepsilon_0]$ such that $\varepsilon\psi(\cdot - x_0) < u(1, \cdot)$ in \mathbb{R} . Let v and w be solutions to (7.3) with initial functions $v_0 = \varepsilon\psi(\cdot - x_0)$ in \mathbb{R} and $w_0 \equiv \max(K_1, K_2, \|u_0\|_{L^\infty(\mathbb{R})})$ in \mathbb{R} , respectively. Then by Proposition 7.4, v is increasing in t and w is nonincreasing in t , moreover, $0 < v(t, x) < u(t+1, x) < w(t+1, x) \leq M$ for all $t > 0, x \in \mathbb{R}$. By standard parabolic estimates, it follows that $v(t, \cdot)$ and $w(t, \cdot)$ converge as $t \rightarrow +\infty$, locally uniformly in \mathbb{R} , to positive bounded stationary solutions p and q of (7.3), respectively. Furthermore, there holds

$$0 < p \leq \liminf_{t \rightarrow +\infty} u(t, \cdot) \leq \limsup_{t \rightarrow +\infty} u(t, \cdot) \leq q \leq M, \text{ locally uniformly in } \mathbb{R}. \quad (7.45)$$

Notice also that $p > v_0$ in \mathbb{R} . We observe from the continuity of $p - v_0$ that there is $\widehat{\kappa} > 1$ such that $p > \varepsilon\psi(\cdot - \kappa x_0)$ in $[\kappa x_0 - R, \kappa x_0 + R]$ for all $\kappa \in [1, \widehat{\kappa}]$ and for any $x_0 \leq -R$. Define

$$\kappa^* := \sup \{ \kappa \geq 1 : p > \varepsilon\psi(\cdot - \tilde{\kappa}x_0) \text{ in } [\tilde{\kappa}x_0 - R, \tilde{\kappa}x_0 + R] \text{ for all } \tilde{\kappa} \in [1, \kappa] \}.$$

It follows that $\kappa^* \geq \widehat{\kappa} > 1$. We are going to prove that $\kappa^* = +\infty$. Assume, towards contradiction, that $\kappa^* < +\infty$, we see from the definition of κ^* that $p \geq \varepsilon\psi(\cdot - \kappa^*x_0)$ in $[\kappa^*x_0 - R, \kappa^*x_0 + R]$ and there is $x^* \in [\kappa^*x_0 - R, \kappa^*x_0 + R]$ such that $p(x^*) = \varepsilon\psi(x^* - \kappa^*x_0)$. Since $p > 0$ in \mathbb{R} and $\psi(\cdot - \kappa^*x_0) = 0$ at $x = \kappa^*x_0 \pm R$, one has $x^* \in (\kappa^*x_0 - R, \kappa^*x_0 + R)$. Then the strong maximum principle implies that $p \equiv \varepsilon\psi(\cdot - \kappa^*x_0)$ in $[\kappa^*x_0 - R, \kappa^*x_0 + R]$. This is impossible. Thus, $\kappa^* = +\infty$ and $p > \varepsilon\psi(\cdot - \kappa x_0)$ in $[\kappa x_0 - R, \kappa x_0 + R]$ for all $\kappa \geq 1$ and $x_0 \leq -R$. This implies, in particular, that $p(x) > \varepsilon\psi(0) = \varepsilon$ for all $x \leq x_0 (\leq -R)$.

Thus,

$$\liminf_{t \rightarrow +\infty} u(t, x) \geq p(x) > \varepsilon, \text{ uniformly in } x \leq x_0 (\leq -R). \quad (7.46)$$

On the other hand, since $p > 0$ in \mathbb{R} , then, for any given $\bar{x} > x_0$, there holds $\min_{[x_0, \bar{x}]} p > 0$, whence it follows from (7.45) that

$$\liminf_{t \rightarrow +\infty} u(t, x) \geq \min_{[x_0, \bar{x}]} p > 0, \text{ uniformly in } x \in [x_0, \bar{x}]. \quad (7.47)$$

Combining (7.46) with (7.47), one reaches the semi-persistence result, that is, for any $\bar{x} \in \mathbb{R}$,

$$\liminf_{t \rightarrow +\infty} u(t, x) > 0, \text{ uniformly in } x \leq \bar{x}.$$

In what follows, we turn to the proof of the leftward spreading result. Consider any sequence $(x_n)_{n \in \mathbb{N}}$ such that $x_n \rightarrow -\infty$ as $n \rightarrow +\infty$. From standard elliptic estimates, up to a subsequence, the functions $p_n := p(\cdot + x_n)$ converge as $n \rightarrow +\infty$ in $C_{loc}^2(\mathbb{R})$ to a classical bounded solution p_∞ of $d_1 p_\infty'' + f_1(p_\infty) = 0$ in \mathbb{R} with $p_\infty > \varepsilon$ in \mathbb{R} . The comparison principle implies that $p_\infty(x) \geq \vartheta(t)$ for all $t \geq 0$ and $x \in \mathbb{R}$, where $\vartheta(t)$ solves $\vartheta'(t) = f_1(\vartheta(t))$ for all $t > 0$ and $\vartheta(0) = \varepsilon$. Since $f_1 > 0$ in $(0, K_1)$ and $f_1(K_1) = 0$, one has $\vartheta(t) \nearrow K_1$ as $t \rightarrow +\infty$. Thus, $p_\infty \geq K_1$ in \mathbb{R} . Similarly, the functions $q_n := q(\cdot + x_n)$ converge as $n \rightarrow +\infty$ in $C_{loc}^2(\mathbb{R})$ to a classical bounded solution q_∞ of $d_1 q_\infty'' + f_1(q_\infty) = 0$ in \mathbb{R} with $p_\infty \leq q_\infty \leq M$ in \mathbb{R} . Moreover, the comparison principle yields that $q_\infty(x) \leq \beta(t)$ for all $t \geq 0$ and $x \in \mathbb{R}$, where $\beta(t)$ solves $\beta'(t) = f_1(\beta(t))$ for $t > 0$ and $\beta(0) = M$. Since $f_1 < 0$ in $(K_1, +\infty)$ and $f_1(K_1) = 0$, one has $\beta(t) \searrow K_1$ as $t \rightarrow +\infty$, whence $q_\infty \leq K_1$. Consequently, $p_\infty \equiv K_1 \equiv q_\infty$ in \mathbb{R} . Thus, for any $\delta > 0$, there exist $t_1 > 0$ and $x_1 < 0$ such that

$$K_1 - \delta \leq u(t, x_1) \leq K_1 + \delta \text{ for all } t \geq t_1. \quad (7.48)$$

The rest of the proof is similar to that of Theorem 7.7. We sketch the details for the sake of completeness. Let $z_0 \not\equiv 0$ be a nonnegative continuous and compactly supported function in \mathbb{R} such that $\text{spt}(z_0) \subset [x_1 - 2, x_1 - 1]$ and such that z_0 is strictly below $u(t_1, \cdot)$ with $0 \leq z_0 < \min(\|u_0\|_{L^\infty(\mathbb{R})}, K_1 - \delta)$ in \mathbb{R} . Consider the Cauchy problem

$$\begin{cases} z_t = d_1 z_{xx} + g_1(z), & t > 0, x \in \mathbb{R}, \\ z(0, \cdot) = z_0, \end{cases} \quad (7.49)$$

where g_1 is of class $C^1(\overline{\mathbb{R}}_+)$ satisfying the KPP hypothesis: $g_1(0) = g_1(K_1 - \delta) = 0$, $0 < g_1(s) \leq g_1'(0)s$ in $(0, K_1 - \delta)$, $g_1'(K_1 - \delta) < 0$ and $g_1 < 0$ in $(K_1 - \delta, +\infty)$. We further assume that $g_1'(0) = f_1'(0)$ and $g_1 \leq f_1$ on $(0, K_1 - \delta)$. From the maximum principle, it immediately follows that $0 < z(t, x) < K_1 - \delta$ for all $t > 0$, $x \in \mathbb{R}$. This implies that $z(t - t_1, x_1) < K_1 - \delta \leq u(t, x_1)$ for all $t \geq t_1$, thanks to (7.48). Notice also that $z_0(x) < u(t_1, x)$

7. Propagation and blocking in a two-patch reaction-diffusion model

for $x \leq x_1$. By a comparison argument, it turns out that $z(t - t_1, x) < u(t, x)$ for all $t \geq t_1$ and $x \leq x_1$. In the spirit of [9], we know that the solution z of (7.49) admits an asymptotic spreading speed $c_1^* = 2\sqrt{d_1 f_1'(0)}$ such that

$$\text{for all } 0 < \varepsilon < c_1^*, \quad \inf_{|x| \leq (c_1^* - \varepsilon)t} z(t, x) \rightarrow K_1 - \delta \text{ as } t \rightarrow +\infty.$$

One then obtains that, for all $t > t_1$,

$$\text{for all } 0 < \varepsilon < c_1^*, \quad K_1 - 2\delta \leq \inf_{-(c_1^* - \frac{\varepsilon}{2})(t - t_1) \leq x \leq x_1} z(t - t_1, x) \leq \inf_{-(c_1^* - \varepsilon)t \leq x \leq x_1} u(t, x). \quad (7.50)$$

Take $M_1 := \max(\|u_0\|_{L^\infty(\mathbb{R})}, K_1 + \delta, K_2)$. Let $\tilde{g}_1(s)$ be of class C^1 in $\overline{\mathbb{R}}_+$ such that $\tilde{g}_1(0) = \tilde{g}_1(K_1 + \delta) = 0$, $\tilde{g}_1 > 0$ in $(0, K_1 + \delta)$, $\tilde{g}_1'(0) > 0$, $\tilde{g}_1'(K_1 + \delta) < 0$ and $\tilde{g}_1 < 0$ in $(K_1 + \delta, +\infty)$. Moreover, $f_1 \leq \tilde{g}_1$ in $[0, K_1]$. Then the solution to the ODE $\xi'(t) = \tilde{g}_1(\xi(t))$ for $t > t_1$ with $\xi(t_1) = M_1$ is nonincreasing for $t \geq t_1$ and satisfies $\xi(t) \rightarrow K_1 + \delta$ as $t \rightarrow +\infty$. Since $0 < u(t, x) \leq M_1$ for all $t > 0, x \in \mathbb{R}$, we have $u(t_1, x) \leq \xi(t_1)$ for all $x \leq x_1$. By (7.48), one also has $u(t, x_1) \leq K_1 + \delta \leq \xi(t)$ for all $t \geq t_1$. The comparison principle gives that $u(t, x) \leq \xi(t)$ for all $t \geq t_1, x \leq x_1$. Therefore, one can choose $t_2 > t_1$ such that

$$\sup_{x \leq x_1} u(t_2, x) \leq \xi(t_2) \leq K_1 + 3\delta/2. \quad (7.51)$$

Next, define $\bar{g}_1 \in C^1([0, K_1 + 2\delta])$ being of KPP type, namely, $\bar{g}_1(0) = \bar{g}_1(K_1 + 2\delta) = 0$, $0 < g_1(s) \leq \bar{g}_1'(0)s$ for $s \in (0, K + 2\delta)$ and $\bar{g}_1'(K_1 + 2\delta) < 0$. We further assume that $\bar{g}_1'(0) = f_1'(0)$ and $f_1 \leq \bar{g}_1$ in $(0, K_1)$. Then, it is well-known that the KPP equation $u_t = d_1 u_{xx} + \bar{g}_1(u)$ for $(t, x) \in \mathbb{R}_+ \times \mathbb{R}$ admits traveling wave solutions of the type $u(t, x) = \bar{\varphi}_c(x \cdot e - ct - h)$ with $e = \pm 1, h \in \mathbb{R}$ if and only if $c \geq c_1^* = \sqrt{2d_1 f_1'(0)}$. For any $c \geq c_1^*$, the function $\bar{\varphi}_c$ satisfies

$$d_1 \bar{\varphi}_c'' + c \bar{\varphi}_c' + \bar{g}_1(\bar{\varphi}_c) = 0 \text{ in } \mathbb{R}, \quad \bar{\varphi}_c' < 0 \text{ in } \mathbb{R}, \quad \bar{\varphi}_c(-\infty) = K_1 + 2\delta, \quad \bar{\varphi}_c(+\infty) = 0,$$

and $\bar{\varphi}_c$ is unique up to shifts. In particular, for $c = c_1^*$, there is $A > 0$ sufficiently large such that

$$K_1 + 3\delta/2 \leq \bar{\varphi}_{c_1^*}(-x_1 - c_1^*t - A) < K_1 + 2\delta, \quad \text{for all } t \geq t_2. \quad (7.52)$$

From the exponential estimate of $\bar{\varphi}_c(s)$ as $s \rightarrow +\infty$ and from the Gaussian upper bound of $u(t_2, x)$ for $x \leq x_1$ by Lemma 7.36, together with (7.51)–(7.52), it can be deduced that (up to increasing A if needed)

$$u(t_2, x) < \bar{\varphi}_{c_1^*}(-x - c_1^*t_2 - A) \text{ for } x \leq x_1.$$

From (7.48) and (7.52), we have that $u(t, x_1) \leq K_1 + \delta < \bar{\varphi}_{c_1^*}(-x_1 - c_1^*t - A)$ for all $t \geq t_2$.

By a comparison argument, we find that

$$u(t, x) \leq \bar{\varphi}_{c_1^*}(-x - c_1^*t - A) \text{ for } t \geq t_2 \text{ and } x \leq x_1. \quad (7.53)$$

It then implies that, for all $t \geq t_2$,

$$\text{for all } 0 < \varepsilon < c_1^*, \quad \sup_{-(c_1^*-\varepsilon)t \leq x \leq x_1} u(t, x) \leq \sup_{-(c_1^*-\varepsilon)t \leq x \leq x_1} \bar{\varphi}_{c_1^*}(-x - c_1^*t - A) \leq K_1 + 2\delta. \quad (7.54)$$

Owing to (7.50) and (7.54), we have

$$\text{for all } 0 < \varepsilon < c_1^*, \quad K_1 - 2\delta \leq \inf_{-(c_1^*-\varepsilon)t \leq x \leq x_1} u(t, x) \leq \sup_{-(c_1^*-\varepsilon)t \leq x \leq x_1} u(t, x) \leq K_1 + 2\delta,$$

which implies that

$$\forall \varepsilon \in (0, c_1^*), \quad \forall \delta > 0, \quad \exists x_1 \in \mathbb{R}, \quad \limsup_{t \rightarrow +\infty} \left(\sup_{-(c_1^*-\varepsilon)t \leq x \leq x_1} |u(t, x) - K_1| \right) \leq 2\delta,$$

namely, u spreads to the left at least with speed c_1^* .

Moreover, we can also deduce from (7.53) that

$$\text{for all } \varepsilon > 0, \quad \sup_{x \leq -(c_1^*+\varepsilon)t} u(t, x) \leq \sup_{x \leq -(c_1^*+\varepsilon)t} \bar{\varphi}_{c_1^*}(-x - c_1^*t - A).$$

It follows that

$$\text{for all } \varepsilon > 0, \quad \lim_{t \rightarrow +\infty} \left(\sup_{x \leq -(c_1^*+\varepsilon)t} u(t, x) \right) = 0$$

That is, u spreads at most with speed c_1^* in the negative direction. This finishes the proof. \square

7.4.2 Preliminaries on the stationary problem: proofs of Propositions 7.10–7.12

This section is devoted to the study of the stationary problem associated with (7.3), and we give the proofs of Propositions 7.10–7.12.

Proof of Proposition 7.10. Suppose that U is a nonnegative nontrivial classical stationary solution of (7.3). The strong maximum principle and the Hopf lemma then imply that $U > 0$ in \mathbb{R} . Following the same lines as the proof of Proposition 7.5, we see that $U(-\infty) = K_1$ and U is monotone for $x \leq 0$. That is, if $U(0) < K_1$, then $U' < 0$ in $(-\infty, 0^-]$. If $U(0) > K_1$, then $U' > 0$ in $(-\infty, 0^-]$. If $U(0) = K_1$, then $U \equiv K_1$ in $(-\infty, 0]$.

Suppose that $U(+\infty) = 0$. Multiplying $d_2 U'' + f_2(U) = 0$ by U' and integrating the

7. Propagation and blocking in a two-patch reaction-diffusion model

resulting equation over $(x, +\infty)$ for any $x \in [0^+, +\infty)$ yields

$$\frac{d_2}{2}(U'(x))^2 = - \int_0^{U(x)} f_2(s)ds, \quad \forall x \in [0^+, +\infty). \quad (7.55)$$

To discuss the behavior of U in \mathbb{R}_+ , we distinguish three cases with respect to the sign of $\int_0^{K_2} f_2(s)ds$.

Case 1. $\int_0^{K_2} f_2(s)ds < 0$. One then infers from (7.55) that U' has a strict constant sign in $[0^+, +\infty)$, whence $U' < 0$ in $[0^+, +\infty)$ by noticing $U(0) > 0$ and $U(+\infty) = 0$. This implies that $U'(0^-) < 0$ and $U(0) < K_1$ by using the interface condition in (7.3). Therefore, the stationary solution U of (7.3) such that $U(-\infty) = K_1$ and $U(+\infty) = 0$ satisfies $U' < 0$ in $(-\infty, 0^-] \cup [0^+, +\infty)$ and $U(0) < K_1$.

Case 2. $\int_0^{K_2} f_2(s)ds = 0$. Suppose that there is a point $x_0 \in [0, +\infty)$ such that $U(x_0) = K_2$. By (7.55), one deduces that $U'(x_0) = 0$. The Cauchy-Lipschitz theorem then implies that the problem $d_2 U''(x) + f_2(U(x)) = 0$ in $(0, +\infty)$ with $U(x_0) = K_2$ and $U'(x_0) = 0$ has a unique solution $U \equiv K_2$ in $[0, +\infty)$. This contradicts $U(+\infty) = 0$. Thus, $0 < U(\cdot) < K_2$ in $[0, +\infty)$ and therefore U' has a strict constant sign in $[0^+, +\infty)$ by (7.55). Hence, $U' < 0$ in $[0^+, +\infty)$ due to $U(0) > 0$ and $U(+\infty) = 0$. Therefore, $U'(0^-) < 0$ and $U(0) < K_1$. Consequently, the stationary solution U of (7.3) such that $U(-\infty) = K_1$ and $U(+\infty) = 0$ satisfies $U' < 0$ in $(-\infty, 0^-] \cup [0^+, +\infty)$ and $U(0) < \min(K_1, K_2)$ (see Fig. 20).

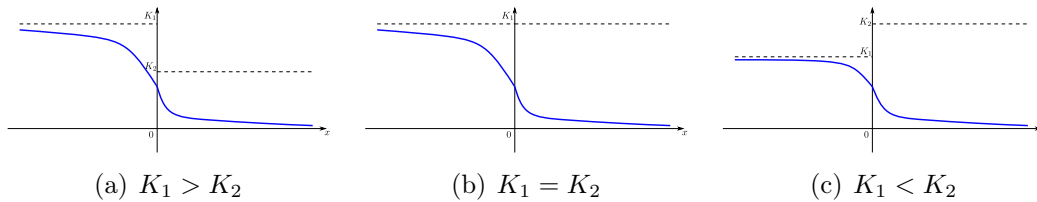

Figure 20: $\int_0^{K_2} f_2(s)ds = 0$.

Case 3. $\int_0^{K_2} f_2(s)ds > 0$. Let $\theta^* \in (\theta, K_2)$ be such that $\int_0^{\theta^*} f_2(s)ds = 0$. We first observe from (7.55) that $U \notin (\theta^*, Q)$ in $[0, +\infty)$, where $Q > K_2$ is such that $\int_0^Q f_2(s)ds = 0$ due to $f_2 < 0$ in $(K_2, +\infty)$. By continuity of U and $U(+\infty) = 0$, one then derives that $0 < U(\cdot) \leq \theta^*$ in $[0, +\infty)$. Suppose that there is $x \in [0, +\infty)$ such that $U'(x) = 0$. Take $x_0 := \max\{x \geq 0 : U'(x) = 0\}$. From (7.55) and the fact that $0 < U(\cdot) \leq \theta^*$ in $[0, +\infty)$, it follows that $U(x_0) = \theta^*$. Moreover, $d_2 U''(x_0) = -f_2(U(x_0)) < 0$ implies that $U(x_0)$ is a strict local maximum in \mathbb{R}_+ . Thus, by the definition of x_0 , one has $U' < 0$ in $(x_0, +\infty)$. Indeed, the shape of U in $(x_0, +\infty)$ is bump-like and $U' < 0$ in $(x_0, +\infty)$ thanks to the uniqueness of the Cauchy problem, since it is known that the bistable equation $d_2 u'' + f_2(u) = 0$ in \mathbb{R}

admits an even bump-like solution $u(\cdot - \bar{x})$ for any $\bar{x} \in \mathbb{R}$, satisfying

$$u(0) = \theta^*, \quad u'(0) = 0, \quad u' < 0 \text{ in } (0, +\infty), \quad u(\pm\infty) = 0.$$

If $x_0 > 0$, it then follows that $U' > 0$ in $(x_0 - \delta, x_0) \subset \mathbb{R}_+$ for some $\delta > 0$ very small. We then claim that $U' > 0$ in $[0^+, x_0)$. Assume not, then there exists a point $x_* \in [0^+, x_0)$ such that $U'(x_*) = 0$ and $U(x_*) \in (0, \theta^*)$ is a local minimum, which contradicts (7.55) with $x = x_*$. This proves our claim. Thus, $U' > 0$ in $[0^+, x_0)$, $U'(x_0) = 0$, $U(x_0) = \theta^*$ and $U'(x) < 0$ in $(x_0, +\infty)$, which implies that $U' > 0$ in $(-\infty, 0^-]$ by the interface condition in (7.3) and by the monotonicity of U in $(-\infty, 0^-]$, and then $K_1 < U(0) < \theta^*$ (see the black curve in Fig. 21 (a)). If $x_0 = 0$, then $U'(0) = 0$, $U(0) = \theta^*$ and $U' < 0$ in $(0, +\infty)$, which also implies $U \equiv K_1 = \theta^*$ in \mathbb{R}_- (see the black curve in Fig. 21 (b)). Consequently, under the assumption that there is $x_0 \geq 0$ such that $U'(x_0) = 0$, the stationary solution U of (7.3) such that $U(-\infty) = K_1$, $U(+\infty) = 0$ is bump-like, moreover, such x_0 is unique and is such that $U(x_0) = \theta^* = \max_{\mathbb{R}} U$, provided that $K_1 \leq \theta^*$.

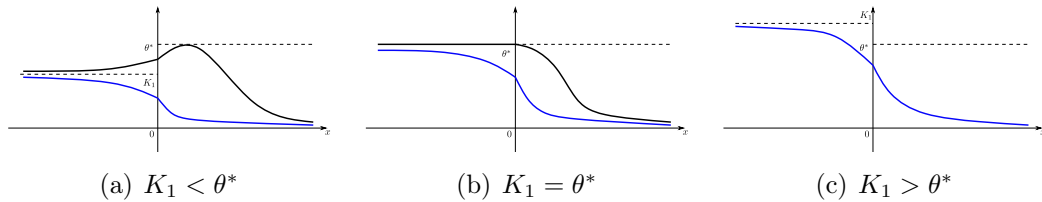

Figure 21: $\int_0^{K_2} f_2(s)ds > 0$.

Now suppose that U' has a strict constant sign in $[0^+, +\infty)$, which implies necessarily $U' < 0$ in $[0^+, +\infty)$ due to $U(0) > 0$ and $U(+\infty) = 0$. Then, $U' < 0$ in $(-\infty, 0^-]$ by applying the interface condition in (7.3) and by the monotonicity of U for $x \leq 0$. Thus, $U(0) < K_1$. Moreover, one infers from (7.55) and $0 < U(\cdot) \leq \theta^*$ in $[0, +\infty)$ that $U(0) < \theta^*$. Consequently, in this case, the stationary solution U of (7.3) such that $U(-\infty) = K_1$ and $U(+\infty) = 0$ satisfies $U' < 0$ in $(-\infty, 0^-] \cup [0^+, +\infty)$ and $U(0) < \min(K_1, \theta^*)$ (see the blue curves in Fig. 21). The proof of Proposition 7.10 is complete. \square

Proof of Proposition 7.11. Suppose that U is a nonnegative nontrivial bounded and classical stationary solution of (7.3). The strong maximum principle and the Hopf lemma implies that $U > 0$ in \mathbb{R} .

We claim that the existence of the nonnegative bounded and classical stationary solution U of (7.3) such that $U(-\infty) = K_1$ and $U(+\infty) = 0$ is equivalent to the existence of $\xi > 0$ such that

$$\int_0^\xi f_2(s)ds \leq 0, \quad \frac{1}{d_1} \int_\xi^{K_1} f_1(s)ds = -\frac{\sigma^2}{d_2} \int_0^\xi f_2(s)ds, \quad (7.56)$$

7. Propagation and blocking in a two-patch reaction-diffusion model

and

$$\begin{cases} \xi < K_1, & \text{if } \int_0^{K_2} f_2(s)ds < 0, \\ \xi < \min(K_1, K_2), & \text{if } \int_0^{K_2} f_2(s)ds = 0, \\ \xi \leq \theta^*, & \text{if } \int_0^{K_2} f_2(s)ds > 0, \end{cases} \quad (7.57)$$

hold true, where $\theta^* \in (\theta, K_2)$ is such that $\int_0^{\theta^*} f_2(s)ds = 0$. Then, under the assumptions of Proposition 7.11, such a $\xi > 0$ satisfying (7.56)–(7.57) indeed exists by qualitative comparison of the graphs of the integrals in (7.56). Specifically, (i) in the case of $\int_0^{K_2} f_2(s)ds < 0$, since the function $\nu \mapsto \frac{1}{d_1} \int_\nu^{K_1} f_1(s)ds$ is continuous decreasing in $(0, K_1)$ and vanishes at K_1 , whereas the function $\nu \mapsto -\frac{\sigma^2}{d_2} \int_0^\nu f_2(s)ds$ is continuous and positive in $(0, K_1]$ and vanishes at 0, it follows that there is $\xi \in (0, K_1)$ such that (7.56) holds; (ii) in the case of $\int_0^{K_2} f_2(s)ds = 0$ and $K_1 < K_2$, since the function $\nu \mapsto \frac{1}{d_1} \int_\nu^{K_1} f_1(s)ds$ is continuous decreasing in $(0, K_1)$ and vanishes at K_1 , whereas the function $\nu \mapsto -\frac{\sigma^2}{d_2} \int_0^\nu f_2(s)ds$ is continuous and positive in $(0, K_2) \supseteq (0, K_1]$ and vanishes at 0, then there is $\xi \in (0, K_1)$ such that (7.56) holds true; (iii) as for the case of $\int_0^{K_2} f_2(s)ds > 0$ and $K_1 \leq \theta^*$, let us first assume that $K_1 < \theta^*$. Since the function $\nu \mapsto \frac{1}{d_1} \int_\nu^{K_1} f_1(s)ds$ is continuous decreasing in $(0, K_1)$ and vanishes at K_1 , while the function $\nu \mapsto -\frac{\sigma^2}{d_2} \int_0^\nu f_2(s)ds$ is continuous and positive in $(0, \theta^*) \supseteq (0, K_1]$ and vanishes at 0, there exists $\xi \in (0, K_1)$ such that (7.56) holds. Suppose now that $K_1 = \theta^*$, it is easy to check that $\xi = K_1 = \theta^*$ satisfies (7.56). The conclusion of this proposition is therefore achieved. Now, it is left to prove our claim, for which we divide into two steps.

Step 1. Suppose that U is a nonnegative, bounded and classical stationary solution of (7.3) such that $U(-\infty) = K_1$ and $U(+\infty) = 0$, then the quantity $\xi := U(0) > 0$ necessarily satisfies (7.57) by Proposition 7.10. It remains to prove (7.56). Multiplying the equation $d_2 U'' + f_2(U) = 0$ by U' and then integrating over $(0^+, +\infty)$ yields that

$$(U'(0^+))^2 = -\frac{2}{d_2} \int_0^{U(0)} f_2(s)ds \geq 0. \quad (7.58)$$

On the other hand, we multiply the equation $d_1 U'' + f_1(U) = 0$ by U' and then integrate over $(-\infty, 0^-)$, then it follows that

$$(U'(0^-))^2 = \frac{2}{d_1} \int_{U(0)}^{K_1} f_1(s)ds.$$

Since $U'(0^-) = \sigma U'(0^+)$, one then derives from above that

$$\frac{1}{d_1} \int_{U(0)}^{K_1} f_1(s)ds = -\frac{\sigma^2}{d_2} \int_0^{U(0)} f_2(s)ds. \quad (7.59)$$

Therefore, (7.56) is achieved by (7.58)–(7.59).

Step 2. Given a $\xi > 0$ satisfying (7.56)–(7.57), we wish to show that (7.3) admits a nonnegative bounded and classical stationary solution U such that $U(-\infty) = K_1$ and $U(+\infty) = 0$.

Set $U(0) = \xi$ and define

$$U'(0^+) = \operatorname{sgn}(U(0) - K_1) \sqrt{-\frac{2}{d_2} \int_0^{U(0)} f_2(s) ds},$$

and

$$U'(0^-) = \operatorname{sgn}(U(0) - K_1) \sqrt{\frac{2}{d_1} \int_{U(0)}^{K_1} f_1(s) ds}.$$

It is obvious to see that $U'(0^-) = \sigma U'(0^+)$, thanks to (7.56).

Step 2.1. Consider now the Cauchy problem in \mathbb{R}_- :

$$\begin{cases} d_1 U'' + f_1(U) = 0, & x \in \mathbb{R}_-, \\ U(0) = \xi > 0, & U'(0^-) = \operatorname{sgn}(U(0) - K_1) \sqrt{\frac{2}{d_1} \int_{U(0)}^{K_1} f_1(s) ds}. \end{cases} \quad (7.60)$$

By the Cauchy-Lipschitz theorem, (7.60) has a unique solution U defined on a maximal interval $(\bar{x}, 0]$ for some $\bar{x} < 0$. Multiplying the equation in (7.60) by U' and then integrating over $(x, 0^-)$ for any $x \in (\bar{x}, 0^-]$ yields that

$$\frac{d_1}{2} ((U'(0^-))^2 - (U'(x))^2) = \int_{U(0)}^{U(x)} f_1(s) ds, \quad \forall x \in (\bar{x}, 0^-].$$

Substituting the formula of $U'(0^-)$ further gives that

$$\frac{d_1}{2} (U'(x))^2 = \int_{U(x)}^{K_1} f_1(s) ds, \quad \forall x \in (\bar{x}, 0^-]. \quad (7.61)$$

We claim that

$$\begin{cases} \text{either } U > K_1, U' > 0 \text{ in } (\bar{x}, 0^-], \\ \text{or } U < K_1, U' < 0 \text{ in } (\bar{x}, 0^-], \\ \text{or } U \equiv K_1 \text{ in } (\bar{x}, 0]. \end{cases}$$

For this purpose, we first prove that either $U(\cdot) - K_1$ has a strict constant sign in $(\bar{x}, 0]$ or $U \equiv K_1$ in $(\bar{x}, 0]$. Indeed, assume that there is $x_0 \in (\bar{x}, 0^-]$ such that $U(x_0) = K_1$, then (7.61) implies $U'(x_0) = 0$. By the uniqueness of the solution to the initial value problem, one has $U \equiv K_1$ in $(\bar{x}, 0]$. Assume now that $U(\cdot) - K_1$ has a strict constant sign in $(\bar{x}, 0]$. Then (7.61) implies that U' has a strict constant sign in $(\bar{x}, 0^-]$. More precisely, one concludes that, if $U(0) > K_1$, then $U > K_1$ and $U' > 0$ in $(\bar{x}, 0^-]$; if $U(0) < K_1$, then $U < K_1$ and $U' < 0$ in $(\bar{x}, 0^-]$. Our claim is achieved.

7. Propagation and blocking in a two-patch reaction-diffusion model

From the above observation, we derive that U is bounded in $(\bar{x}, 0]$: either $K_1 < U(\cdot) < U(0)$ if $U(0) > K_1$, or $U(0) < U(\cdot) < K_1$ if $0 < U(0) < K_1$, or $U \equiv K_1$. Applying a continuation argument, we obtain that the solution U of (7.60) is defined on \mathbb{R}_- , i.e. $\bar{x} = -\infty$.

Now we prove that $U(-\infty) = K_1$. Indeed, let $a := U(-\infty)$, then $K_1 \leq a < U(0)$ if $U(0) > K_1$, or $U(0) < a \leq K_1$ if $0 < U(0) < K_1$. Using (7.61), one has

$$\frac{d_1}{2}(U'(x))^2 \rightarrow \int_a^{K_1} f_1(s)ds \text{ as } x \rightarrow -\infty.$$

This implies that $U(-\infty) = a = K_1$.

Step 2.2. Let U denote the solution of

$$\begin{cases} d_2 U'' + f_2(U) = 0, & x \in \mathbb{R}_+, \\ U(0) = \xi > 0, & U'(0^+) = \operatorname{sgn}(U(0) - K_1) \sqrt{-\frac{2}{d_2} \int_0^{U(0)} f_2(s)ds}. \end{cases} \quad (7.62)$$

The solution of (7.62) exists and is unique on a maximal interval $(0, \bar{x})$ for some $\bar{x} > 0$. Multiplying the equation in (7.62) by U' and integrating over $(0^+, x)$ for any $x \in [0^+, \bar{x})$ yields that

$$\frac{d_2}{2}((U'(x))^2 - (U'(0^+))^2) = \int_{U(x)}^{U(0)} f_2(s)ds, \quad \forall x \in [0^+, \bar{x}),$$

whence by using the expression of $U'(0^+)$, one has

$$\frac{d_2}{2}(U'(x))^2 = - \int_0^{U(x)} f_2(s)ds, \quad \forall x \in [0^+, \bar{x}). \quad (7.63)$$

We observe that $U > 0$ in $[0, \bar{x})$. Indeed, assume towards contradiction that there is $x_0 \in (0, \bar{x})$ such that $U(x_0) = 0$. Then we deduce from (7.63) that $U'(x_0) = 0$. By the uniqueness of the solution to the initial value problem, we have $U \equiv 0$ in $[0, \bar{x})$. This contradicts $U(0) > 0$.

Next, we solve (7.62) by dividing into three cases according to the sign of the mass $\int_0^{K_2} f_2(s)ds$.

Case 1. If $\int_0^{K_2} f_2(s)ds < 0$, one infers from (7.57) that $U(0) = \xi < K_1$ and thus $U'(0^+) < 0$. Moreover, one deduces from (7.63) that U' does not change sign in $[0^+, \bar{x})$. Therefore, $U' < 0$ in $[0^+, \bar{x})$. Since $U > 0$ in $[0, \bar{x})$, one has $0 < U(\cdot) < U(0) < K_1$ in $(0, \bar{x})$, whence $\bar{x} = +\infty$. Define $b := U(+\infty) \geq 0$. From (7.63), it follows that

$$\frac{d_2}{2}(U'(x))^2 \rightarrow \int_0^b f_2(s)ds \text{ as } x \rightarrow +\infty.$$

Hence, $U(+\infty) = b = 0$.

Case 2. If $\int_0^{K_2} f_2(s)ds = 0$, it follows from (7.57) that $U(0) = \xi < \min(K_1, K_2)$ and thus $U'(0^+) < 0$. We now show that $U' < 0$ in $(0, \bar{x})$. We assume by contradiction that there is $x_0 = \min\{x \in (0, \bar{x}) : U'(x) = 0\} > 0$, then it follows that $0 < U(x_0) < U(\cdot) < U(0) < \min(K_1, K_2)$ in $(0, x_0)$. On the other hand, taking $x = x_0$ in (7.63) together with the fact that $U > 0$ in $[0, \bar{x})$ implies that $U(x_0) = K_2$. This is a contradiction. Thus, $U' < 0$ in $[0^+, \bar{x})$, whence $0 < U(\cdot) < U(0)$ in $(0, \bar{x})$ and $\bar{x} = +\infty$. Following the same lines as in Case 1, one has $U(+\infty) = 0$.

Case 3. If $\int_0^{K_2} f_2(s)ds > 0$, we let $\theta^* \in (\theta, K_2)$ and $Q \in (K_2, +\infty)$ be such that $\int_0^{\theta^*} f_2(s)ds = \int_0^Q f_2(s)ds = 0$. From (7.57), it is seen that $U(0) = \xi \leq \theta^*$. Moreover, we observe from (7.63) that $U \notin (\theta^*, Q)$ in $[0, \bar{x})$. Recall that the bistable equation $d_2 u'' + f_2(u) = 0$ in \mathbb{R} admits an even bump-like solution $u(\cdot - x_0)$ for any $x_0 \in \mathbb{R}$, satisfying

$$u(0) = \theta^*, \quad u'(0) = 0, \quad u' < 0 \text{ in } (0, +\infty), \quad u(\pm\infty) = 0.$$

- (i) Suppose first that $U(0) = \xi = K_1 (\leq \theta^*)$, then $U'(0^+) = 0$ and necessarily $U(0) = K_1 = \theta^*$ by using (7.63). Then, by the uniqueness of the solution to the Cauchy problem, one derives that U is bump-like in $(0, +\infty)$ satisfying $U' < 0$ in $(0, +\infty)$ and $U(+\infty) = 0$.
- (ii) Suppose now that $K_1 < U(0) = \xi (\leq \theta^*)$, then $U'(0^+) > 0$. Then, necessarily $K_1 < U(0) = \xi < \theta^*$ by (7.63). Since $U \notin (\theta^*, Q)$ in $(0, \bar{x})$, one has $0 < U(\cdot) \leq \theta^*$ in $(0, \bar{x})$, whence $\bar{x} = +\infty$. Assume that $x_0 = \min\{x > 0 : U'(x) = 0\} > 0$, one has $U' > 0$ in $(0, x_0)$ and $U'(x_0) = 0$. Combining (7.63) with the fact that $0 < U(\cdot) \leq \theta^*$ in \mathbb{R}_+ , one has $U(x_0) = \theta^*$. Therefore, by the uniqueness of the solution to the Cauchy problem, U has to be bump-like in $(x_0, +\infty)$. Namely, $U(x_0) = \theta^*$, $U'(x_0) = 0$, $U' < 0$ in $(x_0, +\infty)$ and $U(+\infty) = 0$.
- (iii) Finally, let us assume $U(0) = \xi < K_1$. Then, $U'(0^+) < 0$. Remember also that $U(0) = \xi \leq \theta^*$. We now show that $U' < 0$ in $(0, \bar{x})$. If not, then there is $x_0 = \min\{x \in (0, \bar{x}) : U'(x) = 0\} > 0$ such that $U'(x_0) = 0$ and $0 < U(x_0) < U(\cdot) < U(0) \leq \theta^*$ in $(0, x_0)$. It follows from (7.63) that $0 = \frac{d_2}{2}(U'(x_0))^2 = -\int_0^{U(x_0)} f_2(s)ds > 0$. This is a contradiction. Consequently, $U' < 0$ in $(0, \bar{x})$ and $0 < U(\cdot) < U(0)$ in $(0, \bar{x})$, whence $\bar{x} = +\infty$. Repeating the argument as in Case 1, one has $U(+\infty) = 0$.

Gluing the solutions of (7.60) and (7.62) proves the existence of the desired stationary solution U of (7.3) such that $U(-\infty) = K_1$ and $U(+\infty) = 0$. Therefore, our claim at the beginning of the proof is achieved. The proof of Proposition 7.11 is complete. \square

Based on the above proof, counterexamples such that (7.3) has no stationary solution U connecting K_1 and 0 in the case $\int_0^{K_2} f_2(s)ds \geq 0$ can be easily constructed by some choices

7. Propagation and blocking in a two-patch reaction-diffusion model

of f_1, f_2, d_1, d_2 and σ . For instance, in the case of $\int_0^{K_2} f_2(s)ds > 0$, let us take $d_1 = d_2 = 1$, $\alpha = \frac{2}{3}$ and then $\sigma = \frac{1-\alpha}{\alpha} = \frac{1}{2}$. Set

$$f_1(u) = u(K_1 - u), \quad f_2(u) = u(K_2 - u)(u - \theta).$$

By taking $K_1 = K_2 = 6$ and $\theta = 2$, we see from (7.56) that $\xi > 6$, contradicting the condition $\xi \leq \theta^* < 6$ in (7.57). Therefore, there is no stationary solution U of (7.3) such that $U(-\infty) = K_1$ and $U(+\infty) = 0$.

Proof of Proposition 7.12. The strategy is very similar to that of Proposition 7.11. For completeness, we sketch the outline of the proof.

We first claim that the existence and uniqueness of a nonnegative bounded and classical stationary solution V of (7.3) satisfying $V(-\infty) = K_1$ and $V(+\infty) = K_2$ is equivalent to the existence and uniqueness of $\xi > 0$ such that

$$\begin{cases} \xi = K_1 = K_2, & \text{if } K_1 = K_2, \\ \min(K_1, K_2) < \xi < \max(K_1, K_2), & \text{if } K_1 \neq K_2, \end{cases} \quad (7.64)$$

and

$$\frac{1}{d_1} \int_{\xi}^{K_1} f_1(s)ds = \frac{\sigma^2}{d_2} \int_{\xi}^{K_2} f_2(s)ds. \quad (7.65)$$

We observe that such $\xi > 0$ satisfying (7.64)–(7.65) always exists and is unique. To check this, it is sufficient to consider the case of $K_1 \neq K_2$. Suppose $K_1 < K_2$. Since the function $\nu \mapsto \frac{1}{d_1} \int_{\nu}^{K_1} f_1(s)ds$ is continuous increasing in (K_1, K_2) and vanishes at K_1 , whereas the function $\nu \mapsto \frac{\sigma^2}{d_2} \int_{\nu}^{K_2} f_2(s)ds$ is continuous positive, and is either first increasing then decreasing in $[K_1, K_2)$ (if $K_1 < \theta$), or decreasing in $[K_1, K_2)$ (if $K_1 \geq \theta$), and vanishes at K_2 , it is derived that there is a unique $\xi \in (K_1, K_2)$ such that (7.65) is satisfied. Consider now the case of $K_2 < K_1$. Since the function $\nu \mapsto \frac{1}{d_1} \int_{\nu}^{K_1} f_1(s)ds$ is continuous decreasing in (K_2, K_1) and vanishes at K_1 , whereas the function $\nu \mapsto \frac{\sigma^2}{d_2} \int_{\nu}^{K_2} f_2(s)ds$ is continuous increasing in (K_2, K_1) and vanishes at K_2 , it follows that there is a unique $\xi \in (K_2, K_1)$ such that (7.65) is satisfied. Our observation is proved and this will complete the proof. Therefore, it is left with proving our claim.

Step 1. Suppose V is a unique, nonnegative, bounded and classical stationary solution of (7.3) satisfying $V(-\infty) = K_1$ and $V(+\infty) = K_2$. It follows from the strong maximum principle and the Hopf lemma that $V > 0$ in \mathbb{R} .

Multiplying $d_1 V'' + f_1(V) = 0$ by V' and integrating the resulting equation over $(-\infty, x)$ for any $x \in (-\infty, 0^-]$ finally yields

$$\frac{d_1}{2} (V'(x))^2 = \int_{V(x)}^{K_1} f_1(s)ds, \quad \forall x \in (-\infty, 0^-]. \quad (7.66)$$

Similarly, one also derives that

$$\frac{d_2}{2}(V'(x))^2 = \int_{V(x)}^{K_2} f_2(s)ds \geq 0, \quad \forall x \in [0^+, +\infty). \quad (7.67)$$

Following the argument as that of (7.61), one derives from (7.66) that V is monotone in patch 1, i.e.,

$$\begin{cases} \text{either} & V > K_1, \quad V' > 0 \text{ in } (-\infty, 0^-], \\ \text{or} & V < K_1, \quad V' < 0 \text{ in } (-\infty, 0^-], \\ \text{or} & V \equiv K_1 \text{ in } (-\infty, 0]. \end{cases}$$

Similarly, from (7.67) it follows that V is also monotone in patch 2, namely,

$$\begin{cases} \text{either} & V > K_2, \quad V' < 0 \text{ in } [0^+, +\infty), \\ \text{or} & V < K_2, \quad V' > 0 \text{ in } [0^+, +\infty), \\ \text{or} & V \equiv K_2 \text{ in } [0^+, +\infty). \end{cases}$$

Using $V'(0^-) = \sigma V'(0^+)$, one then infers that V is monotone in \mathbb{R} , more precisely,

$$\begin{cases} V \equiv K_1 = K_2, & \text{if } K_1 = K_2, \\ \min(K_1, K_2) < V(\cdot) < \max(K_1, K_2), \quad \text{sgn}(V') = \text{sgn}(V(0) - K_1), & \text{if } K_1 \neq K_2. \end{cases}$$

Moreover, thanks to (7.66) and (7.67), $V(0)$ satisfies

$$\frac{1}{d_1} \int_{V(0)}^{K_1} f_1(s)ds = \frac{\sigma^2}{d_2} \int_{V(0)}^{K_2} f_2(s)ds.$$

Hence, the quantity $\xi = V(0)$ satisfies (7.64)–(7.65), which is unique due to the continuity and monotonicity of V in \mathbb{R} .

Step 2. Assume that there is a unique $\xi > 0$ satisfying (7.64)–(7.65). Let us set $V(0) = \xi$ and define

$$V'(0^-) = \text{sgn}(V(0) - K_1) \sqrt{\frac{2}{d_1} \int_{V(0)}^{K_1} f_1(s)ds},$$

and

$$V'(0^+) = \text{sgn}(V(0) - K_1) \sqrt{\frac{2}{d_2} \int_{V(0)}^{K_2} f_2(s)ds}.$$

It is obvious to see that $V'(0^-) = \sigma V'(0^+)$, thanks to (7.65).

7. Propagation and blocking in a two-patch reaction-diffusion model

Step 2.1. Consider the Cauchy problem in \mathbb{R}_- :

$$\begin{cases} d_1 V'' + f_1(V) = 0, & x \in \mathbb{R}_-, \\ V(0) = \xi > 0, & V'(0^-) = \operatorname{sgn}(V(0) - K_1) \sqrt{\frac{2}{d_1} \int_{V(0)}^{K_1} f_1(s) ds}. \end{cases} \quad (7.68)$$

The property of the solution V to (7.68) is exactly the same as that of the solution to (7.60). Specifically, V is defined in $(-\infty, 0]$ and satisfies

$$\begin{cases} \text{either} & V > K_1, & V' > 0 & \text{in } (-\infty, 0^-], \\ \text{or} & V < K_1, & V' < 0 & \text{in } (-\infty, 0^-], \\ \text{or} & V \equiv K_1 & \text{in } (-\infty, 0]. \end{cases}$$

Step 2.2. Let V denote the solution of

$$\begin{cases} d_2 V'' + f_2(V) = 0, & x \in \mathbb{R}_+, \\ V(0) = \xi > 0, & V'(0^+) = \operatorname{sgn}(V(0) - K_1) \sqrt{\frac{2}{d_2} \int_{V(0)}^{K_2} f_2(s) ds}. \end{cases} \quad (7.69)$$

The Cauchy-Lipschitz theorem implies that there is a unique solution of (7.69) defined on a maximal interval $[0, \bar{x})$ for some $\bar{x} > 0$. Multiplying the equation in (7.69) by V' and then integrating over $(0^+, x)$ for any $x \in [0^+, \bar{x})$ yields that

$$\frac{d_2}{2} ((V'(x))^2 - (V'(0^+))^2) = \int_{V(x)}^{V(0)} f_2(s) ds, \quad \forall x \in [0^+, \bar{x}),$$

whence by using the formula of $V'(0^+)$, one has

$$\frac{d_2}{2} (V'(x))^2 = \int_{V(x)}^{K_2} f_2(s) ds, \quad \forall x \in [0^+, \bar{x}). \quad (7.70)$$

Suppose that $K_1 \neq K_2$, then $\min(K_1, K_2) < V(0) = \xi < \max(K_1, K_2)$. Moreover, we observe that

- V' has a strict constant sign in $[0^+, \bar{x})$. Assume by contradiction that there is $x_0 \in [0^+, \bar{x})$ such that $V'(x_0) = 0$. Then (7.70) implies that

$$\begin{cases} V(x_0) = K_2, & \text{if } \int_0^{K_2} f_2(s) ds > 0, \\ V(x_0) = K_2 \text{ or } 0, & \text{if } \int_0^{K_2} f_2(s) ds = 0, \end{cases}$$

If these were true, one would derive $V \equiv K_2$ or $V \equiv 0$ in $[0, +\infty)$ by the uniqueness of the solution to the Cauchy problem. This contradicts $\min(K_1, K_2) < V(0) = \xi <$

$\max(K_1, K_2)$.

- $V(\cdot) - K_2$ has a strict constant sign in $[0, \bar{x})$. Assume not, then there is $x_0 \in [0, \bar{x})$ such that $V(x_0) = K_2$. Then (7.70) implies that $V'(x_0) = 0$, which is impossible.

Therefore, we conclude that

$$\begin{cases} \text{if } K_1 < V(0) < K_2 \Rightarrow V' > 0 \text{ in } [0^+, \bar{x}), K_1 < V < K_2 \text{ in } (0, \bar{x}), \\ \text{if } K_2 < V(0) < K_1 \Rightarrow V' < 0 \text{ in } [0^+, \bar{x}), K_2 < V < K_1 \text{ in } (0, \bar{x}). \end{cases}$$

Both imply that $\bar{x} = +\infty$. Define $V(+\infty) = a$, then $K_1 \leq a \leq K_2$. Thus, (7.70) implies

$$\frac{d_2}{2}(V'(x))^2 \rightarrow \int_a^{K_2} f_2(s)ds \text{ as } x \rightarrow +\infty.$$

Hence, $V(+\infty) = a = K_2$.

For the special case $K_1 = K_2$, one has $V(0) = K_2$ and $V'(0^+) = 0$. The uniqueness of the solution to the Cauchy problem implies that $V \equiv K_2$ in $[0, +\infty)$.

By gluing the solutions of the above two Cauchy problems (7.68) and (7.69), one obtains the existence and uniqueness of a nonnegative, bounded and classical stationary solution V of (7.3) such that $V(-\infty) = K_1$ and $V(+\infty) = K_2$. The proof is thereby complete. \square

7.4.3 Blocking in the bistable patch 2: proofs of Theorems 7.13–7.15

In this section, we aim to study the qualitative behavior of the solution u to (7.3) in the bistable patch 2, and we here focus on the proofs of Theorems 7.13–7.15 on the blocking phenomena.

Proof of Theorem 7.13. (i) We first assume that $\int_0^{K_2} f_2(s)ds < 0$. The strategy of the proof consists essentially in constructing a supersolution which blocks the solution $u(t, x)$ for all large times as $x \rightarrow +\infty$.

Let us first introduce some parameters. Remember that $f_2'(0) < 0$ and $f_2'(K_2) < 0$. Let $\varepsilon > 0$ be such that

$$0 < \varepsilon < \min \left(\frac{\theta}{5}, \frac{K_2 - \theta}{5}, \sqrt{\frac{|f_2'(0)|}{2d_2}}, \sqrt{\frac{|f_2'(K_2)|}{2d_2}}, \frac{|f_2'(0)|}{2}, \frac{|f_2'(K_2)|}{2} \right), \quad (7.71)$$

$$f_2' \leq \frac{f_2'(0)}{2} \text{ in } [0, 5\varepsilon], \quad f_2' \leq \frac{f_2'(K_2)}{2} \text{ in } [K_2 - 5\varepsilon, +\infty).$$

Remember that ϕ is the unique traveling wave solution satisfying (7.12). Take $C > 0$ so large that

$$\phi \geq K_2 - \varepsilon \text{ in } (-\infty, -C], \quad \phi \leq \varepsilon \text{ in } [C, +\infty). \quad (7.72)$$

7. Propagation and blocking in a two-patch reaction-diffusion model

Due to the negativity and continuity of ϕ' on \mathbb{R} and due to the negativity of the speed c_2 (since $\int_0^{K_2} f_2(s)ds < 0$), there is $\kappa > 0$ such that (up to decreasing ε)

$$-\phi' \geq \kappa > 0 \text{ in } [-C, C], \quad -c_2\kappa > 2\varepsilon \left(\max_{[0, K_2]} |f_2'| + d_2\varepsilon^2 \right) \quad (7.73)$$

Finally, let $\rho > 0$ be such that

$$\kappa\rho \geq 2\varepsilon + 2 \max_{[0, K_2]} |f_2'|. \quad (7.74)$$

Let u be the solution to the Cauchy problem (7.3) with nonnegative continuous and compactly supported initial datum $u_0 \not\equiv 0$ and let w be the solution to (7.3) with initial condition $w_0(\cdot) = M := \max(K_1, K_2, \|u_0\|_{L^\infty(\mathbb{R})})$ in \mathbb{R} . Then Proposition 7.4 implies that w is nonincreasing in time and that $0 < u(t, x) < w(t, x) \leq M$ for all $t > 0$ and $x \in \mathbb{R}$. From standard parabolic estimates, $w(t, x)$ converges as $t \rightarrow +\infty$, locally uniformly in $x \in \mathbb{R}$, to a classical bounded stationary solution $W(x)$ of (7.3). Hence, $\limsup_{t \rightarrow +\infty} u(t, x) \leq W(x)$, locally uniformly in $x \in \mathbb{R}$. Thus, for any $\varepsilon > 0$, there is $t_2 > 0$ so large that

$$u(t, x) \leq W(x) + \varepsilon/2 \text{ for all } t \geq t_2, \text{ locally uniformly in } x \in \mathbb{R}. \quad (7.75)$$

Consider any sequence $(x_n)_{n \in \mathbb{N}}$ such that $x_n \rightarrow +\infty$ as $n \rightarrow +\infty$ and define $W_n(x) := W(x + x_n)$ for each $n \in \mathbb{N}$. By standard elliptic estimates, W_n converges, up to some subsequence, in $C_{loc}^2(\mathbb{R})$ as $n \rightarrow +\infty$ to a classical solution W_∞ of $d_2W_\infty'' + f_2(W_\infty) = 0$ in \mathbb{R} . From the assumption on f_2 , it follows that $\lim_{n \rightarrow +\infty} W_n(x) = W_\infty(x) \leq K_2$ in \mathbb{R} . Since $(x_n)_{n \in \mathbb{N}}$ was chosen arbitrarily, one has $\lim_{x \rightarrow +\infty} W(x) \leq K_2$. Therefore, there is $x_2 > 0$ large enough such that

$$W(x) \leq K_2 + \varepsilon/2 \text{ for all } x \geq x_2. \quad (7.76)$$

Combining (7.75) and (7.76), one deduces that

$$u(t, x_2) \leq W(x_2) + \varepsilon/2 \leq K_2 + \varepsilon \text{ for all } t \geq t_2. \quad (7.77)$$

By taking into account the exponential decay of $\phi(s)$ as $s \rightarrow +\infty$ in (7.13) and the Gaussian upper bound of $u(t_2, x)$ for all $x > 0$ large given in Lemma 7.36, one can choose $B > 0$ so large that

$$u(t_2, x) \leq \phi(x - x_2 - B - C) + 2\varepsilon \text{ for all } x \geq x_2. \quad (7.78)$$

Set

$$\bar{u}(t, x) = \phi(\zeta(t, x)) + 2\varepsilon e^{-\varepsilon(t-t_2)} + 2\varepsilon e^{-\varepsilon(x-x_2)} \text{ for } t \geq t_2 \text{ and } x \geq x_2,$$

where $\zeta(t, x) = x - x_2 + \rho e^{-\varepsilon(t-t_2)} - \rho - B - C$. Let us check that $\bar{u}(t, x)$ is a supersolution of $u_t = d_2u_{xx} + f_2(u)$ for all $t \geq t_2$ and $x \geq x_2$.

At time t_2 , one has $\bar{u}(t_2, x) \geq \phi(x - x_2 - B - C) + 2\varepsilon \geq u(t_2, x)$ for $x \geq x_2$, owing to (7.78). For $t \geq t_2$, there holds $\bar{u}(t, x_2) \geq \phi(-B - C) + 2\varepsilon \geq K_2 + \varepsilon \geq u(t, x_2)$, thanks to (7.72) and

(7.77). It then remains to check that $\mathcal{N}\bar{u}(t, x) := \bar{u}_t(t, x) - d_2\bar{u}_{xx}(t, x) - f_2(\bar{u}(t, x)) \geq 0$ for $t \geq t_2$ and $x \geq x_2$. By a direct computation, it comes that

$$\begin{aligned} \mathcal{N}\bar{u}(t, x) &= f_2(\phi(\zeta(t, x))) - f_2(\bar{u}(t, x)) + c_2\phi'(\zeta(t, x)) \\ &\quad - \phi'(\zeta(t, x))\rho\epsilon e^{-\epsilon(t-t_2)} - 2\epsilon^2 e^{-\epsilon(t-t_2)} - 2d_2\epsilon^3 e^{-\epsilon(x-x_2)}. \end{aligned}$$

We distinguish three cases.

If $\zeta(t, x) \leq -C$, one has $\phi(\zeta(t, x)) \geq K_2 - \epsilon$ and then $\bar{u}(t, x) \geq K_2 - \epsilon$. Thus, one derives from (7.71) that $f_2(\phi(\zeta(t, x))) - f_2(\bar{u}(t, x)) \geq -(f'_2(K_2)/2)(2\epsilon e^{-\epsilon(t-t_2)} + 2\epsilon e^{-\epsilon(x-x_2)})$, and

$$\begin{aligned} \mathcal{N}\bar{u}(t, x) &\geq -\frac{f'_2(K_2)}{2} \left(2\epsilon e^{-\epsilon(t-t_2)} + 2\epsilon e^{-\epsilon(x-x_2)} \right) - 2\epsilon^2 e^{-\epsilon(t-t_2)} - 2d_2\epsilon^3 e^{-\epsilon(x-x_2)} \\ &= \left(-\frac{f'_2(K_2)}{2} - \epsilon \right) 2\epsilon e^{-\epsilon(t-t_2)} + \left(-\frac{f'_2(K_2)}{2} - d_2\epsilon^2 \right) 2\epsilon e^{-\epsilon(x-x_2)} \geq 0. \end{aligned}$$

If $\zeta(t, x) \geq C$, then $\phi(\zeta(t, x)) \leq \epsilon$ and $\bar{u}(t, x) \leq 5\epsilon$. It follows from (7.71) that $f_2(\phi(\zeta(t, x))) - f_2(\bar{u}(t, x)) \geq -(f'_2(0)/2)(2\epsilon e^{-\epsilon(t-t_2)} + 2\epsilon e^{-\epsilon(x-x_2)})$, and

$$\begin{aligned} \mathcal{N}\bar{u}(t, x) &\geq -\frac{f'_2(0)}{2} \left(2\epsilon e^{-\epsilon(t-t_2)} + 2\epsilon e^{-\epsilon(x-x_2)} \right) - 2\epsilon^2 e^{-\epsilon(t-t_2)} - 2d_2\epsilon^3 e^{-\epsilon(x-x_2)} \\ &= \left(-\frac{f'_2(0)}{2} - \epsilon \right) 2\epsilon e^{-\epsilon(t-t_2)} + \left(-\frac{f'_2(0)}{2} - d_2\epsilon^2 \right) 2\epsilon e^{-\epsilon(x-x_2)} \geq 0. \end{aligned}$$

Eventually, if $-C \leq \zeta(t, x) \leq C$, then $\phi'(\zeta(t, x)) \leq -\kappa < 0$. One infers from (7.73) and (7.74) that

$$\begin{aligned} \mathcal{N}\bar{u}(t, x) &\geq -\max_{[0, K_2]} |f'_2| \left(2\epsilon e^{-\epsilon(t-t_2)} + 2\epsilon e^{-\epsilon(x-x_2)} \right) - c_2\kappa \\ &\quad + \kappa\rho\epsilon e^{-\epsilon(t-t_2)} - 2\epsilon^2 e^{-\epsilon(t-t_2)} - 2d_2\epsilon^3 e^{-\epsilon(x-x_2)} \\ &\geq \left(\kappa\rho - 2\max_{[0, K_2]} |f'_2| - 2\epsilon \right) \epsilon e^{-\epsilon(t-t_2)} + \left(-c_2\kappa - 2\epsilon\max_{[0, K_2]} |f'_2| - 2d_2\epsilon^3 \right) e^{-\epsilon(x-x_2)} \geq 0. \end{aligned}$$

As a conclusion, the function $\bar{u}(t, x)$ is a supersolution of $u_t = d_2u_{xx} + f_2(u)$ for $t \geq t_2$, $x \geq x_2$. Then the maximum principle implies that for $t \geq t_2$ and $x \geq x_2$,

$$u(t, x) \leq \phi(x - x_2 + \rho e^{-\epsilon(t-t_2)} - \rho - B - C) + 2\epsilon e^{-\epsilon(t-t_2)} + 2\epsilon e^{-\epsilon(x-x_2)}.$$

Consequently, passing to the limit $x \rightarrow +\infty$, it can be deduced that $u(t, x) \leq 3\epsilon$ uniformly for $t \geq t_2$. On the other hand, we infer from Lemma 7.36 that $u(t, x) \rightarrow 0$ as $x \rightarrow +\infty$ locally uniformly in $t \geq 0$. Therefore, u is blocked in patch 2 and satisfies (7.15).

(ii) We then assume that $\int_0^{K_2} f_2(s)ds = 0$ and $K_1 < K_2$. First, it is convenient to

7. Propagation and blocking in a two-patch reaction-diffusion model

introduce some parameters. Let $\varepsilon > 0$ be such that

$$\begin{aligned} 0 < \varepsilon < \min \left(\frac{\theta}{2}, \frac{K_2 - \theta}{2}, \frac{|f_2'(0)|}{2}, \frac{|f_2'(K_2)|}{2} \right), \\ f_2' \leq \frac{f_2'(0)}{2} \text{ in } [0, 2\varepsilon], \quad f_2' \leq \frac{f_2'(K_2)}{2} \text{ in } [K_2 - 2\varepsilon, +\infty). \end{aligned} \quad (7.79)$$

Choose $C > 0$ large enough such that

$$\phi \geq K_2 - \varepsilon \text{ in } (-\infty, -C], \quad \phi \leq \varepsilon \text{ in } [C, +\infty). \quad (7.80)$$

Since ϕ' is negative and continuous in \mathbb{R} , there exists $\kappa > 0$ such that

$$-\phi' \geq \kappa > 0 \text{ in } [-C, C]. \quad (7.81)$$

Finally, pick $\rho > 0$ be such that

$$\kappa\rho \geq \varepsilon + \max_{[0, K_2]} |f_2'|. \quad (7.82)$$

Let u be the solution to the Cauchy problem (7.3) with nonnegative continuous and compactly supported initial datum $u_0 \not\equiv 0$ and let V be the unique increasing stationary solution of (7.3) such that $V(-\infty) = K_1$ and $V(+\infty) = K_2$ given in Proposition 7.12. Define by w the solution to (7.3) with initial condition $w_0(\cdot) = M := \max(K_2, \|u_0\|_{L^\infty(\mathbb{R})})$ in \mathbb{R} . Then Proposition 7.4 implies that w is decreasing in time, $0 < u(t, x) < w(t, x) < M$ and $V(x) < w(t, x)$ for all $t > 0$ and $x \in \mathbb{R}$. By parabolic estimates, $w(t, x)$ converges as $t \rightarrow +\infty$, locally uniformly in $x \in \mathbb{R}$, to a stationary solution $q(x)$ of (7.3). As shown in Theorem 7.8, one has $q(-\infty) = K_1$. Moreover, $V \leq q$ in \mathbb{R} and

$$\limsup_{t \rightarrow +\infty} u(t, \cdot) \leq q, \text{ locally uniformly in } \mathbb{R}. \quad (7.83)$$

We now claim that $q = V$ in \mathbb{R} . To do so, we first show that q is stable in $\overline{\mathbb{R}}_+$ in the sense that $\int_0^{+\infty} |\varphi'|^2 - f_2'(q)\varphi^2 \geq 0$ for every $\varphi \in C^1(\overline{\mathbb{R}}_+)$ with compact support, by using a direct argument as in [100]. Indeed, we first observe that

$$0 \leq -w_t = d_2(q - w)_{xx} + f_2(q) - f_2(w) \text{ for } t > 0 \text{ and } x > 0.$$

Consider now any $C^1(\overline{\mathbb{R}}_+)$ function φ with compact support. Multiplying the above equation by the nonnegative function $\varphi^2/(w(t, \cdot) - q)$ and integrating by parts over \mathbb{R}_+ at each fixed

time $t > 0$ yields that

$$\begin{aligned}
 0 &\leq \int_0^{+\infty} d_2(w(t, \cdot) - q)' \left(\frac{\varphi^2}{w(t, \cdot) - q} \right)' - \frac{f_2(w(t, \cdot)) - f_2(q)}{w(t, \cdot) - q} \varphi^2 \\
 &= \int_0^{+\infty} d_2 \left(2 \frac{\varphi(w(t, \cdot) - q)' \varphi'}{w(t, \cdot) - q} - \frac{|(w(t, \cdot) - q)'|^2 \varphi^2}{(w(t, \cdot) - q)^2} \right) - \frac{f_2(w(t, \cdot)) - f_2(q)}{w(t, \cdot) - q} \varphi^2 \\
 &\leq \int_0^{K_2} d_2 |\varphi'|^2 - \frac{f_2(w(t, \cdot)) - f_2(q)}{w(t, \cdot) - q} \varphi^2.
 \end{aligned}$$

Since $w(t, \cdot) \rightarrow q$ as $t \rightarrow +\infty$ locally uniformly in \mathbb{R} , passing to the limit as $t \rightarrow +\infty$ implies

$$0 \leq \int_0^{+\infty} d_2 |\varphi'|^2 - f_2'(q) \varphi^2.$$

Therefore, q is stable in $\overline{\mathbb{R}}_+$. Next, we prove that $q(+\infty) = K_2$. Indeed, if there is $x_0 \in \overline{\mathbb{R}}_+$ such that $q(x_0) = K_2$ and since q satisfies $d_2 q'' + f_2(q) = 0$ in \mathbb{R}_+ , the Cauchy-Lipschitz theorem then implies $q \equiv K_2$ in $\overline{\mathbb{R}}_+$ and $q'(0) = 0$, whence $q \equiv K_1$ in $\overline{\mathbb{R}}_-$. This is true if and only if $K_1 = K_2$, i.e. $q \equiv K_1 = K_2$ in \mathbb{R} . In the sequel, we assume that $q(\cdot) - K_2$ has a strict constant sign in $\overline{\mathbb{R}}_+$. Assume first that q has at least two critical points $0 \leq a < b < +\infty$ such that $q'(a) = q'(b) = 0$. By reflection, set $z_1 := q(2b - \cdot)$ in $[b, 2b - a]$, then z_1 satisfies

$$\begin{cases} d_2 z_1'' + f_2(z_1) = 0, & \text{in } [b, 2b - a], \\ z_1(b) = q(b), \quad z_1'(b) = q'(b) = 0. \end{cases}$$

The Cauchy-Lipschitz theorem implies that $z_1 = q$ in $[b, 2b - a]$. Thus, $q(2b - a) = q(a)$ and $q'(2b - a) = 0$. Again using reflection, we set $z_2 := q(4b - 2a - \cdot)$ in $[2b - a, 4b - 3a]$ and apply the Cauchy-Lipschitz theorem, it follows that $z_2 = q$ in $[2b - a, 4b - 3a]$. Repeating above procedures gives that q is periodic in $[a, +\infty)$. This is impossible since q is stable in $\overline{\mathbb{R}}_+$. Therefore, q has at most one critical point in $\overline{\mathbb{R}}_+$. This implies that q has to be monotone in, say, $[R, +\infty)$ for some $R > 0$ large. Therefore, $q(+\infty)$ exists and then $q(+\infty)$ can only be K_2 or 0, due to the stability of q in $\overline{\mathbb{R}}_+$. Since $q \geq V$ in \mathbb{R} and $V(+\infty) = K_2$, one has $q(+\infty) = K_2$. Consequently, $q = V$ in \mathbb{R} by the uniqueness of the stationary solution of (7.3) connecting K_1 and K_2 . Our claim is achieved.

Since $K_1 < q < K_2$ in \mathbb{R} , one can pick $X > 0$ so large that $q(X) \leq K_2 - \varepsilon$. Thanks to (7.83), there is $T > 0$ so large that

$$u(t, X) \leq q(X) \leq K_2 - \varepsilon \text{ for all } t \geq T. \quad (7.84)$$

Moreover, due to the Gaussian upper bound of $u(t, x)$ for $|x|$ large at each time $t > 0$ derived in Lemma 7.36 and due to the exponential upper bound of $\phi(s)$ in (7.13), there exists $B > 0$

7. Propagation and blocking in a two-patch reaction-diffusion model

large enough such that

$$u(T, x) \leq \phi(x - X - B - C) + \varepsilon \text{ for all } x \geq X. \quad (7.85)$$

Define

$$\bar{u}(t, x) = \phi(\zeta(t, x)) + \varepsilon e^{-\varepsilon(t-T)} \text{ for } t \geq T \text{ and } x \geq X,$$

where $\zeta(t, x) = x - X + \rho e^{-\varepsilon(t-T)} - \rho - B - C$. We wish to show that $\bar{u}(t, x)$ is a supersolution of $u_t = d_2 u_{xx} + f_2(u)$ for all $t \geq T$ and $x \geq X$.

At time $t = T$, one has $\bar{u}(T, x) \geq \phi(x - X - B - C) + \varepsilon \geq u(T, x)$ for all $x \geq X$, thanks to (7.85). For all $t \geq T$, $\bar{u}(t, X) \geq K_2 - \varepsilon \geq u(t, X)$ by (7.80) and (7.84). It then remains to check that $\mathcal{N}\bar{u}(t, x) := \bar{u}_t(t, x) - d_2 \bar{u}_{xx}(t, x) - f_2(\bar{u}(t, x)) \geq 0$ for $t \geq T$ and $x \geq X$. A direct computation leads to

$$\mathcal{N}\bar{u}(t, x) = f_2(\phi(\zeta(t, x))) - f_2(\bar{u}(t, x)) - \phi'(\zeta(t, x))\rho\varepsilon e^{-\varepsilon(t-T)} - \varepsilon^2 e^{-\varepsilon(t-T)}.$$

We divide into three cases.

If $\zeta(t, x) \leq -C$, one has $\bar{u}(t, x) \geq \phi(\zeta(t, x)) \geq K_2 - \varepsilon$. One then derives from (7.79) that

$$\mathcal{N}\bar{u}(t, x) \geq -\frac{f_2'(K_2)}{2}\varepsilon e^{-\varepsilon(t-T)} - \varepsilon^2 e^{-\varepsilon(t-T)} = \left(-\frac{f_2'(K_2)}{2} - \varepsilon\right)\varepsilon e^{-\varepsilon(t-T)} \geq 0.$$

If $\zeta(t, x) \geq C$, then $\phi(\zeta(t, x)) \leq \varepsilon$ and $\bar{u}(t, x) \leq 2\varepsilon$. It follows from (7.79) that

$$\mathcal{N}\bar{u}(t, x) \geq -\frac{f_2'(0)}{2}\varepsilon e^{-\varepsilon(t-T)} - \varepsilon^2 e^{-\varepsilon(t-T)} = \left(-\frac{f_2'(0)}{2} - \varepsilon\right)\varepsilon e^{-\varepsilon(t-T)} \geq 0.$$

Eventually, if $-C \leq \zeta(t, x) \leq C$, then $-\phi'(\zeta(t, x)) \geq \kappa > 0$ by (7.81). One infers from (7.81)–(7.82) that

$$\begin{aligned} \mathcal{N}\bar{u}(t, x) &\geq -\max_{[0, K_2]} |f_2'| \varepsilon e^{-\varepsilon(t-T)} + \kappa \rho \varepsilon e^{-\varepsilon(t-T)} - \varepsilon^2 e^{-\varepsilon(t-T)} \\ &\geq \left(\kappa \rho - \max_{[0, K_2]} |f_2'| - \varepsilon\right) \varepsilon e^{-\varepsilon(t-T)} \geq 0. \end{aligned}$$

In conclusion, the function $\bar{u}(t, x)$ is a supersolution of $u_t = d_2 u_{xx} + f_2(u)$ for $t \geq T$ and $x \geq X$. The maximum principle implies that

$$u(t, x) \leq \phi(x - X + \rho e^{-\varepsilon(t-T)} - \rho - B - C) + \varepsilon e^{-\varepsilon(t-T)} \text{ for } t \geq T \text{ and } x \geq X.$$

Consequently, passing to the limit as $x \rightarrow +\infty$, it follows that $u(t, x) \leq 2\varepsilon$ uniformly for $t \geq T$. On the other hand, Lemma 7.36 implies that $u(t, x) \rightarrow 0$ as $x \rightarrow +\infty$ locally uniformly in $t \geq 0$. Therefore, u is blocked in patch 2 and satisfies (7.15). This completes the proof. \square

Proof of Theorem 7.14. Assume that $K_1 < \theta$. Let u be the solution to (7.3) with nonnegative continuous and compactly supported initial value $u_0 \not\equiv 0$ satisfying $u_0 < \theta$ in \mathbb{R} . Proposition 7.4 then implies $0 < u(t, x) < M := \max(K_1, \|u_0\|_{L^\infty(\mathbb{R})}) < \theta$ for all $t \geq 0$ and $x \in \mathbb{R}$.

Choose $\varepsilon > 0$ small and let g_2 be of class C^1 on $[0, K_2]$ such that $g_2 = f_2$ in $(0, \theta)$, $g_2 > 0$ in $(\theta, \theta + \varepsilon)$, $g_2 = 0$ in $[\theta + \varepsilon, K_2]$, and $\int_0^{\theta+\varepsilon} g_2(s) ds < 0$. Let z be the solution to (7.3) in which f_2 is replaced by g_2 starting from the initial value u_0 . By comparison, one has $u(t, x) = z(t, x)$ for $t \geq 0$ and $x \in \mathbb{R}$. Thanks to Theorem 7.13, it is immediate to see that z is blocked in patch 2 and z satisfies (7.15), which is also true for u . The conclusion is therefore achieved. \square

Proof of Theorem 7.15. Fix any $L > 0$. Let u be the solution to the Cauchy problem (7.3) with initial function $u_0 \geq 0$ satisfying $\text{spt}(u_0) \subset [-L, L]$ and $\|u_0\|_{L^1(\mathbb{R})}$ sufficiently small. Assume that (7.3) admits a nonnegative classical stationary solution U such that $U(-\infty) = K_1$ and $U(+\infty) = 0$. If $u_0 \leq U$ in \mathbb{R} , the conclusion of Theorem 7.15 immediately follows. Let us now discuss the general case.

By a rescaling of space in patch 2, namely,

$$\tilde{u}(t, x) = \begin{cases} u(t, x), & \text{for } t \geq 0, x < 0, \\ u(t, \sqrt{d_2/d_1}x) & \text{for } t \geq 0, x \geq 0. \end{cases}$$

we see that $\tilde{u}(t, x)$ satisfies

$$\begin{cases} \tilde{u}_t = d_1 \tilde{u}_{xx} + f_1(\tilde{u}), & t > 0, x < 0, \\ \tilde{u}_t = d_1 \tilde{u}_{xx} + f_2(\tilde{u}), & t > 0, x > 0, \\ \tilde{u}(t, 0^-) = \tilde{u}(t, 0^+), & t > 0, \\ \tilde{u}_x(t, 0^-) = \sigma \sqrt{d_1/d_2} \tilde{u}_x(t, 0^+), & t > 0. \end{cases}$$

Since $\|u_0\|_{L^1(\mathbb{R})}$ is small, it is seen that $\|\tilde{u}_0(x)\|_{L^1(\mathbb{R})} = \|u_0\|_{L^1(-\infty, 0)} + \sqrt{d_1/d_2} \|u_0\|_{L^1(0, +\infty)}$ remains small. Therefore, without loss of generality, it is not restrictive to assume that $d_1 = d_2 =: d$ in (7.3).

By the assumption on f_1 and f_2 , it is easy to see that (7.126) is satisfied for some $K > 0$. Let v be the solution of the initial value problem

$$\begin{cases} v_t = dv_{xx} + Kv, & t > 0, x \in \mathbb{R}, \\ v_0(x) = u_0(x) + u_0(-x), & x \in \mathbb{R}. \end{cases}$$

Since $u_0 \geq 0$ satisfies $\text{spt}(u_0) \subset [-L, L]$, so does v_0 . By the uniqueness of the solution, we see that v is even and smooth with respect to x , whence $v_x(t, 0) = 0$. Proposition 7.4 implies that $u(t, x) \leq v(t, x)$ for all $t \geq 0$ and $x \in \mathbb{R}$.

7. Propagation and blocking in a two-patch reaction-diffusion model

We claim that $v(1, \cdot) \leq U$ in \mathbb{R} provided $\|u_0\|_{L^1(\mathbb{R})}$ is very small. Indeed, we notice that

$$v(1, x) \leq \frac{e^K}{\sqrt{4\pi d}} \int_{\mathbb{R}} e^{-\frac{|x-y|^2}{4d}} v_0(y) dy \leq \frac{e^K}{\sqrt{4\pi d}} \|v_0\|_{L^1(\mathbb{R})} = \frac{e^K}{\sqrt{\pi d}} \|u_0\|_{L^1(\mathbb{R})},$$

whence

$$v(1, x) \leq \min_{(-\infty, 2L]} U \text{ for all } x \leq 2L,$$

provided that there is $\varepsilon > 0$ small enough (depending on L) such that

$$\|u_0\|_{L^1(\mathbb{R})} \leq \varepsilon \leq \frac{\sqrt{\pi d}}{e^K} \min_{(-\infty, 2L]} U.$$

On the other hand,

$$v(1, x) \leq \frac{e^K}{\sqrt{4\pi d}} \int_{-L}^L e^{-\frac{|x-y|^2}{4d}} v_0(y) dy \leq \frac{e^{K-\frac{x^2}{16d}}}{\sqrt{4\pi d}} \int_{-L}^L v_0(y) dy = \frac{e^K}{\sqrt{\pi d}} \|u_0\|_{L^1(\mathbb{R})} e^{-\frac{x^2}{16d}} \text{ for } x \geq 2L,$$

since $\text{spt}(v_0) \subset [-L, L]$ and since $y \leq L \leq \frac{x}{2}$ and $x - y \geq \frac{x}{2} > 0$. Observe also that $U(x) = O(e^{-\sqrt{-f_2'(0)/d_2}x})$ as $x \rightarrow +\infty$. Thus,

$$v(1, x) \leq \frac{e^K}{\sqrt{\pi d}} \|u_0\|_{L^1(\mathbb{R})} e^{-\frac{x^2}{16d}} \leq U(x) \text{ for all } x \geq 2L,$$

provided that $\|u_0\|_{L^1(\mathbb{R})} \leq \varepsilon$ (up to decreasing ε if needed). Consequently, $v(1, \cdot) \leq U$ in \mathbb{R} provided $\|u_0\|_{L^1(\mathbb{R})}$ is very small.

Therefore, one has $u(1, x) \leq v(1, x) \leq U(x)$ in \mathbb{R} . By a comparison argument, $u(t, x) \leq U(x)$ for all $t \geq 1$ and $x \in \mathbb{R}$. Hence, $u(t, x) \rightarrow 0$ as $x \rightarrow +\infty$ uniformly in $t \geq 1$. Together with the result in Lemma 7.36 that $u(t, x) \rightarrow 0$ as $x \rightarrow +\infty$ locally uniformly in $t \geq 0$, we conclude that u is blocked in patch 2 and satisfies (7.15). The proof of Theorem 7.15 is therefore complete. \square

7.4.4 Propagation in the bistable patch 2: proofs of Theorems 7.16–7.17

This section is devoted to the proofs of Theorems 7.16–7.17 on propagation phenomena with positive speed or speed zero in the bistable patch 2.

The following auxiliary lemma gives the existence of solutions to the elliptic equations in large intervals. The proof is based on variational methods, see, for instance, [26, Theorem A] and [88, Problem (2.25)]. We omit it here.

Lemma 7.28. *Assume that (7.11) holds and $\int_0^{K_2} f_2(s)ds > 0$. Then there exist $R > 0$ and a function ψ of class $C^2([-R, R])$ such that*

$$\begin{cases} d_2\psi'' + f_2(\psi) = 0, & \text{in } [-R, R], \\ 0 \leq \psi < K_2, & \text{in } [-R, R], \\ \psi = 0, & \text{at } x = \pm R, \\ \max_{[-R, R]} \psi = \psi(0) > \theta. \end{cases} \quad (7.86)$$

To prove Theorem 7.16, we take a roundabout way to prove the following result as a first step.

Theorem 7.29. *Assume that (7.10)–(7.11) hold and that $\int_0^{K_2} f_2(s)ds > 0$. Let $R > 0$ and ψ be as in Lemma 7.28. Let u be the solution to (7.3) with nonnegative continuous and compactly supported initial function $u_0 \not\equiv 0$. If $u_0 \geq \psi(\cdot - x_0)$ in \mathbb{R} for some $x_0 \geq R$, then the conclusion of Theorem 7.16 still holds true.*

Proof of Theorem 7.29 (beginning). Let $R > 0$ and ψ be as in Lemma 7.28. Let u be the solution to (7.3) with nonnegative continuous and compactly supported initial function $u_0 \not\equiv 0$ and $u_0 \geq \psi(\cdot - x_0)$ in \mathbb{R} for some $x_0 \geq R$. Let v and w be, respectively, the solutions to (7.3) with initial functions $v_0 = M := \max(K_1, K_2, \|u_0\|_{L^\infty(\mathbb{R})})$ and w_0 in \mathbb{R} , where w_0 is given by $w_0 = \psi(\cdot - x_0)$ in $[x_0 - R, x_0 + R]$ and $w_0 = 0$ elsewhere in \mathbb{R} . Then Proposition 7.4 yields that $0 < w(t, x) \leq u(t, x) \leq v(t, x) \leq M$ for all $t > 0$ and $x \in \mathbb{R}$. Moreover, w is increasing in time, whereas v is nonincreasing in time. From standard parabolic estimates, the functions $w(t, \cdot)$ and $v(t, \cdot)$ converge as $t \rightarrow +\infty$, locally uniformly in \mathbb{R} , to classical stationary solutions p and q of (7.3), respectively. Moreover,

$$w_0 < p \leq \liminf_{t \rightarrow +\infty} u(t, \cdot) \leq \limsup_{t \rightarrow +\infty} u(t, \cdot) \leq q \leq M, \text{ locally uniformly in } \mathbb{R}. \quad (7.87)$$

Let us now show that

$$p(x) \rightarrow K_2 \text{ as } x \rightarrow +\infty. \quad (7.88)$$

As a matter of fact, since $p > w_0$ in \mathbb{R} , by continuity there exists $\varrho_0 > 1$ such that $p > \psi(\cdot - \varrho x_0)$ in $[\varrho x_0 - R, \varrho x_0 + R]$ for all $\varrho \in [1, \varrho_0]$. Define

$$\varrho^* = \sup \{ \varrho > 0 : p > \psi(\cdot - \tilde{\varrho}x_0) \text{ in } [\tilde{\varrho}x_0 - R, \tilde{\varrho}x_0 + R] \text{ for all } \tilde{\varrho} \in [1, \varrho] \}.$$

Then it is obvious to see that $\varrho^* \geq \varrho_0 > 1$. We claim that $\varrho^* = +\infty$. Assume not, then by the definition of ϱ^* , one has $p \geq \psi(\cdot - \varrho^*x_0)$ in $[\varrho^*x_0 - R, \varrho^*x_0 + R]$ with equality somewhere in $(\varrho^*x_0 - R, \varrho^*x_0 + R)$, due to $p > 0$ in \mathbb{R} and $\psi(\pm R) = 0$. The elliptic strong maximum principle then implies that $p \equiv \psi(\cdot - \varrho^*x_0)$ in $[\varrho^*x_0 - R, \varrho^*x_0 + R]$, which is impossible. Thus, we conclude that $\varrho^* = +\infty$ and $p > \psi(\cdot - \varrho x_0)$ in $[\varrho x_0 - R, \varrho x_0 + R]$ for all $\varrho \geq 1$. In

7. Propagation and blocking in a two-patch reaction-diffusion model

particular, this implies that

$$p(x) > \psi(0) > \theta \text{ for all } x \geq x_0.$$

Consider an arbitrary sequence $(x_n)_{n \in \mathbb{N}}$ diverging to $+\infty$ as $n \rightarrow +\infty$. From standard elliptic estimates, up to extraction of a subsequence, the functions $p_n := p(\cdot + x_n)$ converge as $n \rightarrow +\infty$, in $C_{loc}^2(\mathbb{R})$ to a classical solution p_∞ of $d_2 p_\infty'' + f_2(p_\infty) = 0$ in \mathbb{R} which satisfies $\theta < \psi(0) \leq p_\infty(\cdot) \leq M$ in \mathbb{R} . The comparison principle then implies that $p_\infty \geq \zeta(t)$ for all $t \geq 0$ and $x \in \mathbb{R}$, where $\zeta(t)$ is such that $\zeta'(t) = f_2(\zeta(t))$ for $t \geq 0$ and $\zeta(0) = \psi(0) > \theta$. Since $f_2 > 0$ in (θ, K_2) and $f_2(K_2) = 0$, one has $\zeta(t) \nearrow K_2$ as $t \rightarrow +\infty$. Hence, $p_\infty \geq K_2$ in \mathbb{R} . Consider $\xi(t) = f(\xi(t))$ for $t \geq 0$ and $\xi(0) = M$, we see that $\xi(t) \searrow K_2$ as $t \rightarrow +\infty$, since $f_2 < 0$ on $(K_2, +\infty)$. By comparison, it follows that $p_\infty(x) \leq \xi(t)$ for all $t \geq 0$ and $x \in \mathbb{R}$, whence $p_\infty \leq K_2$ in \mathbb{R} . Consequently, $p_\infty \equiv K_2$ in \mathbb{R} . Since $(x_n)_{n \in \mathbb{N}}$ was arbitrarily chosen, (7.88) is achieved.

Likewise, for any sequence $(x_n)_{n \in \mathbb{N}}$ diverging to $+\infty$ as $n \rightarrow +\infty$, it follows from elliptic estimates that the functions $q_n := q(\cdot + x_n)$ converge, up to some subsequence, in $C_{loc}^2(\mathbb{R})$ to a classical solution q_∞ of $d_2 q_\infty'' + f_2(q_\infty) = 0$ in \mathbb{R} with $q_\infty \geq p_\infty = K_2$ in \mathbb{R} . By comparing q_∞ and $\xi(t)$ which was given above, one finally derives

$$q(x) \rightarrow K_2 \text{ as } x \rightarrow +\infty. \quad (7.89)$$

The rest of the proof of Theorem 7.29 relies on the following several preliminaries.

Lemma 7.30. *Under the assumptions of Theorem 7.29, there exist $X > 0$, $T_1 > 0$, $T_2 > 0$, $z_1 \in \mathbb{R}$, $z_2 \in \mathbb{R}$, $\mu > 0$ and $\delta > 0$ such that*

$$u(t, x) \leq \phi(x - c_2(t - T_1) + z_1) + 2\delta e^{-\delta(t-T_1)} + 2\delta e^{-\mu(x-X)} \text{ for all } t \geq T_1 \text{ and } x \geq X, \quad (7.90)$$

and

$$u(t, x) \geq \phi(x - c_2(t - T_2) + z_2) - \delta e^{-\delta(t-T_2)} - \delta e^{-\mu(x-X)} \text{ for all } t \geq T_2 \text{ and } x \geq X. \quad (7.91)$$

Proof. We first introduce some parameters. Choose $\mu > 0$ such that

$$0 < \mu < \sqrt{\min\left(\frac{|f_2'(0)|}{2d_2}, \frac{|f_2'(K_2)|}{2d_2}\right)}. \quad (7.92)$$

Then we take $\delta > 0$ such that (we notice that $c_2 > 0$)

$$\begin{aligned} 0 < \delta < \min \left(\mu c_2, \frac{\theta}{5}, \frac{K_2 - \theta}{5}, \frac{|f_2'(0)|}{2}, \frac{|f_2'(K_2)|}{2} \right), \\ f_2' \leq \frac{f_2'(0)}{2} \text{ in } [0, 5\delta], \quad f_2' \leq \frac{f_2'(K_2)}{2} \text{ in } [K_2 - 5\delta, +\infty). \end{aligned} \quad (7.93)$$

Let $C > 0$ be such that

$$\phi \geq K_2 - \delta \text{ in } (-\infty, -C], \quad \phi \leq \delta \text{ in } [C, +\infty).$$

Since $\phi' < 0$ is continuous in \mathbb{R} , there is $\kappa > 0$ such that

$$\phi' \leq -\kappa < 0 \text{ in } [-C, C], \quad (7.94)$$

and then take $\omega > 0$ so that

$$\kappa\omega \geq 4\delta + 2 \max_{[0, K_2]} |f_2'|. \quad (7.95)$$

Finally, pick $B > \omega$ so large that

$$\left(\max_{[0, K_2]} |f_2'| + d_2\mu^2 \right) e^{-\mu B} < \left(\max_{[0, K_2]} |f_2'| + d_2\mu^2 \right) e^{-\mu(B-\omega)} \leq \delta. \quad (7.96)$$

Step 1. Proof of (7.90). Since $q(x) \rightarrow K_2$ as $x \rightarrow +\infty$ by (7.89), there is $X > 0$ large enough such that $|q(x) - K_2| \leq \delta$ for all $x \geq X$. Due to (7.87) that $\limsup_{t \rightarrow +\infty} u(t, x) \leq q(x)$ locally uniformly in $x \in \mathbb{R}$, one can choose $T_1 > 0$ sufficiently large such that

$$u(t, X) \leq q(X) \leq K_2 + \delta \text{ for all } t \geq T_1. \quad (7.97)$$

Moreover, since $u(t, x)$ has a Gaussian upper bound at each fixed $t > 0$ for all $|x|$ large enough by Lemma 7.36, whereas $\phi(s)$ has an exponential bound (7.13) as $s \rightarrow +\infty$, there holds (up to increasing B if needed)

$$u(T_1, x) \leq \phi(x - X - B - C) + 2\delta \text{ for all } x \geq X. \quad (7.98)$$

For $t \geq T_1$ and $x \geq X$, let us define

$$\bar{u}(t, x) = \phi(\bar{\xi}(t, x)) + 2\delta e^{-\delta(t-T_1)} + 2\delta e^{-\mu(x-X)},$$

where

$$\bar{\xi}(t, x) = x - X - c_2(t - T_1) + \omega e^{-\delta(t-T_1)} - \omega - B - C.$$

Let us now check that $\bar{u}(t, x)$ is a supersolution to $u_t = d_2 u_{xx} + f_2(u)$ for all $t \geq T_1$ and $x \geq X$.

7. Propagation and blocking in a two-patch reaction-diffusion model

At initial time T_1 , one has $\bar{u}(T_1, x) \geq \phi(x - X - B - C) + 2\delta \geq u(T_1, x)$ for all $x \geq X$. Moreover, for $t \geq T_1$ and $x = X$, since $\bar{\xi}(t, X) \leq -B - C < -C$, one deduces that $\bar{u}(t, X) \geq K_2 - \delta + 2\delta e^{-\delta(t-T_1)} + 2\delta \geq K_2 + \delta \geq u(t, X)$. Therefore, it remains to check that $\mathcal{N}\bar{u}(t, x) := \bar{u}_t(t, x) - d_2\bar{u}_{xx}(t, x) - f_2(\bar{u}(t, x)) \geq 0$ for all $t \geq T_1$ and $x \geq X$. After a straightforward computation, one derives

$$\mathcal{N}\bar{u}(t, x) = f_2(\phi(\bar{\xi}(t, x))) - f_2(\bar{u}(t, x)) - \phi'(\bar{\xi}(t, x))\omega\delta e^{-\delta(t-T_1)} - 2\delta^2 e^{-\delta(t-T_1)} - 2d_2\mu^2\delta e^{-\mu(x-X)}.$$

We distinguish three cases.

If $\bar{\xi}(t, x) \leq -C$, one has $K_2 - \delta \leq \phi(\bar{\xi}(t, x)) < K_2$. Hence, $\bar{u}(t, x) \geq K_2 - \delta$. It follows from (7.93) that $f_2(\phi(\bar{\xi}(t, x))) - f_2(\bar{u}(t, x)) \geq -(f_2'(K_2)/2)(2\delta e^{-\delta(t-T_1)} + 2\delta e^{-\mu(x-X)})$. It then can be deduced from (7.92)–(7.93) as well as the negativity of ϕ' and $f_2'(K_2)$ that

$$\begin{aligned} \mathcal{N}\bar{u}(t, x) &\geq -\frac{f_2'(K_2)}{2} \left(2\delta e^{-\delta(t-T_1)} + 2\delta e^{-\mu(x-X)} \right) - 2\delta^2 e^{-\delta(t-T_1)} - 2d_2\mu^2\delta e^{-\mu(x-X)} \\ &= \left(-\frac{f_2'(K_2)}{2} - \delta \right) 2\delta e^{-\delta(t-T_1)} + \left(-\frac{f_2'(K_2)}{2} - d_2\mu^2 \right) 2\delta e^{-\mu(x-X)} > 0. \end{aligned}$$

If $\bar{\xi}(t, x) \geq C$, one derives $0 < \phi(\bar{\xi}(t, x)) \leq \delta$ and then $\bar{u}(t, x) \leq 5\delta$. It follows from (7.93) that $f_2(\phi(\bar{\xi}(t, x))) - f_2(\bar{u}(t, x)) \geq -(f_2'(0)/2)(2\delta e^{-\delta(t-T_1)} + 2\delta e^{-\mu(x-X)})$. By virtue of (7.92)–(7.93) and the negativity of ϕ' and $f_2'(0)$, there holds

$$\begin{aligned} \mathcal{N}\bar{u}(t, x) &\geq -\frac{f_2'(0)}{2} \left(2\delta e^{-\delta(t-T_1)} + 2\delta e^{-\mu(x-X)} \right) - 2\delta^2 e^{-\delta(t-T_1)} - 2d_2\mu^2\delta e^{-\mu(x-X)} \\ &= \left(-\frac{f_2'(0)}{2} - \delta \right) 2\delta e^{-\delta(t-T_1)} + \left(-\frac{f_2'(0)}{2} - d_2\mu^2 \right) 2\delta e^{-\mu(x-X)} > 0. \end{aligned}$$

If $-C \leq \bar{\xi}(t, x) \leq C$, it turns out that $x - X \geq c_2(t - T_1) - \omega e^{-\delta(t-T_1)} + \omega + B \geq c_2(t - T_1) + B$, whence $e^{-\mu(x-X)} \leq e^{-\mu(c_2(t-T_1)+B)}$. By (7.93)–(7.96), one infers that

$$\begin{aligned} \mathcal{N}\bar{u}(t, x) &\geq -\max_{[0, K_2]} |f_2'| \left(2\delta e^{-\delta(t-T_1)} + 2\delta e^{-\mu(x-X)} \right) + \kappa\omega\delta e^{-\delta(t-T_1)} \\ &\quad - 2\delta^2 e^{-\delta(t-T_1)} - 2d_2\mu^2\delta e^{-\mu(x-X)} \\ &\geq \left(\kappa\omega - 2\delta - 2\max_{[0, K_2]} |f_2'| \right) \delta e^{-\delta(t-T_1)} - \left(\max_{[0, K_2]} |f_2'| + d_2\mu^2 \right) 2\delta e^{-\mu(c_2(t-T_1)+B)} \\ &\geq \left(\kappa\omega - 4\delta - 2\max_{[0, K_2]} |f_2'| \right) \delta e^{-\delta(t-T_1)} \geq 0. \end{aligned}$$

As a consequence, we have proved that $\mathcal{N}\bar{u}(t, x) := \bar{u}_t(t, x) - d_2\bar{u}_{xx}(t, x) - f_2(\bar{u}(t, x)) \geq 0$ for all $t \geq T_1$ and $x \geq X$. The comparison principle implies that

$$u(t, x) \leq \bar{u}(t, x) = \phi \left(x - X - c_2(t - T_1) + \omega e^{-\delta(t-T_1)} - \omega - B - C \right) + 2\delta e^{-\delta(t-T_1)} + 2\delta e^{-\mu(x-X)}$$

for all $t \geq T_1$ and $x \geq X$, whence (7.90) is achieved by taking $z_1 = -X - \omega - B - C$.

Step 2. Proof of (7.91). Since $p(x) \rightarrow K_2$ as $x \rightarrow +\infty$ by (7.88), it follows (up to increasing X if necessary) that $|p(x) - K_2| \leq \delta$ for all $x \geq X$. Moreover, since $\liminf_{t \rightarrow +\infty} u(t, \cdot) \geq p$ locally uniformly in $x \in \mathbb{R}$ by (7.87), one can choose $T_2 > 0$ so large that

$$u(t, x) \geq p(x) \geq K_2 - \delta \text{ for all } t \geq T_2, \text{ uniformly for } x \in [X, X + B + 2C]. \quad (7.99)$$

For $t \geq T_2$ and $x \geq X$, we set

$$\underline{u}(t, x) = \max \left(\phi(\underline{\xi}(t, x)) - \delta e^{-\delta(t-T_2)} - \delta e^{-\mu(x-X)}, 0 \right),$$

in which

$$\underline{\xi}(t, x) = x - X - c_2(t - T_2) - \omega e^{-\delta(t-T_2)} + \omega - B - C.$$

We shall check that $\underline{u}(t, x)$ is a subsolution to $u_t = d_2 u_{xx} + f_2(u)$ for all $t \geq T_2$ and $x \geq X$.

At the initial time $t = T_2$, one has $\underline{u}(T_2, x) \leq K_2 - \delta - \delta e^{-\mu(x-X)} \leq K_2 - \delta \leq u(T_2, x)$ for $X \leq x \leq X + B + 2C$ due to (7.99). For $x \geq X + B + 2C$, since $\underline{\xi}(T_2, x) \geq X + B + 2C - X - B - C = C$, one has $\phi(\underline{\xi}(T_2, x)) \leq \delta$. Thus, $\underline{u}(T_2, x) \leq \max(\delta - \delta - \delta e^{-\mu(x-X)}, 0) = 0 < u(T_2, x)$ for $x \geq X + B + 2C$. In conclusion, $\underline{u}(T_2, x) \leq u(T_2, x)$ for all $x \geq X$. At $x = X$, one sees that $\underline{u}(t, X) \leq K_2 - \delta e^{-\delta(t-T_2)} - \delta < u(t, X)$ for all $t \geq T_2$ owing to (7.99). It suffices to check that $\mathcal{N}\underline{u}(t, x) = \underline{u}_t(t, x) - d_2 \underline{u}_{xx}(t, x) - f_2(\underline{u}(t, x)) \leq 0$ for all $t \geq T_2$ and $x \geq X$ when $\underline{u}(t, x) > 0$. By a straightforward computation, one has

$$\mathcal{N}\underline{u}(t, x) = f_2(\phi(\underline{\xi}(t, x))) - f_2(\underline{u}(t, x)) + \phi'(\underline{\xi}(t, x))\omega\delta e^{-\delta(t-T_2)} + \delta^2 e^{-\delta(t-T_2)} + d_2 \mu^2 \delta e^{-\mu(x-X)}$$

By analogy to Step 1, we divide it into three cases.

If $\underline{\xi}(t, x) \leq -C$, then $K_2 - \delta \leq \phi(\underline{\xi}(t, x)) < K_2$ and thus $\underline{u}(t, x) \geq K_2 - 3\delta$. Thanks to (7.93), one has $f_2(\phi(\underline{\xi}(t, x))) - f_2(\underline{u}(t, x)) \leq (f_2'(K_2)/2)(\delta e^{-\delta(t-T_2)} + \delta e^{-\mu(x-X)})$. Therefore, by using (7.92)–(7.93) as well as the negativity of ϕ' and $f_2'(K_2)$, it comes that

$$\begin{aligned} \mathcal{N}\underline{u}(t, x) &< \frac{f_2'(K_2)}{2} \left(\delta e^{-\delta(t-T_2)} + \delta e^{-\mu(x-X)} \right) + \delta^2 e^{-\delta(t-T_2)} + d_2 \mu^2 \delta e^{-\mu(x-X)} \\ &= \left(\frac{f_2'(K_2)}{2} + \delta \right) \delta e^{-\delta(t-T_2)} + \left(\frac{f_2'(K_2)}{2} + d_2 \mu^2 \right) \delta e^{-\mu(x-X)} < 0. \end{aligned}$$

If $\underline{\xi}(t, x) \geq C$, then $\phi(\underline{\xi}(t, x)) \leq \delta$ and thus $\underline{u}(t, x) \leq \delta$. It follows from (7.93) that $f_2(\phi(\underline{\xi}(t, x))) - f_2(\underline{u}(t, x)) \leq (f_2'(0)/2)(\delta e^{-\delta(t-T_2)} + \delta e^{-\mu(x-X)})$. Therefore, owing to (7.92)–

7. Propagation and blocking in a two-patch reaction-diffusion model

(7.93) as well as the negativity of ϕ' and $f_2'(0)$, it follows that

$$\begin{aligned} \mathcal{N}\underline{u}(t, x) &< \frac{f_2'(0)}{2} \left(\delta e^{-\delta(t-T_2)} + \delta e^{-\mu(x-X)} \right) + \delta^2 e^{-\delta(t-T_2)} + d_2 \mu^2 \delta e^{-\mu(x-X)} \\ &= \left(\frac{f_2'(0)}{2} + \delta \right) \delta e^{-\delta(t-T_2)} + \left(\frac{f_2'(0)}{2} + d_2 \mu^2 \right) \delta e^{-\mu(x-X)} < 0. \end{aligned}$$

If $-C \leq \underline{\xi}(t, x) \leq C$, one has $x - X \geq c_2(t - T_2) + \omega e^{-\delta(t-T_2)} - \omega + B \geq c_2(t - T_2) - \omega + B$, whence $e^{-\mu(x-X)} \leq e^{-\mu(c_2(t-T_2)+B-\omega)}$. By (7.93)–(7.96), one infers that

$$\begin{aligned} \mathcal{N}\underline{u}(t, x) &\leq \max_{[0, K_2]} |f_2'| \left(\delta e^{-\delta(t-T_2)} + \delta e^{-\mu(x-X)} \right) - \kappa \omega \delta e^{-\delta(t-T_2)} \\ &\quad + \delta^2 e^{-\delta(t-T_2)} + d_2 \mu^2 \delta e^{-\mu(x-X)} \\ &\leq \left(\max_{[0, K_2]} |f_2'| - \kappa \omega + \delta \right) \delta e^{-\delta(t-T_2)} + \left(\max_{[0, K_2]} |f_2'| + d_2 \mu^2 \right) \delta e^{-\mu(c_2(t-T_2)+B-\omega)} \\ &\leq \left(\max_{[0, K_2]} |f_2'| - \kappa \omega + 2\delta \right) \delta e^{-\delta(t-T_2)} < 0. \end{aligned}$$

Consequently, one reaches $\mathcal{N}\underline{u}(t, x) := \underline{u}_t(t, x) - d_2 \underline{u}_{xx}(t, x) - f_2(\underline{u}(t, x)) \leq 0$ for all $t \geq T_2$ and $x \geq X$ when $\underline{u}(t, x) > 0$. By a comparison argument, one infers that

$$u(t, x) \geq \underline{u}(t, x) = \phi \left(x - X - c_2(t - T_2) - \omega e^{-\delta(t-T_2)} + \omega - B - C \right) - \delta e^{-\delta(t-T_2)} - \delta e^{-\mu(x-X)}$$

for all $t \geq T_2$ and $x \geq X$. Therefore, (7.91) is proved by taking $z_2 = -X - C$, since $B > \omega$ and ϕ is decreasing. \square

More generally, we have

Lemma 7.31. *Under the assumptions of Theorem 7.29, for any $\varepsilon > 0$, there exist $X_\varepsilon > 0$, $T_{1,\varepsilon} > 0$, $T_{2,\varepsilon} > 0$, $z_{1,\varepsilon} \in \mathbb{R}$ and $z_{2,\varepsilon} \in \mathbb{R}$ such that*

$$u(t, x) \leq \phi(x - c_2(t - T_{1,\varepsilon}) + z_{1,\varepsilon}) + 2\varepsilon e^{-\delta(t-T_{1,\varepsilon})} + 2\varepsilon e^{-\mu(x-X_\varepsilon)} \text{ for all } t \geq T_{1,\varepsilon} \text{ and } x \geq X_\varepsilon, \quad (7.100)$$

and

$$u(t, x) \geq \phi(x - c_2(t - T_{2,\varepsilon}) + z_{2,\varepsilon}) - \varepsilon e^{-\delta(t-T_{2,\varepsilon})} - \varepsilon e^{-\mu(x-X_\varepsilon)} \text{ for all } t \geq T_{2,\varepsilon} \text{ and } x \geq X_\varepsilon, \quad (7.101)$$

with the same parameters $\delta > 0$ and $\mu > 0$ as in Lemma 7.30.

Proof. Let μ and δ be defined as in (7.92) and (7.93). It is immediate to see from Lemma 7.30 that the result of Lemma 7.31 holds true with $X_\varepsilon = X$, $T_{1,\varepsilon} = T_1$, $T_{2,\varepsilon} = T_2$, $z_{1,\varepsilon} = z_1$ and $z_{2,\varepsilon} = z_2$, when $\varepsilon \geq \delta$. It remains to discuss the case $0 < \varepsilon < \delta$. For convenience, let us

introduce some parameters. Pick $C_\varepsilon \geq C > 0$ such that

$$\phi \geq K_2 - \varepsilon \text{ in } (-\infty, -C_\varepsilon], \quad \phi \leq \varepsilon \text{ in } [C_\varepsilon, +\infty).$$

Due to ϕ' is continuous and negative in \mathbb{R} , one can choose $\kappa > 0$ and then take $\omega > 0$ such that

$$\phi' \leq -\kappa \text{ in } [-C_\varepsilon, C_\varepsilon], \quad \kappa\omega \geq 4\delta + 2 \max_{[0, K_2]} |f_2'|. \quad (7.102)$$

Finally, let $B_\varepsilon > \tilde{\omega} := \varepsilon\omega/\delta$ be large enough such that

$$\left(\max_{[0, K_2]} |f_2'| + d_2\mu^2 \right) e^{-\mu(B_\varepsilon - \tilde{\omega})} \leq \delta.$$

Step 1. Proof of (7.100). Repeating the argument as that of (7.97)–(7.98) in Step 1 of Lemma 7.30 and replacing δ , X and T_1 there by ε , X_ε and $T_{1,\varepsilon}$, respectively, one then derives

$$u(t, X_\varepsilon) \leq K_2 + \varepsilon \text{ for all } t \geq T_{1,\varepsilon}.$$

$$u(T_{1,\varepsilon}, x) \leq \phi(x - X_\varepsilon - B_\varepsilon - C_\varepsilon) + 2\varepsilon \text{ for all } x \geq X_\varepsilon,$$

Define

$$\bar{u}(t, x) = \phi(\bar{\xi}(t, x)) + 2\varepsilon e^{-\delta(t-T_{1,\varepsilon})} + 2\varepsilon e^{-\mu(x-X_\varepsilon)} \text{ for } t \geq T_{1,\varepsilon} \text{ and } x \geq X_\varepsilon,$$

where

$$\bar{\xi}(t, x) = x - X_\varepsilon - c_2(t - T_{1,\varepsilon}) + \tilde{\omega} e^{-\delta(t-T_{1,\varepsilon})} - \tilde{\omega} - B_\varepsilon - C_\varepsilon.$$

Following the same lines as in Step 1 of Lemma 7.30, it can be deduced that $\bar{u}(t, x)$ is a supersolution to $u_t = d_2 u_{xx} + f_2(u)$ for all $t \geq T_{1,\varepsilon}$ and $x \geq X_\varepsilon$, whence

$$u(t, x) \leq \phi(x - X_\varepsilon - c_2(t - T_{1,\varepsilon}) + \tilde{\omega} e^{-\delta(t-T_{1,\varepsilon})} - \tilde{\omega} - B_\varepsilon - C_\varepsilon) + 2\varepsilon e^{-\delta(t-T_{1,\varepsilon})} + 2\varepsilon e^{-\mu(x-X_\varepsilon)}.$$

Consequently, (7.100) is proved by choosing $z_{1,\varepsilon} = -X_\varepsilon - \tilde{\omega} - B_\varepsilon - C_\varepsilon$.

Step 2. Proof of (7.101). Using the same argument as that of (7.99) with δ , X and T_2 replaced by ε , X_ε and $T_{2,\varepsilon}$, then one has

$$u(t, x) \geq K_2 - \varepsilon \text{ for all } t \geq T_{2,\varepsilon}, \text{ uniformly in } x \in [X_\varepsilon, X_\varepsilon + B_\varepsilon + 2C_\varepsilon].$$

Then we set

$$\underline{u}(t, x) = \max(\phi(\underline{\xi}(t, x)) - \varepsilon e^{-\delta(t-T_{2,\varepsilon})} - \varepsilon e^{-\mu(x-X_\varepsilon)}, 0) \text{ for } t \geq T_{2,\varepsilon} \text{ and } x \geq X_\varepsilon,$$

7. Propagation and blocking in a two-patch reaction-diffusion model

in which

$$\underline{\xi}(t, x) = x - X_\varepsilon - c_2(t - T_{2,\varepsilon}) - \tilde{\omega}e^{-\delta(t-T_{2,\varepsilon})} + \tilde{\omega} - B_\varepsilon - C_\varepsilon.$$

One can follow the proof of (7.91) to show that $\underline{u}(t, x)$ is a subsolution of $u_t = d_2u_{xx} + f_2(u)$ for all $t \geq T_{2,\varepsilon}$ and $x \geq X_\varepsilon$. By the comparison principle, one derives

$$u(t, x) \geq \phi(x - X_\varepsilon - c_2(t - T_{2,\varepsilon}) - \tilde{\omega}e^{-\delta(t-T_{2,\varepsilon})} + \tilde{\omega} - B_\varepsilon - C_\varepsilon) - \varepsilon e^{-\delta(t-T_{2,\varepsilon})} - \varepsilon e^{-\mu(x-X_\varepsilon)}$$

for all $t \geq T_{2,\varepsilon}$ and $x \geq X_\varepsilon$. Then (7.101) follows by taking $z_{2,\varepsilon} = -X_\varepsilon - C_\varepsilon$, since $B_\varepsilon > \tilde{\omega}$ and $\phi' < 0$. \square

Remark 7.32. By contrast with Lemma 7.30, one can observe that the quantity $z_{1,\varepsilon} = -X_\varepsilon - \varepsilon\omega/\delta - B_\varepsilon - C_\varepsilon$ in the upper bound (7.100) may not be bounded from below independently of ε and therefore may not be replaced with a quantity independent of ε .

Next, we provide the stability result of the bistable traveling front in a half line.

Lemma 7.33. *Assume that (7.10)–(7.11) hold and that $\int_0^{K_2} f_2(s)ds > 0$. There exists $\tilde{M} > 0$ such that if there are $\varepsilon > 0$, $t_0 > 0$, $x_0 > 0$ and $\xi \in \mathbb{R}$ such that*

$$\sup_{x \geq x_0} |u(t_0, x) - \phi(x - c_2t_0 + \xi)| \leq \varepsilon, \quad (7.103)$$

$K_2 - \varepsilon \leq u(t, x_0) \leq K_2 + \varepsilon$ for all $t \geq t_0$, $\phi(x_0 - c_2t_0 + \xi) \geq K_2 - \varepsilon$ and

$$\left(\max_{[0, K_2]} |f_2'| + d_2\mu^2 \right) e^{-\mu(c_2t_0 - x_0 - \tilde{\omega} - \xi - C_\varepsilon)} < \delta \quad (7.104)$$

where $\mu > 0$, $\delta > 0$, $\omega > 0$ and $C_\varepsilon > 0$ are defined as in Lemma 7.31 and $\tilde{\omega} = \varepsilon\omega/\delta$, then there holds

$$\sup_{x \geq x_0} |u(t, x) - \phi(x - c_2t + \xi)| \leq \tilde{M}\varepsilon \text{ for all } t \geq t_0.$$

Proof. Let ε , t_0 , x_0 , ξ , μ , δ , ω , $\tilde{\omega}$ and C_ε be as in the statement. Let $\kappa > 0$ be defined as in (7.102). We claim that

$$\bar{u}(t, x) = \phi(x - c_2t + \tilde{\omega}e^{-\delta(t-t_0)} - \tilde{\omega} + \xi) + 2\varepsilon e^{-\delta(t-t_0)} + 2\varepsilon e^{-\mu(x-x_0)}$$

and

$$\underline{u}(t, x) = \max(\phi(x - c_2t - \tilde{\omega}e^{-\delta(t-t_0)} + \tilde{\omega} + \xi) - \varepsilon e^{-\delta(t-t_0)} - \varepsilon e^{-\mu(x-x_0)}, 0)$$

are, respectively, a super- and a sub-solution of $u_t = d_2u_{xx} + f_2(u)$ for all $t \geq t_0$ and $x \geq x_0$. We just check that $\underline{u}(t, x)$ is a subsolution in detail and the supersolution can be proved in a similar way.

At the initial time $t = t_0$, one has $\underline{u}(t_0, x) \leq \phi(x - c_2t_0 + \xi) - \varepsilon - \varepsilon e^{-\mu(x-x_0)} \leq u(t_0, x)$ for all $x \geq x_0$ thanks to (7.103). Moreover, $\underline{u}(t, x_0) = \max(\phi(x_0 - c_2t - \tilde{\omega}e^{-\delta(t-t_0)} + \tilde{\omega} + \xi) -$

$\varepsilon e^{-\delta(t-t_0)} - \varepsilon, 0) \leq K_2 - \varepsilon \leq u(t, x_0)$ for $t \geq t_0$, owing to the assumption on $u(t, x_0)$. It then remains to show that $\mathcal{N}\underline{u}(t, x) = \underline{u}_t(t, x) - d_2 \underline{u}_{xx}(t, x) - f_2(\underline{u}(t, x)) \leq 0$ for all $t \geq t_0$ and $x \geq x_0$ when $\underline{u}(t, x) > 0$.

For convenience, we set $\underline{\xi}(t, x) := x - c_2 t - \tilde{\omega} e^{-\delta(t-t_0)} + \tilde{\omega} + \xi$. By a straightforward computation, one has

$$\mathcal{N}\underline{u}(t, x) = f_2(\phi(\underline{\xi}(t, x))) - f_2(\underline{u}(t, x)) + \phi'(\underline{\xi}(t, x))\tilde{\omega}\delta e^{-\delta(t-t_0)} + \varepsilon\delta e^{-\delta(t-t_0)} + d_2\mu^2\varepsilon e^{-\mu(x-x_0)}.$$

There are three cases.

If $\underline{\xi}(t, x) \leq -C_\varepsilon$, then $K_2 - \varepsilon \leq \phi(\underline{\xi}(t, x)) < K_2$ and thus $\underline{u}(t, x) \geq K_2 - 3\varepsilon$. Therefore, by using (7.92)–(7.93) as well as the negativity of ϕ' and $f_2'(K_2)$, it follows that

$$\begin{aligned} \mathcal{N}\underline{u}(t, x) &\leq \frac{f_2'(K_2)}{2} \left(\varepsilon e^{-\delta(t-t_0)} + \varepsilon e^{-\mu(x-x_0)} \right) + \varepsilon\delta e^{-\delta(t-t_0)} + d_2\mu^2\varepsilon e^{-\mu(x-x_0)} \\ &= \left(\frac{f_2'(K_2)}{2} + \delta \right) \varepsilon e^{-\delta(t-t_0)} + \left(\frac{f_2'(K_2)}{2} + d_2\mu^2 \right) \varepsilon e^{-\mu(x-x_0)} \leq 0. \end{aligned}$$

If $-C_\varepsilon \leq \underline{\xi}(t, x) \leq C_\varepsilon$, one has $x - x_0 \geq c_2(t - t_0) + c_2 t_0 - x_0 + \tilde{\omega} e^{-\delta(t-t_0)} - \tilde{\omega} - \xi - C_\varepsilon \geq c_2(t - t_0) + c_2 t_0 - x_0 - \tilde{\omega} - \xi - C_\varepsilon$. Hence, $e^{-\mu(x-x_0)} \leq e^{-\mu(c_2(t-t_0) + c_2 t_0 - x_0 - \tilde{\omega} - \xi - C_\varepsilon)}$. One infers from (7.102) as well as (7.104) that

$$\begin{aligned} \mathcal{N}\underline{u}(t, x) &\leq \max_{[0, K_2]} |f_2'| \left(\varepsilon e^{-\delta(t-t_0)} + \varepsilon e^{-\mu(x-x_0)} \right) - \kappa\tilde{\omega}\delta e^{-\delta(t-t_0)} \\ &\quad + \varepsilon\delta e^{-\delta(t-t_0)} + d_2\mu^2\varepsilon e^{-\mu(x-x_0)} \\ &\leq \left(\max_{[0, K_2]} |f_2'| - \kappa\omega + \delta \right) \varepsilon e^{-\delta(t-t_0)} + \left(\max_{[0, K_2]} |f_2'| + d_2\mu^2 \right) \varepsilon e^{-\mu(c_2(t-t_0) + c_2 t_0 - x_0 - \tilde{\omega} - \xi - C_\varepsilon)} \\ &\leq \left(\max_{[0, K_2]} |f_2'| - \kappa\omega + 2\delta \right) \varepsilon e^{-\delta(t-t_0)} \leq 0. \end{aligned}$$

Finally, if $\underline{\xi}(t, x) \geq C_\varepsilon$, then $\phi(\underline{\xi}(t, x)) \leq \varepsilon$ and thus $\underline{u}(t, x) \leq \varepsilon$. Therefore, owing to (7.92)–(7.93) as well as the negativity of ϕ' and $f_2'(0)$, it follows that

$$\begin{aligned} \mathcal{N}\underline{u}(t, x) &\leq \frac{f_2'(0)}{2} \left(\varepsilon e^{-\delta(t-t_0)} + \varepsilon e^{-\mu(x-x_0)} \right) + \varepsilon\delta e^{-\delta(t-t_0)} + d_2\mu^2\varepsilon e^{-\mu(x-x_0)} \\ &= \left(\frac{f_2'(0)}{2} + \delta \right) \varepsilon e^{-\delta(t-t_0)} + \left(\frac{f_2'(0)}{2} + d_2\mu^2 \right) \varepsilon e^{-\mu(x-x_0)} \leq 0. \end{aligned}$$

Eventually, one concludes that $\mathcal{N}\underline{u}(t, x) := \underline{u}_t(t, x) - d_2 \underline{u}_{xx}(t, x) - f_2(\underline{u}(t, x)) \leq 0$ for all $t \geq t_0$ and $x \geq x_0$ when $\underline{u}(t, x) > 0$. By a comparison argument, one infers that

$$u(t, x) \geq \phi(x - c_2 t - \tilde{\omega} e^{-\delta(t-t_0)} + \tilde{\omega} + \xi) - \varepsilon e^{-\delta(t-t_0)} - \varepsilon e^{-\mu(x-x_0)}$$

7. Propagation and blocking in a two-patch reaction-diffusion model

for all $t \geq t_0$ and $x \geq x_0$. For these t and x , since $\phi' < 0$, one derives that

$$u(t, x) \geq \phi(x - c_2 t + \tilde{\omega} + \xi) - 2\varepsilon \geq \phi(x - c_2 t + \xi) - \tilde{\omega} \|\phi'\|_{L^\infty(\mathbb{R})} - 2\varepsilon$$

Similarly, one also deduces from $u(t, x) \leq \phi(x - c_2 t + \tilde{\omega} e^{-\delta(t-t_0)} - \tilde{\omega} + \xi) + 2\varepsilon e^{-\delta(t-t_0)} + 2\varepsilon e^{-\mu(x-x_0)}$ for all $t \geq t_0$ and $x \geq x_0$ that

$$u(t, x) \leq \phi(x - c_2 t - \tilde{\omega} + \xi) + 4\varepsilon \leq \phi(x - c_2 t + \xi) + \tilde{\omega} \|\phi'\|_{L^\infty(\mathbb{R})} + 4\varepsilon$$

In conclusion, one has

$$\sup_{x \geq x_0} |u(t, x) - \phi(x - ct + \xi)| \leq \tilde{\omega} \|\phi'\|_{L^\infty(\mathbb{R})} + 4\varepsilon = \tilde{M}\varepsilon \text{ for all } t \geq t_0,$$

where $\tilde{M} := \omega \|\phi'\|_{L^\infty(\mathbb{R})} / \delta + 4$ is independent of ε , t_0 , x_0 and ξ . \square

Now we are in a position to complete the proof of Theorem 7.29.

Proof of Theorem 7.29 (continued). Let $X > 0$, $T_1 > 0$, $T_2 > 0$, $z_1 \in \mathbb{R}$, $z_2 \in \mathbb{R}$, $\mu > 0$ and $\delta > 0$ be as in Lemma 7.30. For $t \geq \max(T_1, T_2)$ and $x \geq X$, there holds

$$\begin{aligned} \phi(x - c_2(t - T_2) + z_2) - \delta e^{-\delta(t-T_2)} - \delta e^{-\mu(x-X)} &\leq u(t, x) \\ &\leq \phi(x - c_2(t - T_1) + z_1) + 2\delta e^{-\delta(t-T_1)} + 2\delta e^{-\mu(x-X)}. \end{aligned} \quad (7.105)$$

Consider any sequence $(t_n)_{n \in \mathbb{N}}$ such that $t_n \rightarrow +\infty$ as $n \rightarrow +\infty$. By standard parabolic estimates, up to some subsequence, the functions $u_n(t, y) := u(t + t_n, y + c_2 t_n)$ defined on $\mathbb{R} \times \mathbb{R}$ converge as $n \rightarrow +\infty$, locally uniformly in $(t, y) \in \mathbb{R} \times \mathbb{R}$, to a classical solution u_∞ of $(u_\infty)_t = d_2(u_\infty)_{yy} + f_2(u_\infty)$ for $(t, y) \in \mathbb{R} \times \mathbb{R}$.

By virtue of (7.105), passing to the limit $n \rightarrow +\infty$ gives that

$$\phi(y - c_2(t - T_2) + z_2) \leq u_\infty(t, y) \leq \phi(y - c_2(t - T_1) + z_1) \text{ for all } (t, y) \in \mathbb{R} \times \mathbb{R}.$$

Then, [18, Theorem 3.1] implies that, there exists $\xi \in \mathbb{R}$ such that $u_\infty(t, y) = \phi(y - c_2 t + \xi)$ for all $(t, y) \in \mathbb{R} \times \mathbb{R}$, whence

$$u_n(t, y) \rightarrow \phi(y - c_2 t + \xi) \text{ as } n \rightarrow +\infty, \text{ locally uniformly in } (t, y) \in \mathbb{R} \times \mathbb{R}. \quad (7.106)$$

For any $\varepsilon > 0$, let $C_\varepsilon > 0$ be such that $\phi \geq K_2 - \varepsilon/2$ in $(-\infty, -C_\varepsilon]$ and $\phi \leq \varepsilon/2$ in $[C_\varepsilon, +\infty)$. Set $E_1 := \max(C_\varepsilon - c_2 T_1 - z_1, C_\varepsilon - \xi)$ and $E_2 := \min(-C_\varepsilon - c_2 T_2 - z_2, -C_\varepsilon - \xi) < E_1$. Then, it can be deduced from (7.106) that

$$\sup_{E_2 \leq y \leq E_1} |u_n(0, y) - \phi(y + \xi)| \leq \varepsilon \text{ for all } n \text{ large enough.} \quad (7.107)$$

Since $t_n \rightarrow +\infty$ as $n \rightarrow +\infty$, (7.105) implies that, for n large enough,

$$\begin{cases} 0 < u_n(0, y) \leq \varepsilon & \text{for } y \geq E_1, \\ K_2 - \varepsilon \leq u_n(0, y) \leq K_2 + \varepsilon & \text{for } E_2 - \frac{c_2}{2}t_n \leq y \leq E_2. \end{cases} \quad (7.108)$$

On the other hand, since $E_1 \geq C_\varepsilon - \xi$ and $E_2 \leq -C_\varepsilon - \xi$, one has

$$\begin{cases} 0 < \phi(y + \xi) \leq \varepsilon/2 < \varepsilon & \text{for } y \geq E_1, \\ K_2 - \varepsilon < K_2 - \varepsilon/2 \leq \phi(y + \xi) < K_2 & \text{for } y \leq E_2. \end{cases} \quad (7.109)$$

Then (7.108)–(7.109) imply that, for n large enough,

$$|u_n(0, y) - \phi(y + \xi)| \leq 2\varepsilon \text{ for } y \geq E_1 \text{ or } E_2 - \frac{c_2}{2}t_n \leq y \leq E_2.$$

Together with (7.107) and the definition of $u_n(t, y)$, one has, for n large enough,

$$|u(t_n, x) - \phi(x - c_2t_n + \xi)| \leq 2\varepsilon \text{ for all } x \geq E_2 + \frac{c_2}{2}t_n. \quad (7.110)$$

On the other hand, one infers from Lemma 7.31 that, for n large enough,

$$\begin{aligned} K_2 - 3\varepsilon &\leq \phi(x - c_2(t_n - T_{2,\varepsilon}) + z_{2,\varepsilon}) - \varepsilon e^{-\delta(t_n - T_{2,\varepsilon})} - \varepsilon e^{-\mu(x - X_\varepsilon)} \leq u(t_n, x) \\ &\leq \phi(x - c_2(t_n - T_{1,\varepsilon}) + z_{1,\varepsilon}) + 2\varepsilon e^{-\delta(t_n - T_{1,\varepsilon})} + 2\varepsilon e^{-\mu(x - X_\varepsilon)} \leq K_2 + 4\varepsilon, \end{aligned} \quad (7.111)$$

for all $\max(X, X_\varepsilon) \leq x \leq E_2 + c_2t_n/2$, where $X_\varepsilon > 0$, $T_{1,\varepsilon} > 0$, $T_{2,\varepsilon} > 0$, $z_{1,\varepsilon} \in \mathbb{R}$ and $z_{2,\varepsilon} \in \mathbb{R}$ were given in Lemma 7.31.

Notice also that, for n large enough,

$$K_2 - \varepsilon < K_2 - \frac{\varepsilon}{2} \leq \phi(x - c_2t_n + \xi) < K_2 \text{ for all } \max(X, X_\varepsilon) \leq x \leq E_2 + \frac{c_2}{2}t_n. \quad (7.112)$$

From (7.111)–(7.112) one deduces that, for n large enough,

$$|u(t_n, x) - \phi(x - c_2t_n + \xi)| \leq 5\varepsilon \text{ for all } \max(X, X_\varepsilon) \leq x \leq E_2 + \frac{c_2}{2}t_n.$$

Together with (7.110), one derives that, for n large enough,

$$|u(t_n, x) - \phi(x - c_2t_n + \xi)| \leq 5\varepsilon \text{ for all } x \geq \max(X, X_\varepsilon).$$

Furthermore, due to (7.87)–(7.89), there is $x_\varepsilon \geq \max(X, X_\varepsilon)$ such that, for n large enough,

$$K_2 - 5\varepsilon \leq u(t, x_\varepsilon) \leq K_2 + 5\varepsilon \text{ for all } t \geq t_n,$$

7. Propagation and blocking in a two-patch reaction-diffusion model

and

$$\phi(x_\varepsilon - c_2 t_n + \xi) \geq K_2 - \varepsilon, \quad \left(\max_{[0, K_2]} |f'_2| + d_2 \mu^2 \right) e^{-\mu(c_2 t_n - x_\varepsilon - \varepsilon \omega / \delta - \xi - C_\varepsilon)} < \delta.$$

It then follows from Lemma 7.33 that, for n large enough,

$$|u(t, x) - \phi(x - c_2 t + \xi)| \leq 5\widetilde{M}\varepsilon \text{ for all } t \geq t_n \text{ and } x \geq x_\varepsilon,$$

with \widetilde{M} given in Lemma 7.33. Since $\varepsilon > 0$ is arbitrary, $t_n \rightarrow +\infty$ as $n \rightarrow +\infty$ and $x_\varepsilon \rightarrow +\infty$ as $\varepsilon \rightarrow 0$, taking $n \rightarrow +\infty$ and $\varepsilon \rightarrow 0$, one infers that

$$\sup_{t \geq A, x \geq A} |u(t, x) - \phi(x - c_2 t + \xi)| \rightarrow 0 \text{ as } A \rightarrow +\infty.$$

This completes the proof of Theorem 7.29. □

Finally, we are in a position to prove Theorem 7.16.

Proof of Theorem 7.16. For any $\eta > 0$ and for some $L > 0$ (will be fixed later), let $x_L > L > 0$ and denote by u_L the solution of the Cauchy problem (7.3) with initial condition

$$u_L(0, \cdot) = \begin{cases} \theta + \eta & \text{in } [x_L - L, x_L + L], \\ 0 & \text{otherwise.} \end{cases}$$

It follows from local parabolic estimates that

$$u_L(t, x) \rightarrow \zeta(t) \text{ as } L \rightarrow +\infty \text{ locally in } t \geq 0, \text{ uniformly in } x \in \mathcal{K}_L, \quad (7.113)$$

where ζ is the solution of the ODE $\zeta'(t) = f_2(\zeta(t))$ for $t > 0$ with initial condition $\zeta(0) = \theta + \eta$, and \mathcal{K}_L represents any compact interval containing x_L . Since $\zeta(t) \nearrow K_2$ as $t \rightarrow +\infty$, it follows that for any $\varepsilon > 0$, there is $T > 0$ such that $\zeta(T) \geq \psi(0) + \varepsilon$, where $\psi(x)$ was given by (7.86) defined in $[-R, R]$ for some $R > 0$. By (7.113), one can then pick $L > R$ sufficiently large such that

$$u_L(T, \cdot) > \zeta(T) - \varepsilon \geq \psi(0) \text{ in } [x_L - R, x_L + R].$$

Let u be the solution to (7.3) with nonnegative continuous and compactly supported initial function $u_0 \not\equiv 0$ satisfying $u_0(\cdot) \geq \theta + \eta$ on an interval of size L included in patch 2, say $[x_L - L, x_L + L]$ for some $x_L > L > 0$. The comparison principle then gives that

$$u(T, \cdot) \geq u_L(T, \cdot) > \psi(0) \text{ in } [x_L - R, x_L + R].$$

Then, following similar argument to that of Theorem 7.29, one can derive the desired conclusion. □

Proof of Theorem 7.17. Let u be the solution to the Cauchy problem (7.3) with nonnegative continuous and compactly supported initial value $u_0 \not\equiv 0$. Proposition 7.4 gives that $0 < u(t, x) < M := \max(K_1, K_2, \|u_0\|_{L^\infty(\mathbb{R})})$ for $t > 0$ and $x \in \mathbb{R}$.

Let v and w be as in the beginning of the proof of Theorem 7.8, namely, v represents the solution to the Cauchy problem (7.3) with initial value $v(0, \cdot) = \varepsilon\psi(\cdot - x_0) < u(1, \cdot)$ in \mathbb{R} for $\varepsilon > 0$ small enough and for $x_0 \leq -R$, where R and ψ are given as in (7.43)–(7.44), and w denotes the solution to (7.3) with initial value $w(0, \cdot) = M$ in \mathbb{R} . Proposition 7.4 implies that $0 < v(t, x) < u(t+1, x) < w(t+1, x) \leq M$ for $t > 0$ and $x \in \mathbb{R}$. Moreover, v is increasing with respect to t and w is nonincreasing in t . From parabolic estimates, $v(t, \cdot)$ and $w(t, \cdot)$ converge as $t \rightarrow +\infty$, locally uniformly in \mathbb{R} , to stationary solutions p and q of (7.3), respectively. Moreover, there holds

$$0 < p \leq \liminf_{t \rightarrow +\infty} u(t, \cdot) \leq \limsup_{t \rightarrow +\infty} u(t, \cdot) \leq q \leq M, \quad (7.114)$$

locally uniformly in \mathbb{R} . From the proof of Theorem 7.8, it is seen that $p(-\infty) = q(-\infty) = K_1$.

In the following, we wish to show that $p = q$ in \mathbb{R} and $p(+\infty) = q(+\infty) = K_2$. For this purpose, let us first prove that p is stable in $\overline{\mathbb{R}}_+$ in the sense that

$$\int_0^{+\infty} d_2 |\varphi'|^2 - f_2'(p)\varphi^2 \geq 0, \quad (7.115)$$

for every $\varphi \in C^1(\overline{\mathbb{R}}_+)$ with compact support. In fact, we first notice that the function v satisfies

$$0 \leq v_t = d_2(v-p)_{xx} + f_2(v) - f_2(p) \text{ for } t > 0 \text{ and } x > 0.$$

For any given $C^1(\overline{\mathbb{R}}_+)$ function φ with compact support, multiplying the above equation by the nonnegative function $\varphi^2/(p-v(t, \cdot))$ and integrating over \mathbb{R}_+ at each fixed $t > 0$ gives that

$$\begin{aligned} 0 &\leq \int_0^{+\infty} d_2(p-v(t, \cdot))' \left(\frac{\varphi^2}{(p-v(t, \cdot))} \right)' - \frac{f_2(v(t, \cdot)) - f_2(p)}{v(t, \cdot) - p} \varphi^2 \\ &= \int_0^{+\infty} d_2 \left(2 \frac{\varphi(p-v(t, \cdot))' \varphi'}{p-v(t, \cdot)} - \frac{|(p-v(t, \cdot))'|^2 \varphi^2}{(p-v(t, \cdot))^2} \right) - \frac{f_2(v(t, \cdot)) - f_2(p)}{v(t, \cdot) - p} \varphi^2 \\ &\leq \int_0^{+\infty} d_2 |\varphi'|^2 - \frac{f_2(v(t, \cdot)) - f_2(p)}{v(t, \cdot) - p} \varphi^2. \end{aligned}$$

Since $v(t, \cdot) \rightarrow p$ as $t \rightarrow +\infty$ locally uniformly in \mathbb{R} , passing to the limit $t \rightarrow +\infty$ yields (7.115).

Next, we show that $p(+\infty) = K_2$. If there is $x_0 \in [0, +\infty)$ such that $p(x_0) = K_2$, the Cauchy-Lipschitz theorem then implies $p \equiv K_2$ in $[0, +\infty)$ and $p'(0) = 0$, whence $p \equiv K_1$ in $(-\infty, 0]$. This is true if and only if $K_1 = K_2$, i.e. $p \equiv K_1 = K_2$ in \mathbb{R} . In the sequel, we

7. Propagation and blocking in a two-patch reaction-diffusion model

consider the case that $p(\cdot) - K_2$ has a strict constant sign in $\overline{\mathbb{R}}_+$. Assume first that p has at least two critical points $0 \leq a < b < +\infty$ such that $p'(a) = p'(b) = 0$. By reflection, set $z_1 := p(2b - \cdot)$ in $[b, 2b - a]$, then z_1 satisfies

$$\begin{cases} d_2 z_1'' + f_2(z_1) = 0, & \text{in } [b, 2b - a], \\ z_1(b) = p(b), \quad z_1'(b) = p'(b) = 0. \end{cases}$$

The Cauchy-Lipschitz theorem implies that $z_1 = p$ in $[b, 2b - a]$. Thus, $p(2b - a) = p(a)$ and $p'(2b - a) = 0$. Again using reflection, we set $z_2 := p(4b - 2a - \cdot)$ in $[2b - a, 4b - 3a]$ and apply the Cauchy-Lipschitz theorem, it follows that $z_2 = p$ in $[2b - a, 4b - 3a]$. Repeating above procedures gives that p is periodic in $[a, +\infty)$. This is impossible since p is stable in $\overline{\mathbb{R}}_+$. Therefore, p has at most one critical point in $\overline{\mathbb{R}}_+$. This implies that p is strictly monotone in, say, $[R, +\infty)$ for some $R > 0$ large. Recall that $0 < p < M$, then $p(+\infty)$ exists. Since p is stable and since there is no stationary solution U of (7.3) connecting K_1 and 0, it follows that $p(+\infty) = K_2$.

Similarly, one can also show that q is stable in $\overline{\mathbb{R}}_+$ and $q(+\infty) = K_2$. Indeed, we first observe that

$$0 \leq -w_t = d_2(q - w)_{xx} + f_2(q) - f_2(w), \quad t > 0, \quad x \in \mathbb{R}_+.$$

Consider again any $C^1(\overline{\mathbb{R}}_+)$ function φ with compact support. Multiplying the above equation by the nonnegative function $\varphi^2/(w(t, \cdot) - q)$ and integrating by parts over \mathbb{R}_+ at each fixed time $t > 0$ yields that

$$\begin{aligned} 0 &\leq \int_0^{+\infty} d_2(w(t, \cdot) - q)' \left(\frac{\varphi^2}{w(t, \cdot) - q} \right)' - \frac{f_2(w(t, \cdot)) - f_2(q)}{w(t, \cdot) - q} \varphi^2 \\ &= \int_0^{+\infty} d_2 \left(2 \frac{\varphi(w(t, \cdot) - q)' \varphi'}{w(t, \cdot) - q} - \frac{|(w(t, \cdot) - q)'|^2 \varphi^2}{(w(t, \cdot) - q)^2} \right) - \frac{f_2(w(t, \cdot)) - f_2(q)}{w(t, \cdot) - q} \varphi^2 \\ &\leq \int_0^{K_2} d_2 |\varphi'|^2 - \frac{f_2(w(t, \cdot)) - f_2(q)}{w(t, \cdot) - q} \varphi^2. \end{aligned}$$

Since $w(t, \cdot) \rightarrow q$ as $t \rightarrow +\infty$, locally uniformly in \mathbb{R} , passing to the limit $t \rightarrow +\infty$ implies

$$0 \leq \int_0^{+\infty} d_2 |\varphi'|^2 - f_2'(q) \varphi^2.$$

Therefore, q is stable in $\overline{\mathbb{R}}_+$. Moreover, following the same lines as in the proof of $p(+\infty) = K_2$ above, one can rule out the case that q is periodic far to the right in patch 2. Thus, q has at most one critical point in patch 2 and whence q has to be monotone in, say, $[R, +\infty)$ for some $R > 0$ large. Therefore, $q(+\infty)$ exists. This implies $q(+\infty)$ can only be K_2 or 0, due to the stability of q in $\overline{\mathbb{R}}_+$. Since $q \geq p$ in \mathbb{R} and $p(+\infty) = K_2$, one has $q(+\infty) = K_2$ and

therefore $q = p$ in \mathbb{R} by the uniqueness of the stationary solution of (7.3) connecting K_1 and K_2 shown in Proposition 7.12. The desired conclusion (7.17) is therefore achieved, due to (7.114).

By using (7.17), the property (i) can be derived from Theorem 7.16 by a comparison argument. It remains to prove property (ii). Assume now that $\int_0^{K_2} f_2(s)ds = 0$. For any $\varepsilon > 0$, let $f_{2,\varepsilon}$ be of class $C^1(\overline{\mathbb{R}_+})$ such that

$$\begin{aligned} f_{2,\varepsilon}(0) = f_{2,\varepsilon}(\theta) = f_{2,\varepsilon}(K_2 + \varepsilon) = 0, \quad f'_{2,\varepsilon}(0) < 0, \quad f'_{2,\varepsilon}(K_2 + \varepsilon) < 0, \\ f_{2,\varepsilon} = f_2 < 0 \text{ in } (0, \theta), \quad f_{2,\varepsilon} > 0 \text{ in } (\theta, K_2 + \varepsilon), \quad f_{2,\varepsilon} < 0 \text{ in } (K_2 + \varepsilon, +\infty). \end{aligned}$$

It is also assumed that $f_{2,\varepsilon} \geq f_2$ in $(\theta, +\infty)$. We observe that $\int_0^{K_2+\varepsilon} f_{2,\varepsilon}(s)ds > 0$. Let ϕ_ε be the unique traveling wave of $u_t = d_2 u_{xx} + f_{2,\varepsilon}(u)$ such that

$$d_2 \phi_\varepsilon'' + c_{2,\varepsilon} \phi_\varepsilon' + f_{2,\varepsilon}(\phi_\varepsilon) = 0, \quad \phi_\varepsilon' < 0 \text{ in } \mathbb{R}, \quad \phi_\varepsilon(0) = \theta, \quad \phi_\varepsilon(-\infty) = K_2 + \varepsilon, \quad \phi_\varepsilon(+\infty) = 0,$$

with speed $c_{2,\varepsilon} > 0$. It is seen that $\phi_\varepsilon \rightarrow \phi$ and $c_{2,\varepsilon} \rightarrow 0$ as $\varepsilon \rightarrow 0$.

Let us introduce some parameters. Choose $\mu > 0$ such that

$$0 < \mu < \sqrt{\min\left(\frac{|f'_{2,\varepsilon}(0)|}{2d_2}, \frac{|f'_{2,\varepsilon}(K_2 + \varepsilon)|}{2d_2}\right)}. \quad (7.116)$$

Then we take $\varepsilon > 0$ such that (we notice that $c_{2,\varepsilon} > 0$)

$$\begin{aligned} 0 < \varepsilon < \min\left(\mu c_{2,\varepsilon}, \frac{\theta}{5}, \frac{K_2 + \varepsilon - \theta}{5}, \frac{|f'_{2,\varepsilon}(0)|}{2}, \frac{|f'_{2,\varepsilon}(K_2 + \varepsilon)|}{2}\right), \\ f'_{2,\varepsilon} \leq \frac{f'_{2,\varepsilon}(0)}{2} \text{ in } [0, 5\varepsilon], \quad f'_{2,\varepsilon} \leq \frac{f'_{2,\varepsilon}(K_2 + \varepsilon)}{2} \text{ in } [K_2 - 5\varepsilon, +\infty). \end{aligned} \quad (7.117)$$

Let $C > 0$ be such that

$$\phi_\varepsilon \geq K_2 - \varepsilon \text{ in } (-\infty, -C], \quad \phi_\varepsilon \leq \varepsilon \text{ in } [C, +\infty).$$

Since $\phi_\varepsilon' < 0$ is continuous in \mathbb{R} , there is $\kappa > 0$ such that

$$-\phi_\varepsilon' \geq \kappa > 0 \text{ in } [-C, C], \quad (7.118)$$

and then take $\omega > 0$ so that

$$\kappa\omega \geq 4\varepsilon + 2 \max_{[0, K_2 + \varepsilon]} |f'_{2,\varepsilon}|. \quad (7.119)$$

7. Propagation and blocking in a two-patch reaction-diffusion model

Finally, pick $B > 0$ so large that

$$\left(\max_{[0, K_2 + \varepsilon]} |f'_{2, \varepsilon}| + d_2 \mu^2 \right) e^{-\mu B} \leq \varepsilon. \quad (7.120)$$

Since $V(+\infty) = K_2$, one can choose $X > 0$ sufficiently large such that

$$V(x) \leq K_2 + \frac{\varepsilon}{2}, \text{ for all } x \geq X.$$

Since $u(t, \cdot) \rightarrow V$ as $t \rightarrow +\infty$ locally uniformly in \mathbb{R} , there is $T > 0$ so large that

$$u(t, X) \leq V(X) + \frac{\varepsilon}{2} \leq K_2 + \varepsilon, \text{ for all } t \geq T.$$

Moreover, since $u(t, x)$ has a Gaussian upper bound for $x > 0$ large enough at each fixed $t > 0$ by Lemma 7.36, whereas $\phi_\varepsilon(s)$ has an exponential bound (similar to (7.13)) as $s \rightarrow +\infty$, there holds (up to increasing B if needed)

$$u(T, x) \leq \phi_\varepsilon(x - X - B - C) + 2\varepsilon \text{ for all } x \geq X. \quad (7.121)$$

For $t \geq T$ and $x \geq X$, let us define

$$\bar{u}(t, x) = \phi_\varepsilon(\bar{\xi}(t, x)) + 2\varepsilon e^{-\varepsilon(t-T)} + 2\varepsilon e^{-\mu(x-X)},$$

where

$$\bar{\xi}(t, x) = x - X - c_{2, \varepsilon}(t - T) + \omega e^{-\varepsilon(t-T)} - \omega - B - C.$$

Let us now check that $\bar{u}(t, x)$ is a supersolution to $u_t = d_2 u_{xx} + f_2(u)$ for all $t \geq T$ and $x \geq X$.

At initial time $t = T$, one has $\bar{u}(T, x) \geq \phi_\varepsilon(x - X - B - C) + 2\varepsilon \geq u(T, x)$ for all $x \geq X$ by (7.121). Moreover, for $x = X$, since $\bar{\xi}(t, X) \leq -B - C < -C$, one deduces that $\bar{u}(t, X) \geq K_2 - \varepsilon + 2\varepsilon e^{-\varepsilon(t-T)} + 2\varepsilon \geq K_2 + \varepsilon \geq u(t, X)$ for all $t \geq T$. Finally, in order to check that $\bar{u}_t(t, x) - d_2 \bar{u}_{xx}(t, x) - f_2(\bar{u}(t, x)) \geq 0$ for all $t \geq T$ and $x \geq X$, it is sufficient to show that $\mathcal{N}\bar{u}(t, x) := \bar{u}_t(t, x) - d_2 \bar{u}_{xx}(t, x) - f_{2, \varepsilon}(\bar{u}(t, x)) \geq 0$ for all $t \geq T$ and $x \geq X$, due to $f_{2, \varepsilon} \geq f_2$ in $\overline{\mathbb{R}}_+$. After a straightforward computation, one derives

$$\begin{aligned} \mathcal{N}\bar{u}(t, x) &= f_{2, \varepsilon}(\phi_\varepsilon(\bar{\xi}(t, x))) - f_{2, \varepsilon}(\bar{u}(t, x)) - \phi'_\varepsilon(\bar{\xi}(t, x)) \omega \varepsilon e^{-\varepsilon(t-T)} \\ &\quad - 2\varepsilon^2 e^{-\varepsilon(t-T)} - 2d_2 \mu^2 \varepsilon e^{-\mu(x-X)}. \end{aligned}$$

We distinguish three cases.

If $\bar{\xi}(t, x) \leq -C$, one has $K_2 - \varepsilon \leq \phi_\varepsilon(\bar{\xi}(t, x)) < K_2$. Hence, $\bar{u}(t, x) \geq K_2 - \varepsilon$. It follows from (7.117) that $f_{2, \varepsilon}(\phi_\varepsilon(\bar{\xi}(t, x))) - f_{2, \varepsilon}(\bar{u}(t, x)) \geq -(f'_{2, \varepsilon}(K_2 + \varepsilon)/2)(2\varepsilon e^{-\varepsilon(t-T)} + 2\varepsilon e^{-\mu(x-X)})$. It then can be deduced from (7.116)–(7.117) as well as the negativity of ϕ'_ε and $f'_{2, \varepsilon}(K_2 + \varepsilon)$

that

$$\begin{aligned} \mathcal{N}\bar{u}(t, x) &\geq -\frac{f'_{2,\varepsilon}(K_2 + \varepsilon)}{2} \left(2\varepsilon e^{-\varepsilon(t-T)} + 2\varepsilon e^{-\mu(x-X)} \right) - 2\varepsilon^2 e^{-\varepsilon(t-T)} - 2d_2\mu^2\varepsilon e^{-\mu(x-X)} \\ &= \left(-\frac{f'_{2,\varepsilon}(K_2 + \varepsilon)}{2} - \varepsilon \right) 2\varepsilon e^{-\varepsilon(t-T)} + \left(-\frac{f'_{2,\varepsilon}(K_2 + \varepsilon)}{2} - d_2\mu^2 \right) 2\varepsilon e^{-\mu(x-X)} > 0. \end{aligned}$$

If $\bar{\xi}(t, x) \geq C$, one derives $0 < \phi_\varepsilon(\bar{\xi}(t, x)) \leq \varepsilon$ and then $\bar{u}(t, x) \leq 5\varepsilon$. It follows from (7.117) that $f_{2,\varepsilon}(\phi_\varepsilon(\bar{\xi}(t, x))) - f_{2,\varepsilon}(\bar{u}(t, x)) \geq -(f'_{2,\varepsilon}(0)/2)(2\varepsilon e^{-\varepsilon(t-T)} + 2\varepsilon e^{-\mu(x-X)})$. By virtue of (7.116)–(7.117) and the negativity of ϕ'_ε and $f'_{2,\varepsilon}(0)$, there holds

$$\begin{aligned} \mathcal{N}\bar{u}(t, x) &\geq -\frac{f'_{2,\varepsilon}(0)}{2} \left(2\varepsilon e^{-\varepsilon(t-T)} + 2\varepsilon e^{-\mu(x-X)} \right) - 2\varepsilon^2 e^{-\varepsilon(t-T)} - 2d_2\mu^2\varepsilon e^{-\mu(x-X)} \\ &= \left(-\frac{f'_{2,\varepsilon}(0)}{2} - \varepsilon \right) 2\varepsilon e^{-\varepsilon(t-T)} + \left(-\frac{f'_{2,\varepsilon}(0)}{2} - d_2\mu^2 \right) 2\varepsilon e^{-\mu(x-X)} > 0. \end{aligned}$$

If $-C \leq \bar{\xi}(t, x) \leq C$, it turns out that $x - X \geq c_{2,\varepsilon}(t - T) - \omega e^{-\varepsilon(t-T)} + \omega + B \geq c_{2,\varepsilon}(t - T) + B$, whence $e^{-\mu(x-X)} \leq e^{-\mu(c_{2,\varepsilon}(t-T)+B)}$. By (7.117)–(7.120), one infers that

$$\begin{aligned} \mathcal{N}\bar{u}(t, x) &\geq -\max_{[0, K_2 + \varepsilon]} |f'_{2,\varepsilon}| \left(2\varepsilon e^{-\varepsilon(t-T)} + 2\varepsilon e^{-\mu(x-X)} \right) + \kappa\omega\varepsilon e^{-\varepsilon(t-T)} \\ &\quad - 2\varepsilon^2 e^{-\varepsilon(t-T)} - 2d_2\mu^2\varepsilon e^{-\mu(x-X)} \\ &\geq \left(\kappa\omega - 2\varepsilon - 2 \max_{[0, K_2 + \varepsilon]} |f'_{2,\varepsilon}| \right) \varepsilon e^{-\varepsilon(t-T)} - \left(\max_{[0, K_2 + \varepsilon]} |f'_{2,\varepsilon}| + d_2\mu^2 \right) 2\varepsilon e^{-\mu(c_{2,\varepsilon}(t-T)+B)} \\ &\geq \left(\kappa\omega - 4\varepsilon - 2 \max_{[0, K_2 + \varepsilon]} |f'_{2,\varepsilon}| \right) \varepsilon e^{-\varepsilon(t-T)} \geq 0. \end{aligned}$$

Consequently, we have proved that $\mathcal{N}\bar{u}(t, x) := \bar{u}_t(t, x) - d_2\bar{u}_{xx}(t, x) - f_{2,\varepsilon}(\bar{u}(t, x)) \geq 0$ for all $t \geq T$ and $x \geq X$. Thus, $\bar{u}_t(t, x) - d_2\bar{u}_{xx}(t, x) - f_{2,\varepsilon}(\bar{u}(t, x)) \geq 0$ for all $t \geq T$ and $x \geq X$. The comparison principle gives that

$$u(t, x) \leq \bar{u}(t, x) = \phi_\varepsilon \left(x - X - c_{2,\varepsilon}(t - T) + \omega e^{-\varepsilon(t-T)} - \omega - B - C \right) + 2\varepsilon e^{-\varepsilon(t-T)} + 2\varepsilon e^{-\mu(x-X)}$$

for all $t \geq T$ and $x \geq X$. Since ε is sufficiently small, one has $\sup_{x \geq ct} u(t, x) \rightarrow 0$ as $t \rightarrow +\infty$ for every $c > 0$. This completes the proof. \square

7.5 The bistable-bistable case

In this section, we only outline the different part of the proofs in the bistable-bistable case, since most of the arguments are similar to the ones in the preceding section.

Proof of Proposition 7.20. Suppose that U is a nonnegative, bounded and classical stationary

7. Propagation and blocking in a two-patch reaction-diffusion model

solution of (7.3) such that $U(-\infty) = K_1$ and $U(+\infty) = 0$. From the strong maximum principle and the Hopf lemma, it follows that $U > 0$ in \mathbb{R} .

Since $U(-\infty) = K_1$, multiplying $d_1 U'' + f_1(U) = 0$ by U' and integrating by parts over $(-\infty, x)$ for any $x \in (-\infty, 0^-]$ yields that

$$\frac{d_1}{2}(U'(x))^2 = \int_{U(x)}^{K_1} f_1(s) ds \geq 0. \quad (7.122)$$

Then, we claim that

$$\begin{cases} \text{either } U > K_1, U' > 0 \text{ in } (-\infty, 0^-], \\ \text{or } U < K_1, U' < 0 \text{ in } (-\infty, 0^-], \\ \text{or } U \equiv K_1 \text{ in } (-\infty, 0]. \end{cases} \quad (7.123)$$

To prove (7.123), we first show that either $U(\cdot) - K_1$ has a strict constant sign in $(-\infty, 0]$ or $U \equiv K_1$ in $(-\infty, 0]$. Indeed, assume that there is $x_0 \in (-\infty, 0^-]$ such that $U(x_0) = K_1$, then (7.122) implies $U'(x_0) = 0$. By the uniqueness of the solution to the initial value problem, one has $U \equiv K_1$ in $(-\infty, 0]$. Assume now that $U(\cdot) - K_1$ has a strict constant sign in $(-\infty, 0]$. Then (7.122) implies that U' has a strict constant sign in $(-\infty, 0^-]$. More precisely, due to $U(-\infty) = K_1$, one concludes that, if $U(0) > K_1$, then $U > K_1$ and $U' > 0$ in $(-\infty, 0^-]$; if $U(0) < K_1$, then $U < K_1$ and $U' < 0$ in $(-\infty, 0^-]$. Our claim (7.123) is achieved.

The argument in patch 2 is exactly the same as the one in the proof of Proposition 7.10. The proof is thereby complete. \square

Propagation with positive or zero speed

Parallel to Lemma 7.28 and Theorem 7.29, we have

Lemma 7.34. *Assume that (7.19) holds and there is $i \in \{1, 2\}$ such that $\int_0^{K_i} f_i(s) ds > 0$. Then there exist $R_i > 0$ and a function ψ_i of class $C^2([-R_i, R_i])$ such that*

$$\begin{cases} d_i \psi_i'' + f_2(\psi_i) = 0, & \text{in } [-R_i, R_i], \\ 0 \leq \psi_i < K_i, & \text{in } [-R_i, R_i], \\ \psi_i = 0, & \text{at } x = \pm R_i, \\ \max_{[-R_i, R_i]} \psi_i = \psi_i(0) > \theta_i. \end{cases} \quad (7.124)$$

Theorem 7.35. *Assume that (7.19) holds and there is $i \in \{1, 2\}$ such that $\int_0^{K_i} f_i(s) ds > 0$. Let $R_i > 0$ and ψ_i be as in Lemma 7.34. Let u be the solution to (7.3) with nonnegative continuous and compactly supported initial function $u_0 \not\equiv 0$. If $u_0 \geq \psi_i(\cdot - x_i)$ in \mathbb{R} for some $|x_i| \geq R_i$, then the conclusion of Theorem 7.26 still holds true.*

Finally, let us sketch the proof of the long time behavior (7.24) of $u(t, x)$ in Theorem 7.27. Since the rest of the proof is the same as that of Theorem 7.17, we omit it here.

Proof of Theorem 7.27. Let u be the solution of (7.3) with nonnegative continuous and compactly supported initial datum $u_0 \not\equiv 0$ satisfying the hypothesis in the statement. By Proposition 7.4, one has $0 < u(t, x) < M := (K_1, K_2, \|u_0\|_{L^\infty(\mathbb{R})})$ for $t > 0$ and $x \in \mathbb{R}$. The conclusion of Theorem 7.26 holds true in patch 1, moreover, the argument of Theorem 7.26 also implies that $u(T, \cdot) > \psi_1(0)$ in $[x_1 - R_1, x_1 + R_1]$ for some $T > 0$ and $x_1 \leq -R_1$, where ψ_1 and $R_1 > 0$ are given as in Lemma 7.34.

Let v and w be, respectively, the solutions of (7.3) with initial data $v(0, \cdot) = \psi_1(\cdot - x_1)$ and $w(0, \cdot) = M$ in \mathbb{R} . Proposition 7.4 implies that

$$0 < v(t, x) < u(t + T, x) < w(t, x) \leq M \text{ for } t > 0 \text{ and } x \in \mathbb{R}.$$

Moreover, v is increasing in time and w is nonincreasing in time. By parabolic estimates, $v(t, \cdot)$ and $w(t, \cdot)$ converge as $t \rightarrow +\infty$, locally uniformly in \mathbb{R} , to stationary solutions p and q of (7.3), respectively. Therefore,

$$0 < p \leq \liminf_{t \rightarrow +\infty} u(t, \cdot) \leq \limsup_{t \rightarrow +\infty} u(t, \cdot) \leq q \leq M \text{ locally uniformly in } \mathbb{R}. \quad (7.125)$$

It is sufficient to show that $p = q$ in \mathbb{R} and $p(+\infty) = q(+\infty) = K_2$. From Theorem 7.35, it follows that v propagates to the left with speed c_1 and $p(-\infty) = K_1$. Hence, $q(-\infty) \geq K_1$. We wish to show that $q(-\infty) = K_1$. Indeed, consider any sequence $(x_n)_{n \in \mathbb{N}}$ such that $x_n \rightarrow -\infty$ as $n \rightarrow +\infty$. By elliptic estimates, up to a subsequence, the function $q_n := q(\cdot + x_n)$ converges in $C_{loc}^2(\mathbb{R})$ to a classical bounded solution q_∞ of $d_1 q_\infty'' + f_1(q_\infty) = 0$ in \mathbb{R} with $q_\infty \geq K_1$ in \mathbb{R} . Let $\vartheta(t)$ be such that $\vartheta'(t) = f_1(\vartheta(t))$ for all $t \geq 0$ and $\vartheta(0) = M$. The comparison principle implies that $q_\infty(x) \leq \vartheta(t)$ for $t \geq 0$ and $x \in \mathbb{R}$. Since $f_1 < 0$ in $(K_1, +\infty)$ and $f_1(K_1) = 0$, one has $\vartheta(t) \searrow K_1$ as $t \rightarrow +\infty$. Thus, $q_\infty \leq K_1$ in \mathbb{R} . Consequently, $q_\infty = K_1$, i.e. $q(-\infty) = K_1$, thanks to the arbitrariness of the sequence $(x_n)_{n \in \mathbb{N}}$. On the other hand, one can show as before that p and q are both stable in $\overline{\mathbb{R}}_+$, whence $p(+\infty) = q(+\infty) = K_2$ by using the approach in Theorem 7.17. Thanks to the uniqueness of the stationary solution of (7.3) connecting K_1 and K_2 given in Proposition 7.22, one has $p = q = V$ in \mathbb{R} . Thus, the large time behavior (7.24) is proved by using (7.125). \square

7.6 Appendix

In this appendix, we give Gaussian upper bounds for solutions to the Cauchy problem (7.3) with compactly supported initial data at each fixed $t > 0$ for all $|x|$ large enough.

7. Propagation and blocking in a two-patch reaction-diffusion model

Assume that f_i ($i = 1, 2$) satisfy the general hypothesis:

$$\exists K > 0, f_1(s) \leq Ks \text{ and } f_2(s) \leq Ks \text{ for all } s \geq 0. \quad (7.126)$$

Lemma 7.36. *Assume that (7.126) holds. Let u be the solution to the Cauchy problem (7.3) with nonnegative continuous and compactly supported initial datum $u_0 \not\equiv 0$ satisfying $\text{spt}(u_0) \subset [-L_1, L_2]$ for some $L_1, L_2 > 0$. Then, we have*

(i) *for every $t_1 > 0$ and for all $x < -L_1$,*

$$u(t_1, x) \leq M e^{Kt_1} e^{-\frac{(x+L_1)^2}{4d_1t_1}};$$

(ii) *for every $t_2 > 0$ and for all $x > L_2$,*

$$u(t_2, x) \leq M e^{Kt_2} e^{-\frac{(x-L_2)^2}{4d_2t_2}},$$

where $M := \max(K_1, K_2, \|u_0\|_{L^\infty(\mathbb{R})})$.

Proof of Lemma 7.36. Let u be the solution to the Cauchy problem (7.3) with nonnegative continuous and compactly supported initial datum $u_0 \not\equiv 0$ satisfying $\text{spt}(u_0) \subset [-L_1, L_2]$. The proof is based on the comparison between u and the solution of certain initial-boundary value problem defined in a half-line. We only sketch the proof for the first statement, since the second one can be handled analogously.

Set $M := \max(K_1, K_2, \|u_0\|_{L^\infty(\mathbb{R})})$. Then by Proposition 7.4, one has $0 < u(t, x) < M$ for $t > 0$ and $x \in \mathbb{R}$. Let v be the solution of the following initial-boundary value problem

$$\begin{cases} v_t = d_1 v_{xx}, & t > 0, x < 0, \\ v(0, x) = M \chi_{[-L_1, 0]}, & x < 0, \\ v(t, 0) = M, & t > 0, \end{cases} \quad (7.127)$$

where χ denotes an indicator function of an interval. By a comparison argument, one has $u(t, x) \leq e^{Kt} v(t, x)$ for all $t \geq 0$ and $x \leq 0$.

To solve (7.127), we define $V(t, x) := v(t, x) - M$ for $t \geq 0$ and $x \leq 0$. Then V satisfies

$$\begin{cases} V_t = d_1 V_{xx}, & t > 0, x < 0, \\ V(0, x) = -M \chi_{(-\infty, -L_1)}, & x < 0, \\ V(t, 0) = 0, & t > 0. \end{cases}$$

By using the odd reflection method, we shall deal with the following initial value problem on

\mathbb{R} :

$$\begin{cases} w_t = d_1 w_{xx}, & t > 0, x \in \mathbb{R}, \\ w(0, x) = V_{\text{odd}}(0, x), & x \in \mathbb{R}, \end{cases}$$

where $V_{\text{odd}}(0, x)$ is the odd extension of $V(0, x)$, that is,

$$V_{\text{odd}}(0, x) = \begin{cases} V(0, x) = -M\chi_{(-\infty, -L_1)}, & x < 0, \\ 0, & x = 0, \\ -V(0, -x) = M\chi_{(L_1, +\infty)}, & x > 0. \end{cases}$$

Denote by S_1 the standard heat kernel:

$$S_1(t, x) = \frac{1}{\sqrt{4\pi d_1 t}} e^{-\frac{x^2}{4d_1 t}} \text{ for } t > 0, x \in \mathbb{R},$$

then for $t > 0$ and $x \in \mathbb{R}$,

$$\begin{aligned} w(t, x) &= \int_{-\infty}^{+\infty} S_1(t, x-y)w(0, y)dy \\ &= \int_{-\infty}^0 S_1(t, x-y)V(0, y)dy - \int_0^{+\infty} S_1(t, x-y)V(0, -y)dy \\ &= \int_{-\infty}^0 (S_1(t, x-y) - S_1(t, x+y))V(0, y)dy. \end{aligned}$$

By noticing that $V(t, x) = w(t, x)|_{x \leq 0}$, it follows that

$$V(t, x) = -\frac{M}{\sqrt{4\pi d_1 t}} \int_{-\infty}^{-L_1} \left(e^{-\frac{(x-y)^2}{4d_1 t}} - e^{-\frac{(x+y)^2}{4d_1 t}} \right) dy.$$

Thus, the solution of problem (7.127) reads

$$\begin{aligned} v(t, x) &= M + V(t, x) \\ &= M - \frac{M}{\sqrt{4\pi d_1 t}} \int_{-\infty}^{-L_1} \left(e^{-\frac{(x-y)^2}{4d_1 t}} - e^{-\frac{(x+y)^2}{4d_1 t}} \right) dy \\ &= M \left(1 - \frac{1}{\sqrt{\pi}} \int_{-\infty}^{\frac{-x-L_1}{\sqrt{4d_1 t}}} e^{-z^2} dz + \frac{1}{\sqrt{\pi}} \int_{-\infty}^{\frac{x-L_1}{\sqrt{4d_1 t}}} e^{-z^2} dz \right) \\ &= M \left(1 - \frac{1}{2} \operatorname{erf} \left(\frac{-x-L_1}{\sqrt{4d_1 t}} \right) - \frac{1}{2} \operatorname{erf} \left(\frac{L_1-x}{\sqrt{4d_1 t}} \right) \right), \end{aligned}$$

where $\operatorname{erf}(z)$ and $\operatorname{erfc}(z) = 1 - \operatorname{erf}(z)$ denote the error function and the complementary error

7. Propagation and blocking in a two-patch reaction-diffusion model

function, respectively, given by

$$\operatorname{erf}(x) := \frac{2}{\sqrt{\pi}} \int_0^x e^{-s^2} ds, \quad \operatorname{erfc}(x) := \frac{2}{\sqrt{\pi}} \int_x^{+\infty} e^{-s^2} ds.$$

Hence, for any $t_1 > 0$ and $x < -L_1$, there holds

$$\begin{aligned} u(t_1, x) &\leq e^{Kt_1} v(t_1, x) = e^{Kt_1} M \left(1 - \frac{1}{2} \operatorname{erf} \left(\frac{-x - L_1}{\sqrt{4d_1 t_1}} \right) - \frac{1}{2} \operatorname{erf} \left(\frac{L_1 - x}{\sqrt{4d_1 t_1}} \right) \right) \\ &\leq e^{Kt_1} M \left(1 - \operatorname{erf} \left(\frac{-x - L_1}{\sqrt{4d_1 t_1}} \right) \right) \\ &= e^{Kt_1} M \operatorname{erfc} \left(\frac{-x - L_1}{\sqrt{4d_1 t_1}} \right) \\ &\leq e^{Kt_1} M e^{-\frac{(x+L_1)^2}{4d_1 t_1}}, \end{aligned}$$

where we have used the exponential-type upper bound $\operatorname{erfc}(x) \leq e^{-x^2}$ for $x > 0$ in the last inequality. This completes the proof. \square

Bibliography

- [1] D. Addona, C.-M. Brauner, L. Lorenzi, W. Zhang, *Instabilities in a combustion model with two free interfaces*, J. Differential Equations, 268 (2020), 396–4016.
- [2] R.K. Alexander, B.A. Fleishman, *Perturbation and bifurcation in a free boundary problem*, J. Differential Equations 45 (1982), 34–52.
- [3] L. Almeida, J. Estrada, N. Vauchelet, *The sterile insect technique used as a barrier control against reinfestation*, arXiv preprint (2020), arXiv:2005.11944.
- [4] Y. Alqawasmeh, F. Lutscher, *Movement behaviour of fish, harvesting-induced habitat degradation and the optimal size of marine reserves*, Theor. Ecol. 12 (2019), 453–466.
- [5] Y. Alqawasmeh, F. Lutscher, *Persistence and spread of stage-structured populations in heterogeneous landscapes*, J. Math. Biol. 78 (2019), 1485–1527.
- [6] H. Amann, *Fixed point equations and nonlinear eigenvalue problems in ordered Banach spaces*, SIAM Review, 18 (1976), 620–709.
- [7] D. G. Aronson, N. V. Mantzaris, H. G. Othmer, *Wave propagation and blocking in inhomogeneous media*, Discrete Contin. Dyn. Syst. Ser. A, 13 (2005), 843–876.
- [8] D. G. Aronson, H. F. Weinberger, *Nonlinear diffusion in population genetics, combustion and nerve propagation*, In: Partial Differential Equations and Related Topics, Lecture Notes in Math 446, Springer, New York (1975), 5–49.
- [9] D.G. Aronson, H. F. Weinberger, *Multidimensional nonlinear diffusions arising in population genetics*, Adv. Math. 30 (1978), 33–76.
- [10] R. Ashman, E. Hull, *Essentials of Electrocardiography*. New York: Macmillan, 1945.
- [11] H. Berestycki, J. Bouhours, G. Chapuisat, *Front blocking and propagation in cylinders with varying cross section*, Calc. Var. Part. Diff. Equations 55 (2016), 1–32.
- [12] H. Berestycki, L. Caffarelli, L. Nirenberg, *Further qualitative properties for elliptic equations in unbounded domains*, Ann. Scuola Norm. Sup. Pisa Cl. Sci. (4) 5 (1997), 69–94.
- [13] H. Berestycki, A.-C. Coulon, J.-M. Roquejoffre and L. Rossi, *Speed-up of reaction-diffusion fronts by a line of fast diffusion*, Séminaire Laurent Schwartz– EDP et applications, 25 (2013–2014), 1–25.
- [14] H. Berestycki, A.-C. Coulon, J.-M. Roquejoffre and L. Rossi, *The effect of a line with nonlocal diffusion on Fisher-KPP propagation*, Math. Models Methods Appl. Sci. 25 (2015), 2519–2562.

-
- [15] H. Berestycki, R. Ducasse, and L. Rossi, *Generalized principal eigenvalues for heterogeneous road-field systems*, Commun. Contemp. Math. 22 (2020), 1950013.
- [16] H. Berestycki, R. Ducasse, and L. Rossi, *Influence of a road on a population in an ecological niche facing climate change*, J. Math. Biol. 81 (2020), 1059–1097.
- [17] H. Berestycki, F. Hamel, *Front propagation in periodic excitable media*, Comm. Pure Appl. Math. 55 (2002), 949–1032.
- [18] H. Berestycki, F. Hamel, *Generalized travelling waves for reaction-diffusion equations*, In: *Perspectives in Nonlinear Partial Differential Equations. In honor of H. Brezis*, Amer. Math. Soc. Contemp. Math. 446 (2007), 101–123.
- [19] H. Berestycki, F. Hamel, *Generalized transition waves and their properties*, Comm. Pure Appl. Math. 65 (2012), 592–648.
- [20] H. Berestycki, F. Hamel, H. Matano, *Bistable traveling waves around an obstacle*, Comm. Pure Appl. Math. 62 (2009), 729–788.
- [21] H. Berestycki, F. Hamel, G. Nadin, *Asymptotic spreading in heterogeneous diffusive media*, J. Funct. Anal. 255 (2008), 2146–2189.
- [22] H. Berestycki, F. Hamel, N. Nadirashvili, *The speed of propagation for KPP type problems. I - periodic framework*, J. Europ. Math. Soc. 7 (2005), 173–213.
- [23] H. Berestycki, F. Hamel, and N. Nadirashvili, *The speed of propagation for KPP type problems. II. General domains.*, J. Amer. Math. Soc. 23 (2010), 1–34.
- [24] H. Berestycki, F. Hamel, L. Roques, *Analysis of the periodically fragmented environment model: I-Species persistence*, J. Math. Biol. 51 (2005), 75–113.
- [25] H. Berestycki, F. Hamel, L. Roques, *Analysis of the periodically fragmented environment model: II-Biological invasions and pulsating travelling fronts*, J. Math. Pures Appl. 84 (2005), 1101–1146.
- [26] H. Berestycki, P.-L. Lions, *Une méthode locale pour l'existence de solutions positives de problèmes semi-linéaires elliptiques dans \mathbb{R}^N* , J. Anal. Math. 38 (1980), 144–187.
- [27] H. Berestycki, G. Nadin, *Spreading speeds for one-dimensional monostable reaction-diffusion equations*, J. Math. Phys. 53 (2012), 115619.
- [28] H. Berestycki, B. Nicolaenko, B. Scheurer, *Traveling wave solutions to combustion models and their singular limits*, SIAM J. Math. Anal. 16 (1985), 1207–1242.
- [29] H. Berestycki, N. Rodríguez, L. Ryzhik, *Traveling wave solutions in a reaction-diffusion model for criminal activity*, SIAM Multi. Model. Simul. 11 (2013), 1097–1126.
- [30] H. Berestycki, J.-M. Roquejoffre and L. Rossi, *The influence of a line with fast diffusion on Fisher-KPP propagation*, J. Math. Biol. 66 (2013), 743–766.
- [31] H. Berestycki, J.-M. Roquejoffre and L. Rossi, *Fisher-KPP propagation in the presence of a line: Further effects*, Nonlinearity, 26 (2013), 2623–2640.

-
- [32] H. Berestycki, J.-M. Roquejoffre and L. Rossi, *The shape of expansion induced by a line with fast diffusion in Fisher-KPP equations*, Comm. Math. Phys. 343 (2016), 207–232.
- [33] H. Berestycki, J.-M. Roquejoffre and L. Rossi, *Travelling waves, spreading and extinction for Fisher-KPP propagation driven by a line with fast diffusion*, Nonlinear Anal. 137 (2016), 171–189.
- [34] B. Bogosel, T. Giletti, A. Tellini, *Propagation for KPP bulk-surface systems in a general cylindrical domain*, arXiv:2006.14224.
- [35] I. Brailovsky, P.V. Gordon, L. Kagan, G.I. Sivashinsky, *Diffusive-thermal instabilities in premixed flames: Stepwise ignition-temperature kinetics*, Combust. Flame 162 (2015), 101–124.
- [36] M. Bramson, *Convergence of solutions of the Kolmogorov equation to travelling waves*, Memoirs Amers. Math. Soc. 44, 1983.
- [37] C.-M. Brauner, P.V. Gordon, W. Zhang, *An ignition-temperature model with two free interfaces in premixed flames*, Combust. Theory Model. 20 (2016), 976–994.
- [38] C.-M. Brauner, L. Hu, L. Lorenzi, *Asymptotic analysis in a gas-solid combustion model with pattern formation*, Chin. Ann. Math. Ser. B 34 (2013), 65–88.
- [39] C.-M. Brauner, J. Hulshof, L. Lorenzi, *Stability of the Travelling Wave in a 2D weakly nonlinear Stefan problem*, Kinet. Relat. Models 2 (2009), 109–134.
- [40] C.-M. Brauner, J. Hulshof, L. Lorenzi, *Rigorous derivation of the Kuramoto-Sivashinsky equation in a 2D weakly nonlinear Stefan problem*, Interfaces Free Bound. 13 (2011), 73–103.
- [41] C.-M. Brauner, J. Hulshof, L. Lorenzi, G. Sivashinsky, *A fully nonlinear equation for the flame front in a quasi-steady combustion model*, Discrete Contin. Dyn. Syst. 27 (2010), 1415–1446.
- [42] C.-M. Brauner, J. Hulshof, A. Lunardi, *A general approach to stability in free boundary problems*, J. Differential Equations 164 (2000), 16–48.
- [43] C.-M. Brauner, L. Lorenzi, *Local existence in free interface problems with underlying second-order Stefan condition*, Rev. Roumaine Math. Pures Appl. 23 (2018), 339–359.
- [44] C.-M. Brauner, L. Lorenzi, G.I. Sivashinsky, C.-J. Xu, *On a strongly damped wave equation for the flame front*, Chin. Ann. Math. Ser. B 31 (2010), 819–840.
- [45] C.-M. Brauner, A. Lunardi, C. Schmidt-Lainé, *Stability of travelling waves with interface conditions*, Nonlinear Anal. 19 (1992), 465–484.
- [46] P. Brunovský, P. Poláčik, B. Sandstede, *Convergence in general periodic parabolic equations in one space dimension*, Nonlinear Anal. 18 (1992), 209–215.
- [47] J. G. Caputo, B. Sarels, *Reaction-diffusion front crossing a local defect*, Phys. Rev. E. 84 (2011), 041108.
- [48] K.-C. Chang, *The obstacle problem and partial differential equations with discontinuous nonlinearities*, Comm. Pure Appl. Math. 33 (1980), 117–146.

-
- [49] G. Chapuisat, E. Grenier, *Existence and non-existence of progressive wave solutions for a bistable reaction-diffusion equation in an infinite cylinder whose diameter is suddenly increased*, Comm. Part. Diff. Equations 30 (2005), 1805–1816.
- [50] M. Chipot, *Elliptic Equations: An Introductory Course*, Birkhäuser, Basel, Birkhäuser Advanced Texts, 2009.
- [51] M. Chipot, *Asymptotic Issues for Some Partial Differential Equations*, Imperial College Press, London, 2016.
- [52] M. Chipot, M. Zhang, *On some model problem for the propagation of interacting species in a special environment*, Discrete Contin. Dyn. Syst., 41 (2021), 3141–3161.
- [53] P. G. Ciarlet, *Linear and Nonlinear Functional Analysis with Applications*, SIAM, Philadelphia, 2013.
- [54] C. Cobbold, F. Lutscher, J. Sherratt, *Complex spatial patterns result from the Turing mechanism in a patchy landscape*, Ecol. Complexity 24 (2015), 69–81.
- [55] J.B. Conway, *Functions of one complex variable*, Springer-Verlag, 1978.
- [56] R. Dautray and J.-L. Lions, *Analyse Mathématique et Calcul Numérique pour les Sciences et les Techniques*, Tome 1, Masson, Paris, 1985.
- [57] L. Dietrich, *Existence of travelling waves for a reaction-diffusion system with a line of fast diffusion*, Appl. Math. Res. Express. AMRX, 2 (2015), 204–252.
- [58] L. Dietrich, *Velocity enhancement of reaction-diffusion fronts by a line of fast diffusion*, Trans. Amer. Math. Soc. 369 (2017), 3221–3252.
- [59] W. Ding, F. Hamel, X.-Q. Zhao, *Propagation phenomena for periodic bistable reaction-diffusion equations*, Calc. Var. Part. Diff. Equations 54 (2015), 2517–2551.
- [60] J. Dowdall, V. LeBlanc, F. Lutscher, *Invasion pinning in a periodically fragmented habitat*, J. Math. Biol. 77 (2018), 55–78.
- [61] Y. Du, H. Matano, *Convergence and sharp thresholds for propagation in nonlinear diffusion problems*, J. Eur. Math. Soc. 12 (2010), 279–312.
- [62] Y. Du, P. Poláčik, *Locally uniform convergence to an equilibrium for nonlinear parabolic equations on \mathbb{R}^N* , Indiana Univ. Math. J. 64 (2015), 787–824.
- [63] R. Ducasse, *Influence of the geometry on a field-road model: the case of a conical field*, J. Lond. Math. Soc. (2) 97 (2018), 441–469.
- [64] R. Ducasse, L. Rossi, *Blocking and invasion for reaction-diffusion equations in periodic media*, Calc. Var. Part. Differ. Equations 57, 142 (2018).
- [65] A. Ducrot, *A multi-dimensional bistable nonlinear diffusion equation in a periodic medium*, Math. Ann. 366 (2016), 783–818.

-
- [66] A. Ducrot, T. Giletti, H. Matano, *Existence and convergence to a propagating terrace in one-dimensional reaction-diffusion equations*, Trans. Amer. Math. Soc. 366 (2014), 5541–5566.
- [67] L. Dupaigne, *Stable Solutions of Elliptic Partial Differential Equations*, Monographs and Surveys in Pure and Applied Mathematics 143, Chapman & Hall, 2011.
- [68] S. Eberle, *A heteroclinic orbit connecting traveling waves pertaining to different nonlinearities*, Nonlin. Anal. 172 (2018), 99–114.
- [69] S. Eberle, *Front blocking in the presence of gradient drift*, J. Diff. Equations 267 (2019), 7154–7166.
- [70] S. Eberle, *Front blocking versus propagation in the presence of drift term in the direction of propagation*, Nonlin. Anal. 197 (2020), 111836.
- [71] C. Elliot and J. R. Ockendon, *Weak and variational methods for moving boundary problems*, Pitman, London, 1985.
- [72] M. El Smaily, *Min-max formulas for the speeds of pulsating travelling fronts in periodic excitable media*, Ann. Mat. Pura Appl. 189 (2010), 47–66.
- [73] L. C. Evans, *Partial Differential Equations*, Volume 19 of *Graduate Studies in Mathematics*, American Mathematical Society, 2nd edition, 2010.
- [74] J. Fang, X.-Q. Zhao, *Bistable waves for monotone semiflows with applications*, J. Europ. Math. Soc. 17 (2015), 2243–2288.
- [75] P. C. Fife, *Mathematical aspects of reacting and diffusing systems*, Lecture Notes in Biomath. 28, Springer, 1979.
- [76] P. C. Fife, B. McLeod, *The approach of solutions of nonlinear diffusion equations to traveling front solutions*, Arch. Ration. Mech. Anal. 65 (1977), 335–361.
- [77] R. A. Fisher, *The advance of advantageous genes*, Ann. of Eugenics, 7 (1937), 355–369.
- [78] F.R. Gantmakher, *The theory of matrices*, Reprint of the 1959 translation. AMS Chelsea Publishing, Providence, RI, 1998.
- [79] A. Ghazaryan, C.K.R.T. Jones, *On the stability of high Lewis number combustion fronts*, Discrete Contin. Dyn. Syst. 24 (2009), 809–826.
- [80] A. Ghazaryan, Y. Latushkin, S. Schecter, *Stability of traveling waves for a class of reaction-diffusion systems that arise in chemical reaction models*, SIAM J. Math. Anal. 42 (2010), 2434–2472.
- [81] J. Garnier, T. Giletti, G. Nadin, *Maximal et minimal spreading speeds for reaction diffusion equations in nonperiodic slowly varying media*, J. Dynam. Diff. Equations 24 (2012), 521–538.
- [82] B. Gidas, W.-M. Ni, L. Nirenberg, *Symmetry of positive solutions of nonlinear elliptic equations in \mathbb{R}^n and related properties via the maximum principle*, Comm. Math. Phys. 68 (1979), 209–243.
- [83] D. Gilbarg and N. S. Trudinger, *Elliptic Partial Differential Equations of Second Order*, Springer-Verlag, Berlin, 2001.

-
- [84] T. Giletti, L. Monsaingeon, and M. Zhou, *A KPP road-field system with spatially periodic exchange terms*, *Nonlinear Anal.* 128 (2015), 273–302.
- [85] T. Giletti, L. Rossi, *Pulsating solutions for multidimensional bistable and multistable equations*, *Math. Ann.* 378 (2020), 1555–1611.
- [86] P. Grindrod, M. A. Lewis, *One-way blocks in cardiac tissue: a mechanism for propagation failure in Purkinje fibres*, *Bull. Math. Biol.* 53 (1991), 881–899.
- [87] H. Guo, *Transition fronts in unbounded domains with multiple branches*, *Calc. Var. Part. Diff. Equations* 59 (2020), 160.
- [88] H. Guo, F. Hamel and W. Sheng, *On the mean speed of bistable transition fronts in unbounded domains*, *J. Math. Pures Appl.* 136 (2020) 92–157.
- [89] H. Guo, H. Monobe, *V-shaped fronts around an obstacle*, *Math. Ann.* 379 (2021), 661–689.
- [90] J.-S. Guo, F. Hamel, *Propagation and blocking in periodically hostile environments*, *Arch. Ration. Mech. Anal.* 204 (2012), 945–975.
- [91] F. Hamel, *Qualitative properties of KPP and monostable fronts: monotonicity and exponential decay*, *J. Math. Pures Appl.* 89 (2008), 355–399.
- [92] F. Hamel, *Bistable transition fronts in \mathbb{R}^N* , *Adv. Math.* 289 (2016), 279–344.
- [93] F. Hamel, J. Fayard and L. Roques, *Spreading speeds in slowly oscillating environments*, *Bull. Math. Biol.* 72 (2010), 1166–1191.
- [94] F. Hamel, F. Lutscher, M. Zhang, *Propagation phenomena in periodic patchy landscapes with interface conditions*, <https://hal.archives-ouvertes.fr/hal-03271633/document> (2021).
- [95] F. Hamel, F. Lutscher, M. Zhang, *Propagation phenomena in an environment with two patches*, in preparation.
- [96] F. Hamel, G. Nadin, *Diameters of the level sets for reaction-diffusion equations in nonperiodic slowly varying media*, <https://hal.archives-ouvertes.fr/hal-03226102/document> (2021).
- [97] F. Hamel, J. Nolen, J.-M. Roquejoffre, L. Ryzhik, *A short proof of the logarithmic Bramson correction in Fisher-KPP equations*, *Netw. Heterog. Media* 8 (2013), 275–289.
- [98] F. Hamel, and L. Roques, *Uniqueness and stability properties of monostable pulsating fronts*, *J. Eur. Math. Soc.* 13 (2011), 345–390.
- [99] F. Hamel, L. Rossi, *Transition fronts for the Fisher-KPP equation*, *Trans. Amer. Math. Soc.* 368 (2016), 8675–8713.
- [100] F. Hamel, M. Zhang, *Reaction-diffusion fronts in funnel-shaped domains*, 2021, Hal-03141436.
- [101] D. Henry, *Geometric theory of semilinear parabolic equations*, *Lectures Notes in Math.* Springer Verlag, New York, 1981.

-
- [102] J. Huang, W. Shen, *Speeds of spread and propagation for KPP models in time almost and space periodic media*, SIAM J. Appl. Dyn. Syst. 8 (2009), 790–821.
- [103] W. Hudson, B. Zinner, *Existence of traveling waves for reaction-diffusion equations of Fisher type in periodic media*, In: Boundary Value Problems for Functional-Differential Equations. J. Henderson (ed.), World Scientific, 187–199, 1995.
- [104] S. Jimbo, Y. Morita, *Entire solutions to reaction-diffusion equations in multiple half-lines with a junction*, J. Diff. Equations 267 (2019), 1247–1276.
- [105] Ya. I. Kanel', *Certain problems of burning-theory equations*, Soviet Math. Dokl. 2 (1961), 48–51.
- [106] Ya. I. Kanel', *Stabilization of solution of the Cauchy problem for equations encountered in combustion theory*, Mat. Sbornik 59 (1962), 245–288.
- [107] Ya. I. Kanel', *Stabilization of the solutions of the equations of combustion theory with finite initial functions*, Mat. Sb. (N.S.) 65 (1964), 398–413.
- [108] A. N. Kolmogorov, I. G. Petrovskii, and N. S. Piskunov, *Étude de l'équation de la chaleur de matière et son application à un problème biologique*, Bull. Moskov. Gos. Univ. Mat. Mekh. 1 (1937), 1–25.
- [109] K.-S. Lau, *On the nonlinear diffusion equation of Kolmogorov, Petrovsky, and Piskunov*, J. Diff. Equations 59 (1985), 44–70.
- [110] T. J. Lewis, J. P. Keener, *Wave-block in excitable media due to regions of depressed excitability*, SIAM J. Appl. Math. 61 (2000), 293–316.
- [111] H. Li, X. Wang, *Using effective boundary conditions to model fast diffusion on a road in a large field*, Nonlinearity 30 (2017), 3853–3894.
- [112] G. M. Lieberman, *Second Order Parabolic Differential Equations*, World Scientific, 1996.
- [113] X. Liang and X.-Q. Zhao, *Asymptotic speeds of spread and traveling waves for monotone semiflows with applications*, Comm. Pure Appl. Math. 60 (2007), 1–40.
- [114] X. Liang and X.-Q. Zhao, *Spreading speeds and traveling waves for abstract monostable evolution systems*, J. Funct. Anal. 259 (2010), 857–903.
- [115] L. Lorenzi, *A free boundary problem stemmed from combustion theory. I. Existence, uniqueness and regularity results*, J. Math. Anal. Appl. 274 (2002), 505–535.
- [116] L. Lorenzi, *A free boundary problem stemmed from combustion theory. II. Stability, instability and bifurcation results*, J. Math. Anal. Appl. 275 (2002), 131–160.
- [117] L. Lorenzi, *Bifurcation of codimension two in a combustion model*, Adv. Math. Sci. Appl. 14 (2004), 483–512.
- [118] B. Lou, H. Matano, K.-I. Nakamura, *Recurrent traveling waves in a two-dimensional saw-toothed cylinder and their average speed*, J. Diff. Equations 255 (2013), 3357–3411.
- [119] A. Lunardi, *Analytic semigroups and optimal regularity in parabolic problems*, Birkhäuser, Basel, 1996.

-
- [120] G. Maciel, C. Cosner, R.S. Cantrell, F. Lutscher, *Evolutionarily stable movement strategies in reaction-diffusion models with edge behavior*, J. Math. Biol. 80 (2020), 61–92.
- [121] G. A. Maciel, F. Lutscher, *How individual movement response to habitat edges affects population persistence and spatial spread*, Am. Nat. 182 (2013), 42–52.
- [122] G. A. Maciel, F. Lutscher, *Allee effects and population spread in patchy landscapes*, J. Biol. Dyn. 9 (2015), 109–123.
- [123] G. A. Maciel, F. Lutscher, *Movement behavior determines competitive outcome and spread rates in strongly heterogeneous landscapes*, Theor. Ecol. 11 (2018), 351–365.
- [124] H. Matano, *Traveling waves in spatially random media*, RIMS Kokyuroku 1337 (2003), 1–9.
- [125] H. Matano, K.-I. Nakamura, B. Lou, *Periodic traveling waves in a two-dimensional cylinder with saw-toothed boundary and their homogenization limit*, Netw. Heterog. Media 1 (2006), 537–568.
- [126] B.J. Matkowsky, G.I. Sivashinsky, *An asymptotic derivation of two models in flame theory associated with the constant density approximation*, SIAM J. Appl. Math. 37 (1979), 686–699.
- [127] G. Nadin, *Critical travelling waves for general heterogeneous one-dimensional reaction-diffusion equations*, Ann. Inst. H. Poincaré Anal. Non Linéaire 32 (2015), 841–873.
- [128] G. Nadin, *Travelling fronts in space-time periodic media*, J. Math. Pures Appl. 92 (2009), 232–262.
- [129] G. Namah, J.-M. Roquejoffre, *Convergence to periodic fronts in a class of semilinear parabolic equations*, NoDEA Nonlinear Differential Equations Appl. 4 (1997), 521–536.
- [130] J. Nolen, M. Rudd, J. Xin, *Existence of KPP fronts in spatially-temporally periodic advection and variational principle for propagation speeds*, Dyn. Part. Diff. Equations 2 (2005), 1–24.
- [131] J. Nolen, J. Xin, *Existence of KPP type fronts in space-time periodic shear flows and a study of minimal speeds based on variational principle*, Disc. Cont. Dyn. Syst. 13 (2005), 1217–1234.
- [132] J.R. Ockendon, *Linear and nonlinear stability of a class of moving boundary problems*, in *Free Boundary Problems: Volume II* (E. Magenes, Ed.), Instituto Nazionale di Alta Matematica Francesco Severi, Rome, 443–478, 1980.
- [133] O. Ovaskainen, S. J. Cornell, *Biased movement at a boundary and conditional occupancy times for diffusion processes*, J. Appl. Probab. 40 (2003), 557–580.
- [134] A. Pauthier, *Uniform dynamics for Fisher-KPP propagation driven by a line of fast diffusion under a singular limit*, Nonlinearity, 28 (2015), 3891–3920.
- [135] A. Pauthier, *The influence of nonlocal exchange terms on Fisher-KPP propagation driven by a line of fast diffusion*, Commun. Math. Sci. 14 (2016), 535–570.
- [136] A. Pauthier, *Entire solution in cylinder-like domains for a bistable reaction-diffusion equation*, J. Dyn. Diff. Equations 30 (2018), 1273–1293.
- [137] J.P. Pauwelussen, *Nerve impulse propagation in a branching nerve system: a simple model*, Phys. D 4 (1981), 67–88.

-
- [138] A. Pazy, *Semigroups of linear operators and applications to partial differential equations*, In: Applied mathematical sciences, vol 44. Springer, Berlin, 1983.
- [139] L. Roques, A. Roques, H. Berestycki, A. Kretzschmar, *A population facing climate change: joint influences of Allee effects and environmental boundary geometry*, Pop. Ecology 50 (2008), 215–225.
- [140] L. Rossi, A. Tellini, E. Valdinoci, *The effect on Fisher-KPP propagation in a cylinder with fast diffusion on the boundary*, SIAM J. Math. Anal. 49 (2017), 4595–4624.
- [141] W. Rudin, *Principles of Mathematical Analysis*, 3rd edn. (McGraw-Hill Book Company, Inc., New York-Toronto-London, 1976).
- [142] D.H. Sattinger, *On the stability of waves of nonlinear parabolic systems*, Adv. Math. 22 (1976), 312–355.
- [143] G. Sell, Y. You, *Dynamics of evolutionary equations*, In: Applied mathematical sciences, vol 143. Springer, Berlin, 2002.
- [144] W. Shen, *Variational principle for spreading speeds and generalized propagating speeds in time almost periodic and space periodic KPP models*, Trans. Amer. Math. Soc. 362 (2010), 5125–5168.
- [145] N. Shigesada, K. Kawasaki, *Biological invasions: theory and practice*, Oxford Series in Ecology and Evolution, Oxford: Oxford University Press, 1997.
- [146] N. Shigesada, K. Kawasaki, E. Teramoto, *Traveling periodic waves in heterogeneous environments*, Theor. Population Biol. 30 (1986), 143–160.
- [147] N. Shigesada, K. Kawasaki, H. F. Weinberger, *Spreading speeds of invasive species in a periodic patchy environment: effects of dispersal based on local information and gradient-based taxis*, Japan J. Indust. Appl. Math. 32 (2015), 675–705.
- [148] G.I. Sivashinsky, *On flame propagation under condition of stoichiometry*, SIAM J. Appl. Math. 39 (1980), 67–82.
- [149] J. G. Skellam, *Random dispersal in theoretical populations*, Biometrika 38, 196–218, 1951.
- [150] H. L. Smith, *Monotone Dynamical Systems*, an introduction to the theory of competitive and cooperative systems, Math. Surveys & Monographs, No. 41, American Mathematical Society, Providence, Rhode Island (1995).
- [151] J. Sneyd, J. Sherratt, *On the propagation of calcium waves in an inhomogeneous medium*, SIAM J. Appl. Math. 57 (1997), 73–94.
- [152] A. Tellini, *Propagation speed in a strip bounded by a line with different diffusion*, J. Diff. Equations, 260 (2016), 5956–5986.
- [153] K. Uchiyama, *The behavior of solutions of some nonlinear diffusion equations for large time*, J. Math. Kyoto Univ. 18 (1978), 453–508.
- [154] K. Uchiyama, *Asymptotic behavior of solutions of reaction-diffusion equations with varying drift coefficients*, Arch. Ration. Mech. Anal. 90 (1985), 291–311.

-
- [155] H. F. Weinberger, *On spreading speeds and traveling waves for growth and migration models in a periodic habitat*, J. Math. Biol. 45(2002), 511–548.
- [156] X. Xin, *Existence and stability of travelling waves in periodic media governed by a bistable nonlinearity*, J. Dyn. Diff. Equations 3 (1991), 541–573.
- [157] X. Xin, *Existence of planar flame fronts in convective-diffusive periodic media*, Arch. Ration. Mech. Anal. 121 (1992), 205–233.
- [158] J. X. Xin, *Existence and nonexistence of traveling waves and reaction-diffusion front propagation in periodic media*, J. Statist. Phys. 73 (1993), 893–926.
- [159] J. X. Xin, *Analysis and modeling of front propagation in heterogeneous media*, SIAM Review 42 (2000), 161–230.
- [160] J. X. Xin, J. Zhu, *Quenching and propagation of bistable reaction-diffusion fronts in multidimensional periodic media*, Physica D 81 (1995), 94–110.
- [161] S.-M. Zheng, *Nonlinear evolution equations*, Pitman Monographs and Surveys in Pure and Applied Mathematics, 133, Chapman & Hall/CRC, Boca Raton, Florida, 2004.
- [162] A. Zlatoš, *Sharp transition between extinction and propagation of reaction*, J. Am. Math. Soc. 19 (2006), 251–263.
- [163] A. Zlatoš, *Transition fronts in inhomogeneous Fisher-KPP reaction-diffusion equations*, J. Math. Pures Appl. 98 (2012), 89–102.
- [164] A. Zlatoš, *Existence and non-existence of transition fronts for bistable and ignition reactions*, Ann. Inst. H. Poincaré Anal. Non Linéaire 34 (2017), 1687–1705.

